

Automotive high voltage power Schottky rectifier

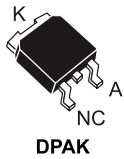
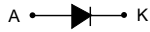

Features

- AEC-Q101 qualified
- Negligible switching losses
- High junction temperature capability
- Low leakage current
- Good trade-off between leakage current and forward voltage drop
- Avalanche specification
- PPAP capable
- V_{RRM} guaranteed from -40 °C to $+175\text{ °C}$

Description

The **STPS5H100-Y** is housed in a DPAK package. This high voltage Schottky barrier rectifier is designed for high frequency miniature switched mode power supplies and on board DC to DC converters for automotive applications.

It is ideally suited for LED lighting and car radio applications, as well as ECU (Engine Control Unit) in automotive environment.

Product status link	
STPS5H100-Y	
Product summary	
Symbol	Value
$I_{F(AV)}$	5 A
V_{RRM}	100 V
T_j range	-40 °C to $+175\text{ °C}$
V_F (max.)	0.61 V

1 Characteristics

Table 1. Absolute ratings (limiting values at 25 °C, unless otherwise specified)

Symbol	Parameter		Value	Unit
V _{RRM}	Repetitive peak reverse voltage, T _j = -40 °C to +175 °C		100	V
I _{F(RMS)}	Forward rms current		10	A
I _{F(AV)}	Average forward current	T _c = 165 °C, δ = 0.5	5	A
I _{FSM}	Surge non repetitive forward current	t _p = 10 ms sinusoidal	75	A
P _{ARM}	Repetitive peak avalanche power	t _p = 10 μs, T _j = 125 °C	518	W
T _{stg}	Storage temperature range		-65 to +175	°C
T _j	Operating junction temperature range ⁽¹⁾		-40 to +175	°C

1. $(dP_{tot}/dT_j) < (1/R_{th(j-a)})$ condition to avoid thermal runaway for a diode on its own heatsink.

Table 2. Thermal parameters

Symbol	Parameter	Max. value	Unit
R _{th(j-c)}	Junction to case	2.5	°C/W

Table 3. Static electrical characteristics

Symbol	Parameter	Test conditions		Min.	Typ.	Max.	Unit
I _R ⁽¹⁾	Reverse leakage current	T _j = 25 °C	V _R = V _{RRM}	-		3.5	μA
		T _j = 125 °C		-	1.3	4.5	mA
V _F ⁽²⁾	Forward voltage drop	T _j = 25 °C	I _F = 5 A	-		0.73	V
		T _j = 125 °C		-	0.57	0.61	
		T _j = 25 °C	I _F = 10 A	-		0.85	
		T _j = 125 °C		-	0.66	0.71	

1. Pulse test: t_p = 5 ms, δ < 2%

2. Pulse test: t_p = 380 μs, δ < 2%

To evaluate the conduction losses, use the following equation:

$$P = 0.51 \times I_{F(AV)} + 0.02 \times I_{F(RMS)}^2$$

1.1 Characteristics (curves)

Figure 1. Average forward power dissipation versus average forward current

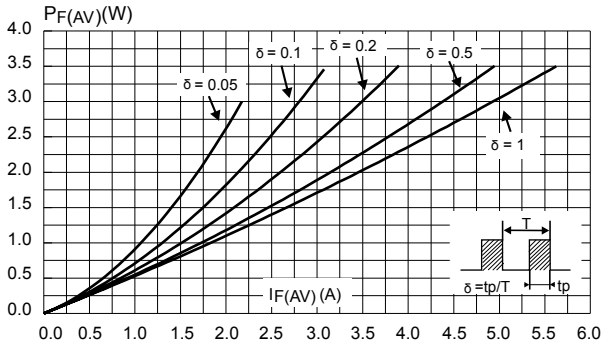

Figure 2. Average forward current versus ambient temperature ($\delta = 0.5$)

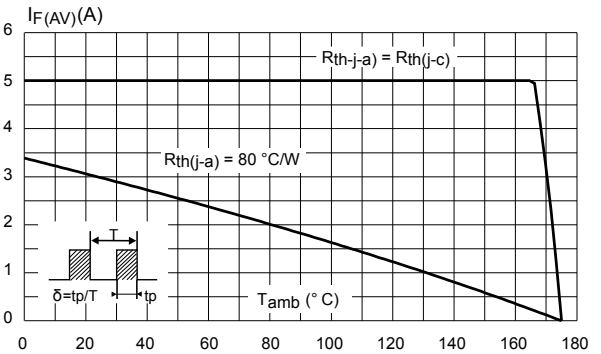

Figure 3. Normalized avalanche power derating versus junction temperature ($T_j = 125$ °C)

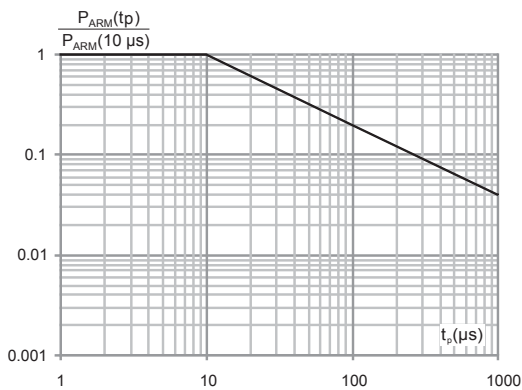

Figure 4. Relative variation of thermal impedance junction to case versus pulse duration

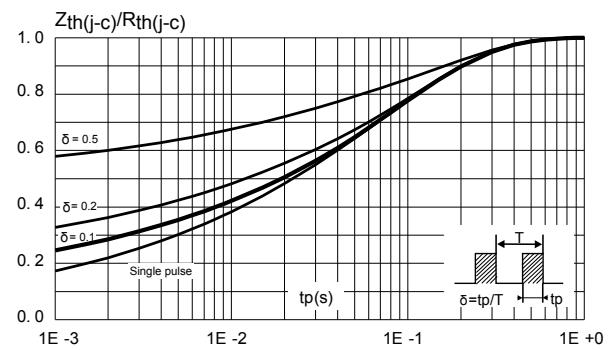

Figure 5. Reverse leakage current versus reverse voltage applied (typical values)

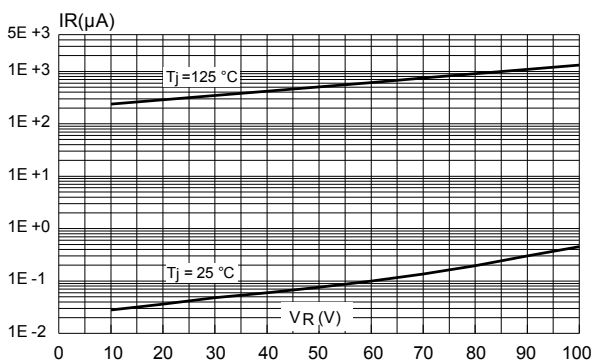

Figure 6. Junction capacitance versus reverse voltage applied (typical values)

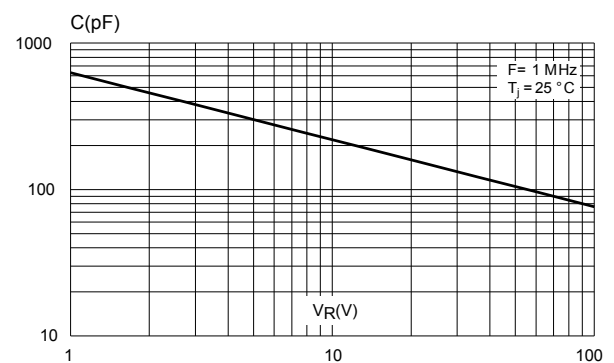

Figure 7. Forward voltage drop versus forward current (maximum values)

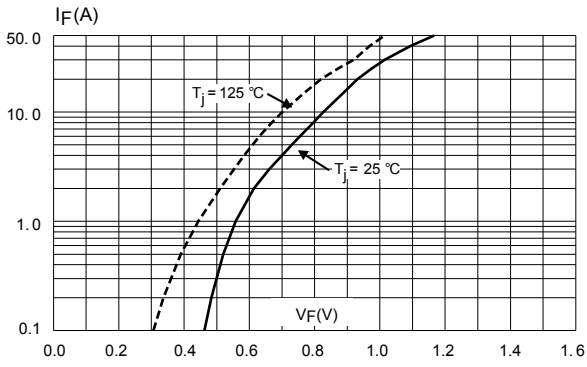
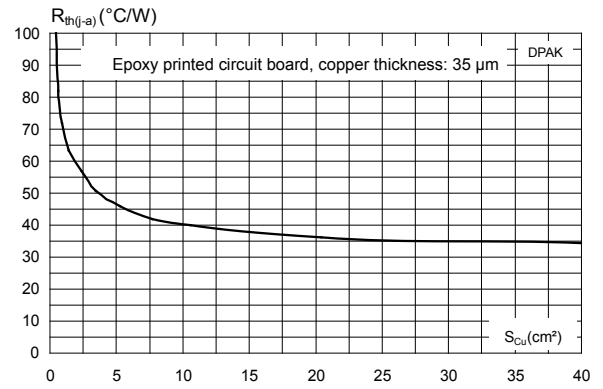

Figure 8. Thermal resistance junction to ambient versus copper surface under tab



2 Package information

In order to meet environmental requirements, ST offers these devices in different grades of ECOPACK® packages, depending on their level of environmental compliance. ECOPACK® specifications, grade definitions and product status are available at: www.st.com. ECOPACK® is an ST trademark.

2.1 DPAK package information

- Epoxy meets UL94, V0
- Lead-free packages

Figure 9. DPAK package outline

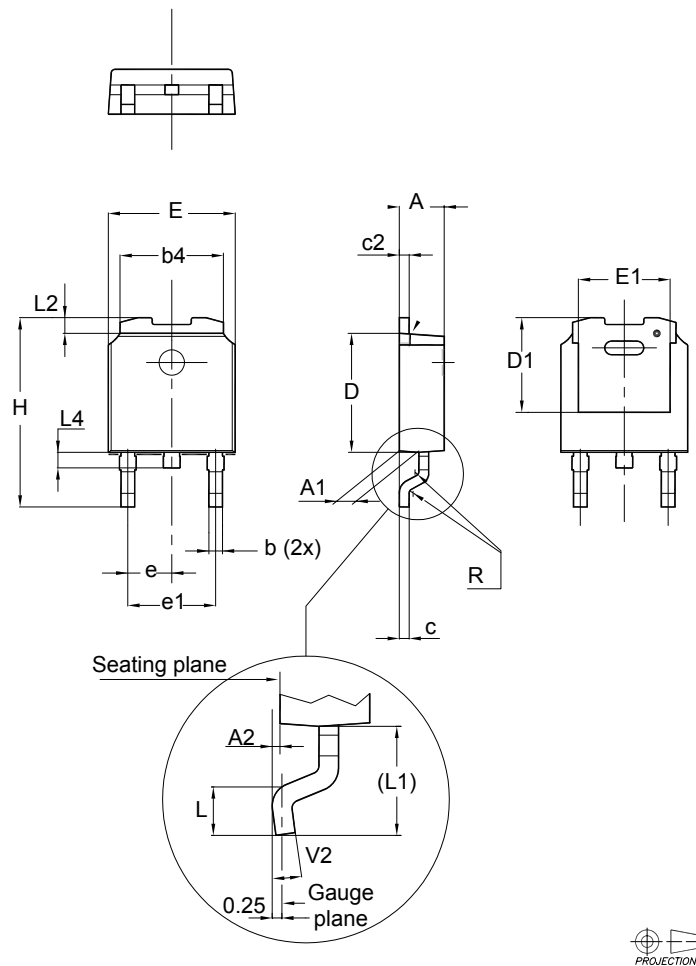
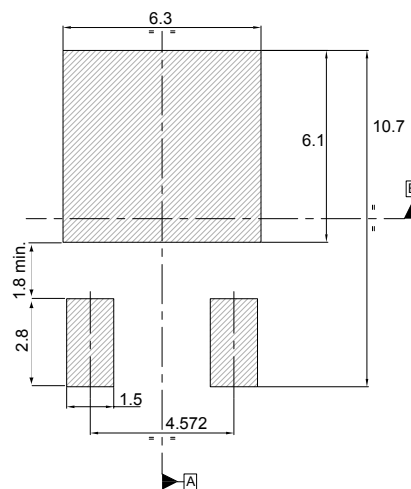

Table 4. DPAK mechanical data

Dim.	Dimensions					
	Millimeters			Inches		
	Min.	Typ.	Max.	Min.	Typ.	Max.
A	2.20		2.40	0.087		0.094
A1	0.90		1.10	0.035		0.043
A2	0.03		0.23	0.001		0.009
b	0.64		0.90	0.025		0.035
b4	5.20		5.40	0.205		0.213
c	0.45		0.60	0.018		0.024
c2	0.48		0.60	0.019		0.024
D	6.00		6.20	0.236		0.244
D1	4.95	5.10	5.25	0.195	0.201	0.207
E	6.40		6.60	0.252		0.260
E1	4.60	4.70	4.80	0.181	0.185	0.189
e	2.16	2.28	2.40	0.085	0.090	0.094
e1	4.40		4.60	0.173		0.181
H	9.35		10.10	0.368		0.398
L	1.00		1.50	0.039		0.059
(L1)	2.60	2.80	3.00	0.102	0.110	0.118
L2	0.65	0.80	0.95	0.026	0.031	0.037
L4	0.60		1.00	0.024		0.039
R		0.20			0.008	
V2	0°		8°	0°		8°

Figure 10. DPAK recommended footprint (dimensions are in mm)



The device must be positioned within $\Phi 0.05 \text{ A B}$

3 Ordering information

Table 5. Ordering information

Order code	Marking	Package	Weight	Base qty	Delivery mode
STPS5H100BY-TR	S5H100Y	DPAK	0.30 g	2500	Tape and reel

Revision history

Table 6. Document revision history

Date	Version	Changes
07-Nov-2011	1	Initial release.
06-Apr-2018	2	Removed figure 4 and figure 5. Updated Section • Features and Section • Description . Updated Figure 3 . Normalized avalanche power derating versus junction temperature ($T_j = 125\text{ °C}$) and Table 1 . Absolute ratings (limiting values at 25 °C, unless otherwise specified). Minor text changes to improve readability.

IMPORTANT NOTICE – PLEASE READ CAREFULLY

STMicroelectronics NV and its subsidiaries (“ST”) reserve the right to make changes, corrections, enhancements, modifications, and improvements to ST products and/or to this document at any time without notice. Purchasers should obtain the latest relevant information on ST products before placing orders. ST products are sold pursuant to ST’s terms and conditions of sale in place at the time of order acknowledgement.

Purchasers are solely responsible for the choice, selection, and use of ST products and ST assumes no liability for application assistance or the design of Purchasers’ products.

No license, express or implied, to any intellectual property right is granted by ST herein.

Resale of ST products with provisions different from the information set forth herein shall void any warranty granted by ST for such product.

ST and the ST logo are trademarks of ST. All other product or service names are the property of their respective owners.

Information in this document supersedes and replaces information previously supplied in any prior versions of this document.

© 2018 STMicroelectronics – All rights reserved