

Dimension:

Pos.	Dimension: A
04	7.70
06	10.20
08	12.70
10	15.20
12	17.70
14	20.20
16	22.70
18	25.20

Specifications:

Current Rating:6.5A AC/DC
 Voltage Rating:250V AC/DC
 Contact Resistance:10m ohm. Max.
 Insulation Resistance:1000M ohm. Min.
 Withstanding Voltage:1500V DC For One Minute
 Operating Temperature Range:-40°C To +105°C

Material and Finish

Insulator:PA4T (UL94V-0)
 Insulator Color:White&Black

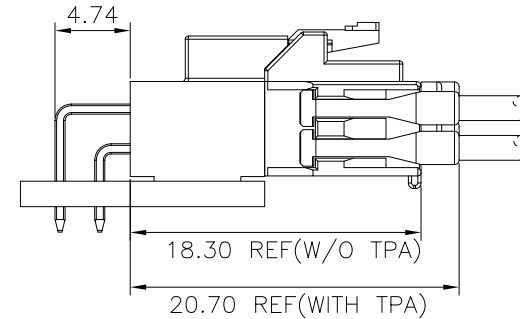
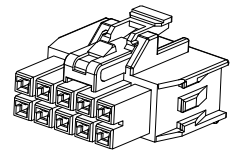

RoHS Compliant

REV	DATE	FILE	BY
	17-Nov-2020		

DRAWN:	GENERAL TOLERANCE: .X=±0.20 .XX=±0.15
CHECKED:	UNIT: MM SCALE:1:1
APPROVAL:	SHEET: 1 / 2 PROJECTION:

CnC Tech Industrial Cable and Connector Technology	
DESCRIPTION: 2.5mm Power Housing Double Rows	SIZE A4
PART NO: 54025-XX	

1

2

3

4

5

A

B

C

D

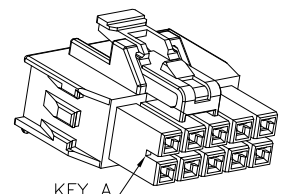

KEY A

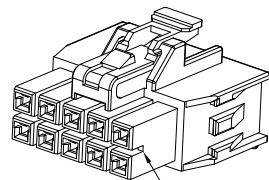

KEY B

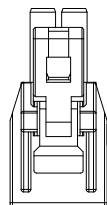

4P

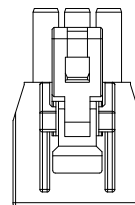

6P

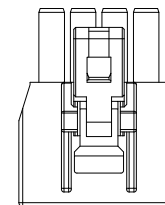

8P

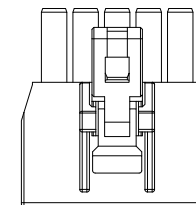

10P

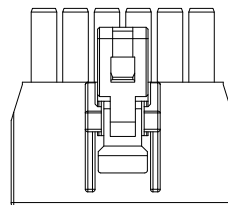

12P

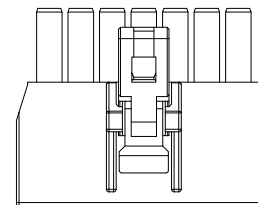

14P

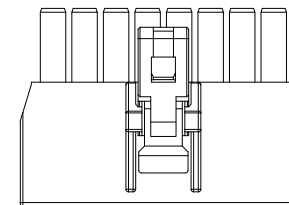

16P

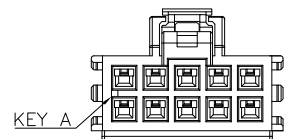

KEY A

BLACK

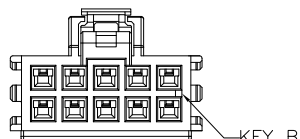

KEY B

WHITE

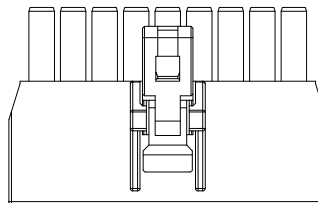

18P

RoHS Compliant

				DRAWN:	GENERAL TOLERANCE: .X=±0.20 .XX=±0.15	<h1 style="color: red; text-align: center;">CnC Tech</h1> <p style="text-align: center;">Industrial Cable and Connector Technology</p>		
				CHECKED:	UNIT: MM SCALE: 1:1			DESCRIPTION: 2.5mm Power Housing Double Rows
				APPROVAL:	SHEET: 2 / 2	PART NO:		
REV	DATE	FILE	BY		PROJECTION:	54025-XX		