7-inch DIY Touch Screen

www.sunfounder.com

Sep 21, 2022

CONTENTS

1	COMPONENTS LIST	3
2	INSTALL THE RASPBERRY PI OS	5
3	ASSEMBLY INSTRUCTIONS	11
4	QUICK USER GUIDE	15
4.1	Adjust the Resolution	15
4.2	Install Virtual Keyboard on Raspberry Pi	18
4.3	Right Click on Raspberry Pi	23
4.4	Rotate the Display and Touch Angle	24
5	PROJECTS AND ACTIVITIES	29
5.1	Multimedia Options	29
5.2	Retro Games Console	32
5.3	3D Printer Monitor	39
5.4	Home Assistant	49
5.5	IoT	74
5.6	GPIO Programming	106
5.7	Scratch Projects	107
5.8	Install Other Systems on Raspberry Pi	198
6	CONNECT THE SCREEN TO THE PC	199
7	APPENDIX	201
7.1	Assemble the Camera Module	201
7.2	GPIO Extension Board	203
7.3	Obtain the IP Address of the Raspberry Pi	205
7.4	Use the SSH Remote Control	206
8	PARAMETERS	211
8.1	General Information	212
8.2	Absolute Maximum Ratings	213
8.3	CTP Characteristics	214
8.4	Interface Description	214
8.5	HDMI Interface Description	215
8.6	Reliability Conditions	217
9	FAQ	219
10	Copyright Notice	221



7-inch touch screen supports Raspbian/Win7/Win8/Win10(Plug and play), Android/Linux (need to be configured first). Equipped with Micro USB and HDMI port support, the screen can be connected to the device via HDMI interface and be powered via USB. Achieving touch function powered by USB doesn't need power cord or drive-free.

About the display language

In addition to English, we are working on other languages for this course. Please contact service@sunfounder.com if you are interested in helping, and we will give you a free product in return. In the meantime, we recommend using Google Translate to convert English to the language you want to see.

The steps are as follows.

- In this course page, right-click and select **Translate to xx**. If the current language is not what you want, you can change it later.

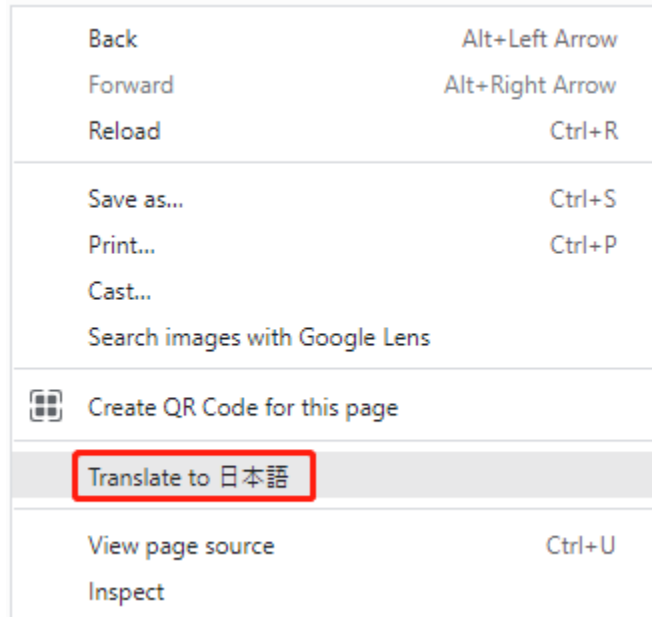

- There will be a language popup in the upper right corner. Click on the menu button to **choose another language**.

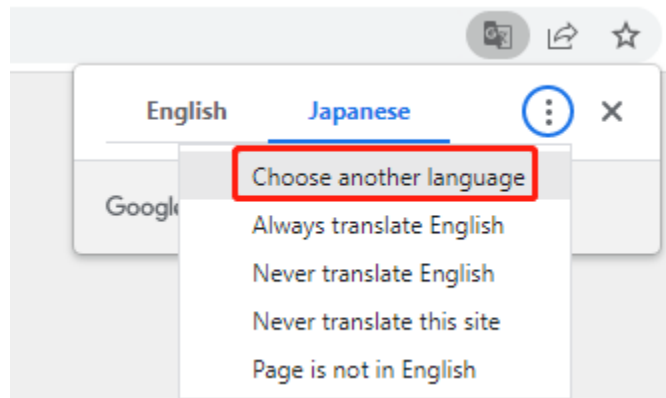

- Select the language from the inverted triangle box, and then click **Done**.

Arabic
Armenian
Azerbaijani
Bangla
Basque
Belarusian
Bosnian
Bulgarian
Burmese
Catalan

2

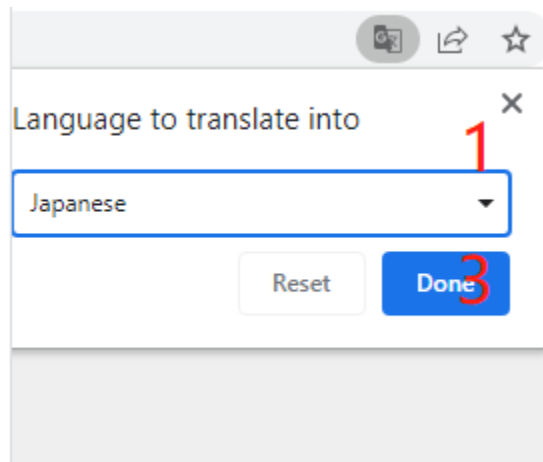

COMPONENTS LIST

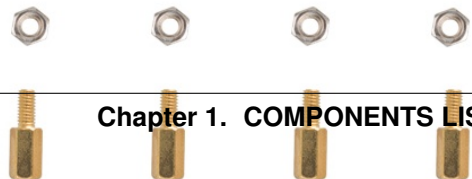

INSTALL THE RASPBERRY PI OS

An operating system needs to be installed onto the Micro SD card before inserting it into the Raspberry Pi.

Note: Skip this chapter if the Raspberry Pi already has an operating system installed.

Raspberry Pi Imager is a quick and easy way to install the Raspberry Pi operating system to a Micro SD card from a computer or laptop.

Browse to the Raspberry Pi Imager site and download the version that matches the computer or laptop's operating system (www.raspberrypi.org/software). When the download is complete, launch the installer program and follow the prompts to install the Raspberry Pi Imager.

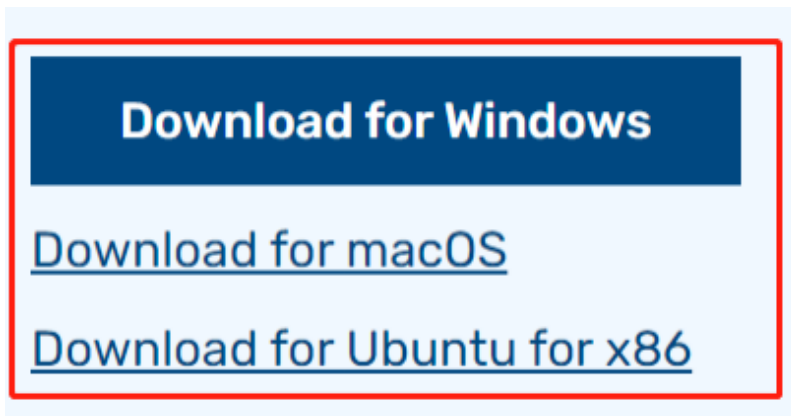

If the Windows operating system prevents the application from launching, click on **More info** and then click on **Run anyway** to install the Raspberry Pi Imager.

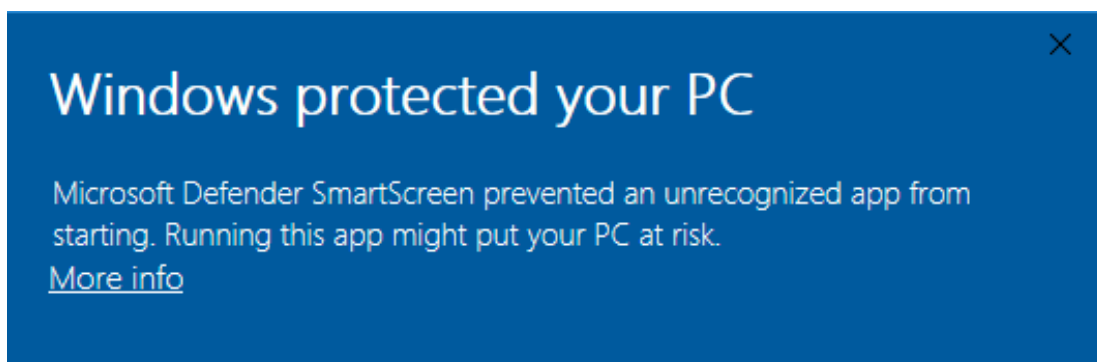

Insert the Micro SD card into the computer or laptop's SD card slot. If the computer or laptop only has a full-size port for SD cards, use a Micro SD card adapter.

Warning: Upgrading the Raspberry Pi OS to **Debian Bullseye** will cause some features to not work, so it is recommended to continue using the **Debian Buster** version.

In the Raspberry Pi Imager, click **CHOOSE OS** -> **Raspberry Pi OS(other)**.

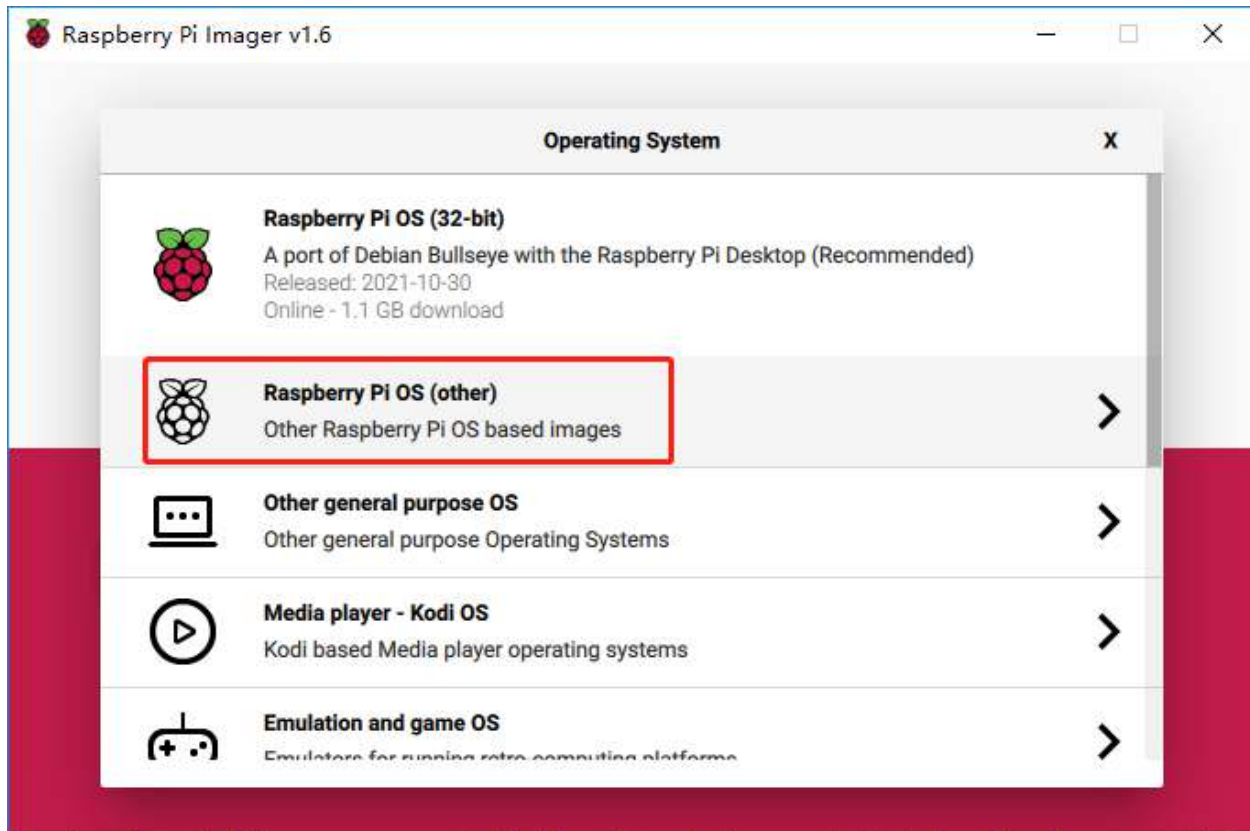

Scroll down to the end of the newly opened page and you will see **Raspberry Pi OS(Legacy)** and **Raspberry Pi OS Lite(Legacy)**, these are security updates for Debian Buster, the difference between them is with or without the desktop. It is recommended to install **Raspberry Pi OS(Legacy)**, the system with the desktop.

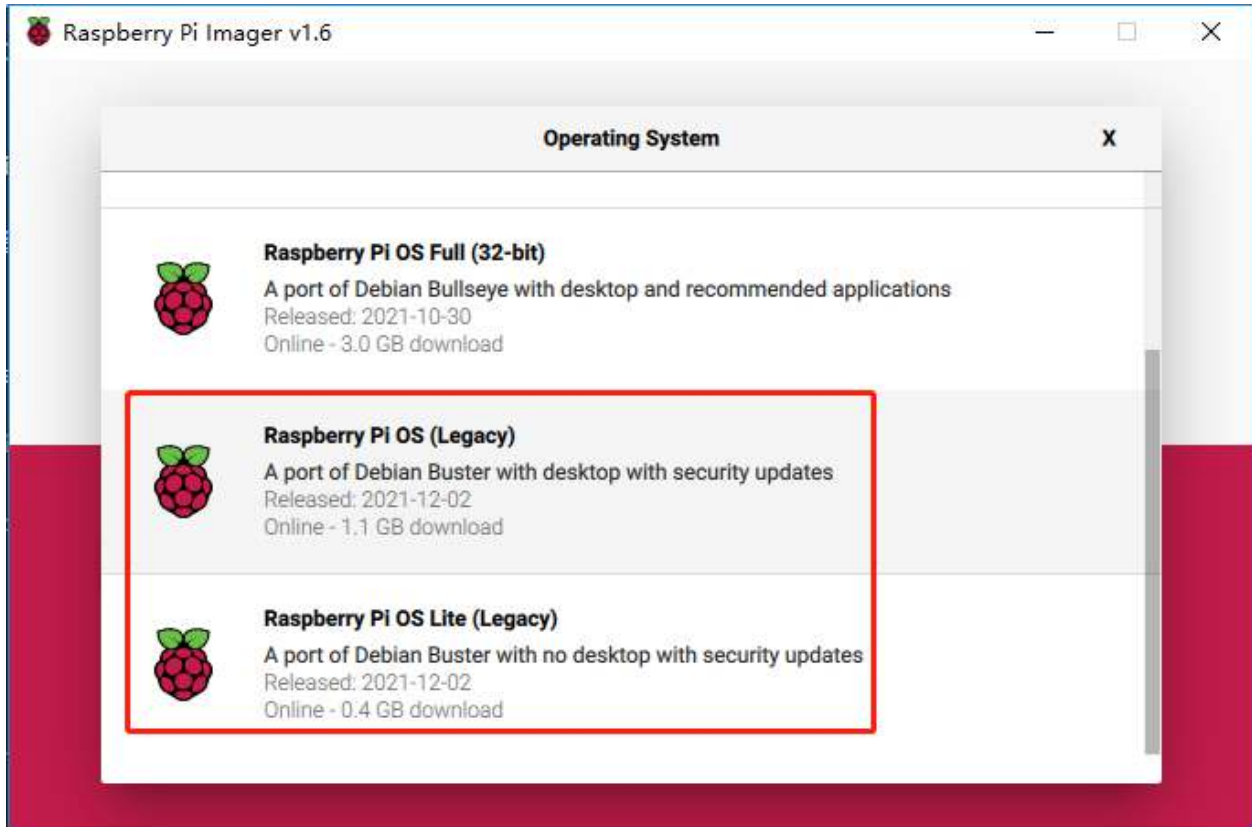

Select the SD card you are using.



Click the **WRITE** button.

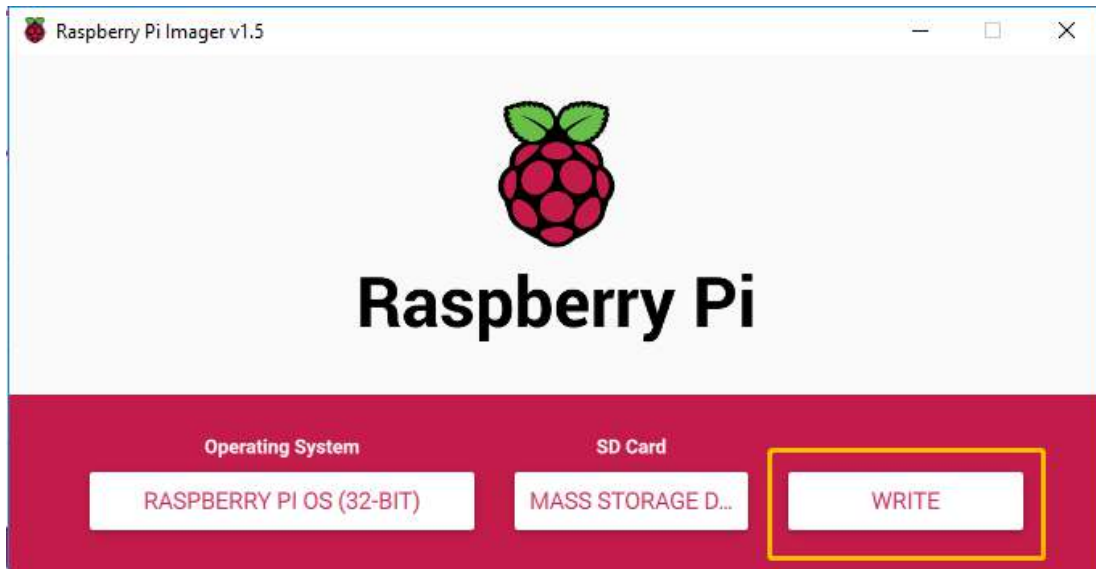

The Imager will overwrite any files already on the SD card. If the SD card has any files, back up these files before clicking Yes.

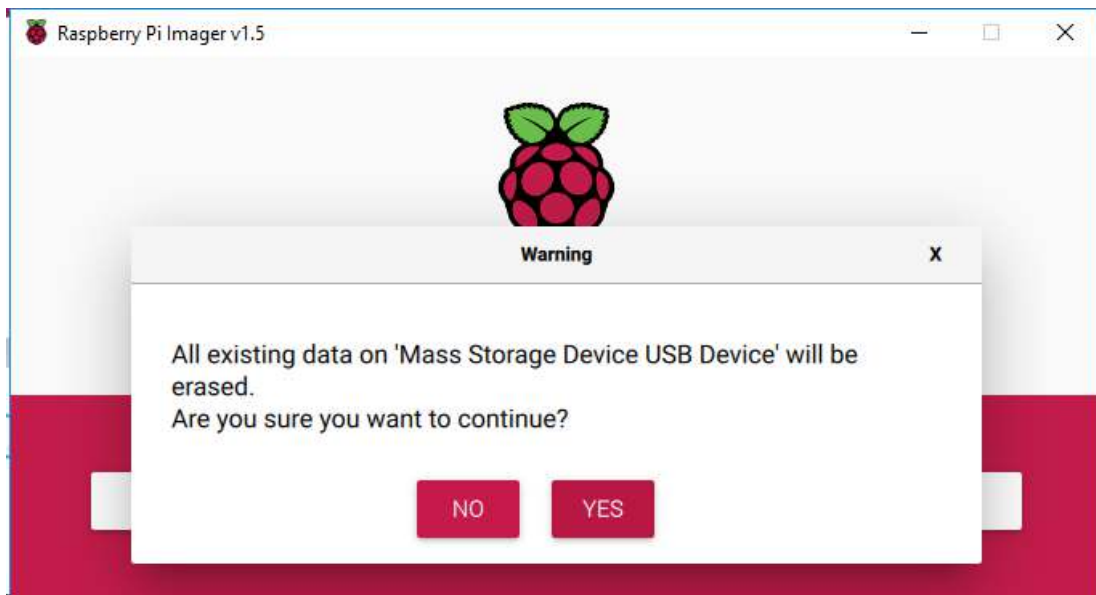

After the Imager completes installing the Operating System on the SD card, click Continue to complete the installation.

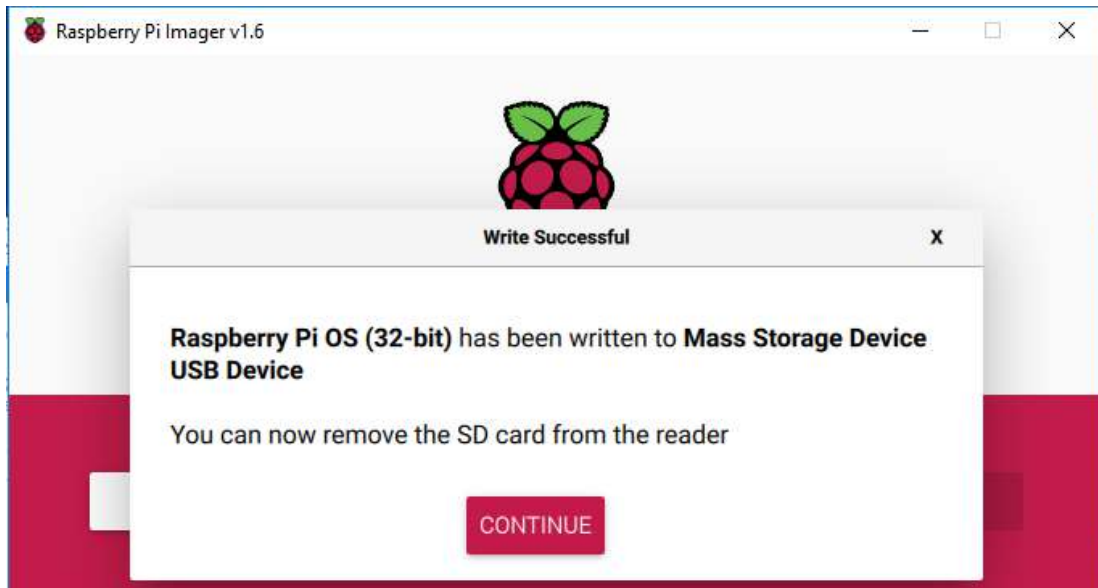

Now insert the Micro SD card with the system installed into the Raspberry Pi.

ASSEMBLY INSTRUCTIONS

Take out M3 nuts and M3x8+6 single-pass brass standoff to support the 7-inch touch screen.



This 7-inch touch screen is compatible with any version of the Raspberry Pi. The kit provides 2 types of HDMI cables, of which HDMI to Micro HDMI cable applies to Raspberry Pi 4 Model B, and the other cable, HDMI to HDMI cable is suitable for Raspberry Pi 3 and the lower versions.



Connect the USB cable to Raspberry Pi.



Plug the USB power supply into a socket and connect it to your Raspberry Pi's power port, and you may find a red LED lighting up on the Raspberry Pi, which indicates that Raspberry Pi is connected to power. As Raspberry Pi starts up (also called booting), raspberries appears in the top left-hand corner on your screen. After a few seconds, the Raspberry Pi Desktop will appear.



QUICK USER GUIDE

4.1 Adjust the Resolution

For the Raspberry Pi 3 and the lower versions, you need reset the resolution ratio as follows. As for Raspberry Pi 4, when you start up it, the resolution is optimum. If you want to change its resolution, please refer to the next part.

For Raspberry Pi 3 or Lower Version

Step 1: Open config.txt.

```
sudo nano /boot/config.txt
```

Step 2: Modify the /boot/config.txt file.

- 1) Define a custom CVT mode (since Raspberry Pi uses the standard rate when 1024x600 is not included, you need to set the aspect ratio close to 16:9) and add the following lines below `#hdmi_force_hotplug=1`.

```
hdmi_cvt=1024 600 60 3 0 0 0
```

`hdmi_cvt=<width> <height> <framerate> <aspect> <margins> <interlace>`

value	Default	Description
width	(required)	width in pixels
height	(required)	height in pixels
framerate	(required)	framerate in Hz
aspect	3	aspect ratio 1=4:3, 2=14:9, 3=16:9, 4=5:4, 5=16:10, 6=15:9
margins	0	0=margins disabled, 1=margins enabled
interlace	0	0=progressive, 1=interlaced
rb	0	0=normal, 1=reduced blanking

- 2) Find the following lines, delete the “#” mark and modify the value like this:

```
hdmi_group=2  
hdmi_mode=87  
....  
hdmi_drive=2
```

hdmi_group=2 means DMT (Display Monitor Timings, the standard typically used on monitors) **hdmi_mode=87** indicates we create a new hdmi mode named 87. **hdmi_drive=2** selects the Normal HDMI mode.

After the modification is done, save and exit. For more details about configuring config.txt, refer to Raspberry Pi official website: <https://www.raspberrypi.org/documentation/configuration/config-txt.md>.

Step 3: Reboot Raspberry Pi.

7-inch DIY Touch Screen

Reboot the Raspberry pi with the command `sudo reboot`.

```
sudo reboot
```

For Raspberry Pi 4

1) Click the **Raspberry Pi icon -> Preferences -> Screen Configuration**.



2) Then choose **Configure -> Screens -> HDMI-1 -> Resolution -> choose the resolution that you want**.

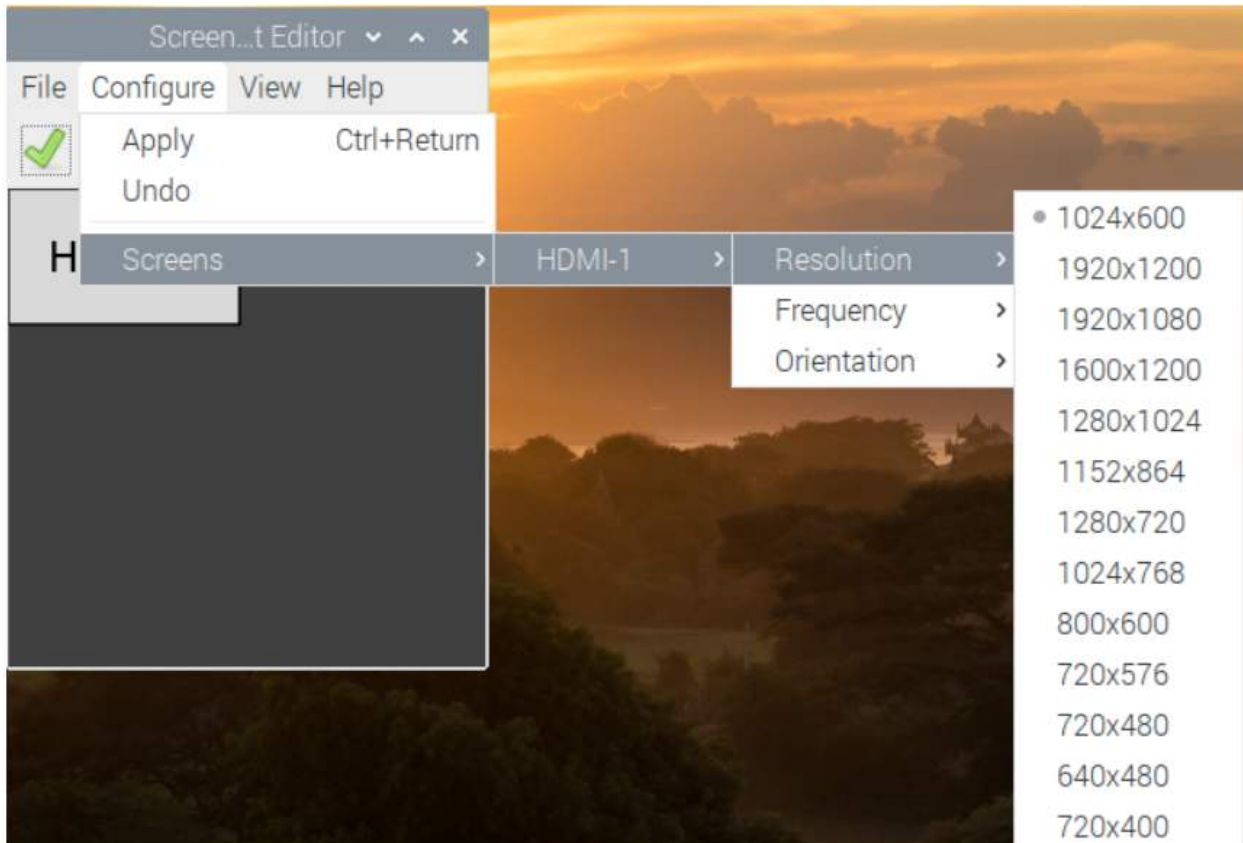

3) After that you need to click the **tick icon** to save your configure.

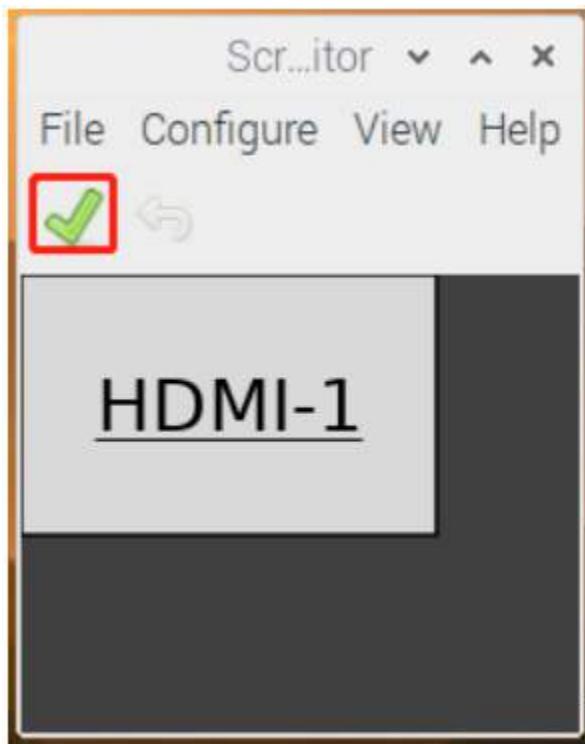

4.2 Install Virtual Keyboard on Raspberry Pi

When you use a touch panel, you can connect an external keyboard to help you do a text input operation, but it is best to install a virtual keyboard.

Install the required software with the following command.

```
sudo apt install onboard  
sudo apt install at-spi2-core
```

In order to make the virtual keyboard have a better effect, you need to do further settings.

Click the Raspberry Pi icon in the upper left corner and select **Preferences -> Onboard Settings**.

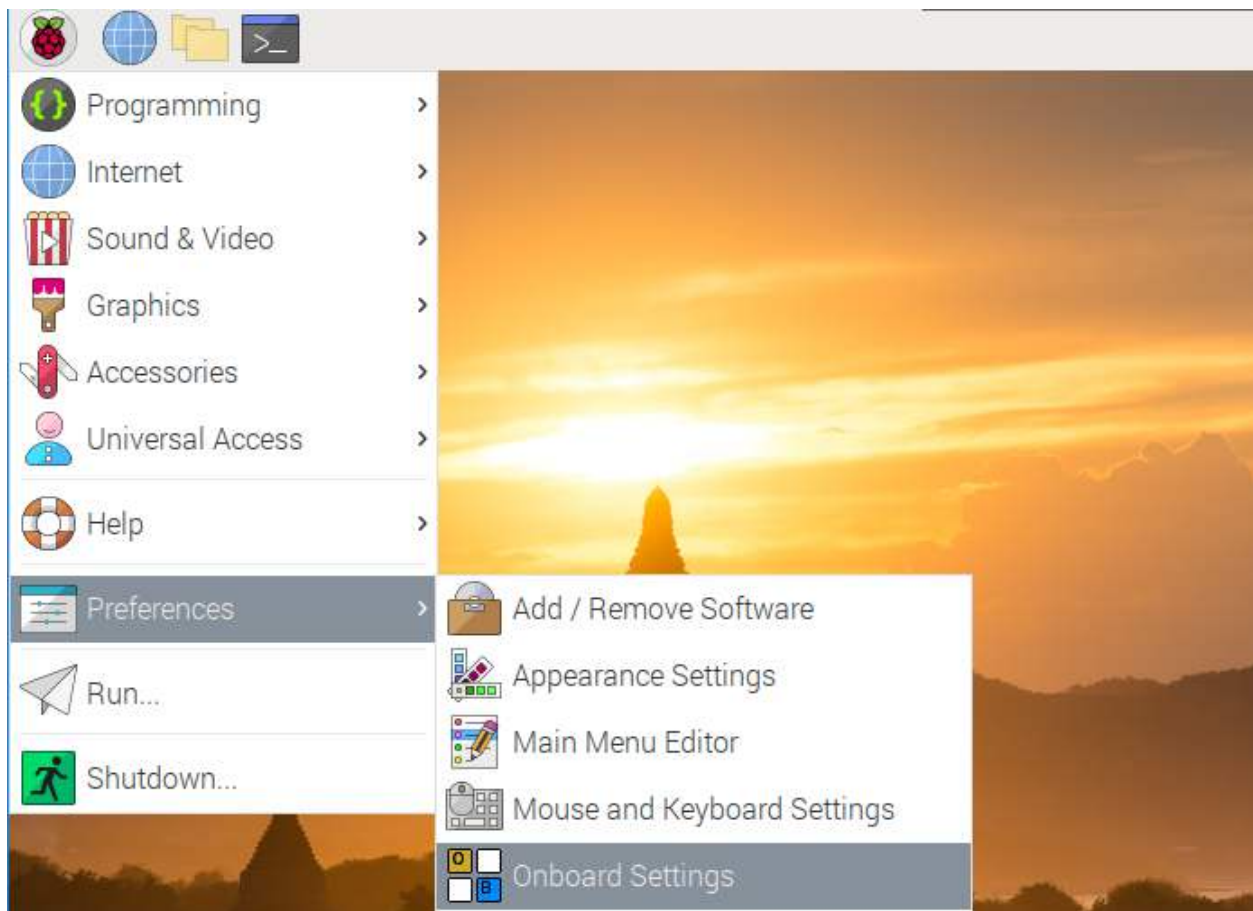

In the **General** option, check the following 2 items. When you check **Automatically display when editing text**, you will be prompted to reboot, you can reboot after all settings are complete.

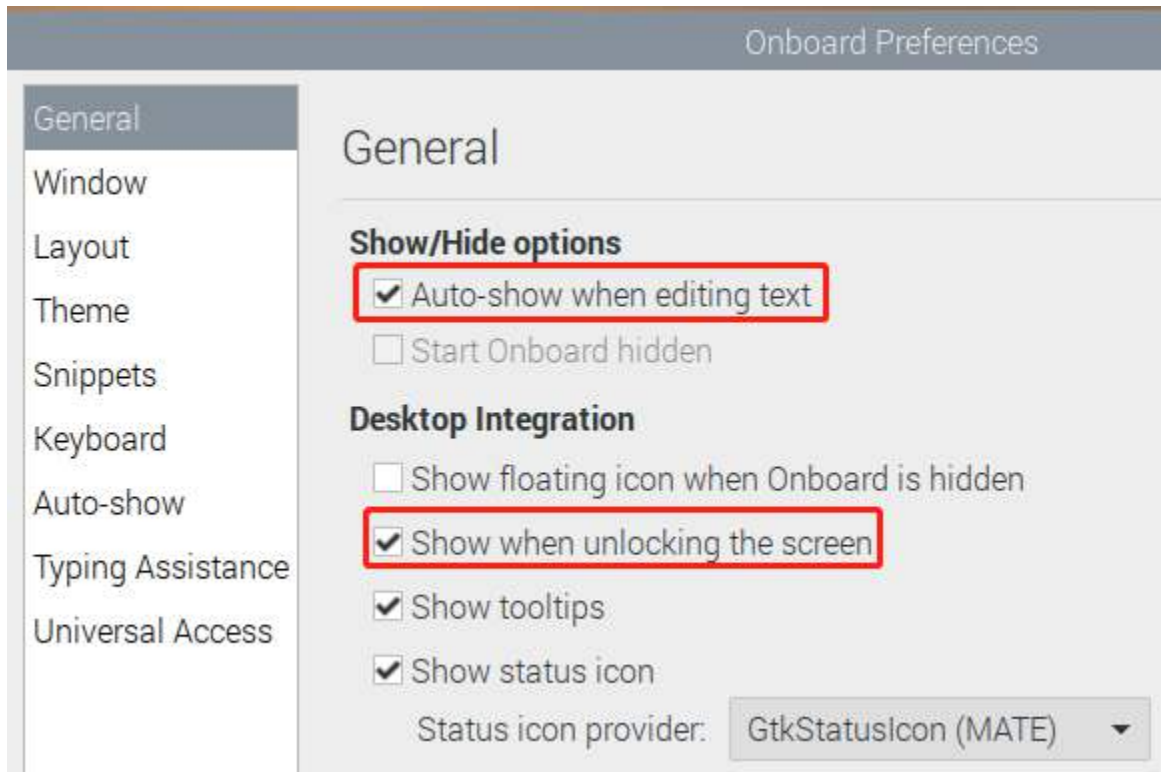

In the **Window** option, check **Dock to screen edge**.

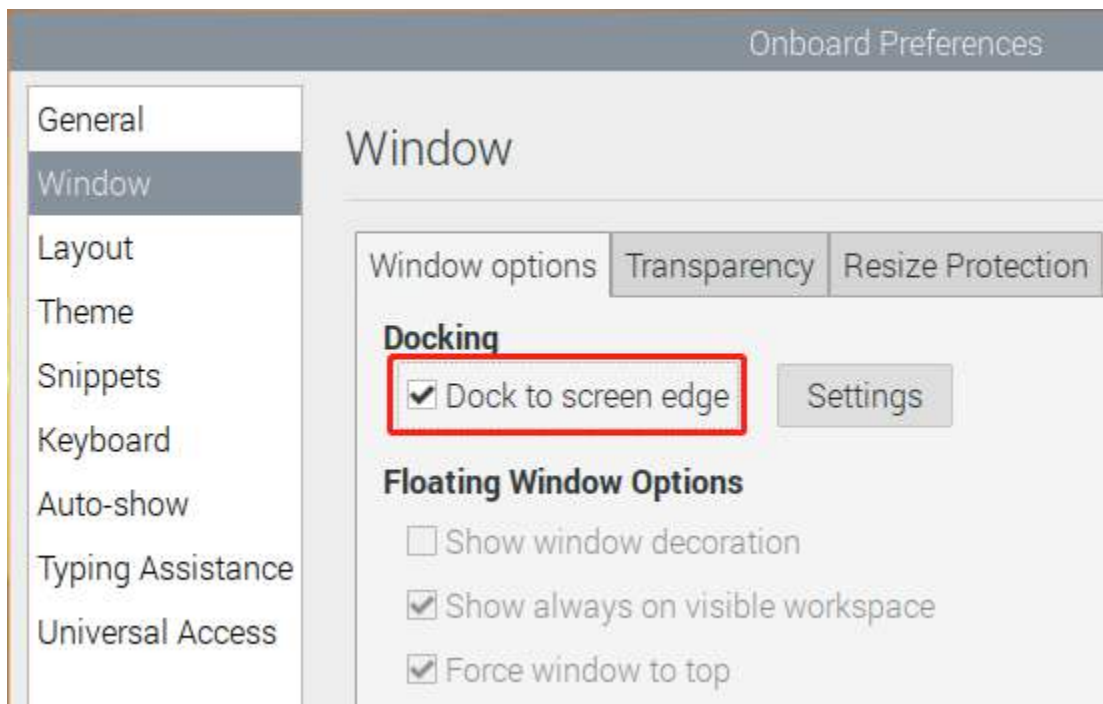

And in **Auto-show** option, check **Auto-show when editing text** again.

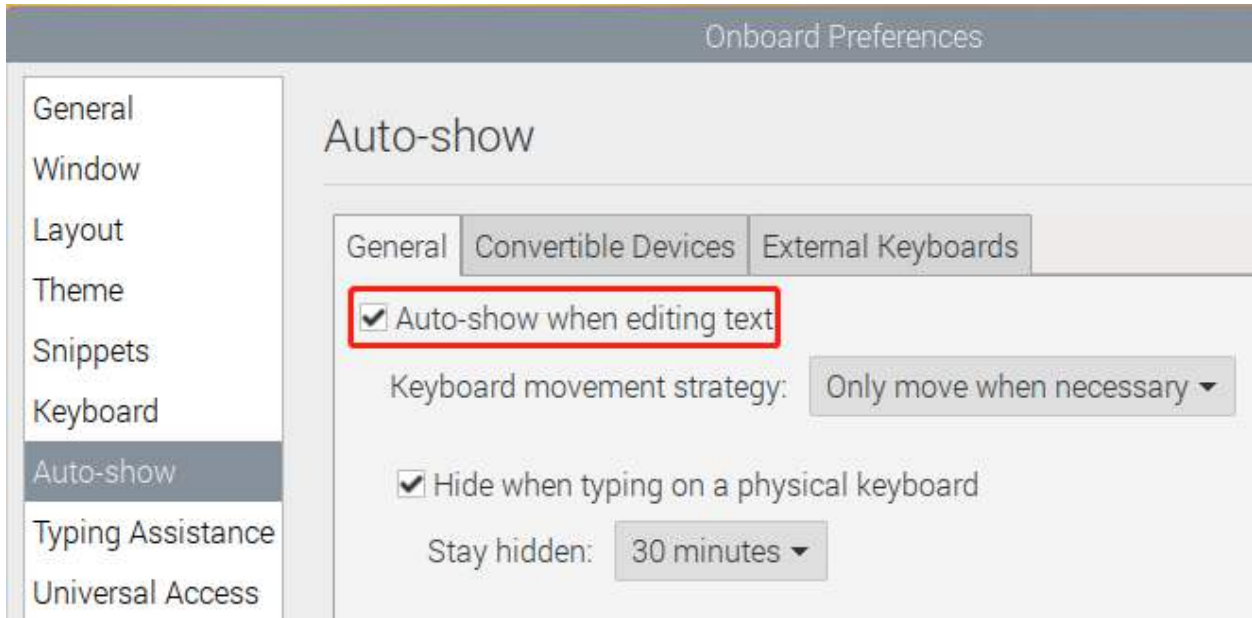

The next 2 items are optional, the ones checked in the picture are recommended by us, you can also check other ones. In **Layout** option, **Small** is recommended.

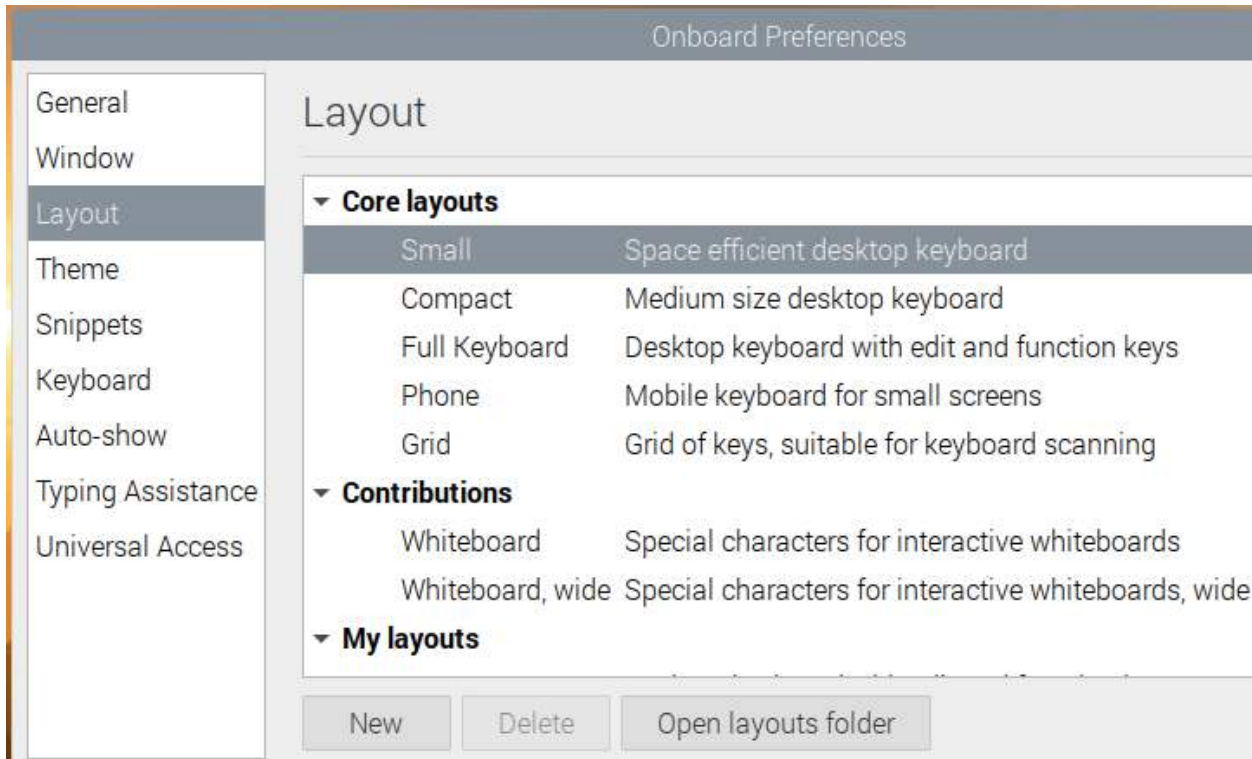

In **Theme** option, **DarkRoom** is recommended.

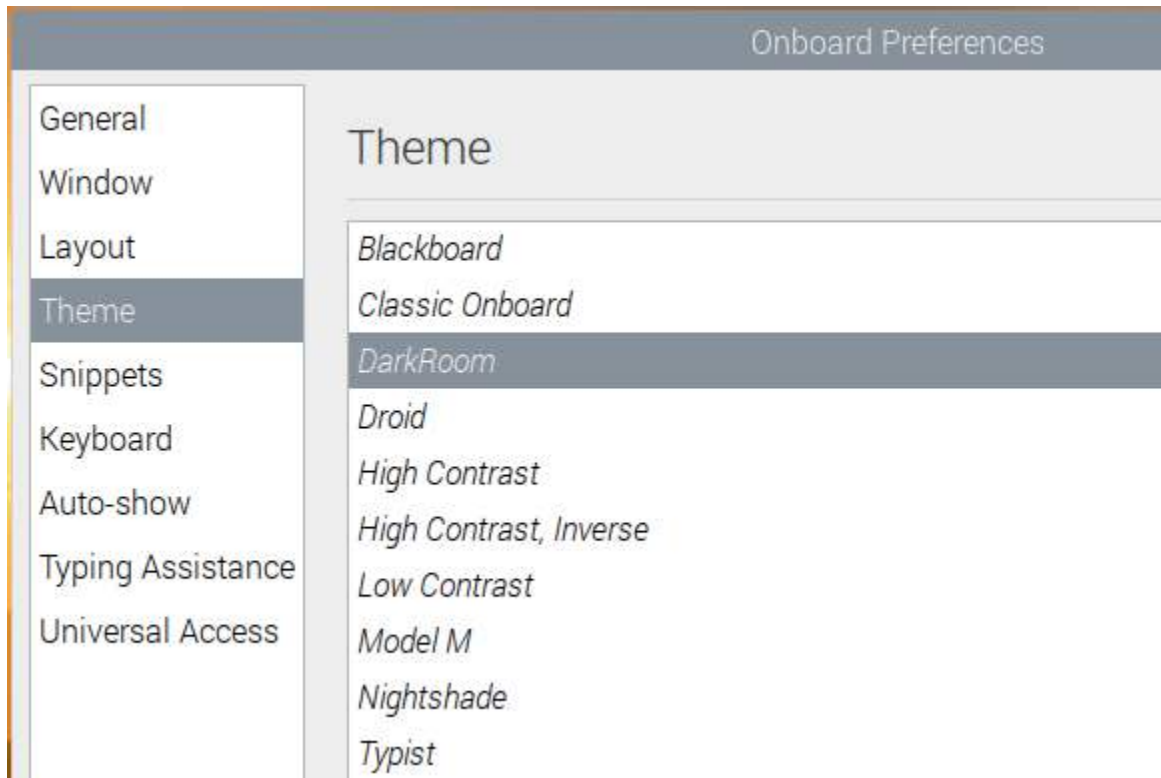

After the setting is complete, restart Raspberry pi. Every time you restart Raspberry pi, you need to click **General Access** -> **Onboard** to enable the virtual keyboard.

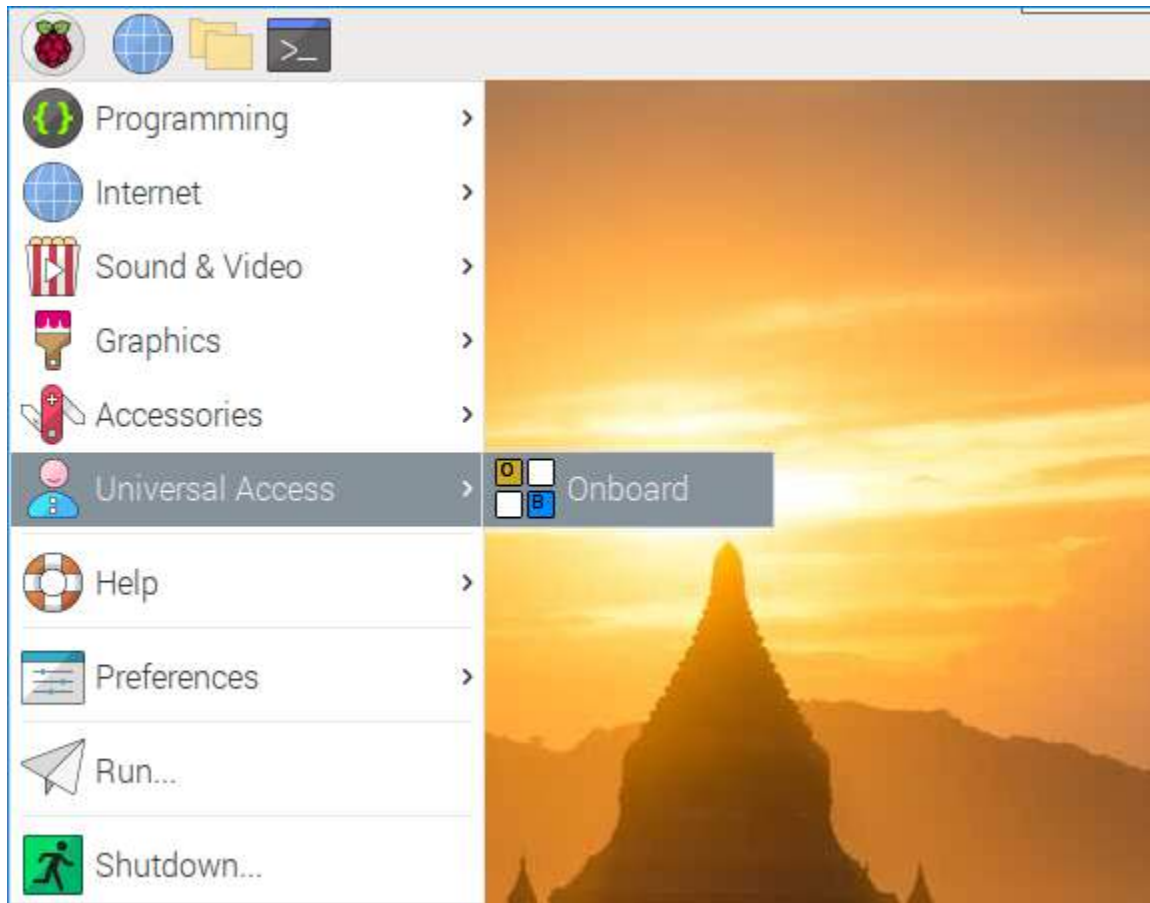

Now you can use this keyboard to edit your files or codes.

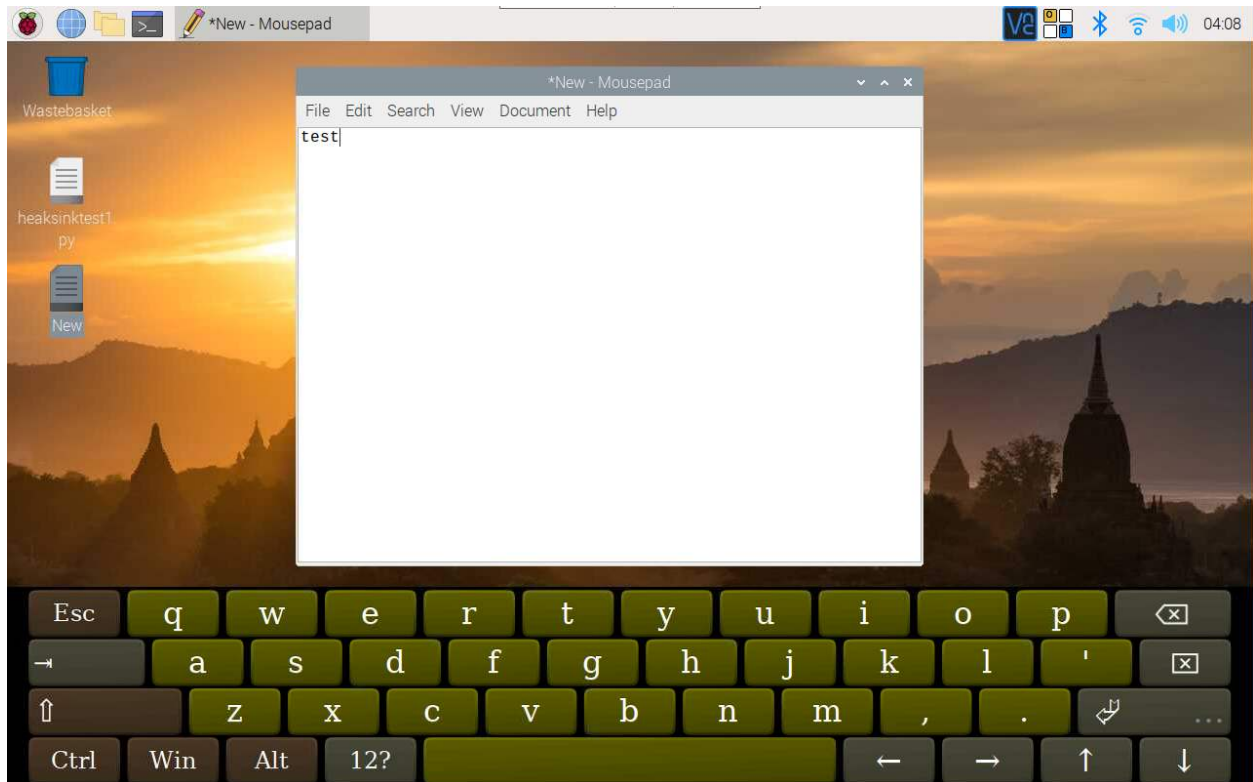

4.3 Right Click on Raspberry Pi

The touchscreen makes it easy to perform simple navigation tasks with your finger or stylus, but you may want to be able to use the context menu (right-click menu).

Then you will need to download a Touchégg. Enter the following command to install it.

For 32-bit OS:

```
wget https://github.com/JoseExposito/touchegg/releases/download/2.0.14/touchegg_2.0.14_armhf.deb
sudo apt install ./touchegg_2.0.14_armhf.deb
```

For 64-bit OS:

```
wget https://github.com/JoseExposito/touchegg/releases/download/2.0.14/touchegg_2.0.14_arm64.deb
sudo apt install ./touchegg_2.0.14_arm64.deb
```

After restarting, you can double-tap the screen to bring up the context menu.

```
sudo reboot
```

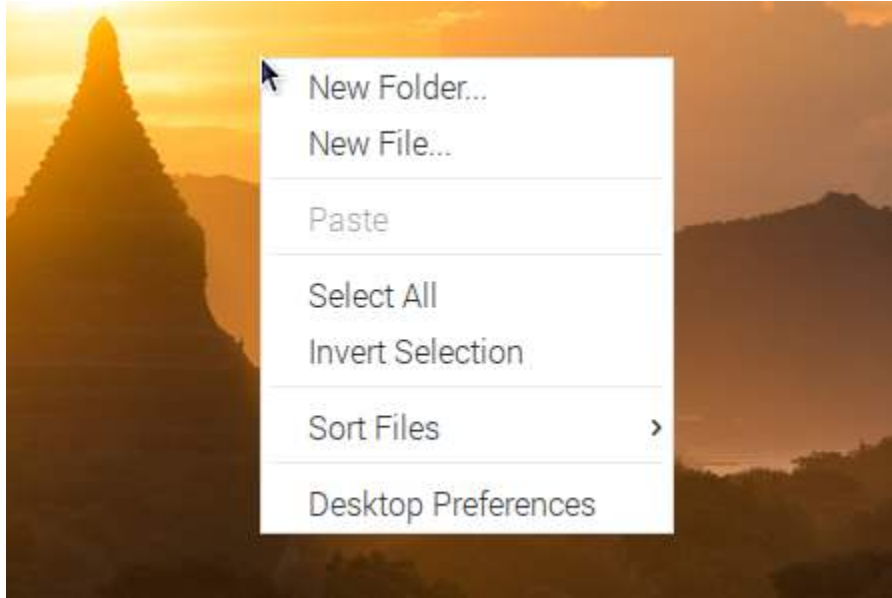

Note: The product is not compatible with some of Touchégg's gestures, such as three-finger zoom in/out.

4.4 Rotate the Display and Touch Angle

After the Raspberry Pi is turned on, if you find that the display or touch angle is not correct, or you need to rotate to other angles during use, you can follow the tutorial below to achieve them.

4.4.1 Rotate the Display Angle

There are two ways to rotate the display angle, one way is from the Raspberry Pi desktop, and the other way is using the command line.

1. Set from the Raspberry Pi Desktop

Click the **Raspberry Pi icon** -> **Preferences** -> **Screen Configuration**.

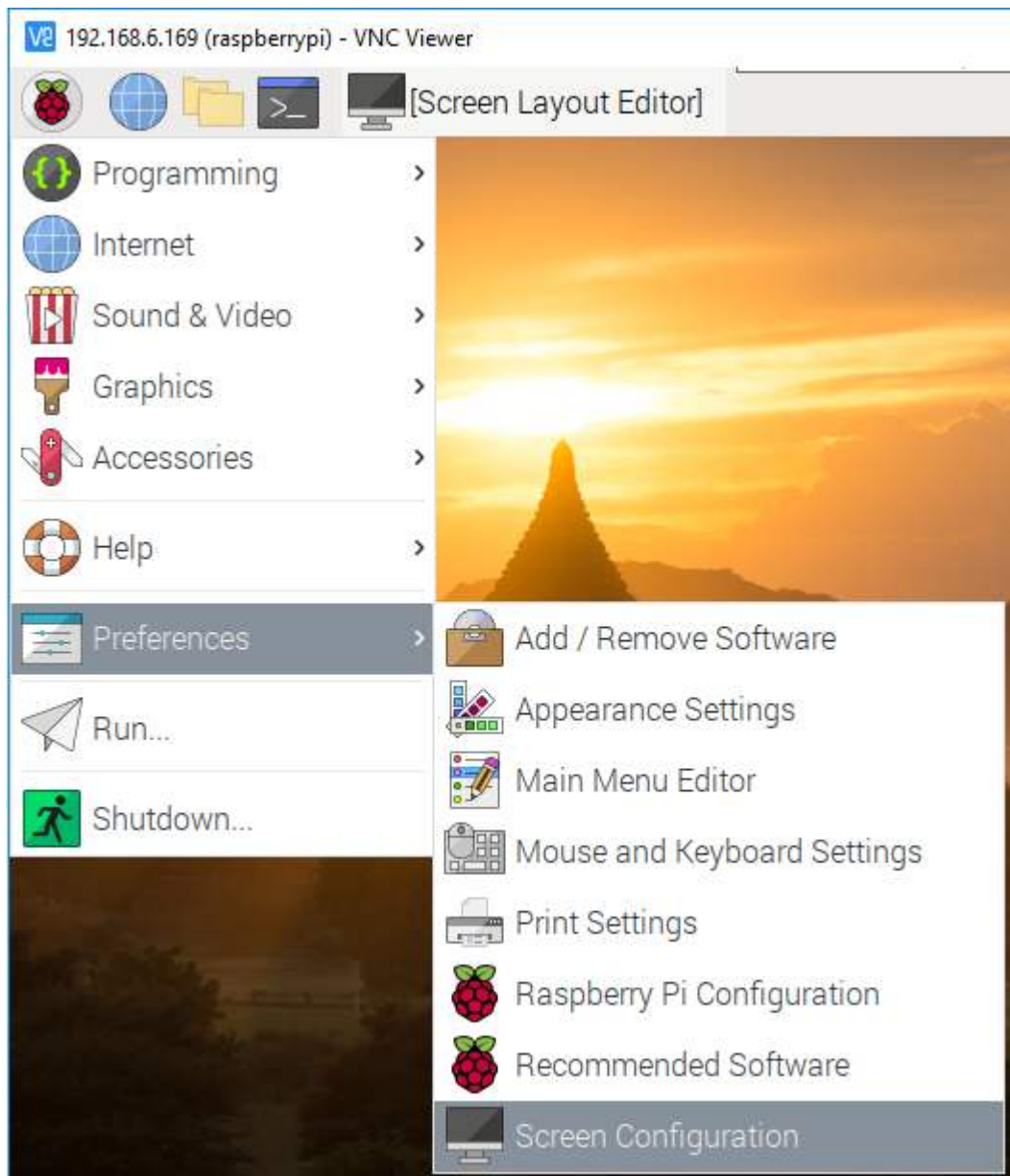

Then click **Configure** -> **Screens** -> **HDMI-1** -> **Orientation**, then select the angle you want to rotate.

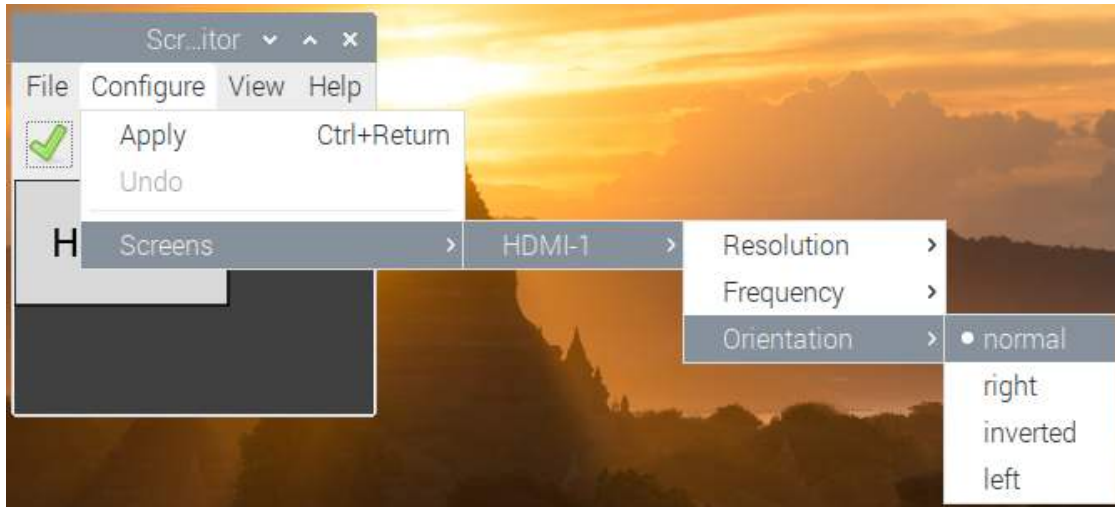

Click the green checkbox to take effect.

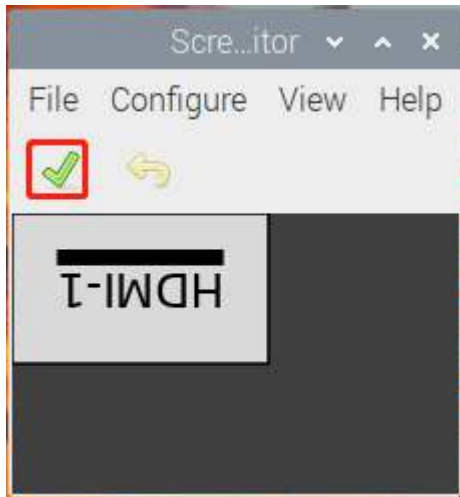

Note:

- After checking the box, you need to confirm the changes by clicking **OK** within 10 seconds, otherwise it will go back to the previous angle.

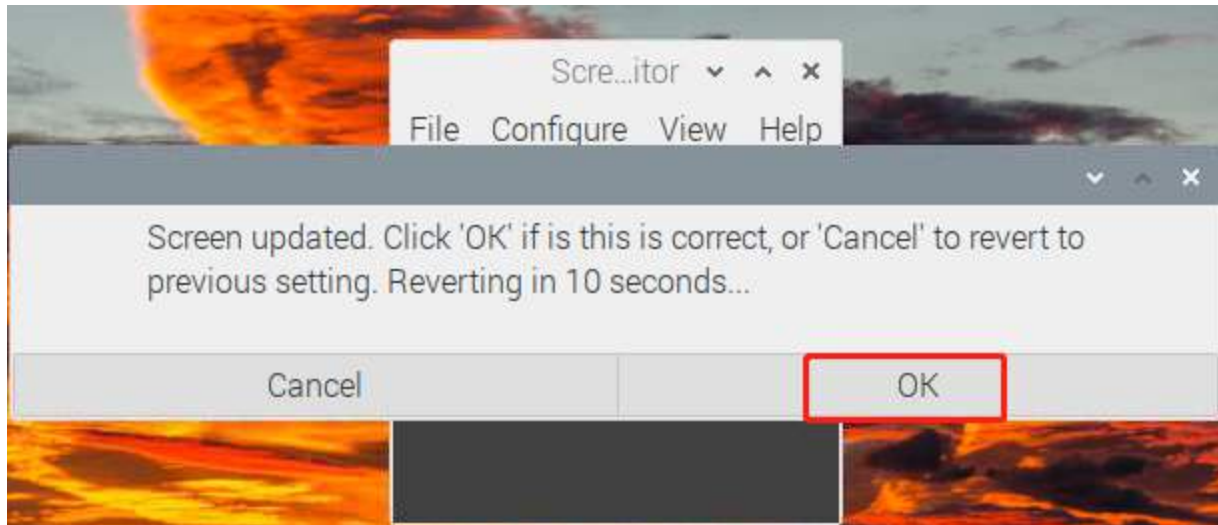

- For Debian Bullseye system, there is only one option - **Inverted**, if you want to rotate to another angle, you need to set it from command line.

2. Using the Command Line

To make this change stay after a reboot, do the following to rotate your display.

Open the `autostart` file.

```
sudo nano /etc/xdg/lxsession/LXDE-pi/autostart
```

Add the following line to the end.

```
@xrandr --output HDMI-1 --rotate right
```

- `right` represents the direction of rotation, and there are 4 directions to choose from: `normal`, `right`, `left` and `inverted`.

After restarting the Raspberry Pi, you will see the effect of rotation.

```
sudo reboot
```

4.4.2 Rotate Touch Angle

Run the following command to open the `40-libinput.conf` file.

```
sudo nano /usr/share/X11/xorg.conf.d/40-libinput.conf
```

Find the touchscreen section and add the corresponding rotation angle to it.

```
File Edit Tabs Help
GNU nano 5.4 /usr/share/X11/xorg.conf.d/40-libinput

Section "InputClass"
    Identifier "libinput touchscreen catchall"
    MatchIsTouchscreen "on"
    MatchDevicePath "/dev/input/event*"
    Driver "libinput"
    Option "CalibrationMatrix" "-1 0 1 0 -1 1 0 0 1"
EndSection

Section "InputClass"
    Identifier "libinput tablet catchall"
    MatchIsTablet "on"
    MatchDevicePath "/dev/input/event*"
    Driver "libinput"
EndSection

^G Help      ^O Write Out ^W Where Is  ^K Cut      ^T Exc
^X Exit      ^R Read File ^\ Replace   ^U Paste    ^J Jus
```

- 0 degrees: Option "CalibrationMatrix" "1 0 0 0 1 0 0 0 1"
- 90 degrees: Option "CalibrationMatrix" "0 1 0 -1 0 1 0 0 1"
- 180 degrees: Option "CalibrationMatrix" "-1 0 1 0 -1 1 0 0 1"
- 270 degrees: Option "CalibrationMatrix" "0 -1 1 1 0 0 0 0 1"

Note: For some Raspberry Pis, you may set the rotation angle of touch to 90°, but eventually you find that it is not 90° and you need to manually alternate these 4 sets of values.

After restarting the Raspberry Pi, you will see the effect of rotation.

```
sudo reboot
```

PROJECTS AND ACTIVITIES

To get started using this screen, this chapter includes some interesting and challenging projects to choose from.

5.1 Multimedia Options

Watch videos, read e-books, or play games on this screen.

5.1.1 Watch Video

The Raspberry Pi has a built-in video player: VLC Video Player.



Watch a local video directly by double-clicking on the VLC Video Player icon, or log in to the YouTube website from Google Chrome browser to watch videos.



5.1.2 Read E-book

Read online from the Google Chrome browser.



5.1.3 Play Game

Click **Preferences** -> **Recommended Software** -> **Games** to install games on this screen.

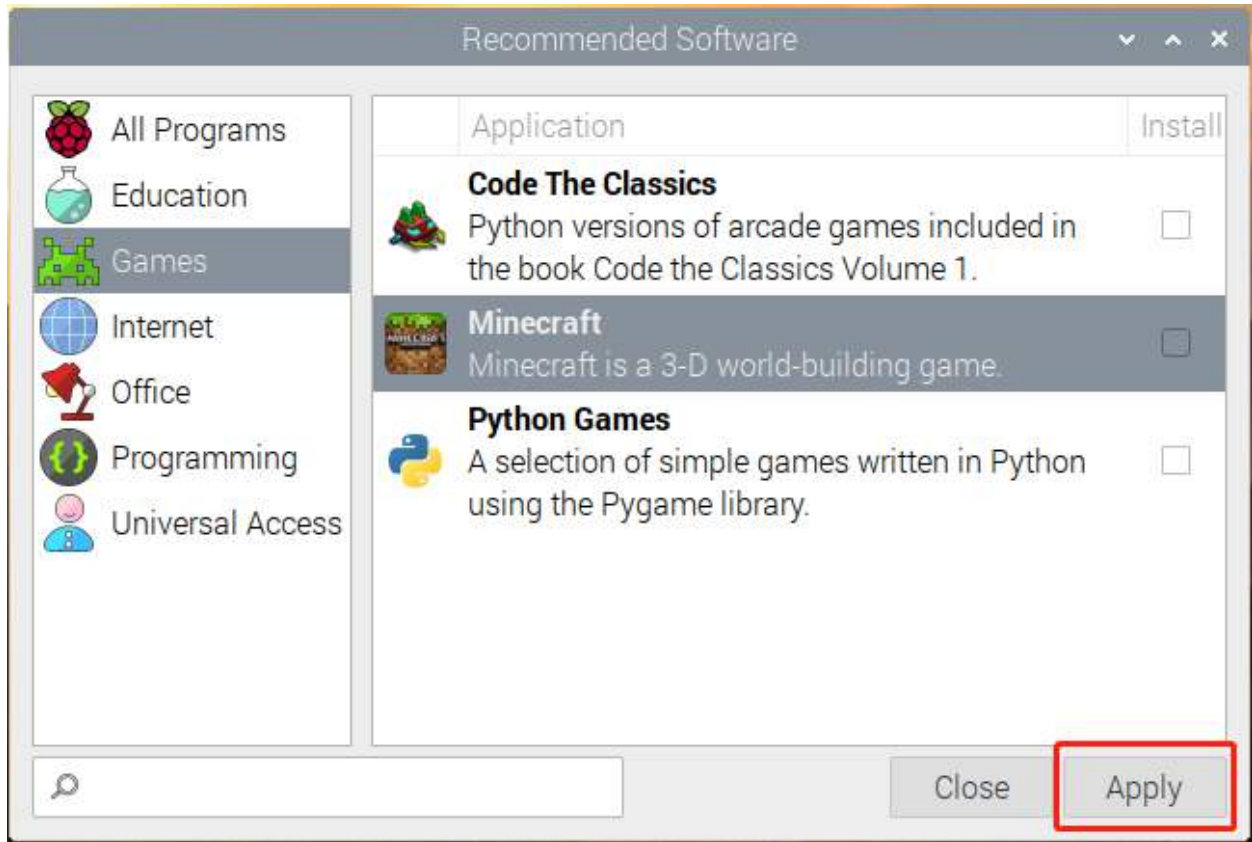

For example, install **Minecraft**, and plug in a keyboard and mouse to play.

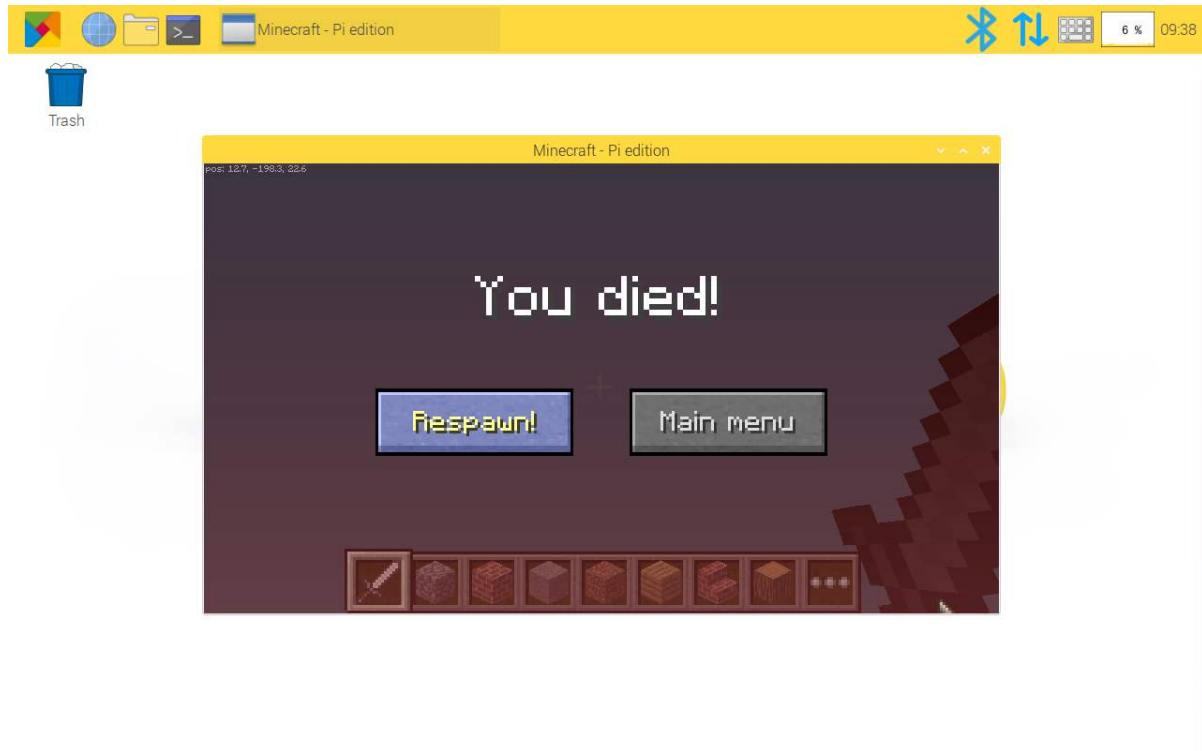

5.2 Retro Games Console

5.2.1 Description

You can turn this screen Raspberry Pi into a retro games console playing with your friends, let's see how we can do it!



5.2.2 Required Components

- A Screen
- 8G+ MicroSD Card
- Micro-SD Card Reader
- Keyboard
- Gamepad

It is recommended to use a Raspberry Pi 4 as the main control board, with Retro Pie as the Operating System.

That Raspberry Pi uploads or downloads the game system and game ROM needs taking up a large memory, so it is recommended to use a large-capacity SD card to avoid configuration failures.



When playing games, a gamepad and a keyboard are needed.



This screen is a 1280x800 LCD touch screen, allowing for high resolution and sound quality to provide an excellent gaming experience.



5.2.3 Game System Installation

RetroPie allows you to turn your Raspberry Pi, ODroid C1/C2, or PC into a retro-gaming machine. It builds upon Raspbian OS, Emulation Station, RetroArch and many other projects to enable you to play your favorite Arcade, home-console, and classic PC games with the minimum set-up.

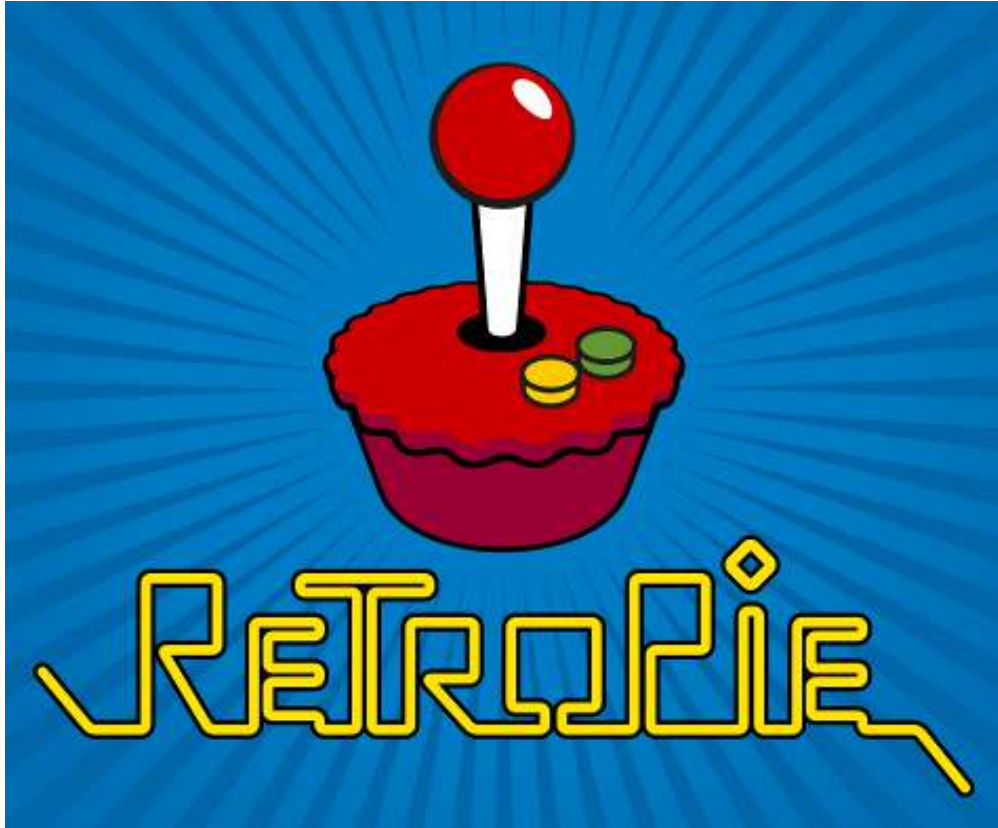

Installing **RetroPie**:

Step 1: Download the SD image compatible with the Raspberry Pi 4 on the [RetroPie official website](#).

Pre-made images for the Raspberry Pi

The latest pre-made image of RetroPie is v4.6 – released April 28, 2020.

Contributions to the project are appreciated, so if you would like to support us with a donation you can do so here.



Contents [\[hide\]](#)

- 1 Pre-made images for the Raspberry Pi
 - 1.1 BerryBoot
- 2 Installing on top of an existing OS
 - 2.1 Raspbian on a Raspberry Pi
 - 2.2 Debian / Ubuntu on a PC
 - 2.3 Ubuntu on an ODroid-C1/C2
 - 2.4 Ubuntu on an ODroid-XU3/XU4
- 3 PetRockBlock Downloads

If you are installing RetroPie for the first time please follow the **OFFICIAL Installation Guide**

Click button to download



Step 2: After the download is complete, unzip the downloaded package containing the image file.

Step 3: Then flash the RetroPie image into the micro-SD card.

- For Windows, use: [Raspberry Pi Imager](#), [Etcher](#), or [Win32DiskImager](#).

Note: Win32DiskImager requires an .img file extracted from the .img.gz image downloaded in step 2. You can use a program like [7zip](#) to do this.

- For macOS, use: [Raspberry Pi Imager](#), [Etcher](#), [Apple Pi Baker](#), or the `dd` command.
- For Linux, use: [Raspberry Pi Imager](#), [Etcher](#), or the `dd` command

Note: MacOS/Linux users can optionally extract the .img image from the downloaded .img.gz by using `gunzip` (macOS users can also simply double-click it).

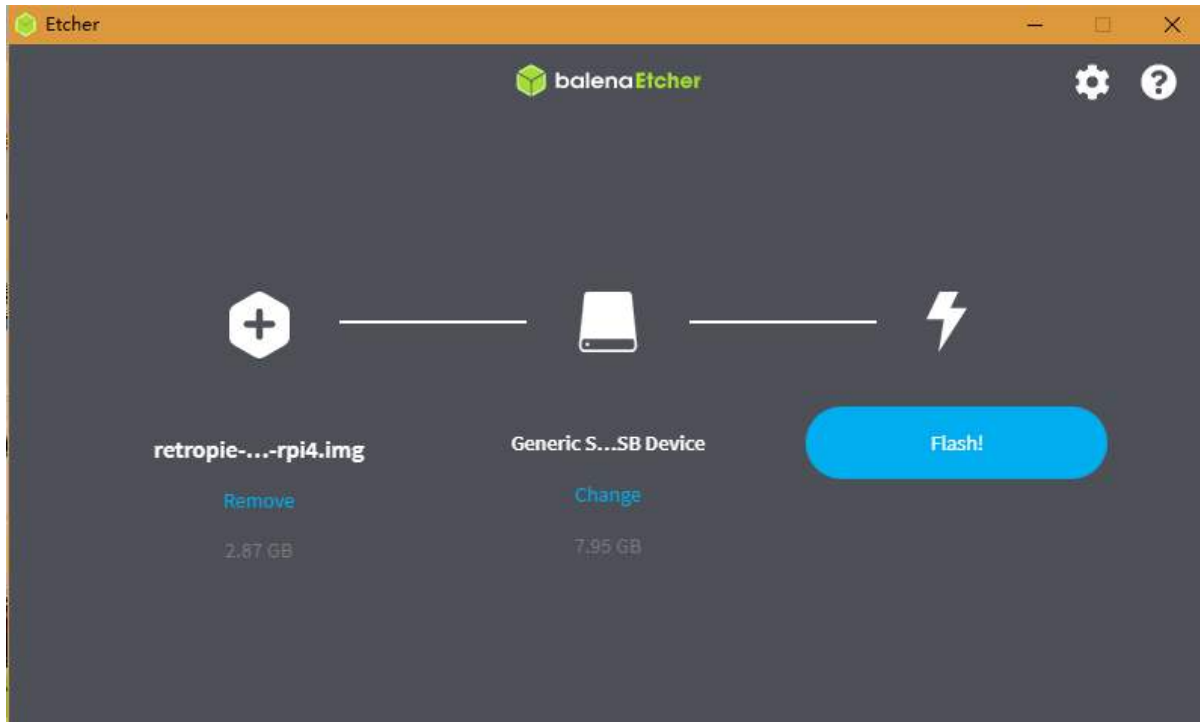

Step 4: Insert the micro-SD card into the Raspberry Pi, and press the power button to boot up the system.

5.2.4 RetroPie Configuration

After the Raspberry Pi boots up, the Controller and WiFi settings should be configured, as well as transferring game ROMs. A keyboard and a gamepad are needed when doing these steps.

The detailed steps are shown in the video:

Note: The display for the video is not a 7inch Touch Screen, it's another one of our products, but the configuration method is the same on the RetroPie.

Note:

1. You can also go to RetroPie official website to detailed tutorial: [RetroPie Docs](#).
 2. RetroPie allows you to turn your Raspberry Pi or PC into a retro-gaming machine. But because of the nature/complexity of copyright/intellectual property law (country-specific), RetroPie doesn't provide ROMs for games. If you want to get them, you can download from the forum or Google to find the sources, then place one ROM under the directory of `RetroPie emulator`.
-

Below is an example using the ROM of Super Mario 3.



5.3 3D Printer Monitor

When using a 3D printer, we will need to use OctoPrint. It is an open source 3D printer controller application, which provides a web interface for the connected printers. It displays printers' status and key parameters and allows user to schedule prints and remotely control the printer.

Please refer to the detailed installation tutorial for OctoPrint: <https://community.octoprint.org/t/setting-up-octoprint-on-a-raspberry-pi-running-raspbian-or-raspberry-pi-os/2337>.

This tutorial has written very detailed installation steps, which may take a long time and requires more patience.

Note:

- The Raspberry Pi Operating System will need to be installed on the micro-SD card before starting the tutorial.

7-inch DIY Touch Screen

Please refer to *INSTALL THE RASPBERRY PI OS*.

- **Webcam Option:** A camera will need to be installed on this screen for webcam use. Please refer to the tutorial: *Assemble the Camera Module*.
 - **Touch UI Option:** A new Raspberry Pi image might not have an auto start function for Touch UI. Please refer to the tutorial: *Touch UI* to configure the settings for the Touch UI function.
-

5.3.1 Touch UI

If the autostart file is not located in the `~/.config/lxsession/LXDE-pi` path, the file will need to be added manually.

Create the `lxsession` folder and the `LXDE-pi` folder in the `~/config` directory.

```
mkdir ~/.config/lxsession
mkdir ~/.config/lxsession/LXDE-pi
```

Copy the autostart file from the path `/etc/xdg/lxsession/LXDE-pi` to the `~/.config/lxsession/LXDE-pi` folder.

```
cp /etc/xdg/lxsession/LXDE-pi/autostart ~/.config/lxsession/LXDE-pi/autostart
```

Set the permissions of the autostart file to be readable and writable.

```
chmod 644 ~/.config/lxsession/LXDE-pi/autostart
nano .config/lxsession/LXDE-pi/autostart
```

Open the autostart file with a text editor such as Nano, and add the following line to the end of the file to make the Raspberry Pi execute the `startTouchUI.sh` script file on boot.

```
@/home/pi/startTouchUI.sh
```

After restarting the Raspberry Pi, the OctoPrint's Touch UI will open in full screen mode. Press `F11` to exit the full screen mode and enter the desktop.

5.3.2 Make a 3D Model

Click this link: <https://projects.raspberrypi.org/en/projects?hardware%5B%5D=3d-printer>, refer to the official Raspberry Pi tutorial, you can get the 3D model file in the format of `.stl`.

Generally, 3D printers cannot directly process `.stl` files. You need to use **Ultimaker Cura** software to slice them, and then upload them to the 3D printer through **OctoPrint** to print the 3D model file.

Download **Ultimaker Cura**. Since Ultimaker Cura is not available on the Raspberry Pi system, you need to perform the slicing operation on your computer.

Ultimaker Cura

Trusted by millions of users, Ultimaker Cura is the world's most popular 3D printing software. Prepare prints with a few clicks, integrate with CAD software for an easier workflow, or dive into custom settings for in-depth control.



[Download for free](#)

[Get Enterprise edition](#)



Select the version you need.

Choose your operating system

You're almost ready to start 3D printing with Ultimaker Cura. Just let us know which operating system you are using.

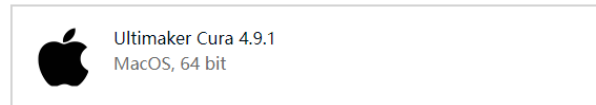
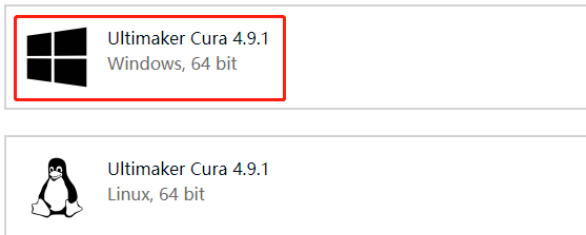

When installing Ultimaker Cura, please note that in the **choose components** step, **Open STL files with Cura** has been checked by default, so that .stl files can be sliced.

If you want to slice other types of model files, check the corresponding option, otherwise you can install it directly.

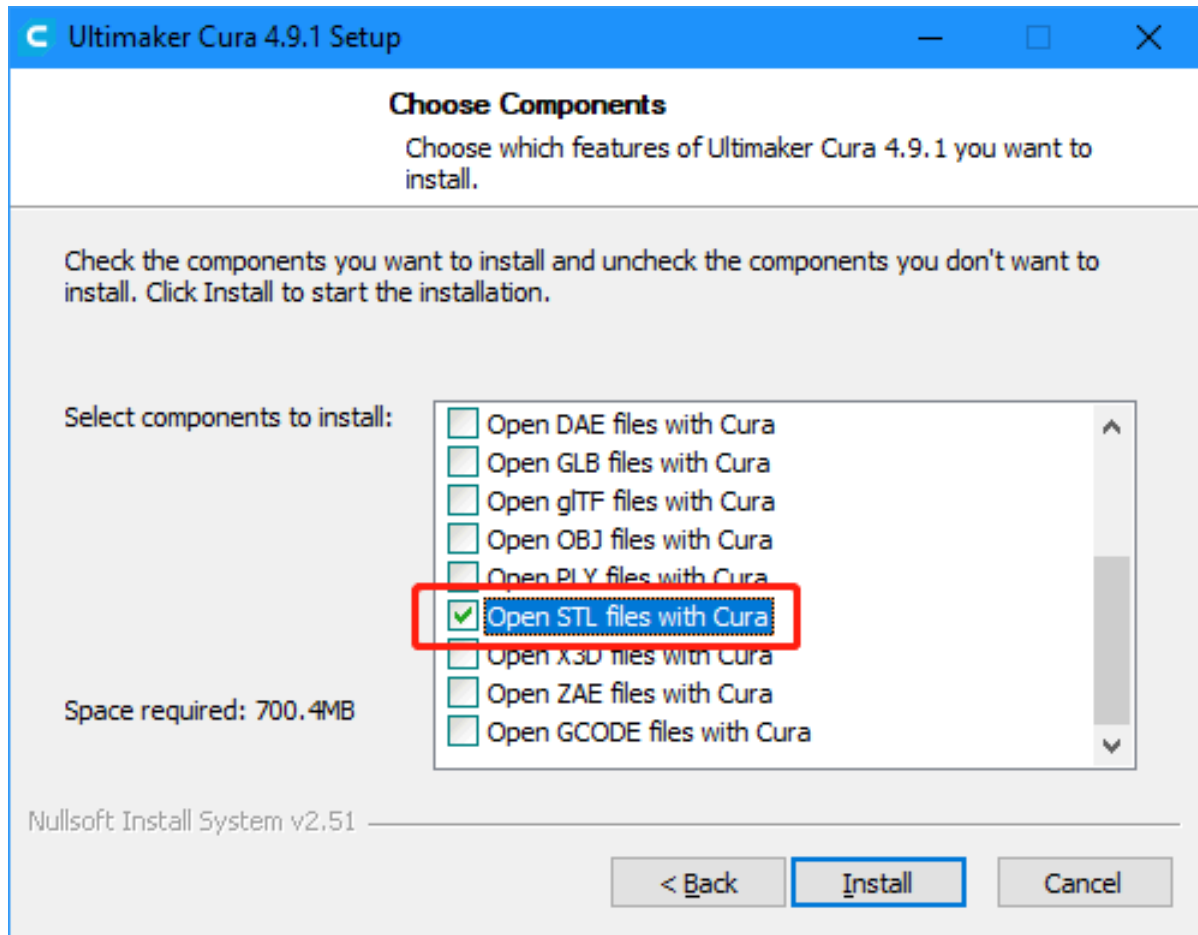

When opening Ultimaker Cura for the first time, there will be a series of configuration prompts. At the **Add a Printer** step, select the model of printer used and click **Next**.

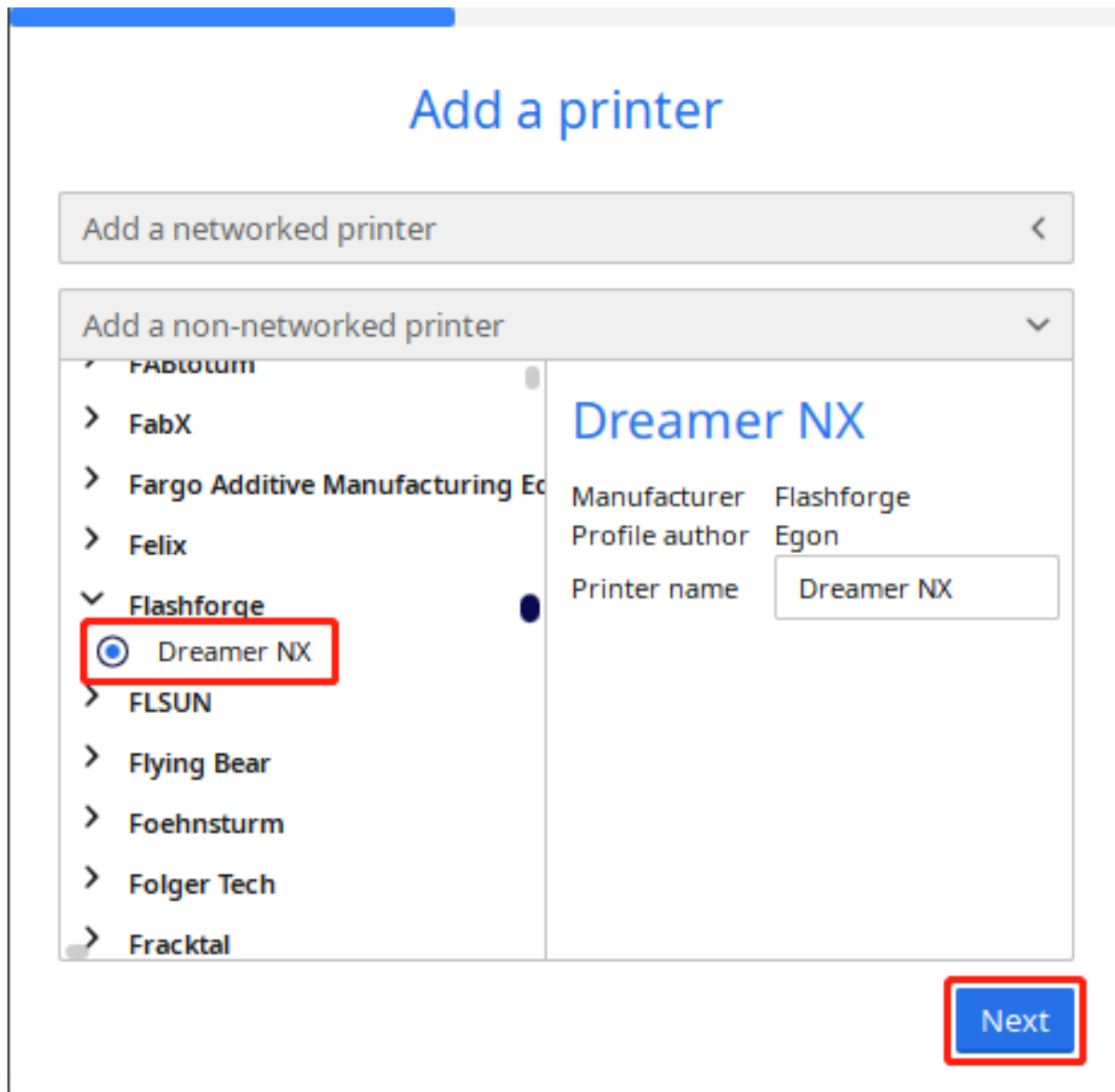

After selecting the correct printer model, verify that the parameters provided by Ultimaker Cura in the Machine Settings page are correct, or change the parameters directly.

Follow the onscreen prompts to complete the configuration of Ultimaker Cura.

Machine Settings

Dreamer NX

Printer

Extruder 1

Printer Settings	Printhead Settings
X (Width) <input style="width: 80%;" type="text" value="230.0 mm"/>	X min <input style="width: 80%;" type="text" value="-15 mm"/>
Y (Depth) <input style="width: 80%;" type="text" value="150.0 mm"/>	Y min <input style="width: 80%;" type="text" value="-25 mm"/>
Z (Height) <input style="width: 80%;" type="text" value="140.0 mm"/>	X max <input style="width: 80%;" type="text" value="40 mm"/>
Build plate shape <input style="width: 80%;" type="text" value="Recta..."/>	Y max <input style="width: 80%;" type="text" value="35 mm"/>
Origin at center <input checked="" type="checkbox"/>	Gantry Height <input style="width: 80%;" type="text" value="30.0 mm"/>
Heated bed <input checked="" type="checkbox"/>	Number of Extruders <input style="width: 80%;" type="text" value="1"/>
Heated build volume <input type="checkbox"/>	Apply Extruder offsets to <input checked="" type="checkbox"/> Code
G-code flavor <input style="width: 80%;" type="text" value="Marlin"/>	
Start G-code	End G-code
<input style="width: 100%;" type="text"/>	<input style="width: 100%;" type="text"/>

Once Ultimaker Cura has successfully launched, click the **Folder** icon in the upper left-hand corner and browse to the folder with the .stl 3D model file that needs to be sliced, and click **Open** to add the .stl file to Ultimaker Cura's library.

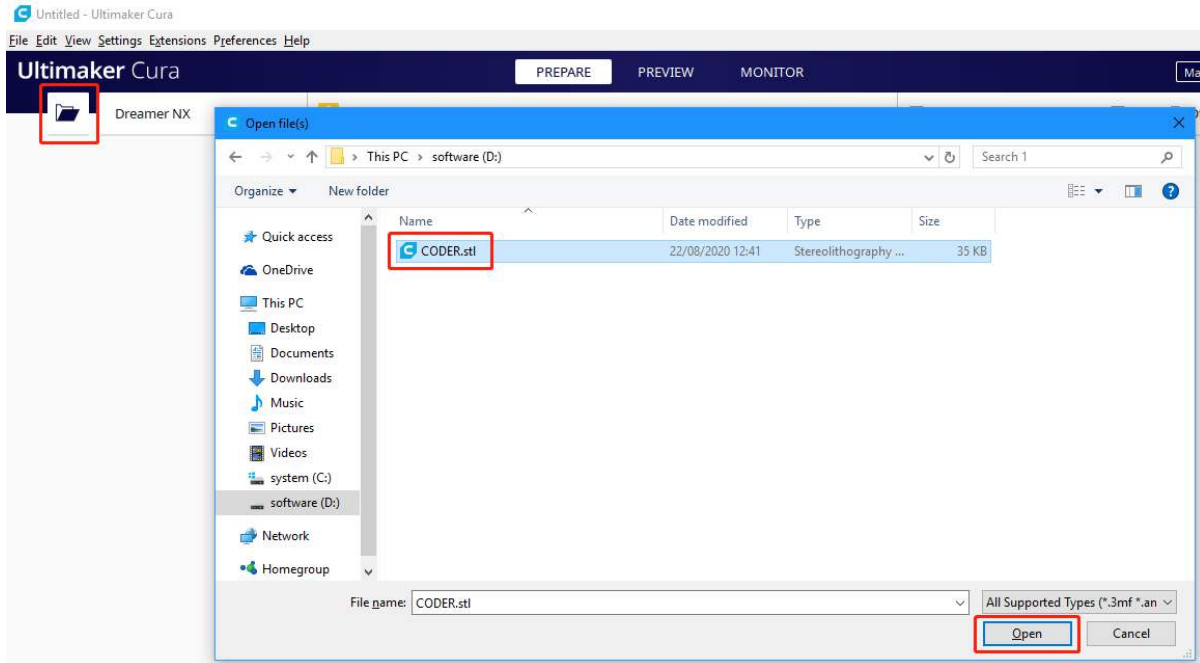

After the file has been added, click the **Slice** option in the lower right-hand corner, and Ultimaker Cura will automatically perform the slicing operation.

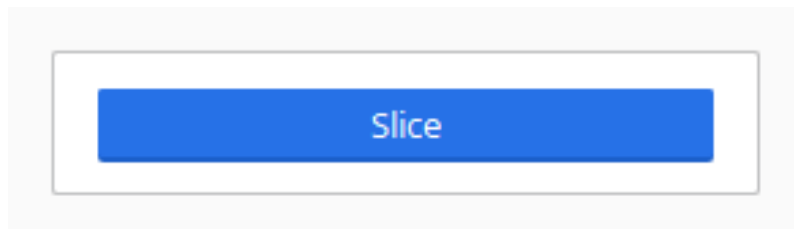

After slicing is complete, click the **Save to Disk** option in the lower right corner to save the sliced file locally.

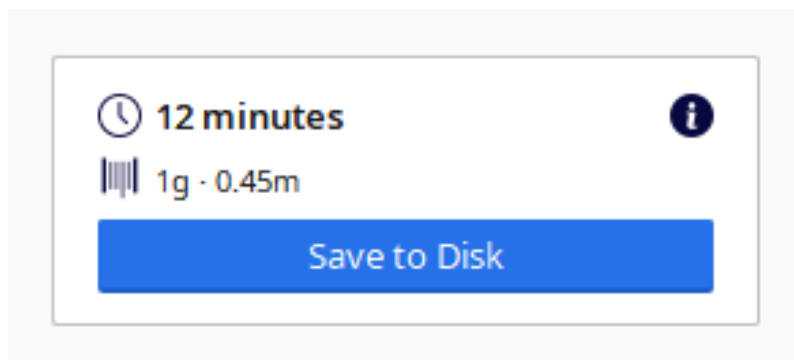

Select the type of file extension recognized by the 3D printer, then click **Save**.

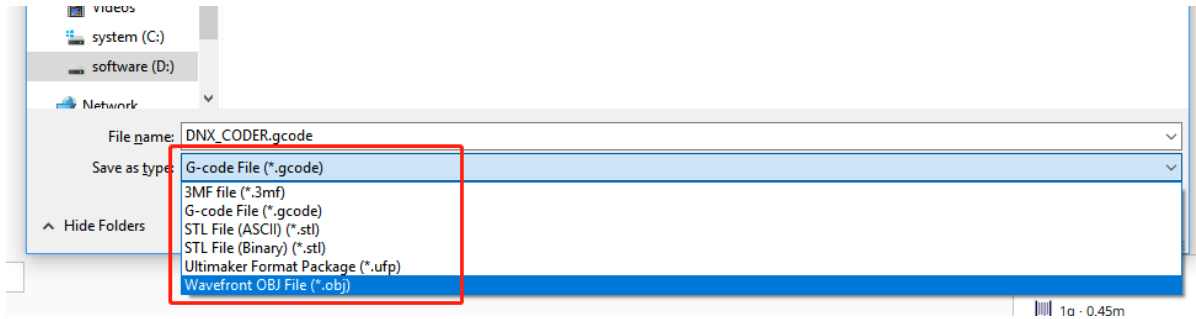

5.3.3 Print 3D Model

After the .stl file has been sliced, the 3D model file can be sent to the 3D printer through OctoPrint to be printed.

Open the Raspberry Pi's browser, and enter `http://192.168.18.179/?#temp` to log in to OctoPrint.

Note: Before logging in to the OctoPrint's web UI, OctoPrint will first need to have been successfully installed on the Raspberry Pi.

The IP address 192.168.18.179 will need to be replaced with the local IP address of the Raspberry Pi. Hover the cursor over the WiFi icon on the Raspberry Pi desktop, and the local IP address will be displayed.



Now you have entered OctoPrint.

The screenshot displays the OctoPrint web interface. On the left, the 'Connection' panel shows settings for Serial Port (AUTO), Baudrate (AUTO), and Printer Profile (FlashForge). The 'State' panel indicates the printer is 'Offline' with an error message: 'Error: No more candidates to test, and no working port/baudrate combination detected.' Below this, there are buttons for 'Print', 'Pause', and 'Cancel'. The 'Files' panel at the bottom left has a search bar.

The main area shows the 'Temperature' control panel. It features a graph with a grid from 50°C to 300°C on the y-axis and time from -30 min to -22 min on the x-axis. A green octopus mascot is overlaid on the graph. The graph shows two data series: 'Actual T: 35.0°C' (red line) and 'Target T: off' (pink line), and 'Actual Bed: 31.0°C' (blue line) and 'Target Bed: off' (purple line). Below the graph is a control table:

	Actual	Target	Offset
Tool	0.0°C	off °C	0 °C
Bed	0.0°C	off °C	0 °C

Click the **Upload** option to select the sliced 3D model file.

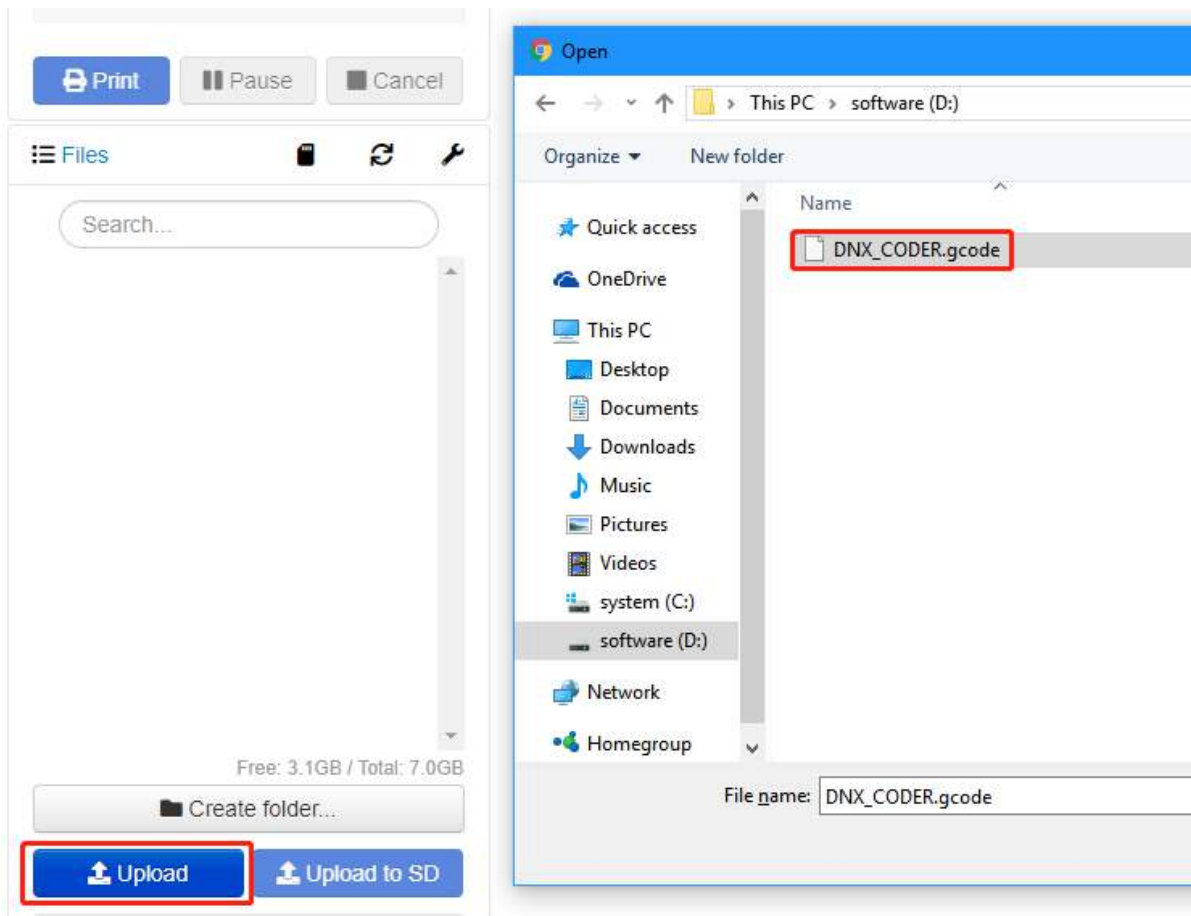

Click the **print** icon. The 3D printer will start to print the 3D model file after the slicing process is complete.

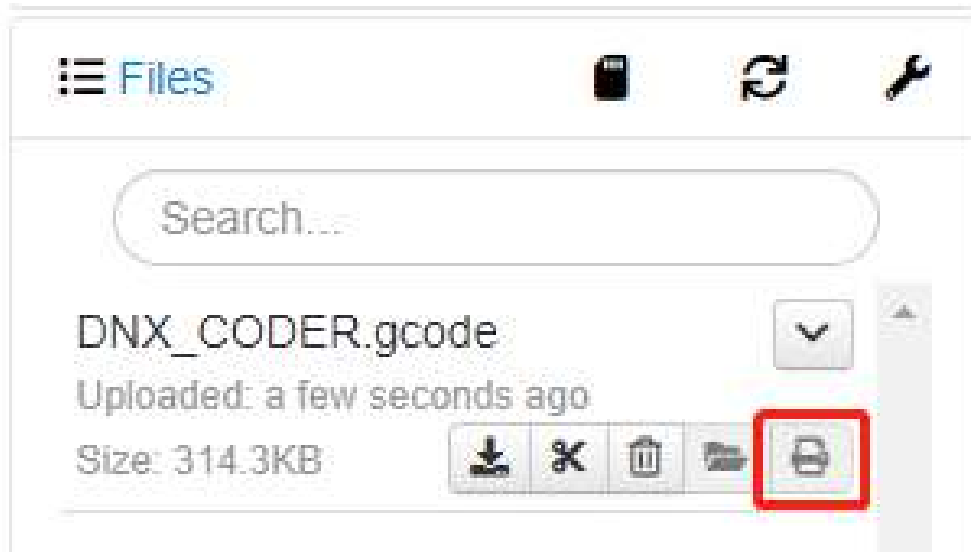

If you have transferred the sliced file to the Raspberry Pi, you can also open the OctoPrint UI in Raspberry Pi to print.

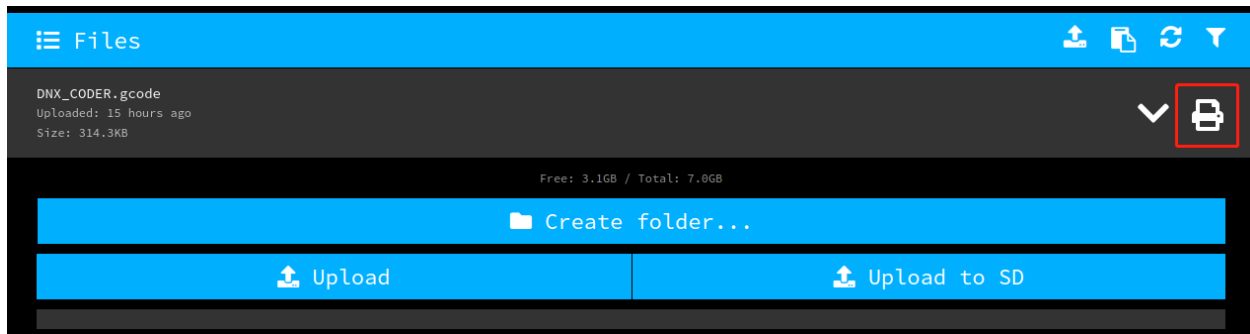

5.3.4 Video

The following video shows that after installing OctoPrint, connect your 3D printer and this screen through a USB cable upload the designed 3D file, and then use the camera to monitor the printing process.

The temperature can also be monitored to prevent the 3D printer from getting too hot or cold, which will affect the printed 3D model.

5.4 Home Assistant



Home Assistant is a Python-based open source smart home system that supports smart home devices of many brands and can easily implement voice control and automation of the devices. You can run Home-assistant on the Raspberry Pi, without having to send your data out onto the internet. This means that you have total control over your data, limit the amount of internet traffic from your smart devices, and tighten up security.

Expand Viewing

Here are some projects made by others that combine Raspberry Pi and Home Assistant.

- [My cheap smart home system | HomeAssistant Wall Panel - AGT Designs](#)
- [Getting started with Home Assistant - JuanMTech](#)
- [DIY Home Automation Intruder Alarm System! || Home Assistant + Raspberry Pi + ESP8266 - GreatScott!](#)

Quick Guide

5.4.1 Install Home Assistant

Install Docker

7-inch DIY Touch Screen

Here will introduce how to use the container environment to install and run Home Assistant. We recommend using Docker as the container environment. The way to install Docker is very simple, just run the following commands.

```
curl -fsSL https://get.docker.com -o get-docker.sh
sudo sh get-docker.sh
```

Note: You can see more details in [Install Docker Engine on Debian](#).

Install Home Assistant

After installing the container environment, if you are using **Raspberry Pi 3**, run the following commands to install the Home Assistant.

```
sudo docker run -d \
--name homeassistant \
--privileged \
--restart=unless-stopped \
-e TZ=MY_TIME_ZONE \
-v /home/pi/homeassistant:/config \
--network=host \
ghcr.io/home-assistant/raspberrypi3-homeassistant:stable
```

If you are using **Raspberry Pi 4**, run the following commands to install the Home Assistant.

```
sudo docker run -d \
--name homeassistant \
--privileged \
--restart=unless-stopped \
-e TZ=MY_TIME_ZONE \
-v /home/pi/homeassistant:/config \
--network=host \
ghcr.io/home-assistant/raspberrypi4-homeassistant:stable
```

Note: For more details, please see [Install Home Assistant Container](#).

Start the Home Assistant Service

After the installation is complete, you can run the following command to start Home Assistant.

```
sudo docker start homeassistant
```

Use the following command to close Home Assistant.

```
sudo docker stop homeassistant
```

Restart Home Assistant with the following command.

```
sudo docker restart homeassistant
```

Enter Home Assistant Page

Now you can enter `http://<localhost>:8123` in the browser to enter the Home Assistant operation interface. For example, my Raspberry Pi IP is 192.168.6.136, then visit `http://192.168.6.136:8123`.

Note:

1. If you need to configure boot-up, please refer to: [Start the Home Assistant Service at Boot](#)
2. If you need to configure a full screen boot, please refer to: [Enter the Home Assistant Page at Boot](#)

5.4.2 Install and configure ESPHome

Note: If you want to add ESPHome in Home Assistant, then you need to go through this section to install and configure it.

If you don't use it, you can skip this section and go directly to the next one: [Log In](#).

ESPHome is the perfect solution for creating custom firmware for your ESP8266/ESP32 boards.

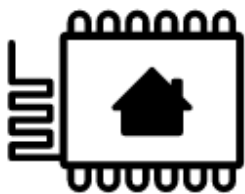

ESPHome

Here's a very quick introduction to how ESPHome works: ESPHome is a tool which aims to make managing your ESP boards as simple as possible. It reads in a YAML configuration file (just like Home Assistant) and creates custom firmware which it installs on your ESP device. Devices or sensors added in ESPHome's configuration will automatically show up in Home Assistant's UI.

Installation

1. Installation dependencies.

```
sudo pip3 install cryptography==2.8
```

2. Install ESPHome, you need to install Python and install the console script through pip3.

Note: Python 3.7 or above is required to install ESPHome 1.18.0 or above.

```
sudo pip3 install esphome
```

Alternatively, there's also a Docker image available for easy installation (the Docker hub image is available for AMD64, ARM and ARM64(AARCH64) right now; if you have another architecture, please install ESPHome through pip or use the Home Assistant add-on:

```
docker pull esphome/esphome
```

3. Open the ESPHome Dashboard.

Note: You need to keep this command running while you are operating in the ESPHome dashboard.

```
esphome dashboard config/
```

Configure ESPHome

7-inch DIY Touch Screen

1. Open a browser and enter ESPHome Dashboard through <http://localhost:6052> or <http://X.X.X.X:6052> (replace X.X.X.X with your Raspberry Pi's IP address).
2. Create configuration.

Click on the “+” to start adding configurations.

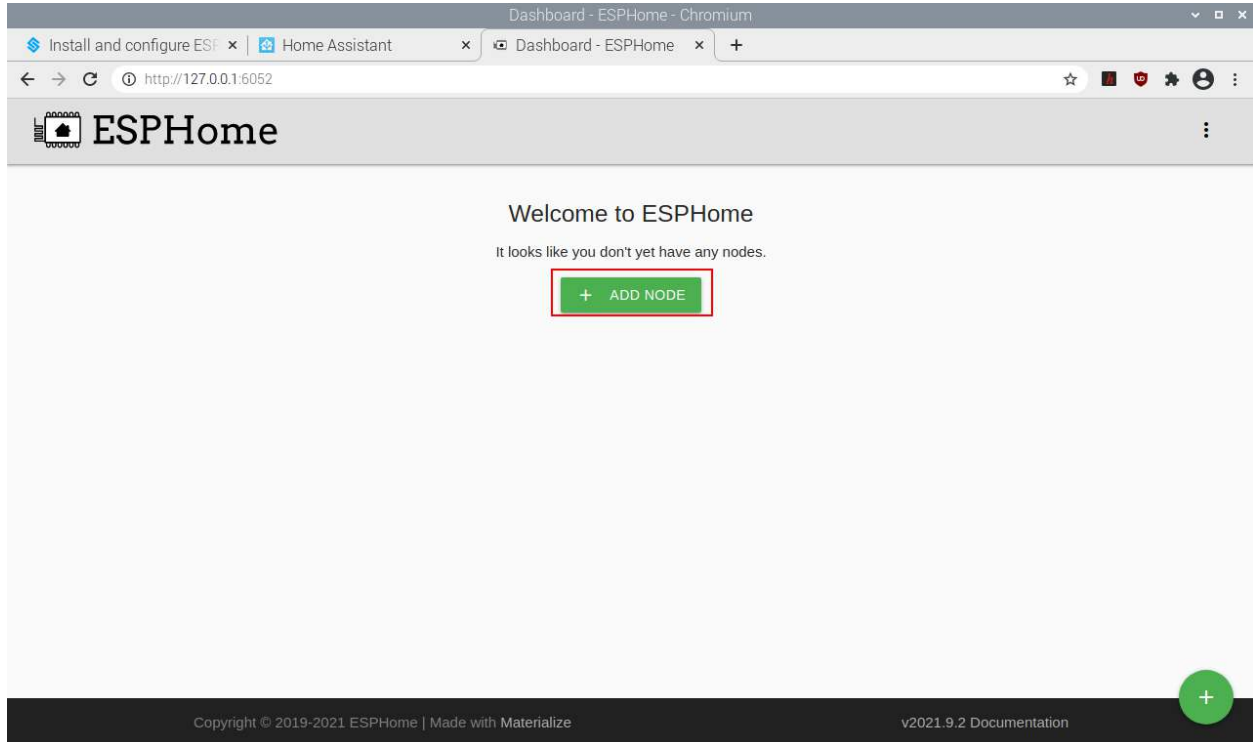

Enter a name and the WiFi and password that you need to have your device connect to and then click **NEXT**.

Dashboard - ESPHome - Chromium

Install and configure ESF x Dashboard - ESPHome x +

← → ↻ ⓘ http://127.0.0.1:6052

 **ESPHome**

Create configuration

Limited functionality because you're not browsing the dashboard over a secure connection (HTTPS).

Name*
esp-light

Enter your Wi-Fi information so your device can connect to your wireless network.

Wi-Fi SSID*

Wi-Fi password

CANCEL NEXT

Copyright © 2019-2021 ESPHome | Made with Materialize

Select the device type (ESP32 for example).

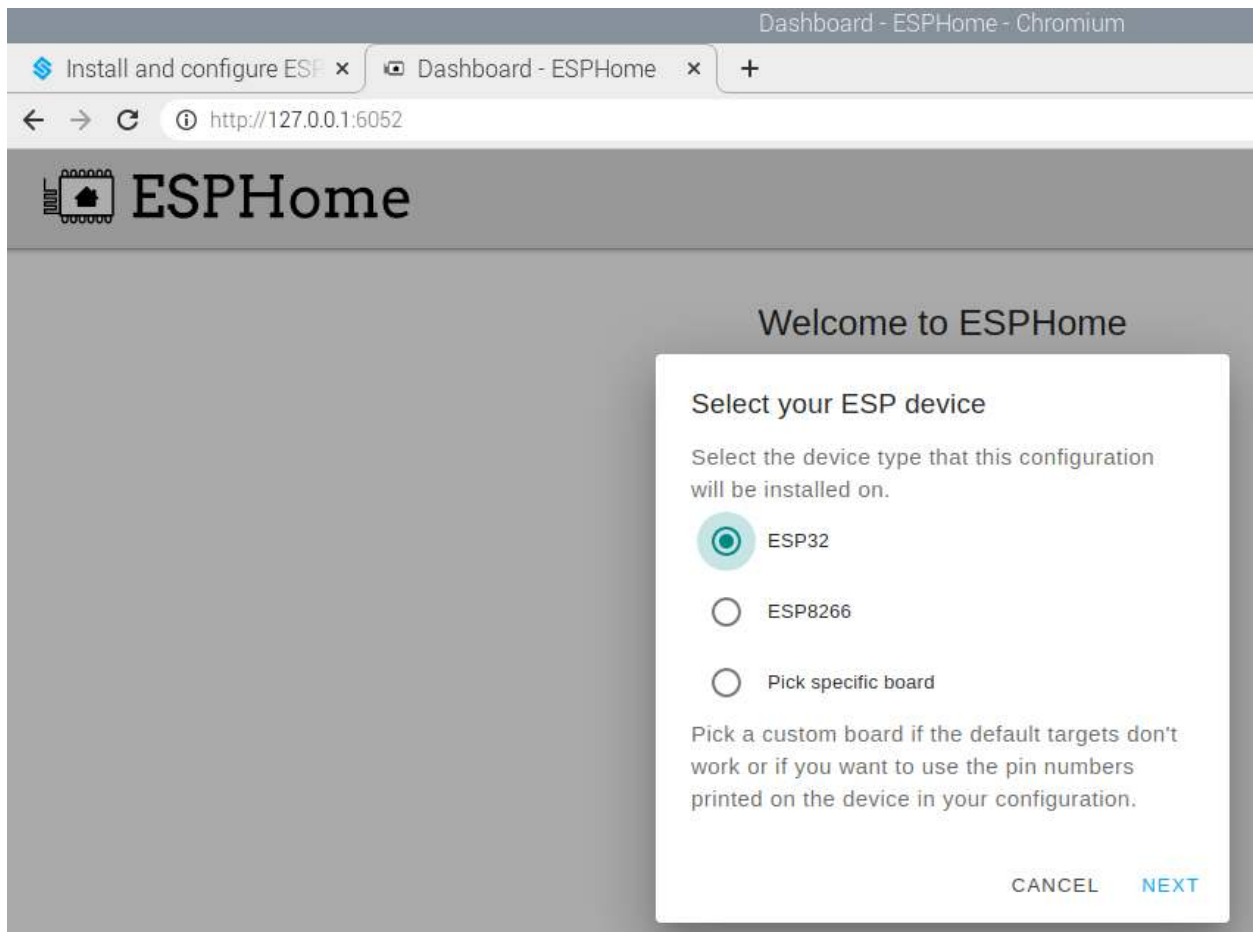

Enter

Once added, you will see them in the Dashboard of ESPHome.

Note: When it is not the first time to add a device, click “+” on the main page, follow the prompts to enter the device name, WIFI and password, select the device type.

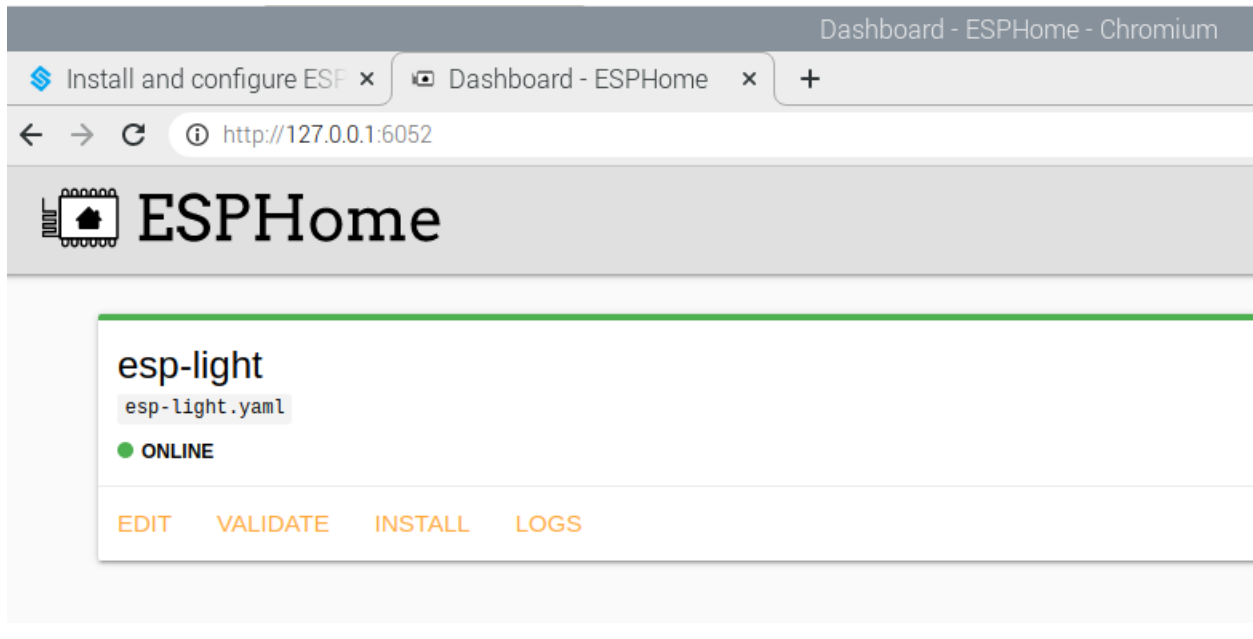

3. Edit the `.yaml` file.

Click **EDIT** in the bottom right corner to go inside the `.yaml` file, you will see the following default components.

Editing: `esp-light.yaml`

```
1  esphome:
2    name: esp-light
3    platform: ESP32
4    board: esp32dev
5
6    # Enable logging
7    logger:
8
9    # Enable Home Assistant API
10   api:
11
12   ota:
13     password: "b741be5b3c53a45b7bca254c5225e7ee"
14
15   wifi:
16     ssid: "MakerStarsHall"
17     password: "sunfounder"
18
19     # Enable fallback hotspot (captive portal) in
20     ap:
21       ssid: "Esp-Light Fallback Hotspot"
22       password: "YreDouoMcDRl"
23
24   captive_portal:
```

- `esphome`: Contains the name, platform, and board type that you set up.
- `logger`: The logger component automatically logs all log messages through the serial port and through MQTT topics.
- `api`: The ESPHome native API is used to communicate with clients directly, with a highly-optimized network protocol. Currently, only the ESPHome tool and Home Assistant use this native API.
- `ota`: With the OTA (Over The Air) update component you can upload your firmware binaries to your node without having to use a USB cable for uploads.
- `wifi`: This core ESPHome component sets up WiFi connections to access points for you. It needs to be in your configuration or otherwise ESPHome will fail in the config validation stage.
- `captive_portal`: The captive portal component in ESPHome is a fallback mechanism for when connecting to

the configured WiFi fails. After 1 minute of unsuccessful WiFi connection attempts, the ESP will start a WiFi hotspot (with the credentials from your configuration).

Now start to add other components. There are a lot of components in the [ESPHome official website](#), including **Sensor Components**, **Output Components**, **Light Components**, etc., Here we take **Binary Light** in **Light Components** as an example.



Quick search

Table of Contents

[Binary Light](#)

- [Configuration variables:](#)
- [See Also](#)

[Join the community](#)

[Follow us on Twitter](#)

[Source Code](#)

Binary Light

The `binary` light platform creates a simple ON/OFF-only light from a [binary output component](#).

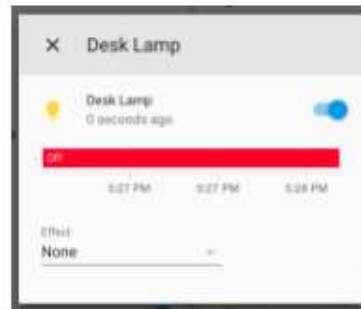

```
# Example configuration entry
light:
  - platform: binary
    name: "Desk Lamp"
    output: light_output

output:
  - id: light_output
    platform: gpio
    pin: GPIO16
```

Add the following code to the end of the `.yaml` file.

```
# Example configuration entry
light:
  - platform: binary
    name: "Desk Lamp"
    output: light_output

output:
  - id: light_output
    platform: gpio
    pin: GPIO16
```

```

22 | password: YREDOUOMCDRI
23
24 captive_portal:
25
26 # Example configuration entry
27 light:
28   - platform: binary
29     name: "Desk Lamp"
30     output: light_output
31
32 output:
33   - id: light_output
34     platform: gpio
35     pin: GPIO16

```

4. Install the `.yaml` file to ESP32 board.

After editing, click **INSTALL** in the lower right corner to compile and install. There are 2 methods for you to choose: Wirelessly and USB Port. But for the first installation you need to connect the ESP32 board to the Raspberry Pi using USB and then choose the second installation method. At a later time you can install and compile via Wirelessly.

It takes about 10 minutes to download the dependencies during the first compilation, so please be patient.

How do you want to install this on your ESP device?

Wirelessly

Requires the device to be online



Plug into this computer

Dashboard needs to be opened via HTTPS



Plug into the computer running ESPHome Dashboard

For devices connected via USB to the server



Click here, if your ESP32 board is plugged into Raspberry Pi.

Manual download

Install it yourself using ESPHome Flasher or other tools



After successful installation, if you connect an LED to GPIO16 in ESP32 board, you will see the LED is lit. Also please record this IP, you will need to fill in this IP when you add ESPHome to Home Assistant.

```
[18:03:51][C][wifi:359]: SSID: maker_star_star1
[18:03:51][C][wifi:360]: IP Address: 192.168.18.254 Record the IP
[18:03:51][C][wifi:362]: BSSID: D0:C7:C0:AC:C5:7F
[18:03:51][C][wifi:363]: Hostname: 'test'
[18:03:51][C][wifi:367]: Signal strength: -53 dB 
[18:03:51][C][wifi:371]: Channel: 6
[18:03:51][C][wifi:372]: Subnet: 255.255.255.0
[18:03:51][C][wifi:373]: Gateway: 192.168.18.1
[18:03:51][C][wifi:374]: DNS1: 192.168.18.1
[18:03:51][C][wifi:375]: DNS2: 0.0.0.0
[18:03:51][C][gpio.output:010]: GPIO Binary Output:
[18:03:51][C][gpio.output:011]: Pin: GPIO16 (Mode: OUTPUT)
[18:03:51][C][logger:189]: Logger:
[18:03:51][C][logger:190]: Level: DEBUG
[18:03:51][C][logger:191]: Log Baud Rate: 115200
[18:03:51][C][logger:192]: Hardware UART: UART0
[18:03:51][C][light:097]: Light 'Switch'
[18:03:51][C][captive_portal:148]: Captive Portal:
[18:03:51][C][ota:029]: Over-The-Air Updates:
[18:03:51][C][ota:030]: Address: test.local:3232
[18:03:51][C][ota:032]: Using Password.
[18:03:51][C][api:095]: API Server:
[18:03:51][C][api:096]: Address: test.local:6053
[18:03:54][D][api.connection:730]: Client 'Home Assistant 2021.8.8 (192.168.18.112)' connected successfully!
```

Note: If there is no response when clicking INSTALL, please clear the browser cache and INSTALL again.

```
sudo rm -rf ~/.cache/chromium
```

ESPHome configuration is complete and you can now add it to Home Assistant.

5.4.3 Log In

1. Please set up a username and password for your Home Assistant.

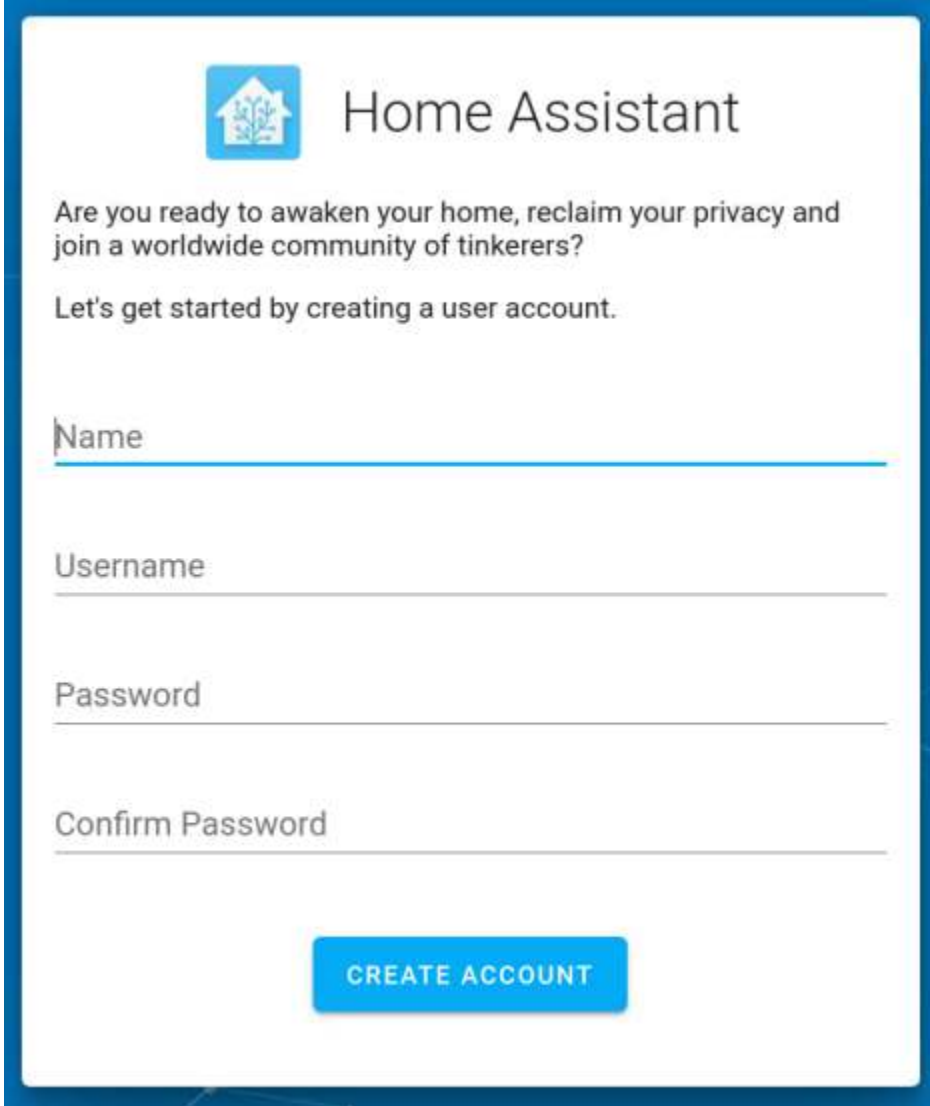

The image shows a digital screen for creating a Home Assistant account. At the top left is the Home Assistant logo, a blue square with a white house icon containing a tree. To its right is the text "Home Assistant" in a large, dark font. Below the logo and title is a short introductory paragraph: "Are you ready to awaken your home, reclaim your privacy and join a worldwide community of tinkerers?" followed by "Let's get started by creating a user account." Below this text are four input fields, each with a label and a horizontal line for text entry: "Name", "Username", "Password", and "Confirm Password". At the bottom center of the form is a blue rectangular button with the white text "CREATE ACCOUNT". The entire form is enclosed in a thick blue border.

2. Create a name for your home and select your region.



Home Assistant

Hello Sunfounder, welcome to Home Assistant. How would you like to name your home?

Name of your Home Assistant installation

Home|

We would like to know where you live. This information will help with displaying information and setting up sun-based automations. This data is never shared outside of your network.

We can help you fill in this information by making a one-time request to an external service. DETECT



Leaflet | © OpenStreetMap, © CARTO

Time Zone	Elevation 0 meters
Unit System	<input checked="" type="radio"/> Metric Celsius, kilograms <input type="radio"/> Imperial Fahrenheit, pounds
Currency Find your value	Currency

NEXT

3. Select the content you want to share to Home Assistant.

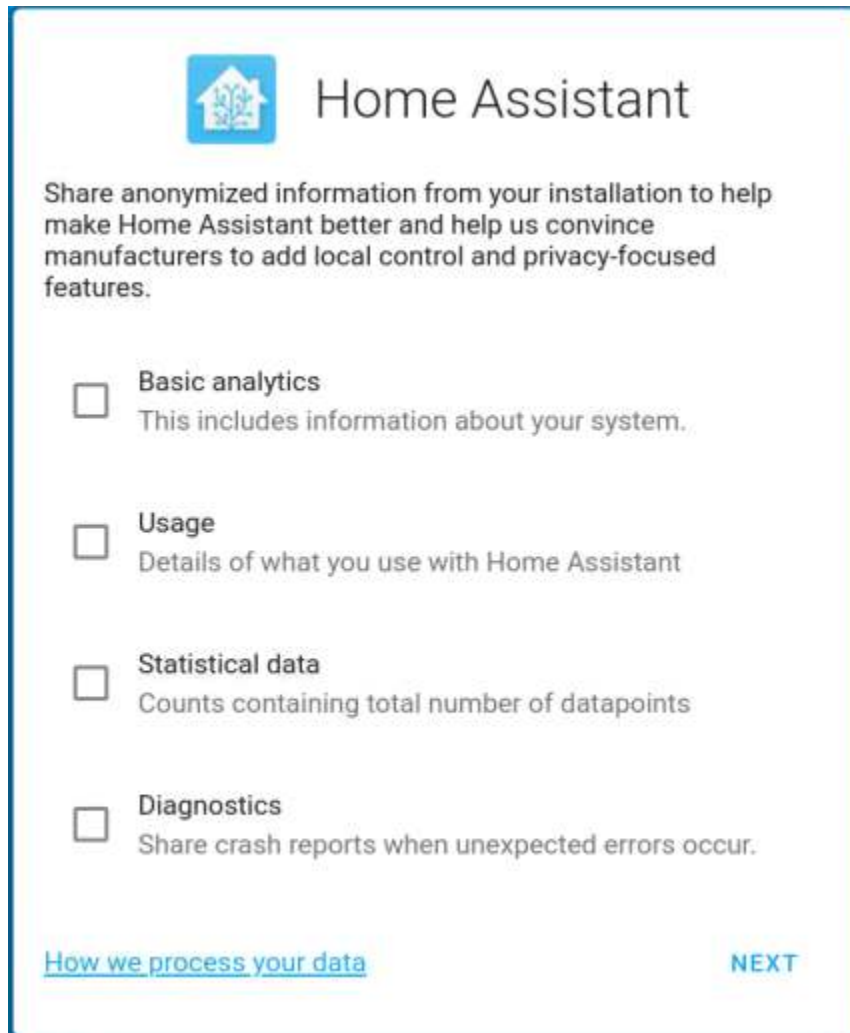

4. You can choose to configure the device now, or later. It is recommended that beginners configure the device later, as the configuration is described in detail later in the tutorial.

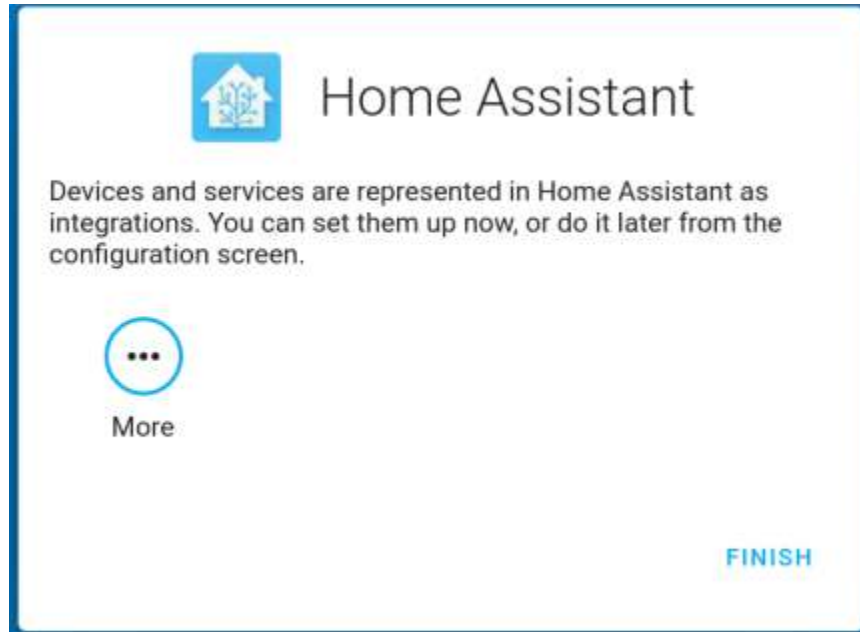

5. After setting up, enter your login username and password in the login screen.

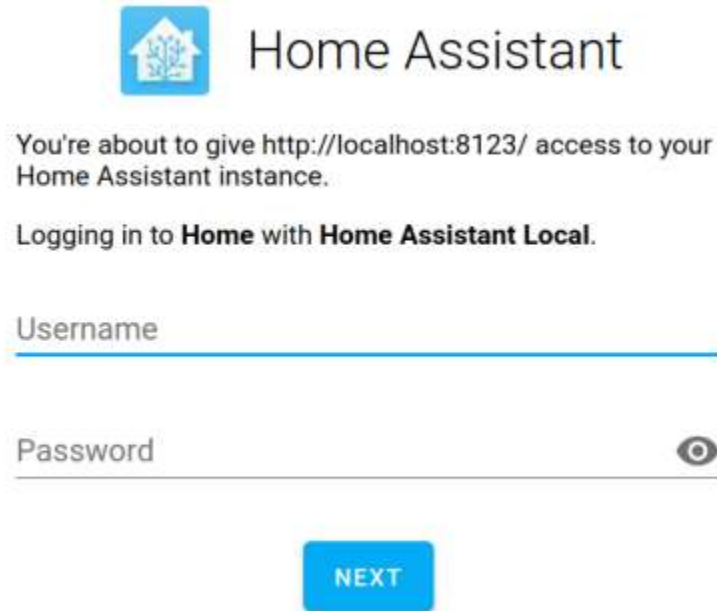
A screenshot of the Home Assistant login screen. At the top left is the Home Assistant logo. To its right is the text "Home Assistant". Below the logo and title, there is a paragraph: "You're about to give <http://localhost:8123/> access to your Home Assistant instance." Underneath this text is another paragraph: "Logging in to **Home** with **Home Assistant Local**." Below the text are two input fields. The first is labeled "Username" and has a blue underline. The second is labeled "Password" and has a blue underline and a small eye icon to its right. At the bottom center of the screen is a blue button with the word "NEXT" in white capital letters.

Note: If the login screen does not jump automatically, please open Home Assistant again via <http://localhost:8123>.

After logging in successfully, you will enter your Home.

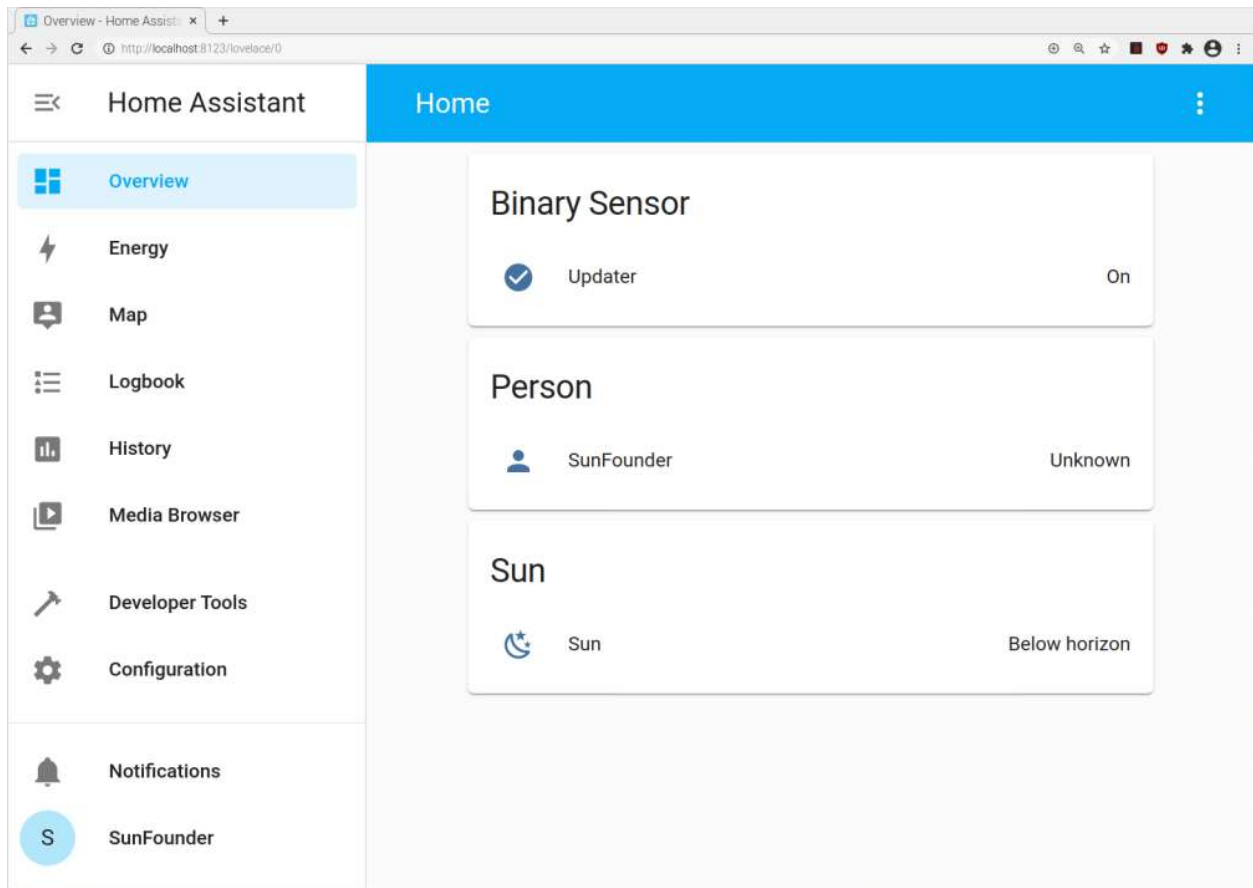

5.4.4 Add Smart Devices

You can add your purchased smart devices to Home Assistant, such as smart sound, smart desk lamp, etc. You can also make your DIY device with ESP32 and add it in.

In this section, you will learn how to add your smart devices.

You need to make sure that your smart device has been assigned an IP. You can complete this step through the corresponding APP of the smart device. For example, the picture below shows a bedside lamp configured with **HomeKit**.

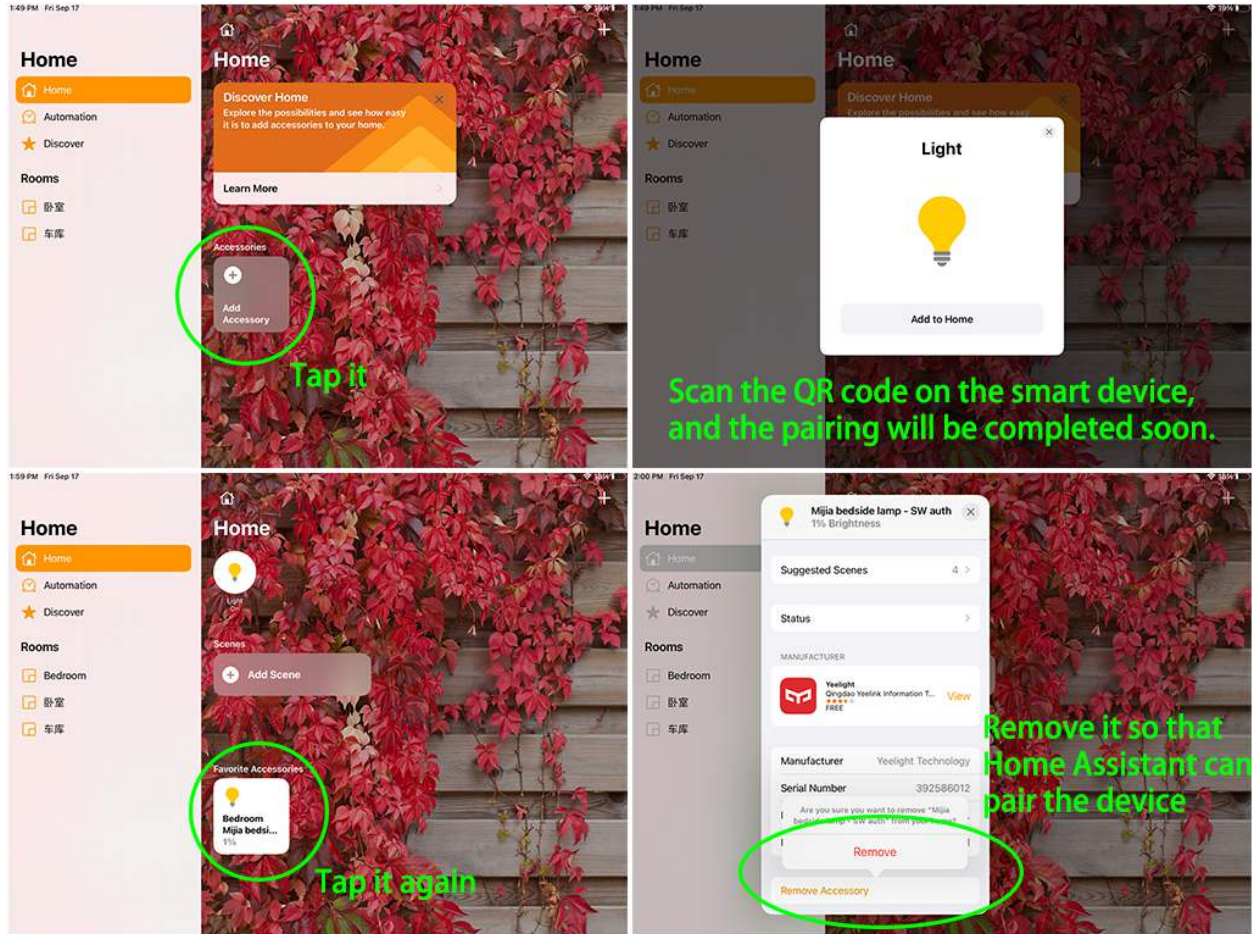

Now back to home assistant(refer to *Log In*), click **Configuration** in the left column, select **Intergrations**.

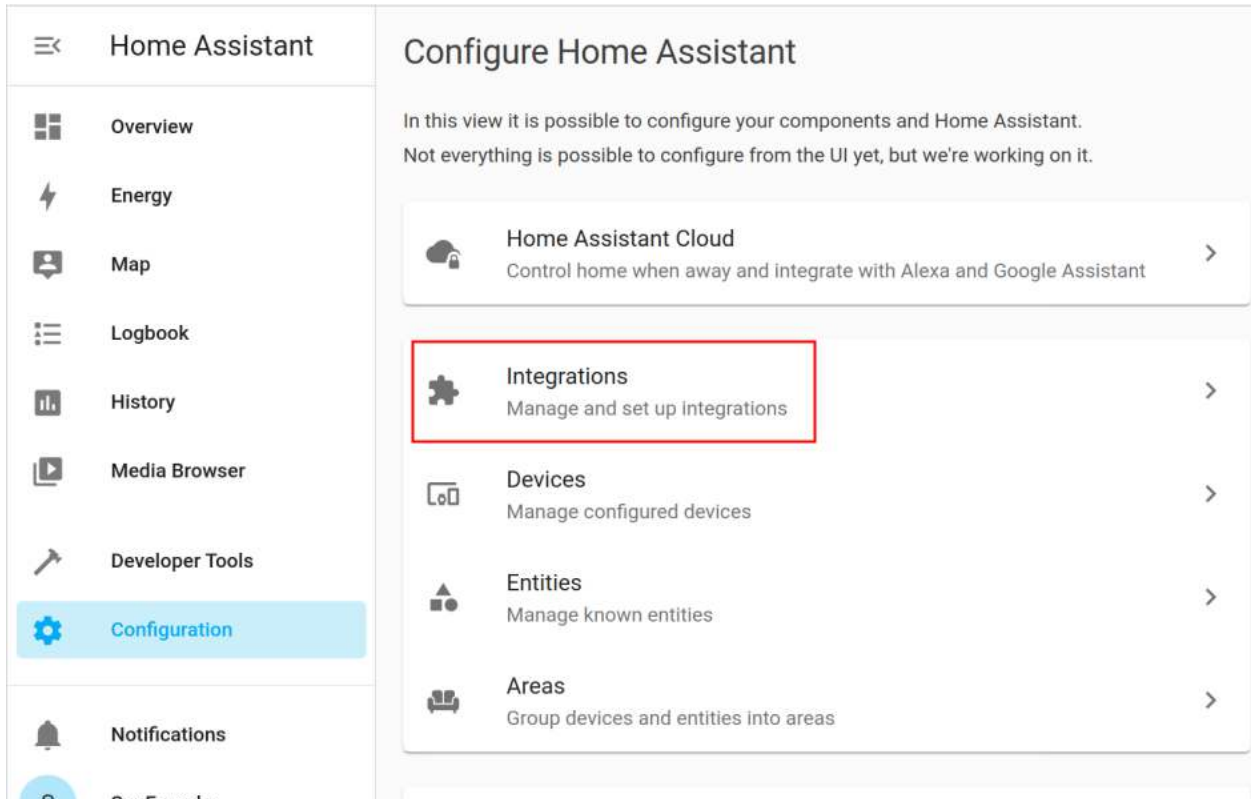

If Home Assistant finds a device on your network, it will display the corresponding integration, which can be easily added with just a few clicks. If your smart device has not been discovered yet, don't worry, click the + **ADD INTEGRATION** button at the bottom right and search for your integration in the list.

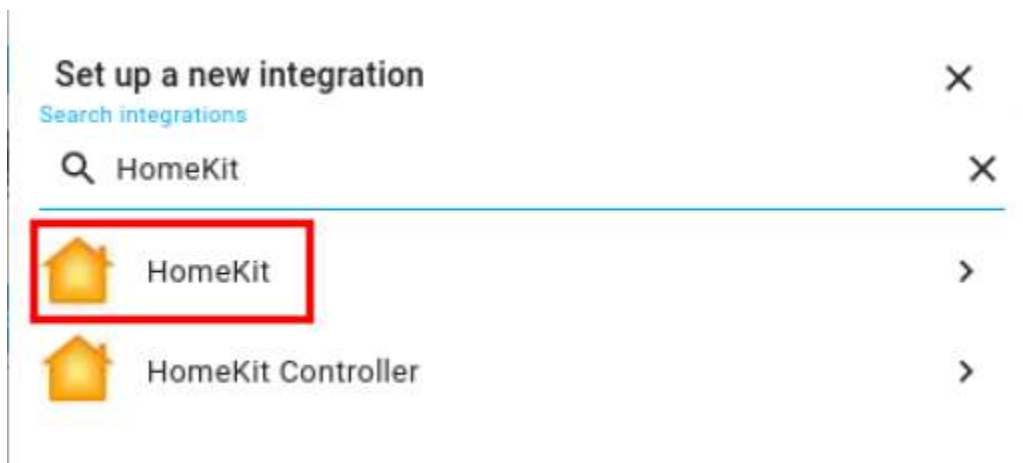

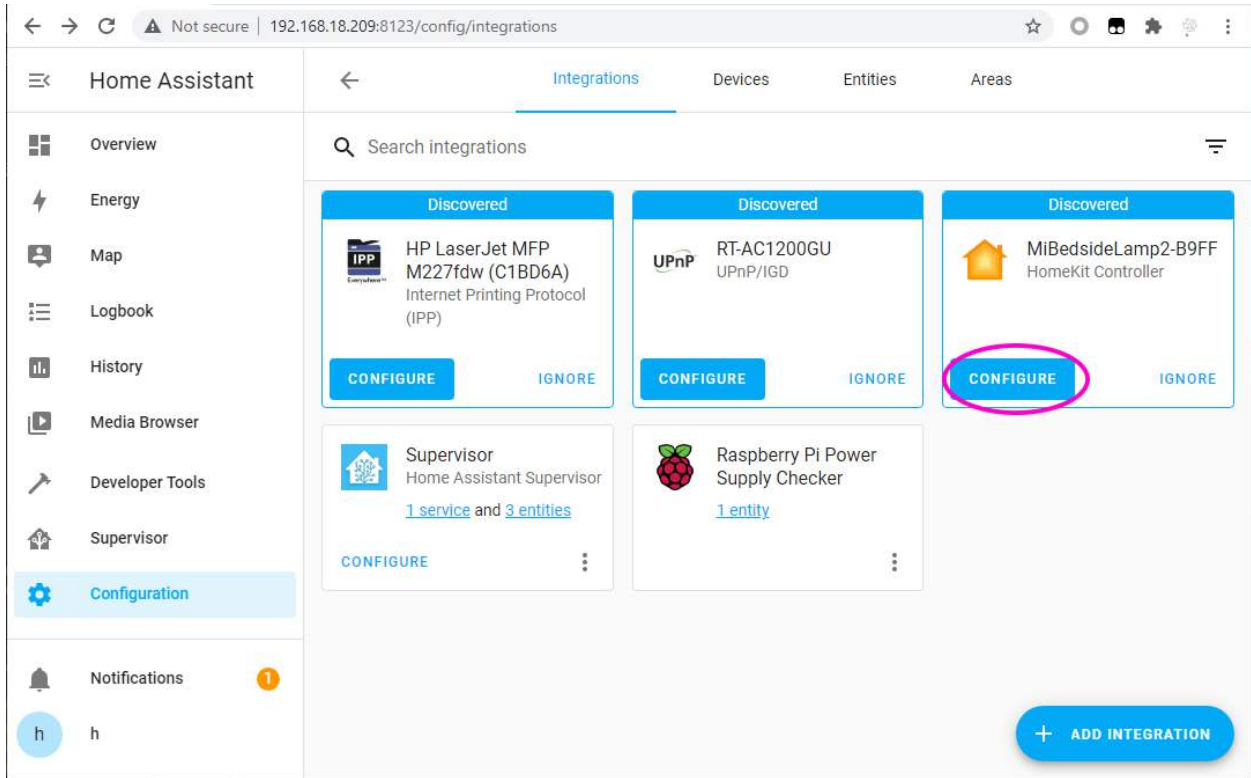

Each integration may be different in use, you can visit [Home Assistant Integration](#) for details.

Return to the Overview page. If the device you just added does not appear, you need to **Edit Dashboard**.

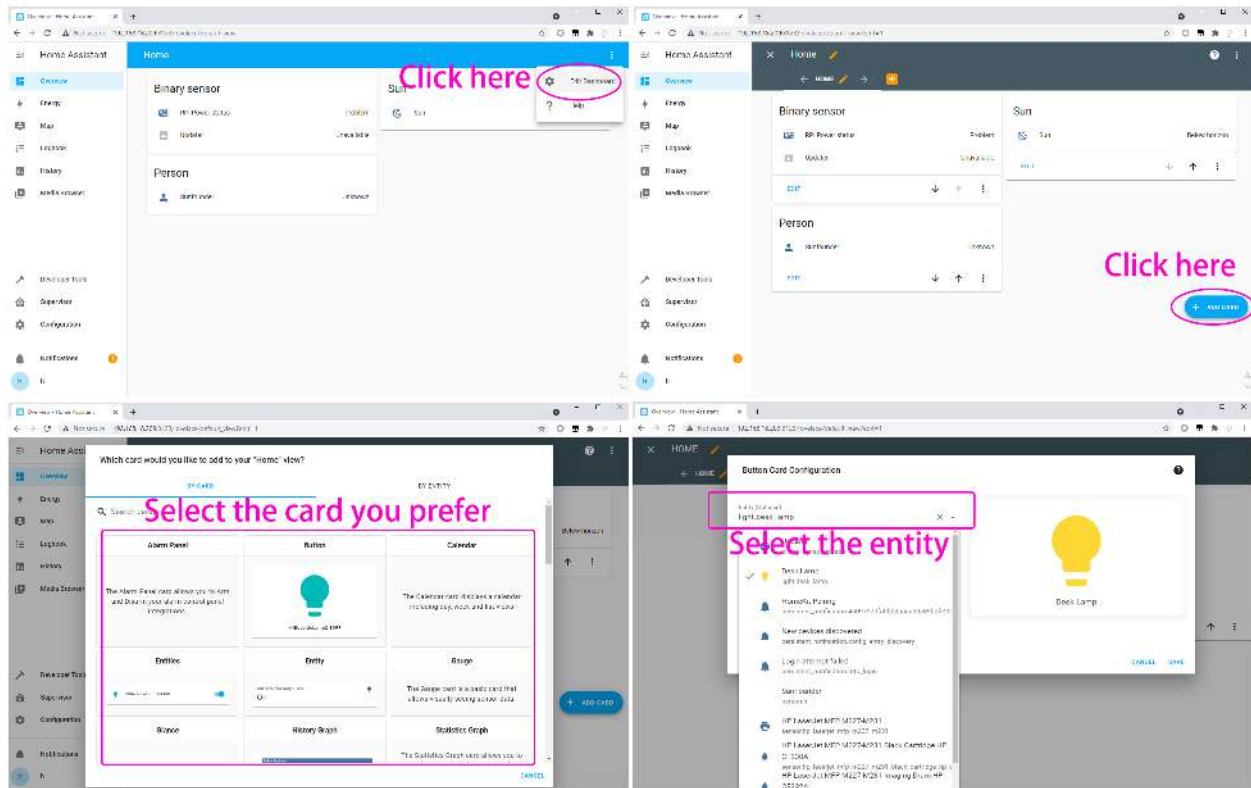

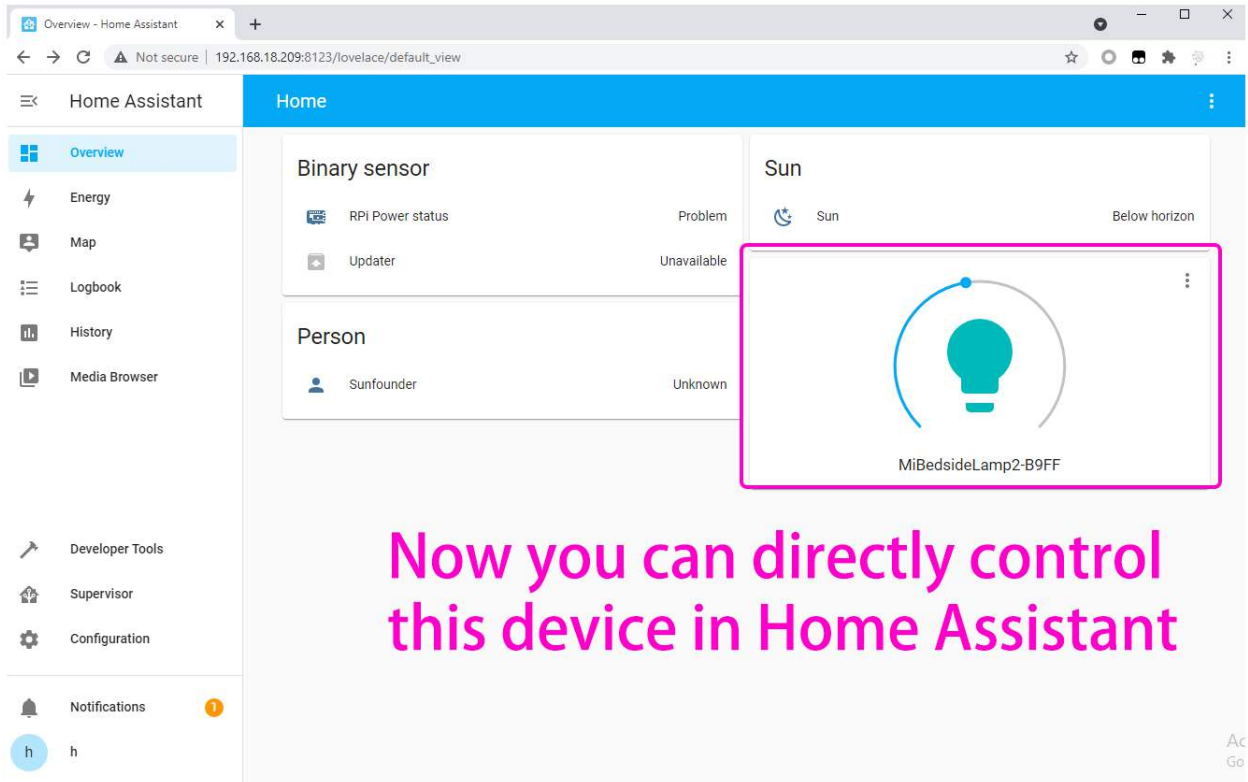

5.4.5 Add DIY Device with ESP32

You can add your purchased smart devices to Home Assistant, such as smart sound, smart desk lamp, etc. You can also make your DIY device with ESP32 and add it in.

In this section, you will learn how to add your DIY device.

Before you start the following operations, you need to complete *Install and configure ESPHome*.

Add Integration

1. Now, visit <http://ip:8123> to access your Home Assistant, then click **Configuration** in the left column and select **Integrations**.

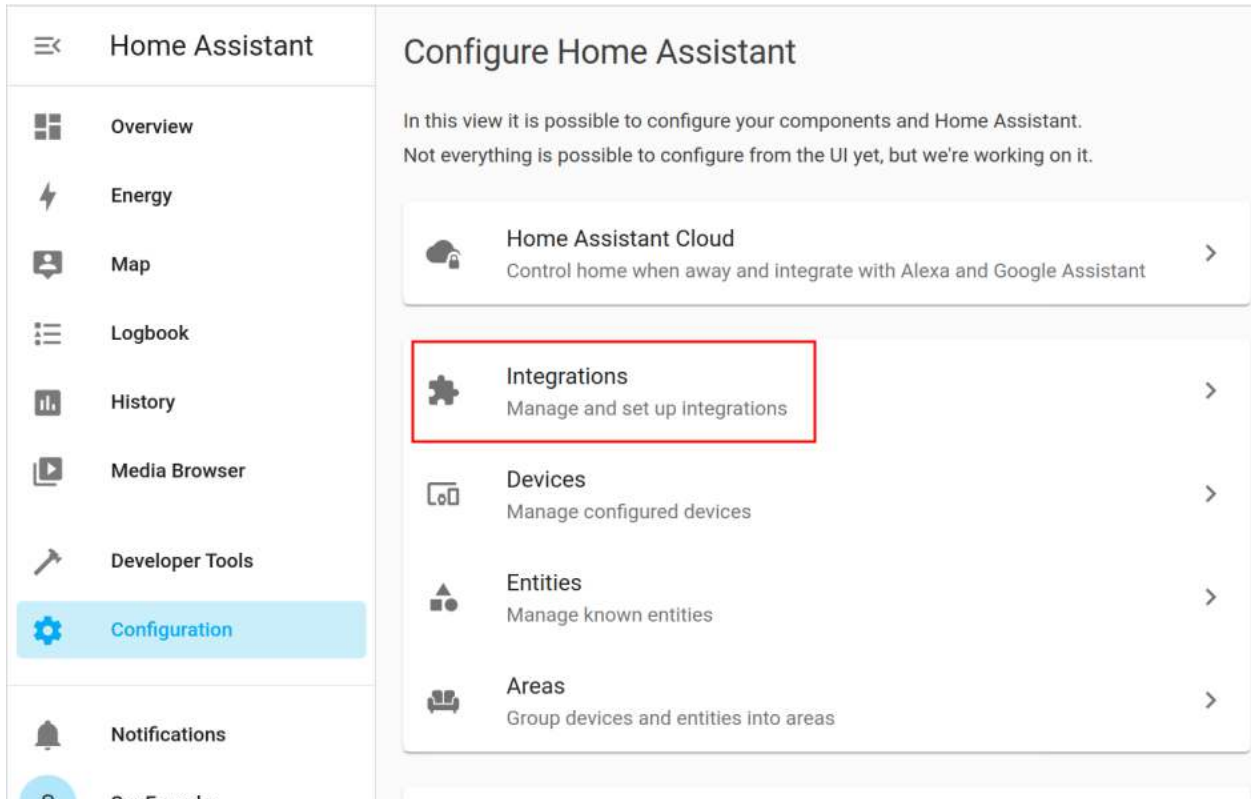

2. If Home Assistant finds a device on your network, it will display the corresponding integration, which can be easily added with just a few clicks. If your smart device is not yet discovered, don't worry, you can add it via the **+ ADD INTERGATION** button at the bottom right.

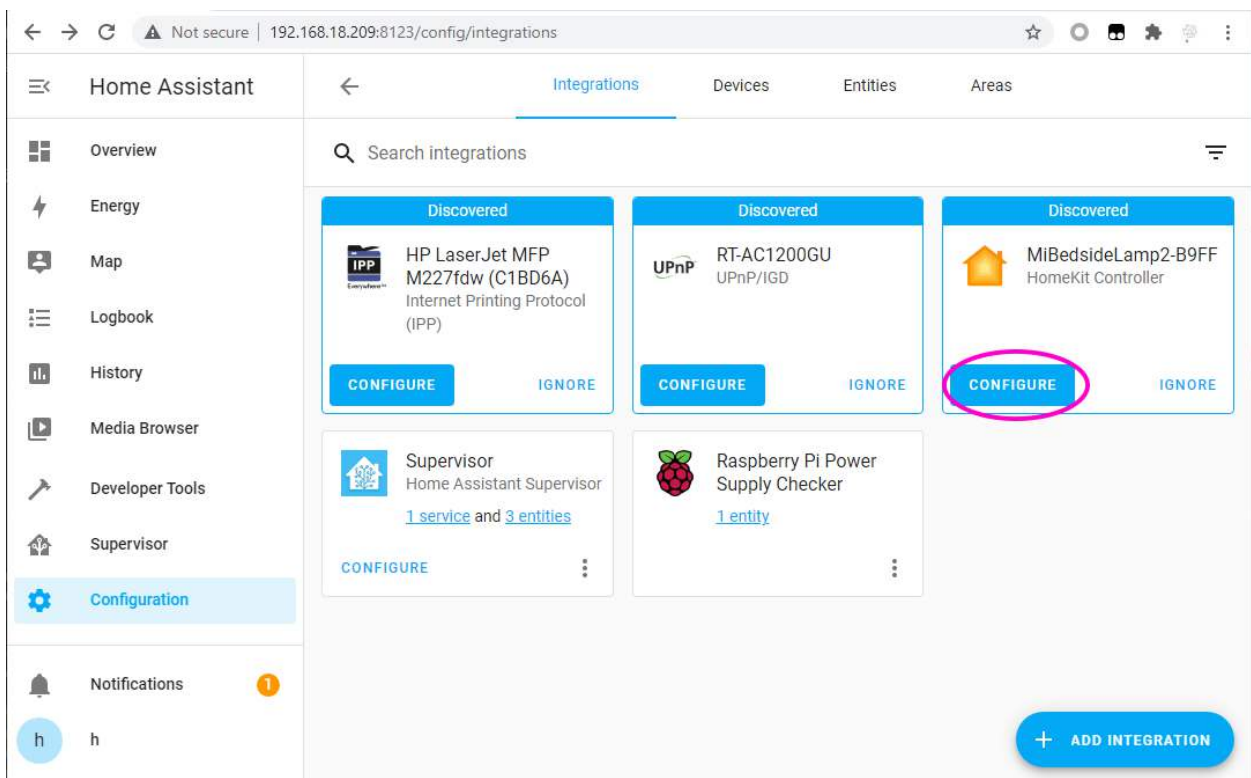

3. Search for ESPHome in the pop-up window and fill in the Host (the IP recorded after the INSTALL step in chapter:ref:Install and configure ESPHome), with the option to place your esp-light in the bedroom, kitchen or other area of your choice.

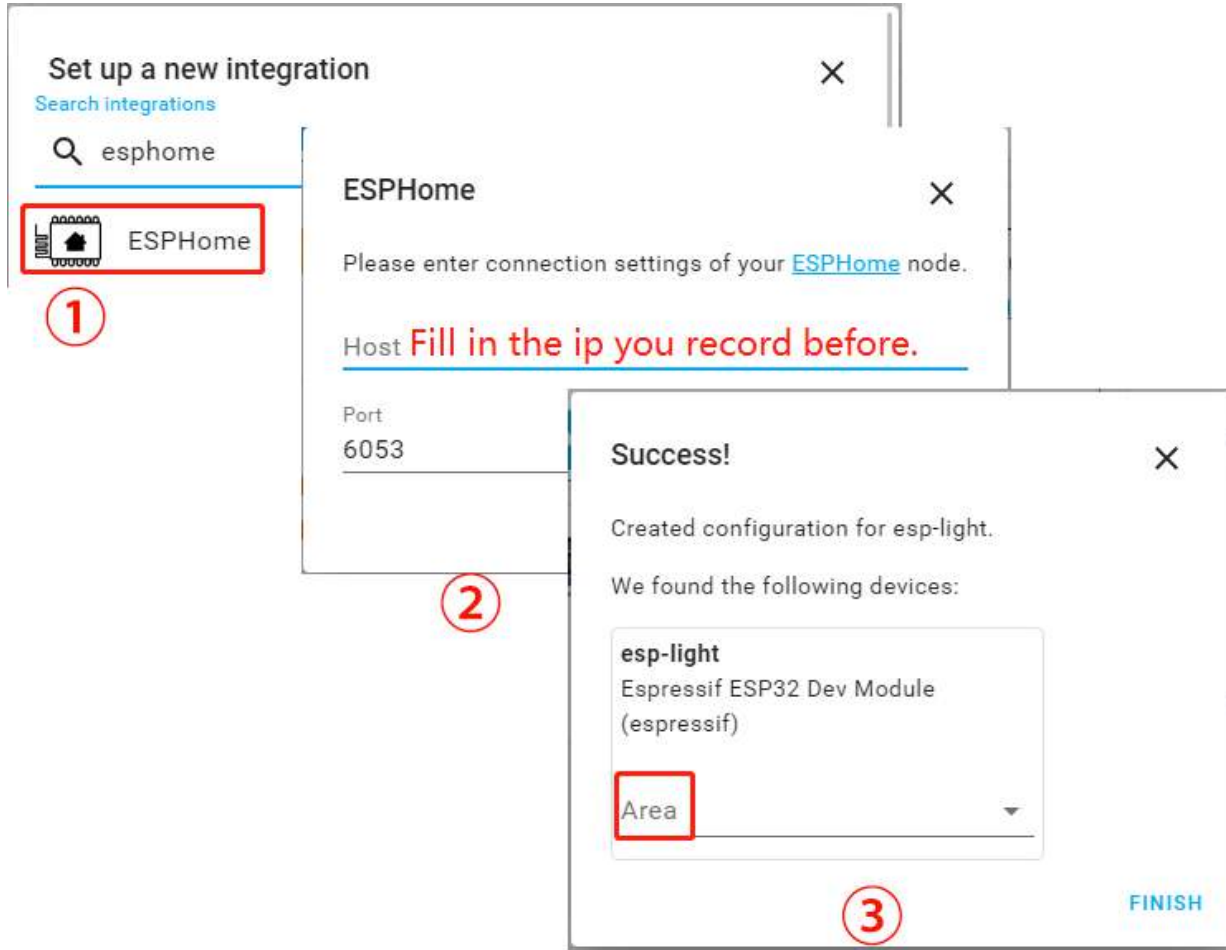

4. After clicking Finish, you will see it in the list.

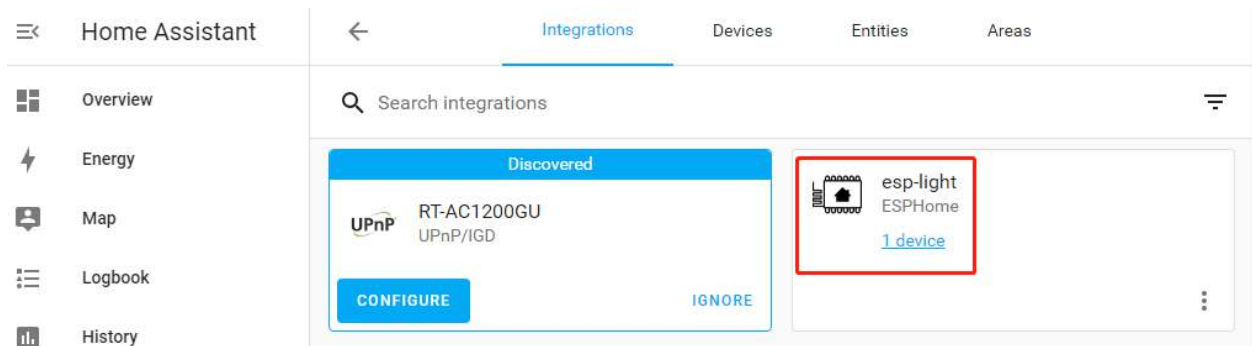

Edit Dashboard

Now a CARD needs to be added to control this esp-light.

Click **Overview** → **Edit Dashboard** → **ADD CARD**, you can select the corresponding CARD according to your needs, for example, select **Button** here, and then select the corresponding Entity.

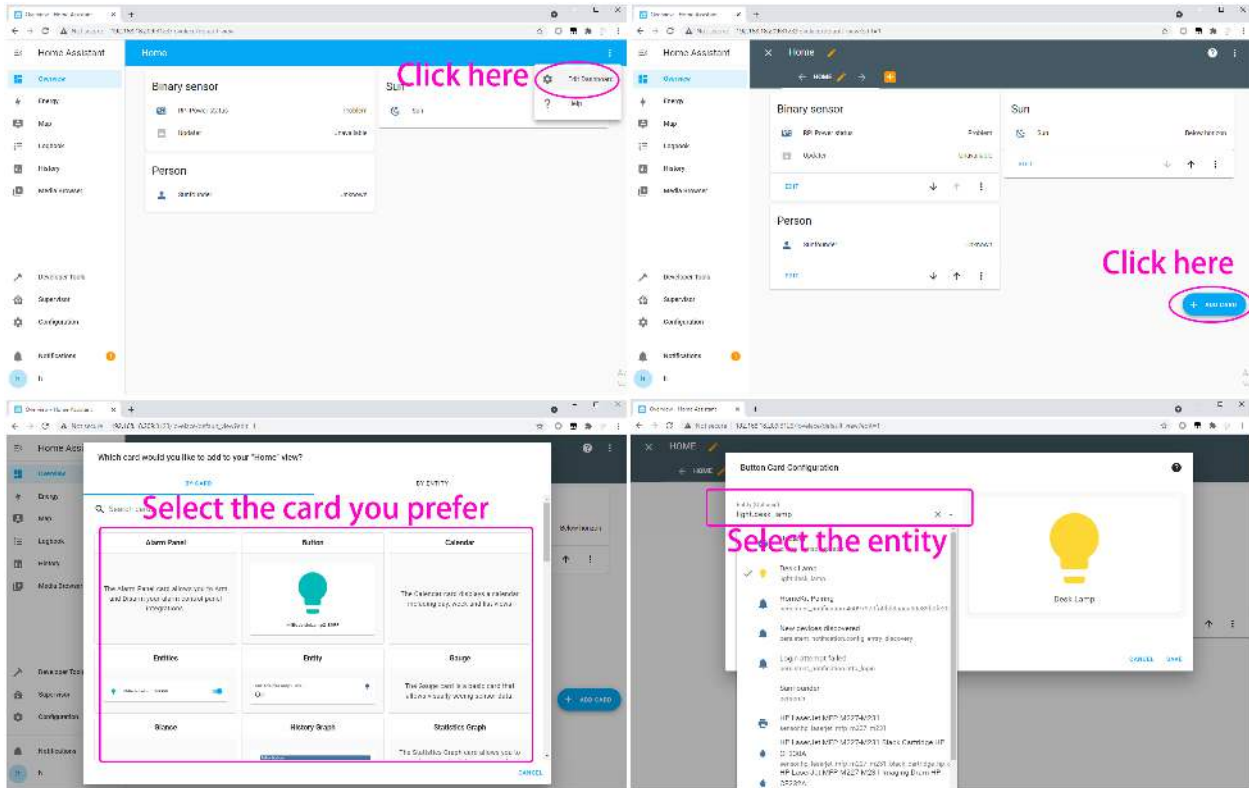

After clicking SAVE, you will be able to use this Button to control the esp-light (if you connect an LED to GPIO16 in ESP32 board, click on the Button to make the LED light up or turn off).

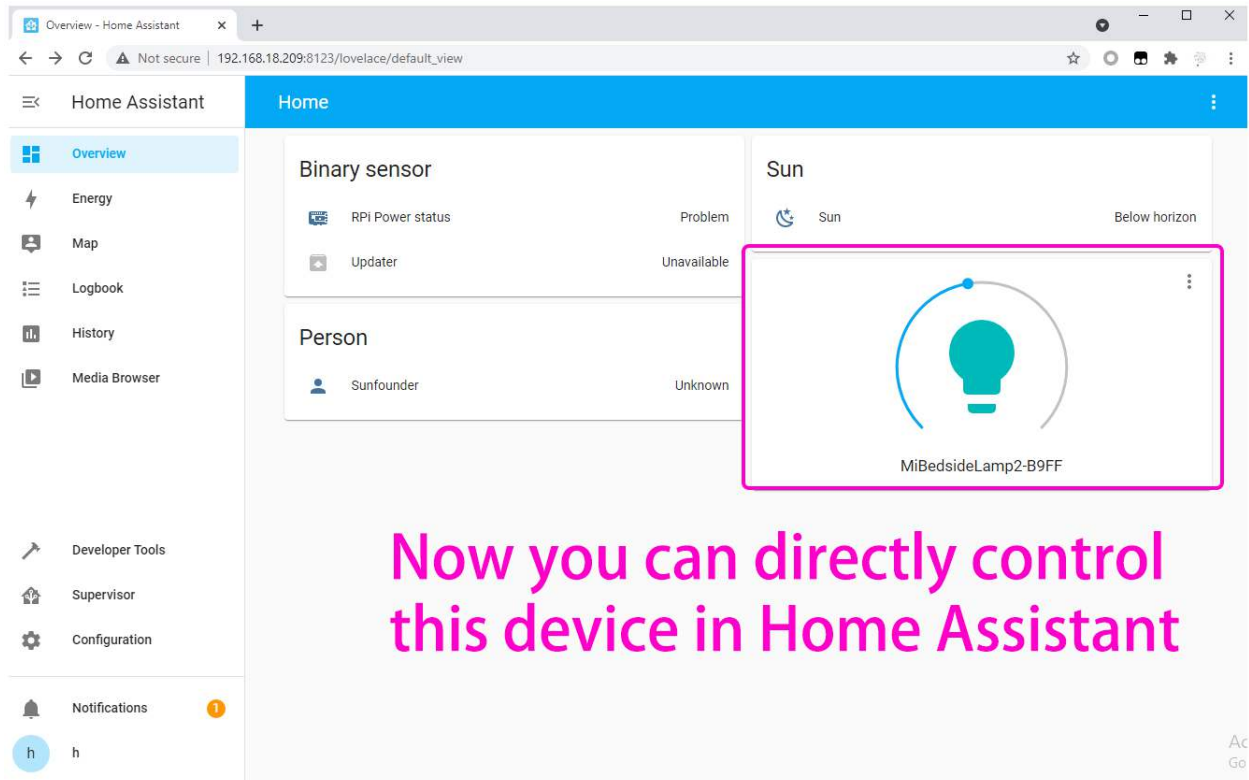

For more styles, you can refer to [Official Demo](#).

5.4.6 Start the Home Assistant Service at Boot

Normally, Docker is self-starting after booting by default, which also means that after you install Home Assistant, you can use it as long as you start the Raspberry Pi.

You can use the following command to view the boot list. The `docker.service` should be in the enabled state.

```
sudo systemctl list-unit-files | grep enable
```

To turn off Docker's self-startup, please enter the following command:

```
sudo systemctl disable docker.service
```

To enable Docker's self-startup, please enter the following command:

```
sudo systemctl enable docker.service
```

5.4.7 Enter the Home Assistant Page at Boot

Experience the full-screen self-boot interface first. Please close the already open Home Assistant URL and run `chromium-browser --start-fullscreen "http://localhost:8123"`.

If you want to automatically display the Home Assistant interface in full screen after booting, then do the following.

1. Go to the `autostart` folder.

```
cd /home/pi/.config/autostart/
```

Note: If the `autostart` folder does not exist, you need to create a new one.

```
sudo mkdir -p /home/pi/.config/autostart/
```

2. Create `chrome_start_fullscreen.desktop` file.

```
sudo nano chrome_start_fullscreen.desktop
```

3. Edit the `chrome_start_fullscreen.desktop` file as follows.

```
[Desktop Entry]
Type = Application
Exec = chromium-browser --start-fullscreen "http://localhost:8123"
```

Save and exit: `Ctrl + X, Y, Enter`.

Note: If you want to cancel the full-screen self-start, comment out the contents of the `.desktop` file (by “#”) and restart the Raspberry Pi.

```
cd /home/pi/.config/autostart/
sudo nano chrome_start_fullscreen.desktop
```

4. Exit full screen.

computer:

Method 1: Press F11.

Method 2: Move the mouse to the upper column of the screen and click the exit button that appears.

Method 3: Right-click the pop-up menu, select “Exit full screen”.

Touch screen:

Long press the blank space to pop up the menu, click the exit button at the top of the screen or select “Exit full screen”.

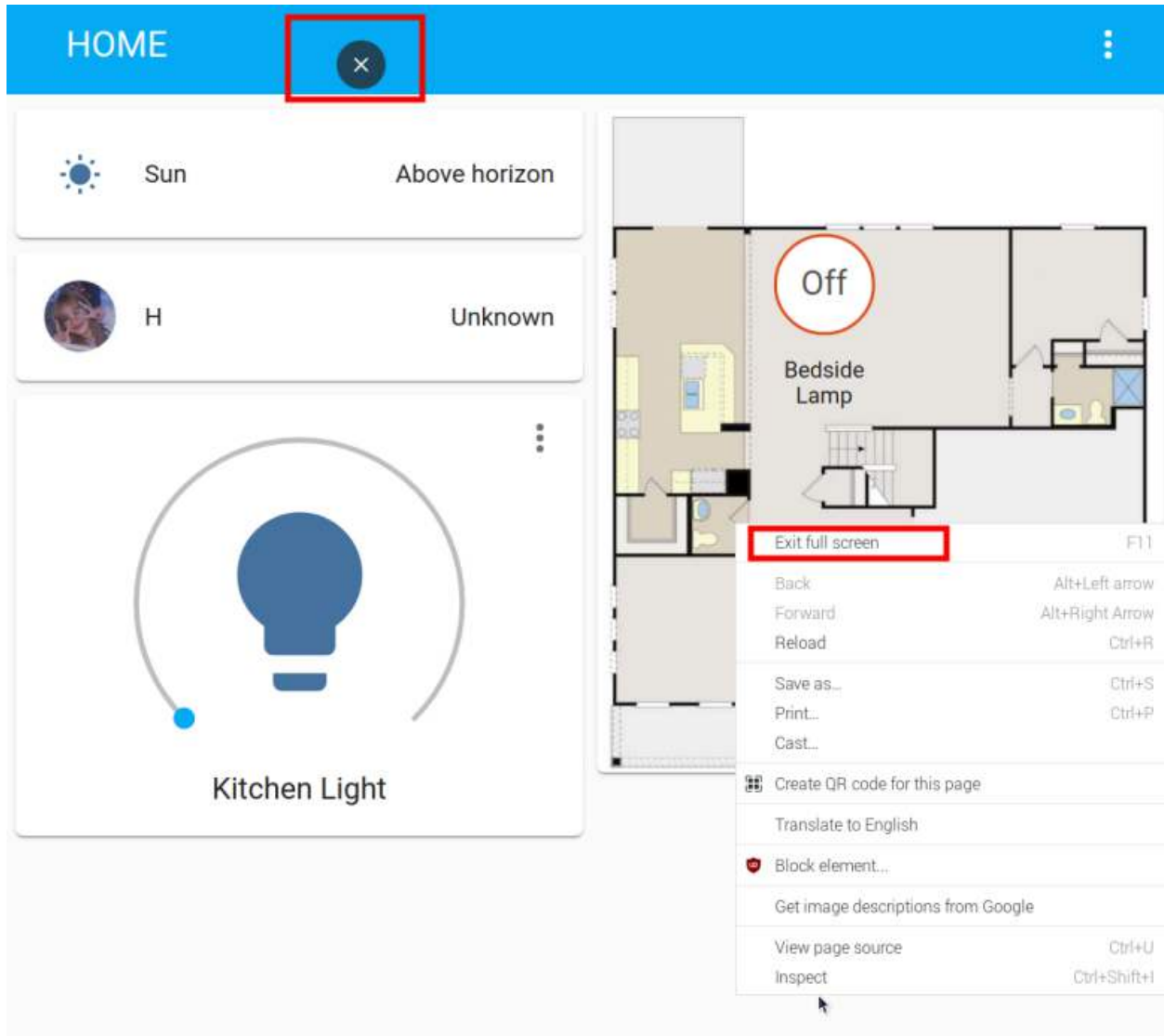

5.4.8 Home Assistant File Structure

Homeassistant creates a configuration file by default under the path of the executing user (created homeassistant) at the `~/.homeassistant` path.

The file directory structure is as follows:

```

Code
1 → .homeassistant tree -a -I 'deps'
2
3 |— .HA_VERSION
4 |— .cloud
5 |— .storage
6 |   |— auth
7 |   |— auth_provider.homeassistant
8 |   |— cloud
9 |   |— core.area_registry
10 |  |— core.config
11 |  |— core.config_entries
12 |  |— core.device_registry
13 |  |— core.entity_registry
14 |  |— core.restore_state
15 |  |— frontend.user_data_7a04118ad289497dbaf068d2b098b016
16 |  |— onboarding
17 |  |— person
18 |— automations.yaml
19 |— configuration.yaml
20 |— customize.yaml
21 |— groups.yaml
22 |— home-assistant.log
23 |— home-assistant_v2.db
24 |— home-assistant_v2.db-shm
25 |— home-assistant_v2.db-wal
26 |— scripts.yaml
27 |— secrets.yaml
28 |— tts
29
30 3 directories, 23 files

```

- `.storage` directory contains a lot of user-related information, including user login information (username/password, encrypted in `auth_provider.homeassistant` file).
- `configuration.yaml`: User-edited configuration files.
- `home-assistant.log`: Run log (cleared with each reboot).
- `home-assistant_v2.db`: Database..
- `.storage`: Various elements of front-end configuration.

5.5 IoT

In this article, we'll show you how to connect your Raspberry Pi to the **Blynk** platform to make some interesting IoT projects.

Blynk is a full suite of software required to prototype, deploy, and remotely manage connected electronic devices at any scale: from personal IoT projects to millions of commercial connected products. With Blynk anyone can connect their hardware to the cloud and build a no-code iOS, Android, and web applications to analyze real-time and historical data coming from devices, control them remotely from anywhere in the world, receive important notifications, and much more...

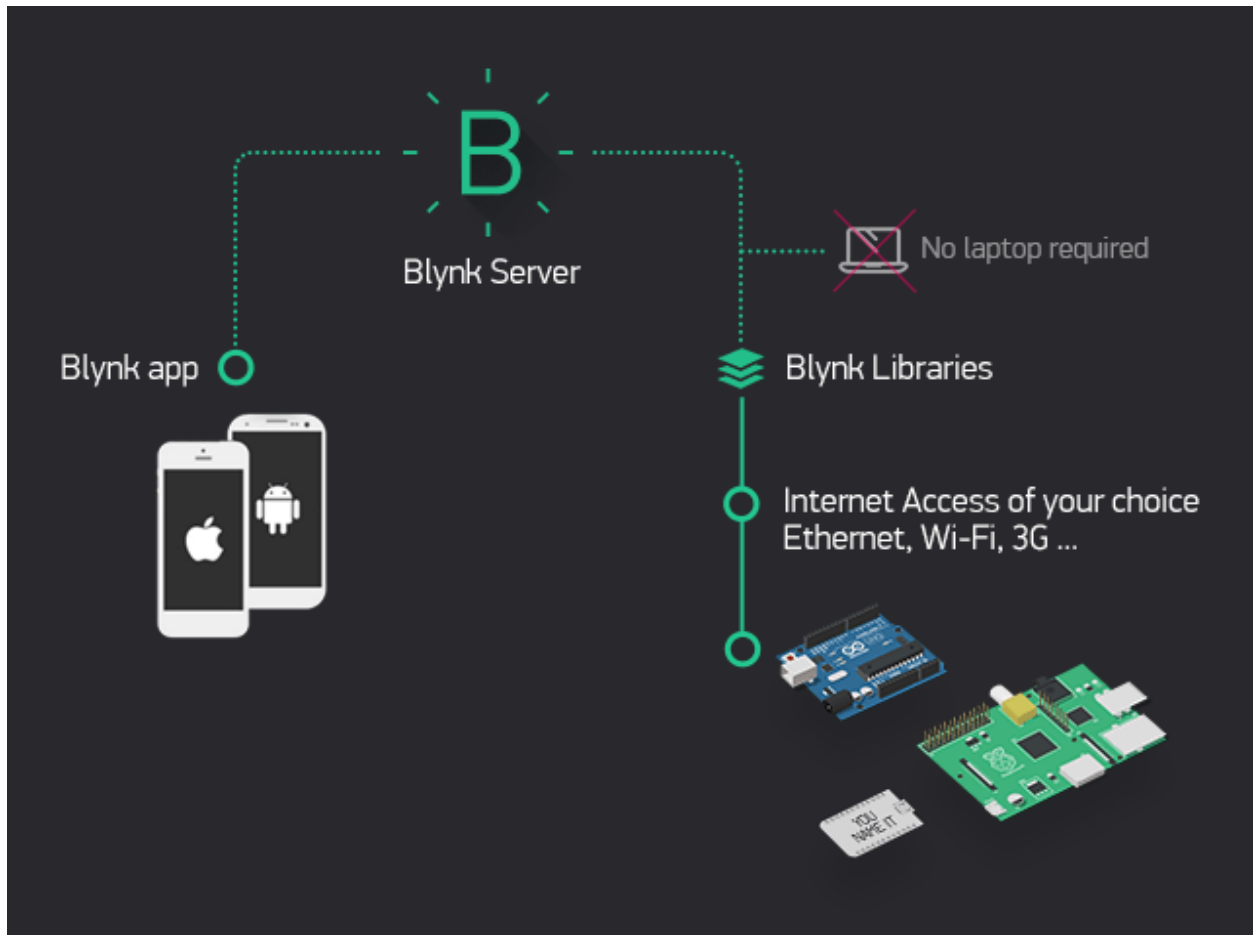

5.5.1 Get Start with Blynk

You will learn how to use Blynk in this project.

In the event that you trigger widgets on Blynk, your Raspberry Pi will print out their values.

Follow the steps below, and note that you must do them in order and not skip any chapters.

Note: Before starting this project, you have to bk_config.

1. Configuring the Blynk

1. Go to the [BLYNK](#) and click **START FREE**.

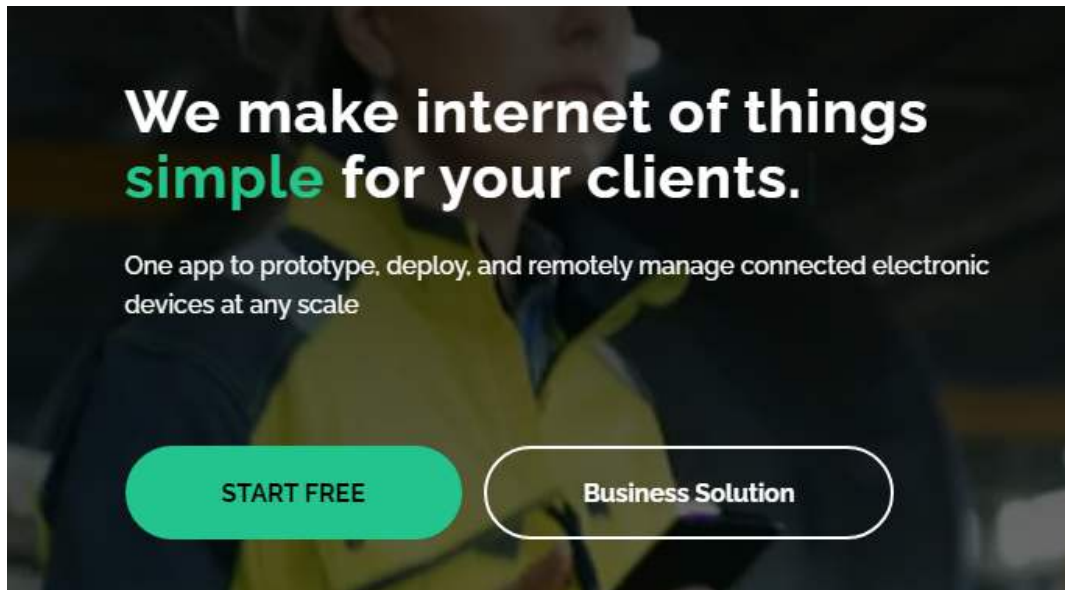

2. Fill in your email address to register an account.

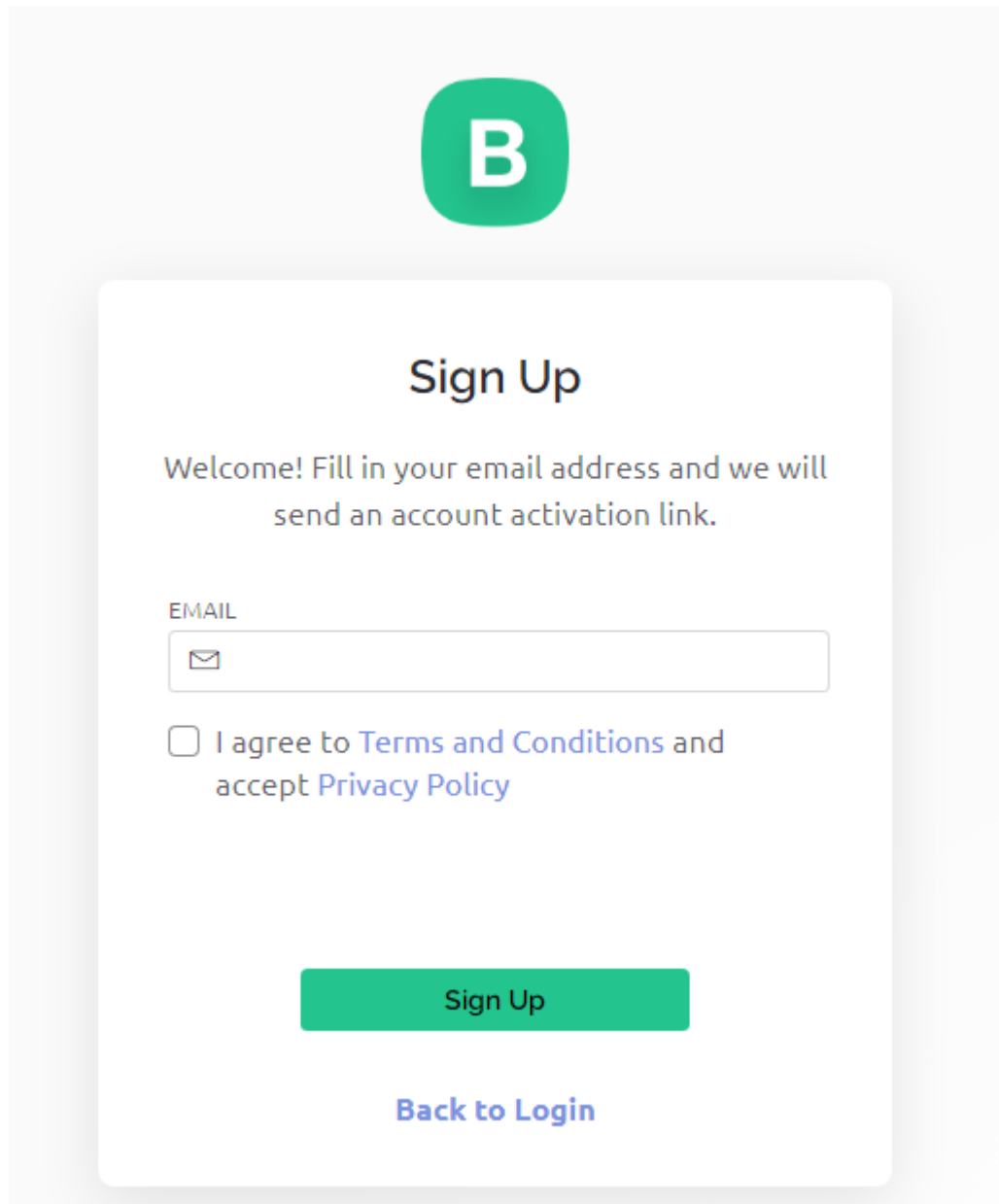
A screenshot of a mobile application's sign-up screen. At the top center is a green rounded square containing a white letter 'B'. Below this is a white rounded rectangle with a drop shadow. Inside the rectangle, the text 'Sign Up' is centered in a large, bold, black font. Underneath, a smaller black font reads 'Welcome! Fill in your email address and we will send an account activation link.' Below the text is a text input field with a light gray border and a small envelope icon on the left. Under the input field is a checkbox with the text 'I agree to Terms and Conditions and accept Privacy Policy'. The 'Terms and Conditions' and 'Privacy Policy' are in blue. At the bottom of the white rectangle is a green rounded rectangle with the text 'Sign Up' in white. Below the white rectangle, centered, is the text 'Back to Login' in blue.

B

Sign Up

Welcome! Fill in your email address and we will send an account activation link.

EMAIL

I agree to [Terms and Conditions](#) and accept [Privacy Policy](#)

Sign Up

[Back to Login](#)

3. Go to your email address to complete your account registration.



Welcome!

We're excited to see you on board.

To get started, you'll need to create a password for your account.

Create Password

The link will expire in 30 days.

4. Afterwards, **Blynk Tour** will appear and you can read it to learn the basic information about the Blynk.

Blynk Tour

1 Welcome 2 Platform 3 Modes 4 Devices 5 Template 6 Template components 7 Features 8 Business

Hi Blynker!

You've just joined the community of more than 500,000+ developers building amazing IoT products and projects.

With Blynk you can connect your devices to the Internet and create mobile and web dashboards to control your devices from anywhere in the world.

Let's save your learning time with a few quick steps.



Skip **Let's go!**

5. Next we need to create a template and device, click **Cancel**.

Quickstart

This is a step by step guide to get your first device online and start controlling it from anywhere in the world in **less than 5 minutes**

What you will need:

- Supported hardware. Check the full list of supported hardware [here](#).
- IDE. You can use Arduino IDE or PlatformIO or any other editor.
- Blynk Library
- It will be beneficial if you already know how to upload code to your hardware.

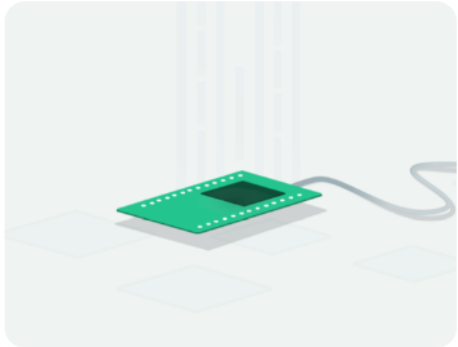

Cancel **Let's go!**

6. Go to Template from the navigation bar.

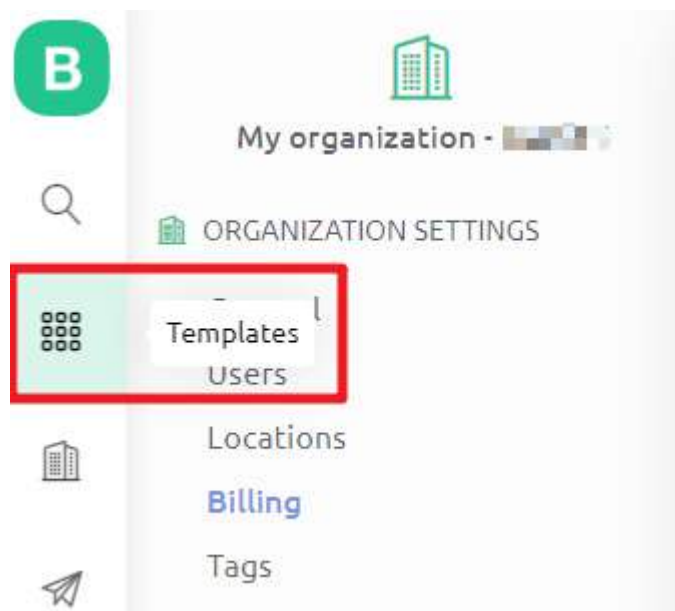

7. Create New Template

Start by creating your first template

Template is a digital model of a physical object. It is used in Blynk platform as a template to be assigned to devices.

[+ New Template](#)

8. Fill in **NAME**, feel free to do so; **HARDWARE** should be **Raspberry Pi**. Then **Done**.

Create New Template

NAME

HARDWARE CONNECTION TYPE

DESCRIPTION

19 / 128

9. You will be redirected to the Info page, just click on save in the top right corner.

10. Go to **Search** page from the navigation bar.

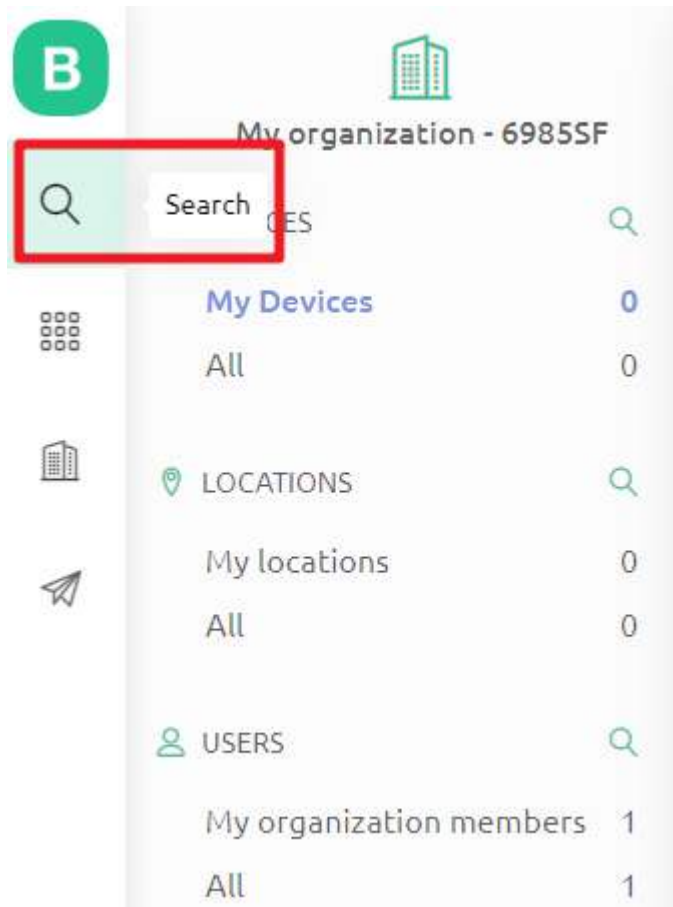

11. Create New Device.

All of your devices will be here.

You can activate new devices by using
your app for IOS or Android



Download for IOS



Download for Android

+ New Device

12. From template.

New Device

Choose a way to create new device

From template

Scan QR code

Manual entry

+ Create a device by filling in a simple form

Cancel

13. Select **TEMPLATE** as the one you just set, **DEVICE NAME** can be customized. Then click Create.

New Device

Create new device by filling in the form below

TEMPLATE

My Template

DEVICE NAME

My Device

Cancel Create

14. You should now see a page like this one, which means that your initial Blynk setup is complete.

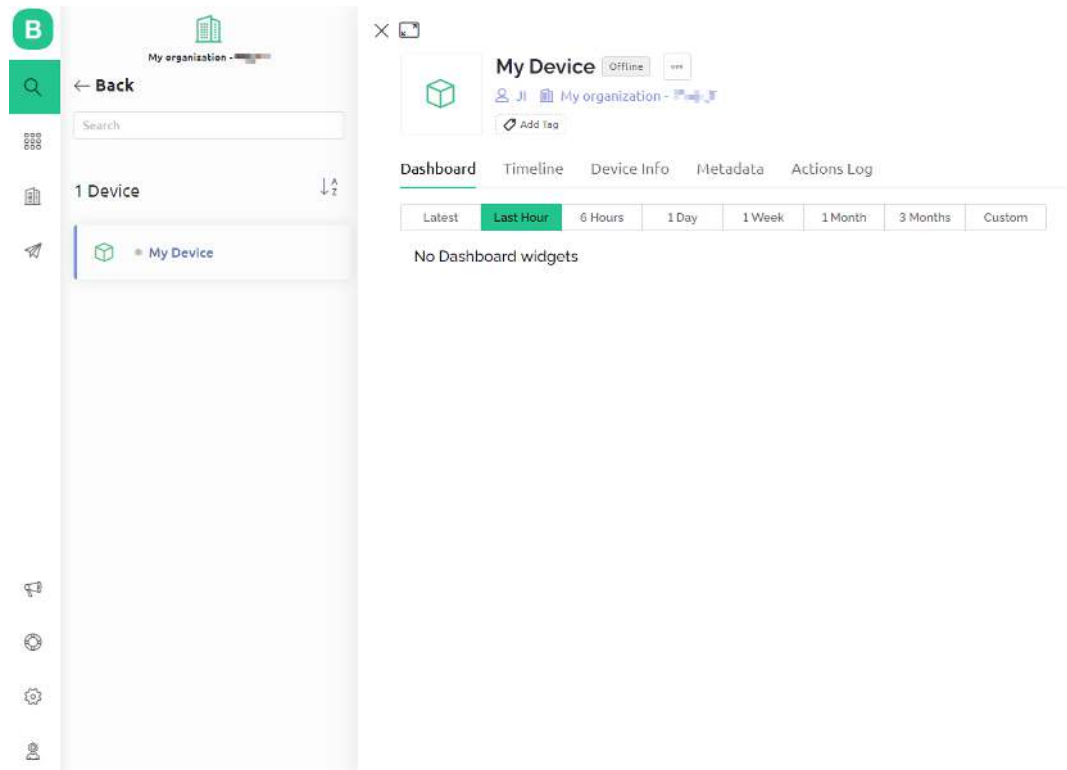

2. Edit Dashboard

1. Click on the menu icon in the upper right corner and select edit dashboard.

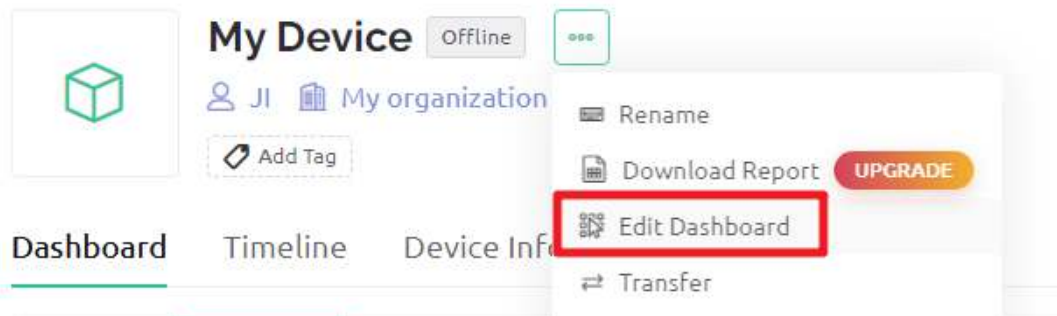

2. Then drag any CONTROL Widgets you want onto the Dashboard. I dragged a Switch and a Slider.

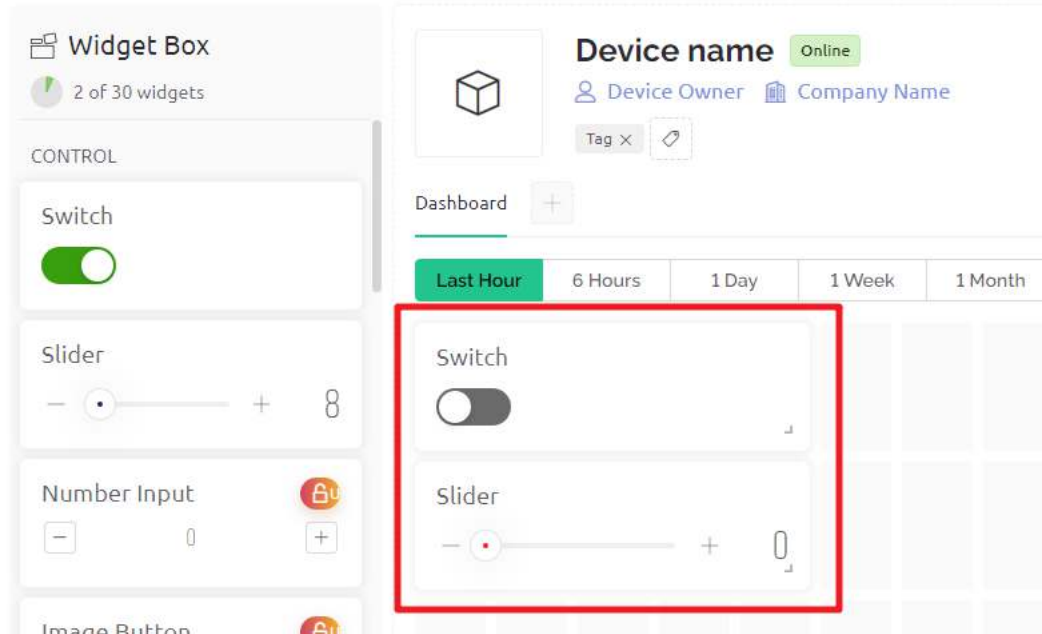

3. Tap the setting icon on the widget.

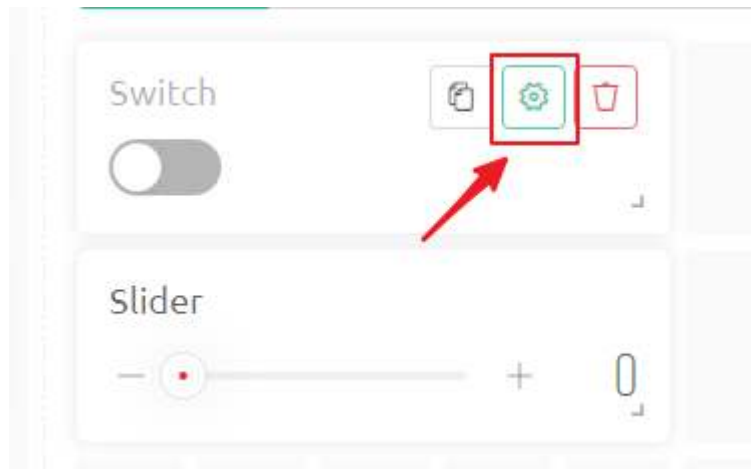

4. Create Datastream, select Virtual Pin

TITLE (OPTIONAL)

Switch

Datastream

You have no datastreams to select

[+ Create Datastream](#)

Digital

Virtual Pin

Enumerable



5. Complete the datastream setup. Here is the datastream created for Switch, so **DATA TYPE** select *Integer*, **MIN** and **MAX** set to 0 and 1. Create and then Save.

Switch Settings i

TITLE (OPTIONAL)

Datastream

Virtual Pin Datastream

NAME



ALIAS



PIN

DATA TYPE

UNITS

MIN

MAX

DEFAULT VALUE

 ADVANCED SETTINGS

- Use the same steps to create a Datastream for the slider widget, and again, modify **DATA TYPE**, **MIN** and **MAX** to what you need.

Slider Settings i

TITLE (OPTIONAL)

Datastream

Virtual Pin Datastream

NAME	<input type="text" value="Slider V1"/>	ALIAS	<input type="text" value="Slider V1"/>	<input type="checkbox"/>	
PIN	<input type="text" value="V1"/>	DATA TYPE	<input type="text" value="Integer"/>		
UNITS	<input type="text" value="None"/>				
MIN	<input type="text" value="0"/>	MAX	<input type="text" value="10"/>	DEFAULT VALUE	<input type="text" value="5"/>

ADVANCED SETTINGS

7. When finished, click Save And Apply at the top right.

3. Install the Blynk library

Run the following command to install.

```
cd /home/pi
git clone https://github.com/vshymanskyi/blynk-library-python.git
cd blynk-library-python
sudo python3 setup.py
```

4. Download the Example

We have provided some examples, please run the following command to download them.

```
cd /home/pi
git clone https://github.com/sunfounder/blynk-raspberrypi-python.git
```

5. Run the Code

1. Go to Blynk's Device Info page, you will see some information under **FIRMWARE CONFIGURATION**, you need to copy **BLYNK_AUTH_TOKEN** down.

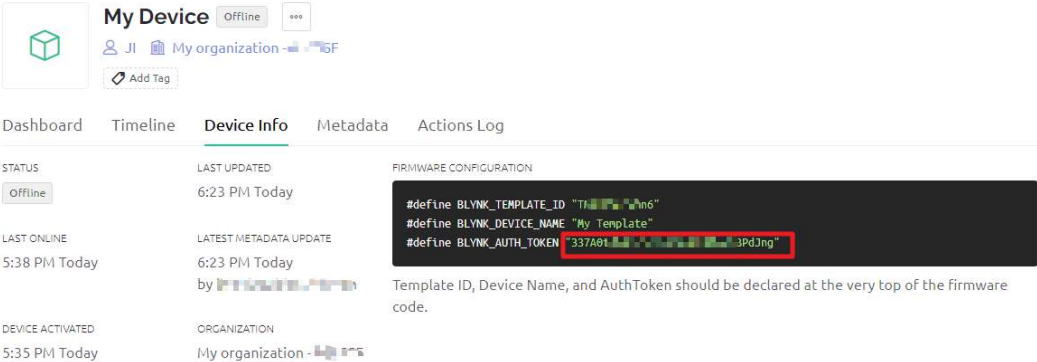

The screenshot shows the Blynk web interface for a device named 'My Device'. The 'Device Info' tab is selected, displaying various status metrics and a 'FIRMWARE CONFIGURATION' section. The configuration code is shown in a dark box with a red box highlighting the BLYNK_AUTH_TOKEN value: '#define BLYNK_AUTH_TOKEN "337A01...3pdJng"'. Below the code, a note states: 'Template ID, Device Name, and AuthToken should be declared at the very top of the firmware code.'

2. Edit the code.

```
cd /home/pi/blynk-raspberrypi-python
sudo nano blynk_start.py
```

3. Find the line below and past your BLYNK_AUTH_TOKEN.

```
BLYNK_AUTH = 'YourAuthToken'
```

4. Run the code.

```
sudo python3 blynk_start.py
```

5. Go to Blynk, and operate the widget on Dashboard.

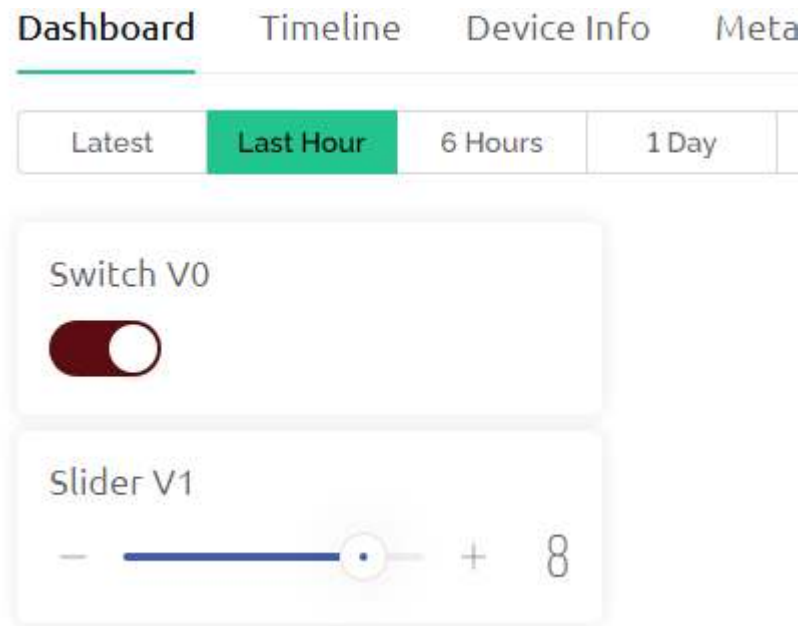

6. Now you will be able to see your actions on the terminal.

```
..
  / _ ) / / _ _ _ _ / / / _
 / _ / / / / / _ \ / ' /
 / ___ / \ \ , / _ / \ \ \
      / ___ / for Python v1.0.0 (linux)

Connecting to blynk.cloud:443...
Blynk ready. Ping: 142 ms
V0 value: ['1']
V0 value: ['0']
V1 value: ['3']
V1 value: ['8']
V0 value: ['1']
```

5.5.2 Smart Light

In this project, we use Blynk's Slider to control the brightness of the LED, turning it on and off with Switch.

Note: Before starting this project, we recommend that you complete *Get Start with Blynk*. The following will give you a clear understanding of Blynk.

1. Wiring

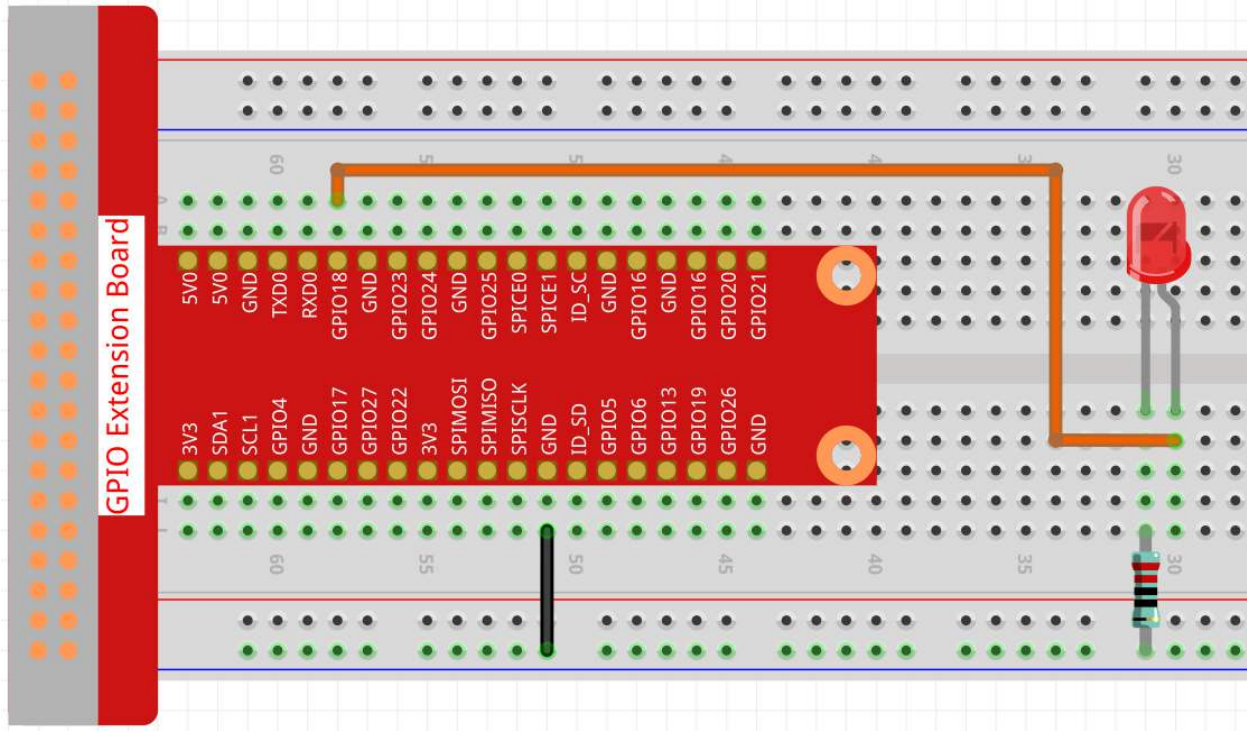

2. Create Widget and Datastream

1. Click on the menu icon in the upper right corner and select edit dashboard.

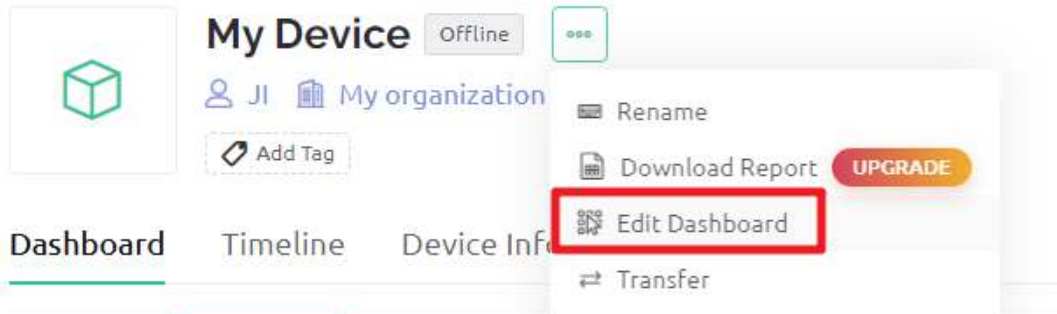

2. Add a Switch widget and a Slider widget to the Dashboard.

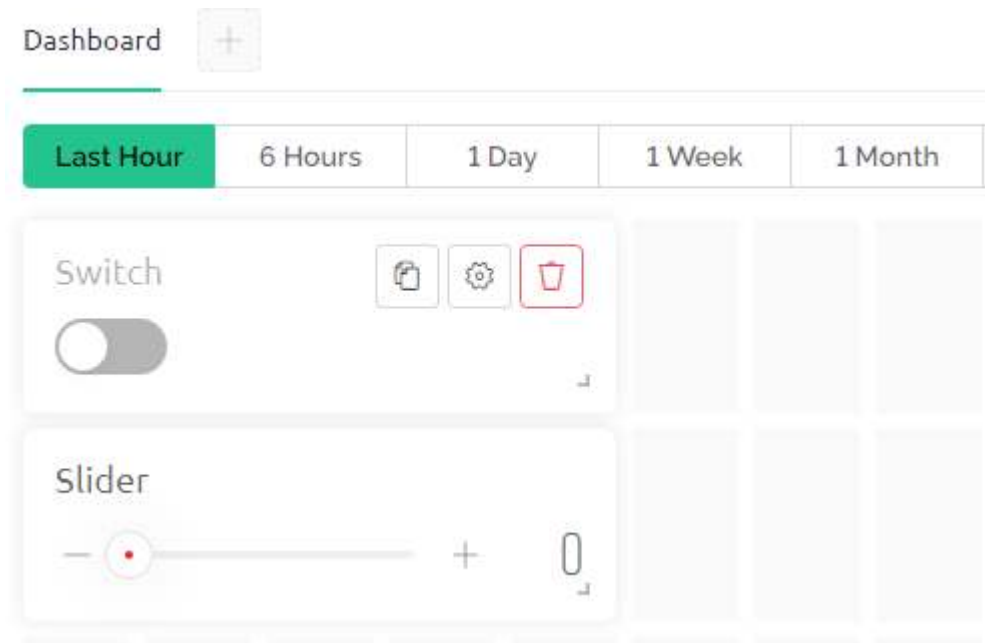

3. Create a Datastream for the Switch widget (I used V3). It will be used to control the turning on and off of the LED.

Switch Settings ?

TITLE (OPTIONAL)

Switch V3

Datastream

Virtual Pin Datastream

NAME	ALIAS	
 Integer V3	Integer V3	<input checked="" type="checkbox"/>

PIN	DATA TYPE
V3	Integer

UNITS

None

MIN	MAX	DEFAULT VALUE
0	1	0

ADVANCED SETTINGS

4. Create a Datastream for the Slider widget (I used V2), its value range is 0 to 100, it will be used to control the brightness of the LED.

Slider Settings ●

TITLE (OPTIONAL)

Slider V2

Datastream

Virtual Pin Datastream

NAME	<input type="text" value="Slider V2"/>	ALIAS	<input type="text" value="Slider V2"/>	<input checked="" type="checkbox"/>
PIN	<input type="text" value="V2"/>	DATA TYPE	<input type="text" value="Integer"/>	
UNITS	<input type="text" value="None"/>			
MIN	MAX	DEFAULT VALUE		
<input type="text" value="0"/>	<input type="text" value="100"/>	<input type="text" value="0"/>		

ADVANCED SETTINGS

5. When finished, click Save And Apply at the top right.



3. Run the Code

1. Edit the code

7-inch DIY Touch Screen

```
cd /home/pi/blynk-raspberrypi-python
sudo nano blynk_light.py
```

2. Find the line below and past your BLYNK_AUTH_TOKEN.

```
BLYNK_AUTH = 'YourAuthToken'
```

3. Run the code.

```
sudo python3 blynk_light.py
```

4. Go to Blynk, operate widget on Dashboard. now you click switch widget will turn on/off LED. slide Slider widget will change LED brightness.

5.5.3 Door Window Sensor

When you're outside, you've probably had this confusion. "Are the doors and windows of my house closed?"

To solve this problem, in this project, we will build a door and window sensor with Reed Switch and magnets.

Install this sensor and magnet on both sides of the door or window. You will be able to check whether your doors and windows are closed or not from the Blynk APP on your phone.

Note: Before starting this project, we recommend that you complete *Get Start with Blynk*. The following will give you a clear understanding of Blynk.

1. Wiring

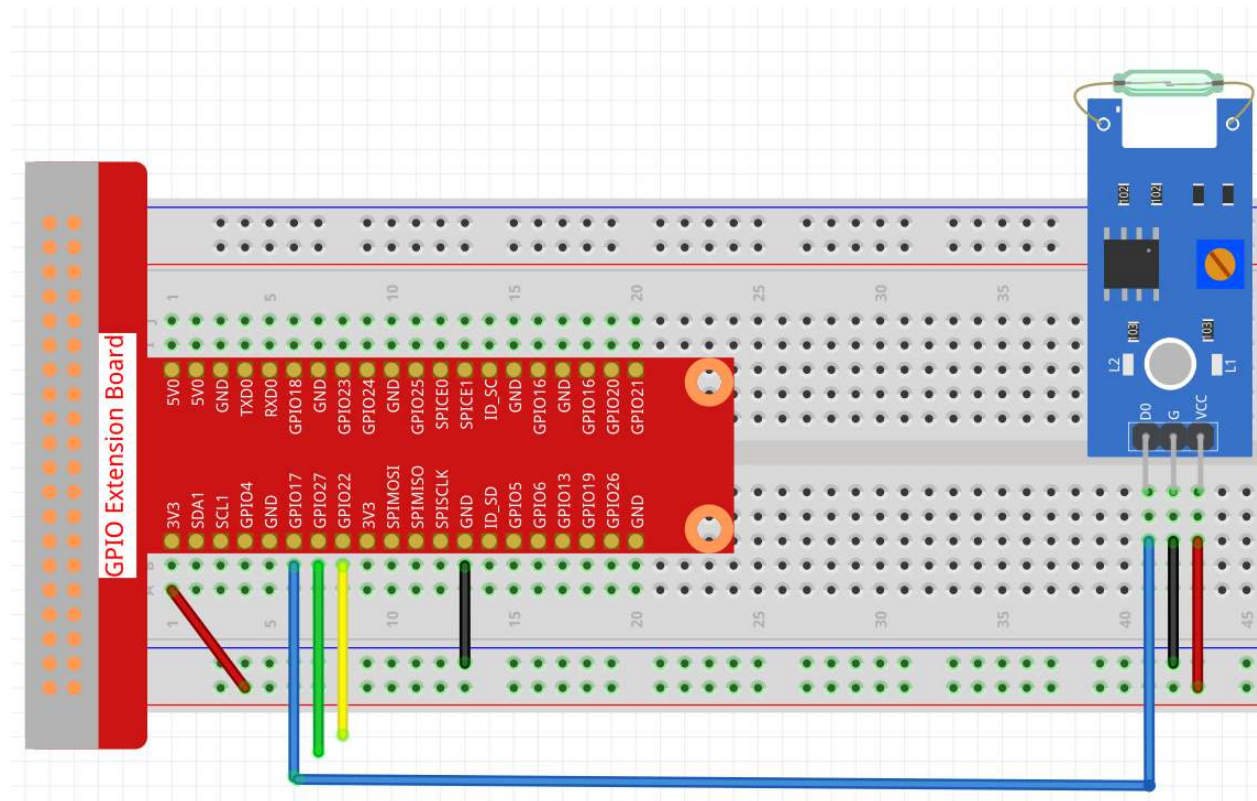

2. Create Datastream

1. Click on the menu icon in the upper right corner and select edit dashboard.

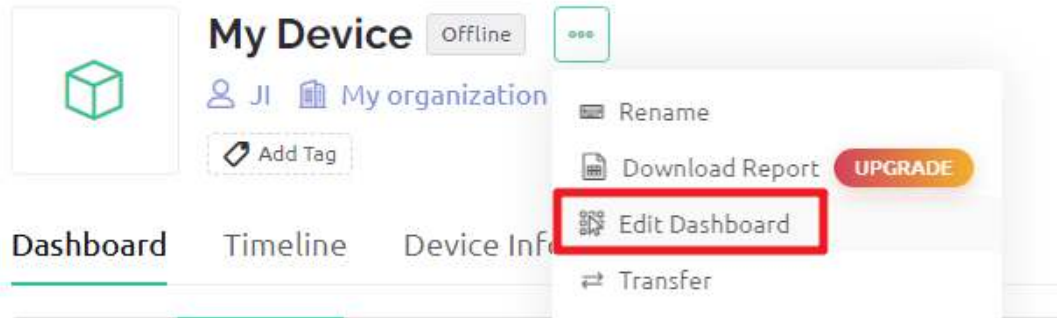

2. Go to the Datastreams page and create a New Datastream.

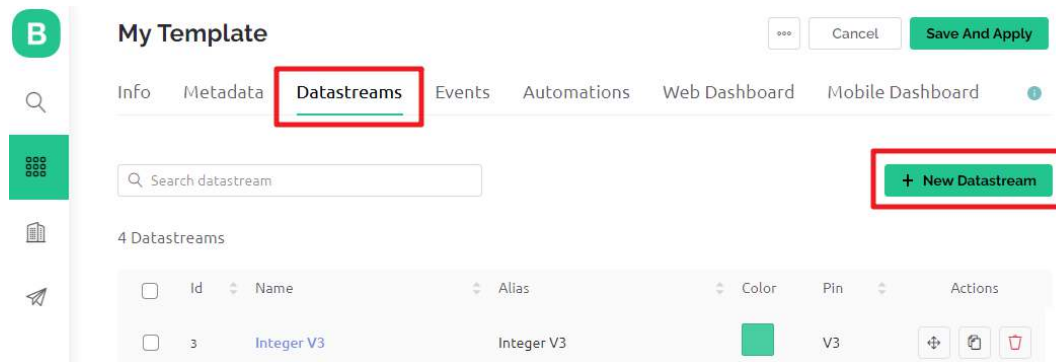

3. Create a Virtual Pin V4.

Virtual Pin Datastream

NAME	ALIAS	
<input type="text" value="Reed V4"/>	<input type="text" value="Reed V4"/>	
PIN	DATA TYPE	
<input type="text" value="V4"/>	<input type="text" value="Integer"/>	
UNITS		
<input type="text" value="None"/>		
MIN	MAX	DEFAULT VALUE
<input type="text" value="0"/>	<input type="text" value="1"/>	<input type="text" value="0"/>

ADVANCED SETTINGS

- When finished, click Save And Apply at the top right.

3. Run the Code

- Edit the code

```
cd /home/pi/blynk-raspberrypi-python
sudo nano blynk_reed.py
```

- Find the line below and past your BLYNK_AUTH_TOKEN.

```
BLYNK_AUTH = 'YourAuthToken'
```

- Run the code.

```
sudo python3 blynk_reed.py
```

4. Open Blynk APP

Note: As datastreams can only be created in Blynk on the web, you will need to reference different projects to create datastreams on the web, then follow the tutorial below to create widgets in Blynk on your mobile device.

- Open Google Play or APP Store on your mobile device and search for “Blynk IoT” (not Blynk(legacy)) to download.

2. After opening the APP, login in, this account should be the same as the account used on the web client.
3. Then go to **Dashboard** (if you don't have one, create one) and you will see that the **Dashboard** for mobile and web are independent of each other.

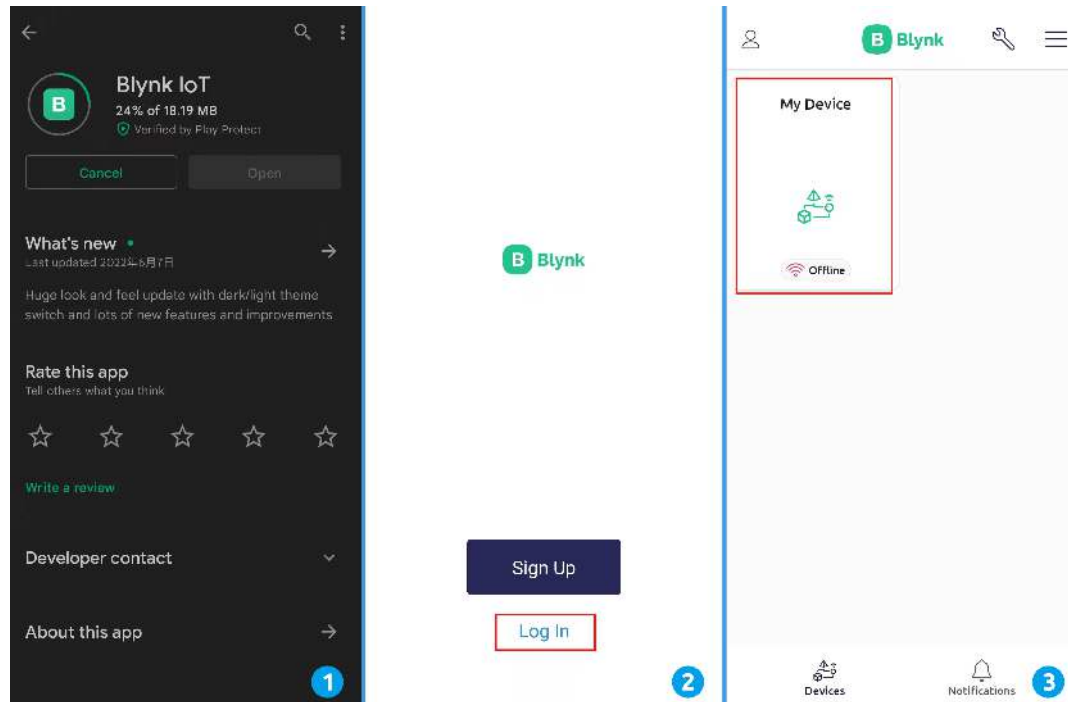

4. Click **Edit Icon**.
5. Click on the blank area.
6. Choose **LED** widget.

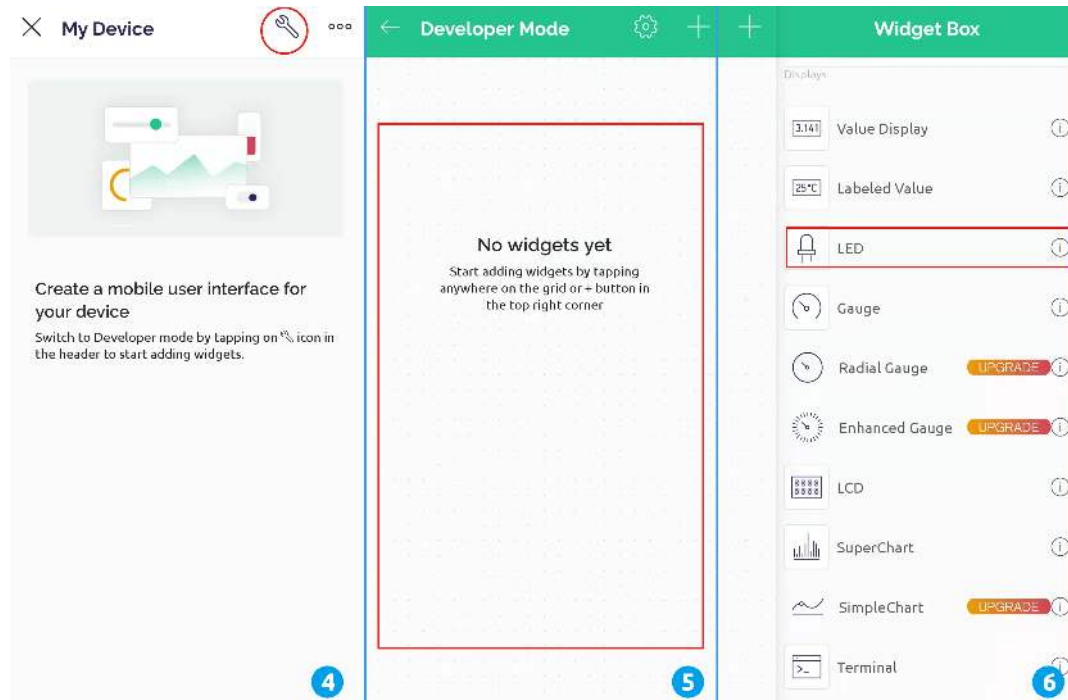

7. Now you will see a **LED** widget appear in the blank area, even if it looks like a blank grid, click on it.
8. **LED** Settings will appear, select the **V4** datastreams you just set in the web page. Note that each widget corresponds to a different datastream in each project.
9. Go back to the **Dashboard** page. Now if you see that the **LED** widget is filled with color, your door or window is open; if the **LED** widget is not filled with color, the door or window is closed.

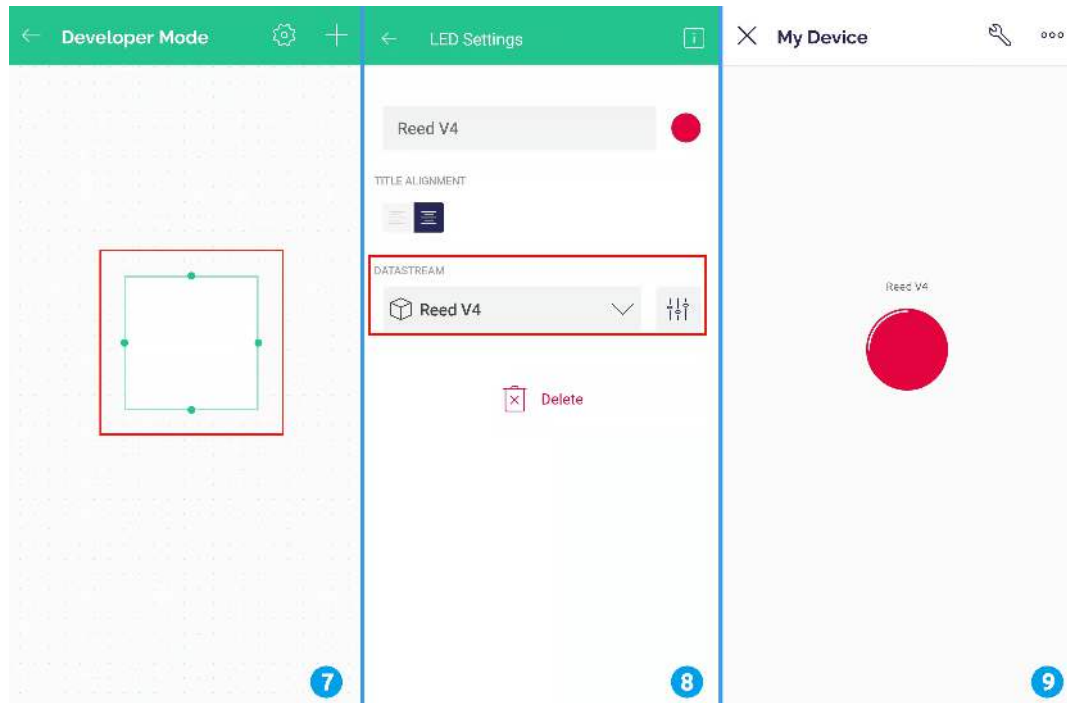

5.5.4 Smart Fan

In this project, you can see the temperature from Blynk and turn on the fan remotely.

Note: Before starting this project, we recommend that you complete *Get Start with Blynk*. The following will give you a clear understanding of Blynk.

1. Wiring

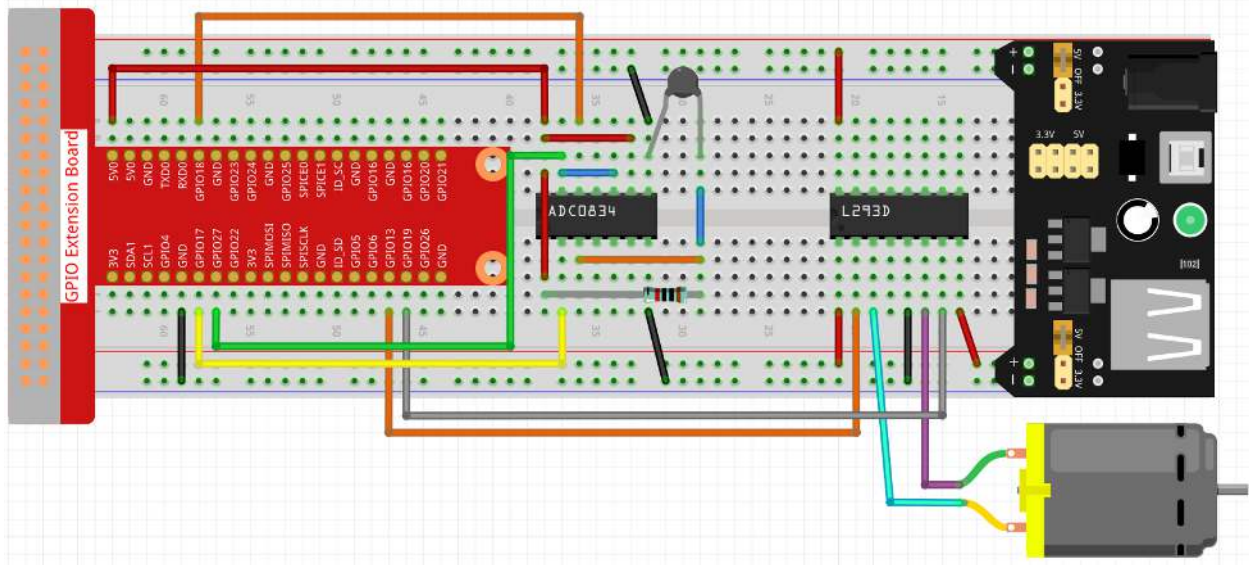

2. Create Widget and Datastream

1. Click on the menu icon in the upper right corner and select edit dashboard.

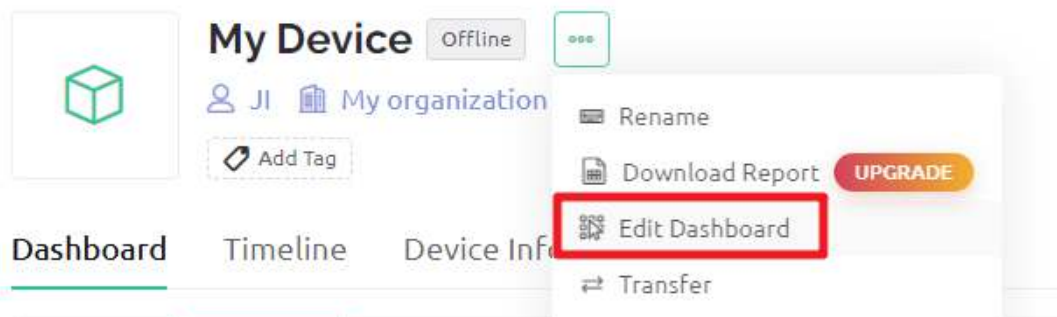

2. Add a Switch widget and a Label widget to the Dashboard.

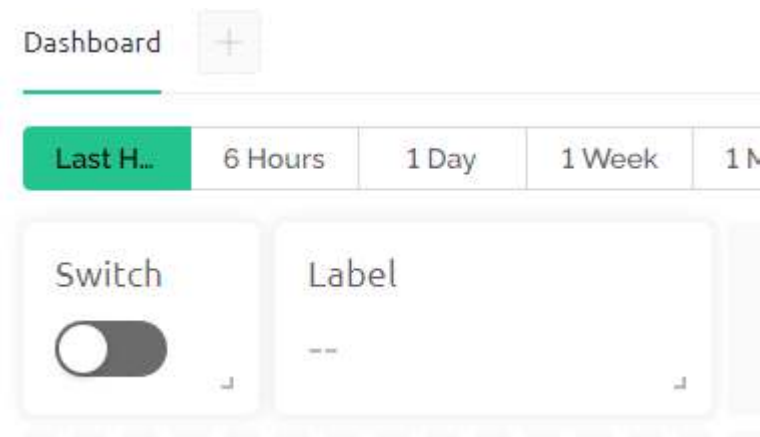

3. Create a Datastream (I used V3) for the Switch widget. It will be used to turn on the Motor.

Switch Settings ?

TITLE (OPTIONAL)

Datastream

Virtual Pin Datastream

NAME	ALIAS
<input type="text" value="Integer V3"/>	<input type="text" value="Integer V3"/>

PIN	DATA TYPE
<input type="text" value="V3"/>	<input type="text" value="Integer"/>

UNITS
<input type="text" value="None"/>

MIN	MAX	DEFAULT VALUE
<input type="text" value="0"/>	<input type="text" value="1"/>	<input type="text" value="0"/>

 ADVANCED SETTINGS

4. Create a Datastream for the Label widget(I used V0). It will be used to display the temperature. Set **DATA TYPE** to String.

Label Settings ?

TITLE (OPTIONAL)

Datastream

Virtual Pin Datastream

NAME



ALIAS



PIN

DATA TYPE

DEFAULT VALUE

+ ADVANCED SETTINGS

- When finished, click Save And Apply at the top right.



3. Run the Code

- Edit the code

```
cd /home/pi/blynk-raspberrypi-python
sudo nano blynk_motor.py
```

- Find the line below and past your BLYNK_AUTH_TOKEN.

```
BLYNK_AUTH = 'YourAuthToken'
```

3. Run the code.

```
sudo python3 blynk_motor.py
```

4. Go to Blynk, on the Dashboard you can check the temperature via Label widget; you can turn on/off the fan via Switch widget.

5.5.5 Temperature Recorder

In this project, you can see the current temperature and the temperature change line graph from Blynk.

Note: Before starting this project, we recommend that you complete *Get Start with Blynk*. The following will give you a clear understanding of Blynk.

1. Wiring

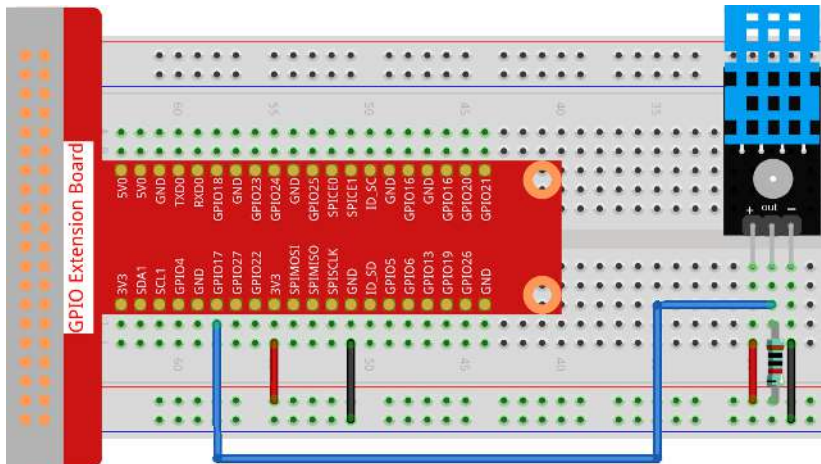

2. Create Widget and Datastream

1. Click on the menu icon in the upper right corner and select edit dashboard.

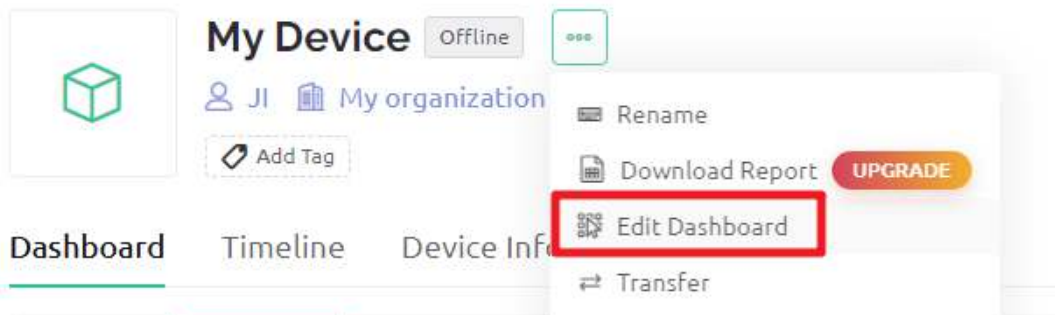

2. Add a Gauge widget and a Chart widget to the Dashboard.

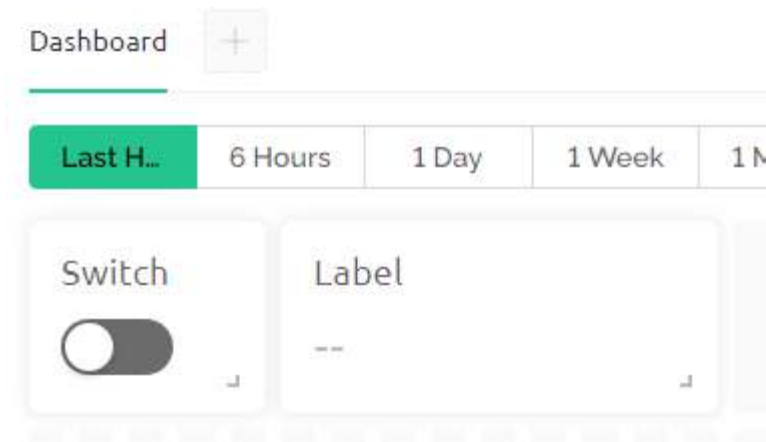

3. Create a Datastream for the Gauge widget (I used V5). It will be used to display the temperature. Set **DATA TYPE** to `Double`, **DECIMALS** to `#. #` (two valid decimal places).

Gauge Settings

TITLE (OPTIONAL)

Temperature

Datastream

Virtual Pin Datastream

NAME



Temp V5

ALIAS

Temp V5



PIN

V5

DATA TYPE

Double

UNITS

None

MIN

0

MAX

100

DECIMALS

##

DEFAULT VALUE

Default Va...

ADVANCED SETTINGS

Cancel

Create

4. Add the V5 Datastream you just created to the Chart widget.

Chart Settings

TITLE (OPTIONAL)
Chart

Datastreams
UPGRADE to add more datastreams

Temp VS (V5) AVG of

CHART TYPE
 Line
 Bar
 Pie
 Area

COLOR
 Blue

Y-AXIS
 Show Y-axis
 Autoscale

MINIMUM Y AXIS RANGE
 Minimum Y axis range

Enable Zoom
 Show legend

Chart (V5)
 • Temp VS
 100
 50
 0
 LTS
 • Temp VS: 22.6

Cancel Save

- When finished, click Save And Apply at the top right.



3. Run the Code

- Edit the code

```
cd /home/pi/blynk-raspberrypi-python
sudo nano blynk_temp.py
```

- Find the line below and past your BLYNK_AUTH_TOKEN.

```
BLYNK_AUTH = 'YourAuthToken'
```

- Run the code.

```
sudo python3 blynk_temp.py
```

- Go to Blynk. Now you can view the temperature and temperature change line graph on the Dashboard.

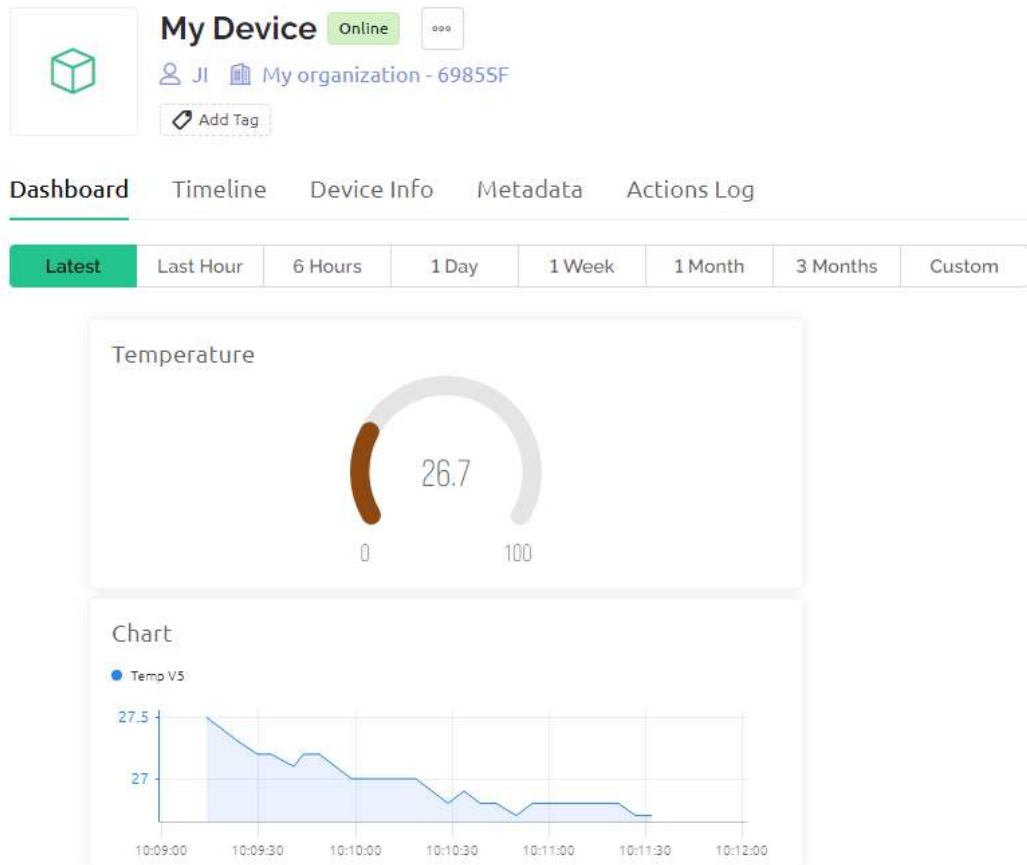

5.6 GPIO Programming

You can do some interesting projects by leading the Raspberry Pi pins out through a 40pin cable.

Note: Refer to *GPIO Extension Board* instructions for extending the 40 pins of the Raspberry Pi to a breadboard.

SunFounder has a very complete course system about Raspberry Pi GPIO learning kits, such as the following two learning kits.

- *Electronic Kit for Raspberry Pi and Arduino*

This basic learning kit is suitable for the Raspberry Pi and Arduino novice. This kit teaches basic circuit design and introduces Python programming for beginners.

- *Da Vinci Kit for Raspberry Pi*

This is an advanced Raspberry Pi teaching kit that contains a robust array of components. This kit teaches physical computing and Python programming principles for beginners and advanced users.

5.6.1 Electronic Kit for Raspberry Pi and Arduino

Tutorial Link

<https://docs.sunfounder.com/projects/electronic-kit/en/latest/index.html>

Product Link

Global: <https://www.sunfounder.com/products/electronics-fun-kit>

United States: <https://www.amazon.com/dp/product/B07QT78FXF>

Germany: <https://www.amazon.de/dp/B07QT78FXF>

Canada: <https://www.amazon.ca/dp/product/B07RQ7Z6G4>

5.6.2 Da Vinci Kit for Raspberry Pi

Tutorial Link

<https://docs.sunfounder.com/projects/davinci-kit-for-raspberry-pi/en/latest/>

Product Link

Global: <https://www.sunfounder.com/products/sunfounder-davinci-kit>

United States: <https://www.amazon.com/dp/product/B07WV2HYC6>

Japan: <https://www.amazon.co.jp/dp/product/B083SJQXCL>

Canada: <https://www.amazon.de/dp/B07WYX8M76>

Germany: <https://www.amazon.ca/dp/product/B07KH2C215>

5.7 Scratch Projects

In this chapter, you will learn to use Scratch on this screen, which includes 10 examples.

If you are a user who has just used Scratch, we recommend that you try the teaching examples in order so that you can quickly get started with Scratch.

If the Raspberry Pi system you downloaded comes with recommended software, you can find Scratch 3 in **Programming**.

If you download a system with only a desktop, you can click **Preferences** -> **Recommended Software** -> **Programming** to install the Scratch 3.

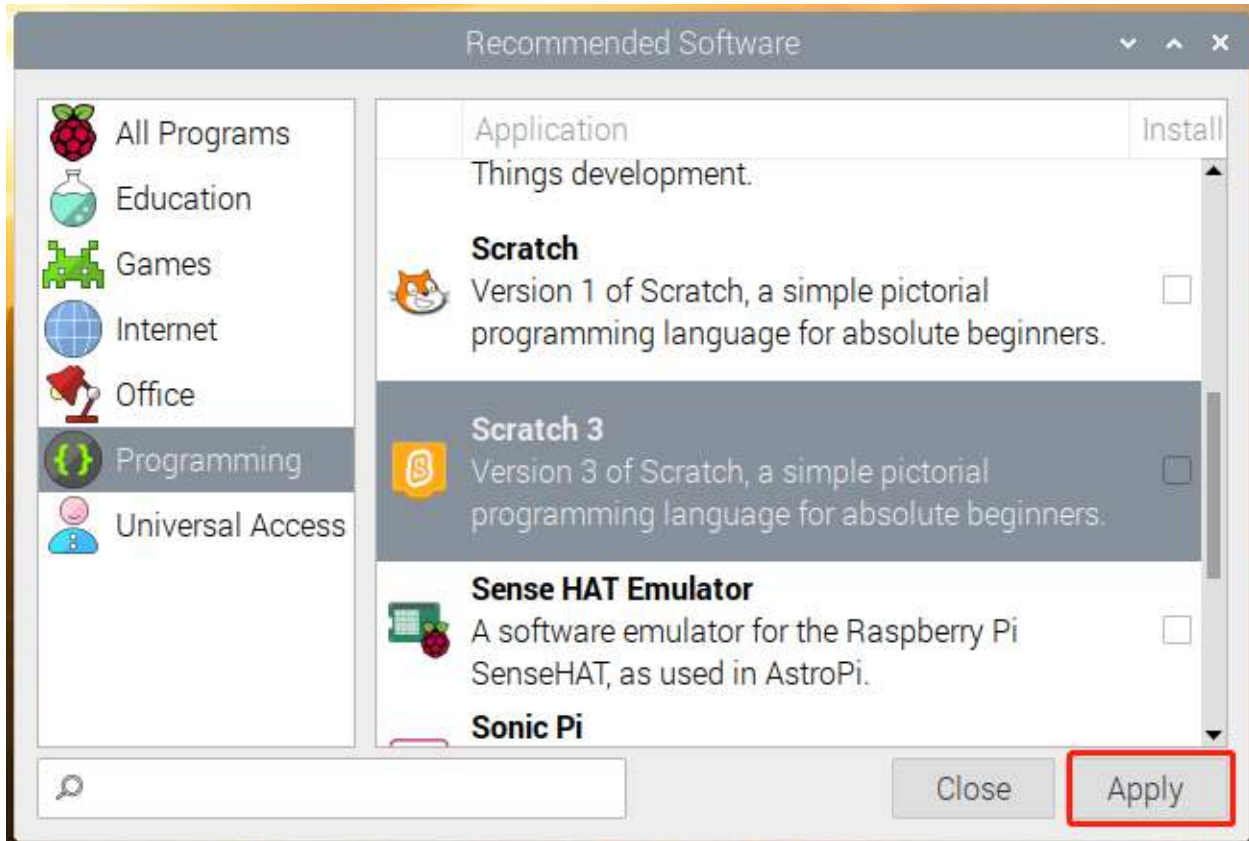

Note: Before trying the teaching examples, you should have downloaded the relevant materials and code files. Open a Terminal and enter the following command to download them from github.

```
git clone https://github.com/sunfounder/7-diy-touch-screen
```

Projects

5.7.1 Animate A Name

Description

Today we will learn to write our name on Scratch. When we click on the letters in the name, they will become active. Click the green flag to start.

Or click [Animate A Name](#), and then learn online tutorial on the Scratch official website.

Required Components

- A Screen
- Scratch 3 (either online or offline)

You Will Learn

- Choose the sprite you want.
- Program different sprites separately.
- Make the sprite change color.
- Let the sprite spin.
- Let the sprite zoom.
- Let the sprite flash.

Lesson Guide

My Name is Abby.

In the lower right corner of Scratch, there are two areas. We can add the sprite and backdrop we want here.

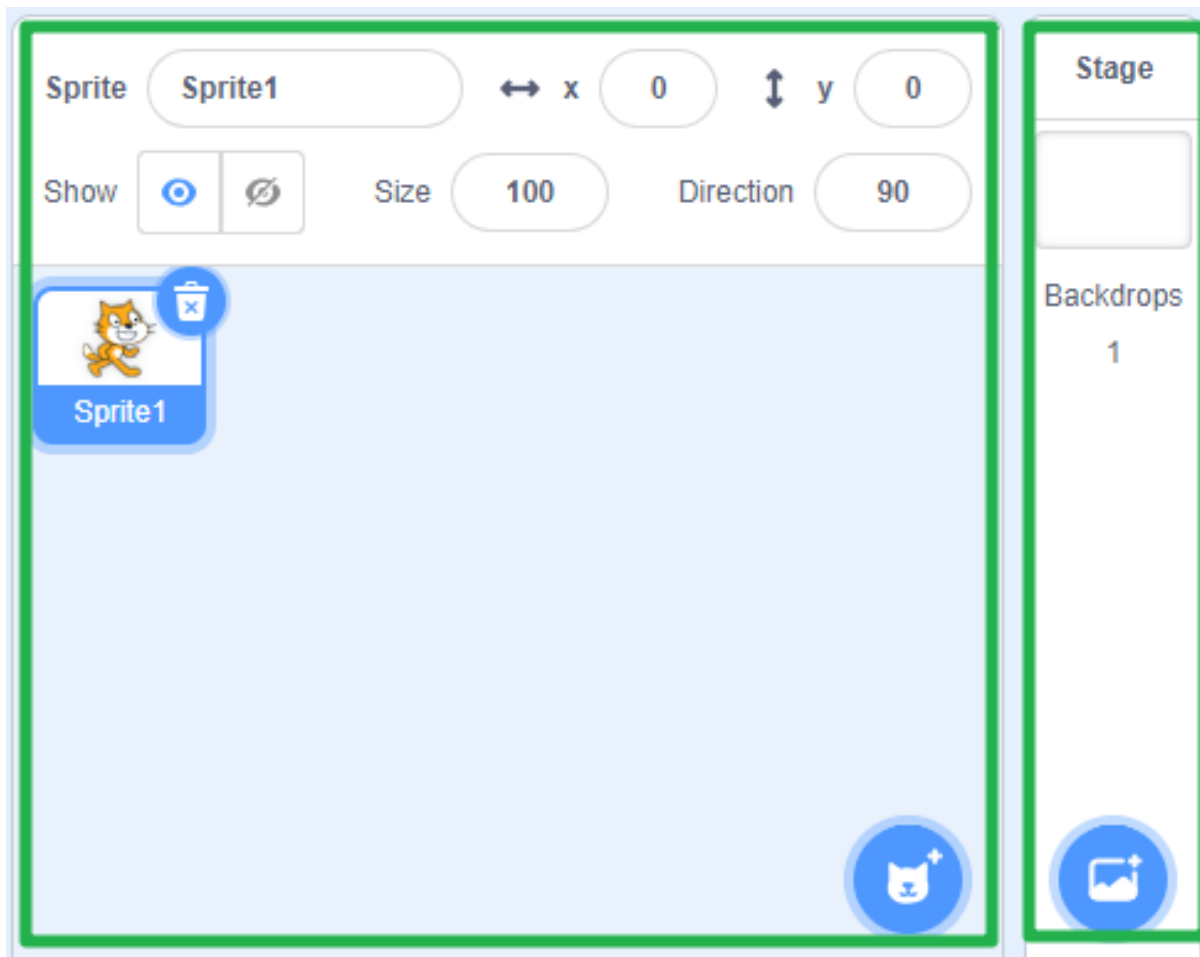

First delete the original sprite, we don't need it.

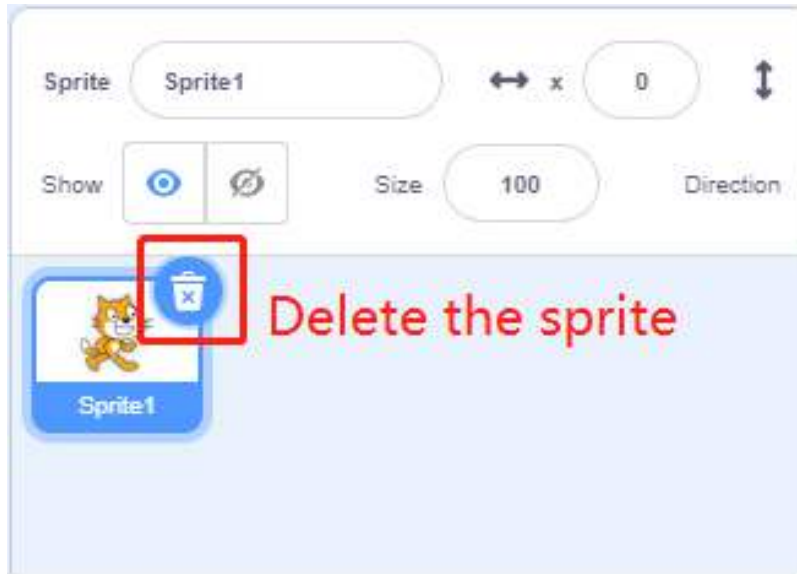

Then choose a sprite.

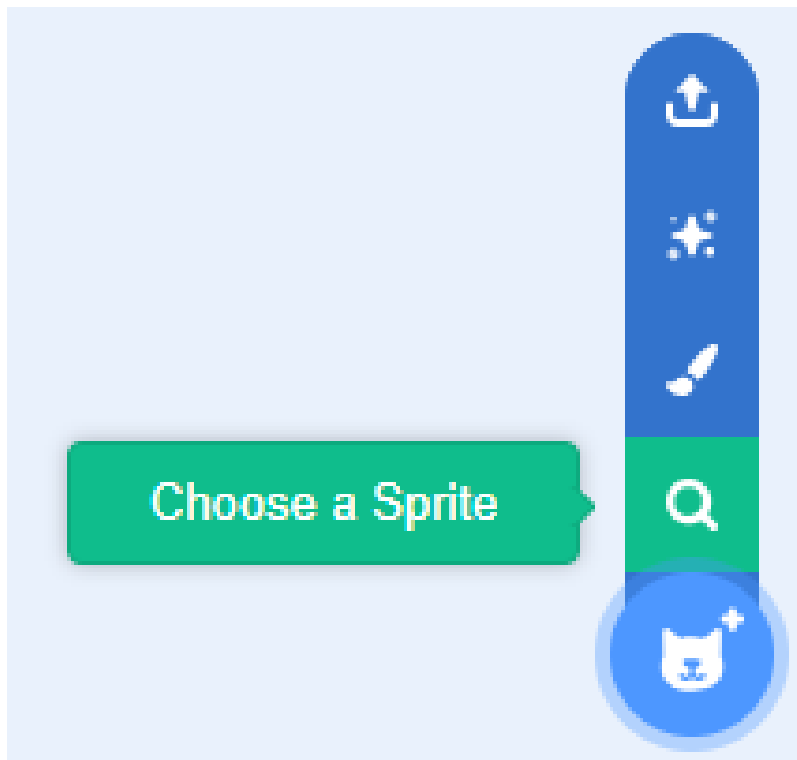

Find the Letter sprite.

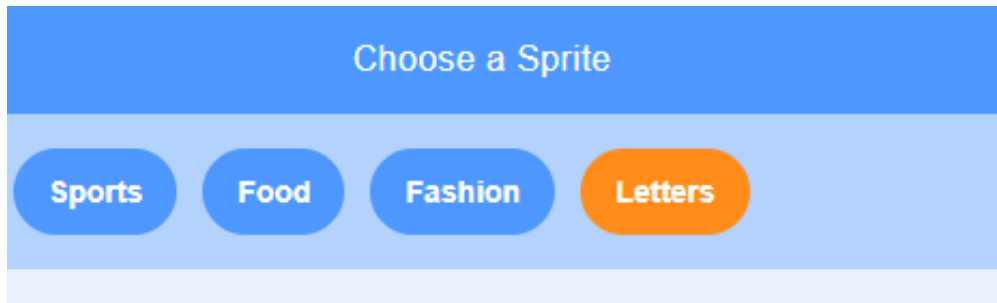

Repeat several times to spell out your name, like me, "Abby".

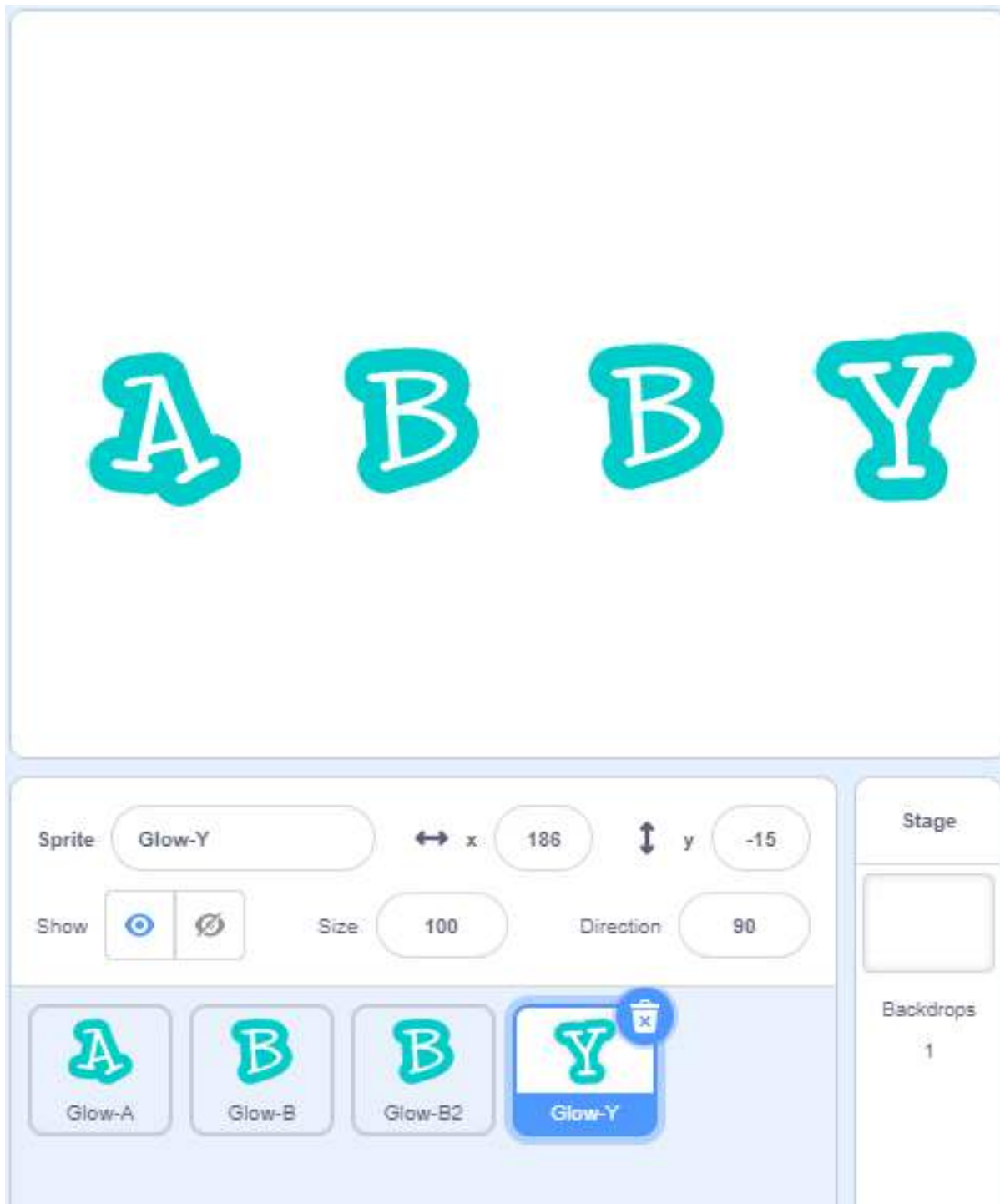

A can change its color.

Click on the Glow-A sprite and let's write a bit of code for it.

When A is clicked, it changes its color.

Click on the sprite, find **when this sprite clicked** in Events, and drag it to the right coding area.

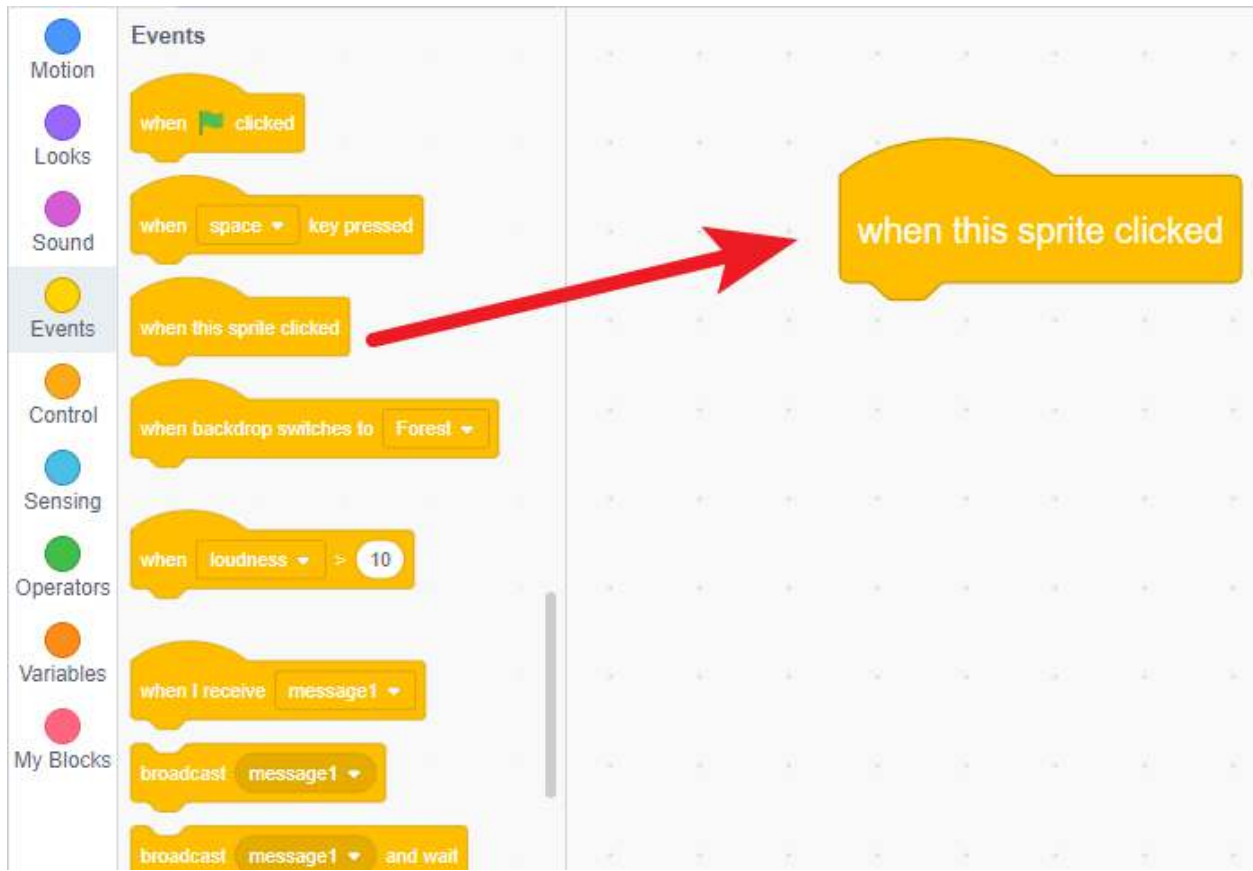

Drag **change color effect by...** from **Looks** to the bottom of when this sprite clicked.

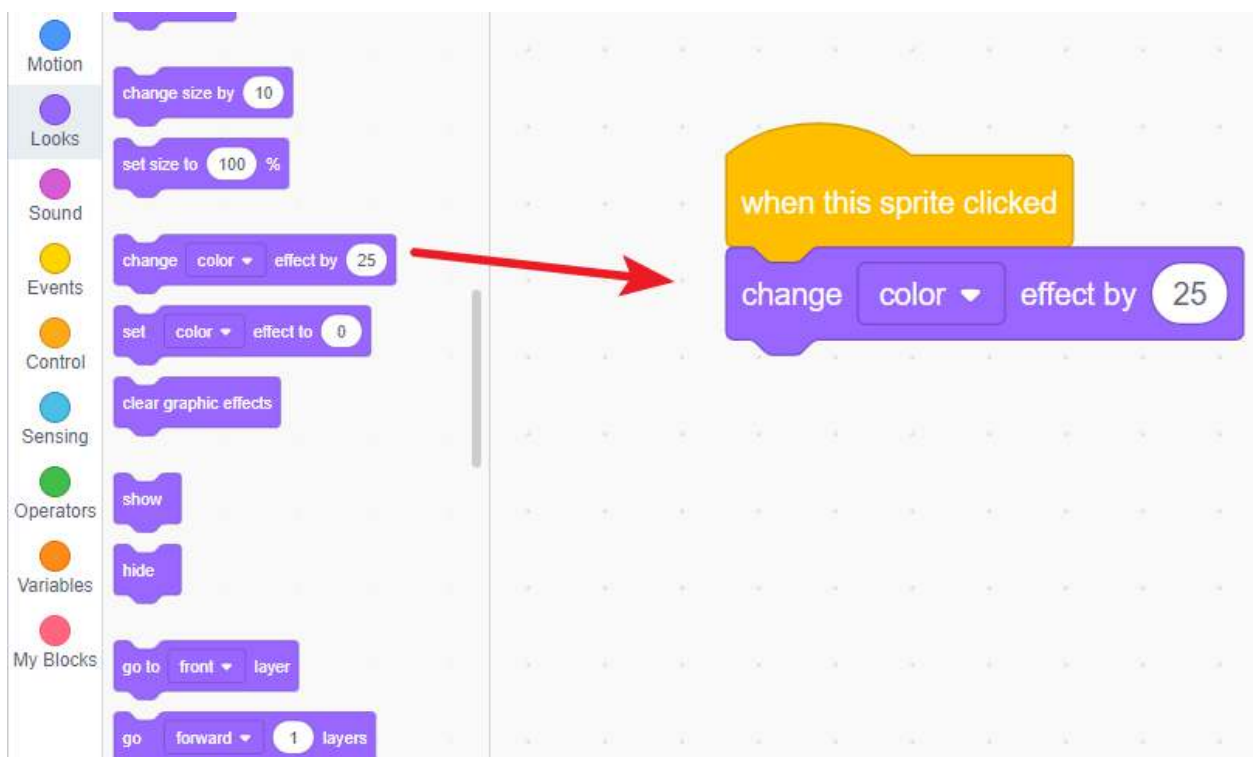

At this time, we click on the letter **A** on the stage and it will change its color.

B can rotate 360°.

Click on the Glow-B sprite, let's write a code for the Glow-B wizard. When the letter **B** on the stage is clicked, it will rotate in a circle.

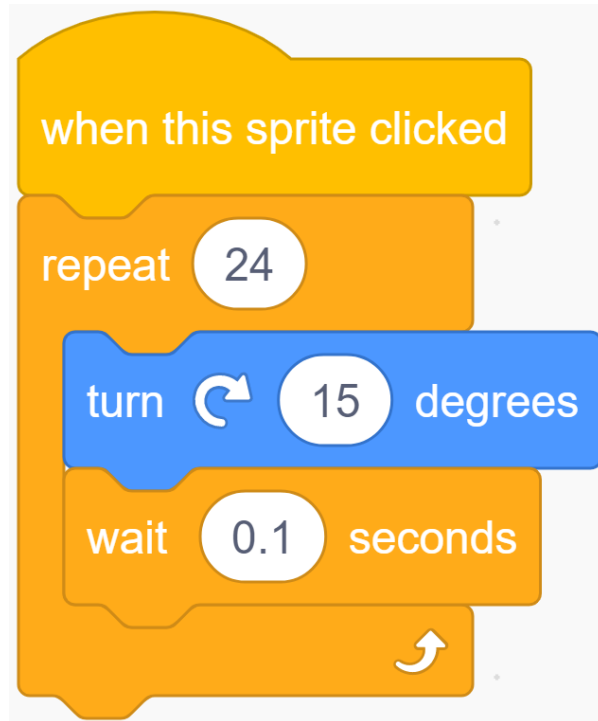

Do you know why B is rotated 15 degrees 24 times? Because $24 \times 15 = 360$, it turns 360 degrees!

B2 can zoom in and out.

Click on the Glow-B2 sprite, and let us write a code for the Glow-B2 sprite.

When the second **B** on the stage is clicked, it will zoom in and then zoom out.

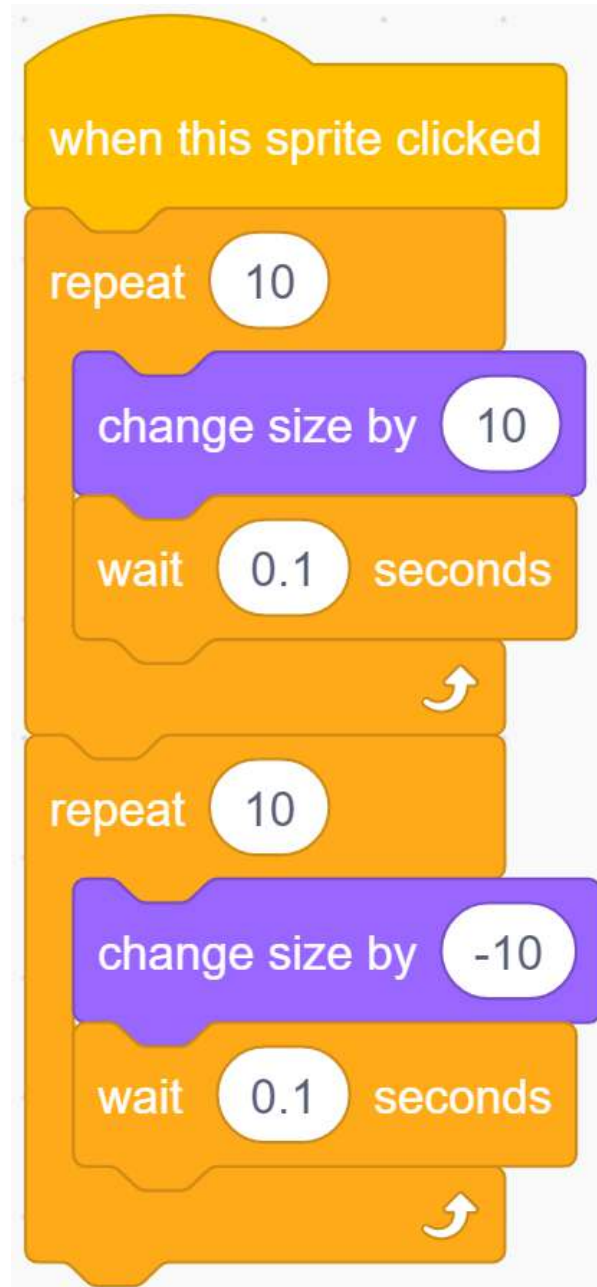

Y can show and disappear.

Click on the Glow-Y sprite and let us write a piece of code for the Glow-Y sprite. When the **Y** on the stage is clicked, it will repeatedly disappear and appear.



Challenge

I believe that you will be smart enough to program and implement this game soon. Next, we will add some challenges to enrich our game content.

- Add two new sprites, one of which will blink and change color when clicked; the other will zoom and rotate when clicked.

5.7.2 Create a Story

Description

Do you like to hear stories? For example, before going to bed, you can have a sweet dream at night by listening to a little story from your parents. Today we are going to “tell” the story of a little monkey looking for a banana on Scratch.

Click the green flag to start.

Or click [Create a Story](#), and then learn online tutorial on the Scratch official website.

Required Components

- A Screen

- Scratch 3 (either online or offline)

You Will Learn

- Choose the sprite you want.
- Let the sprites move around.
- Let the sprites talk to each other.
- Switch scenes.

Lesson Guide

This is a happy Monkey named Harley.

In the lower right corner of the Scratch, there are two areas-the character area and the stage area, where we can add the sprites and stage we want.

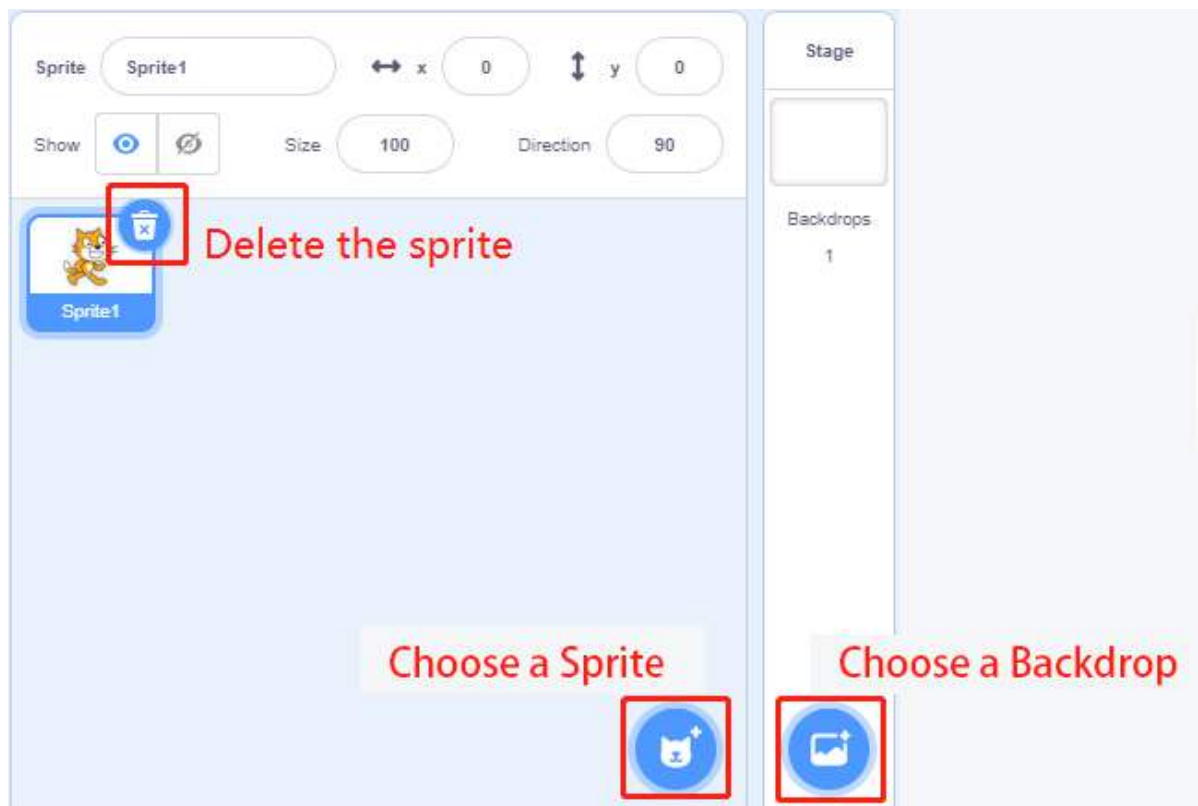

First the current sprite, and then click the **Choose a Sprite** button to add the sprite.

Here we need to find Monkey, click on it! You can use the search box above to find it. Here we give it a name **Harley**.



Harley is hungry. He asked his friend Perry where is the banana?

Click on your Harley sprite, and then click on the Event category. Drag **when clicked** to the coding area on the right.

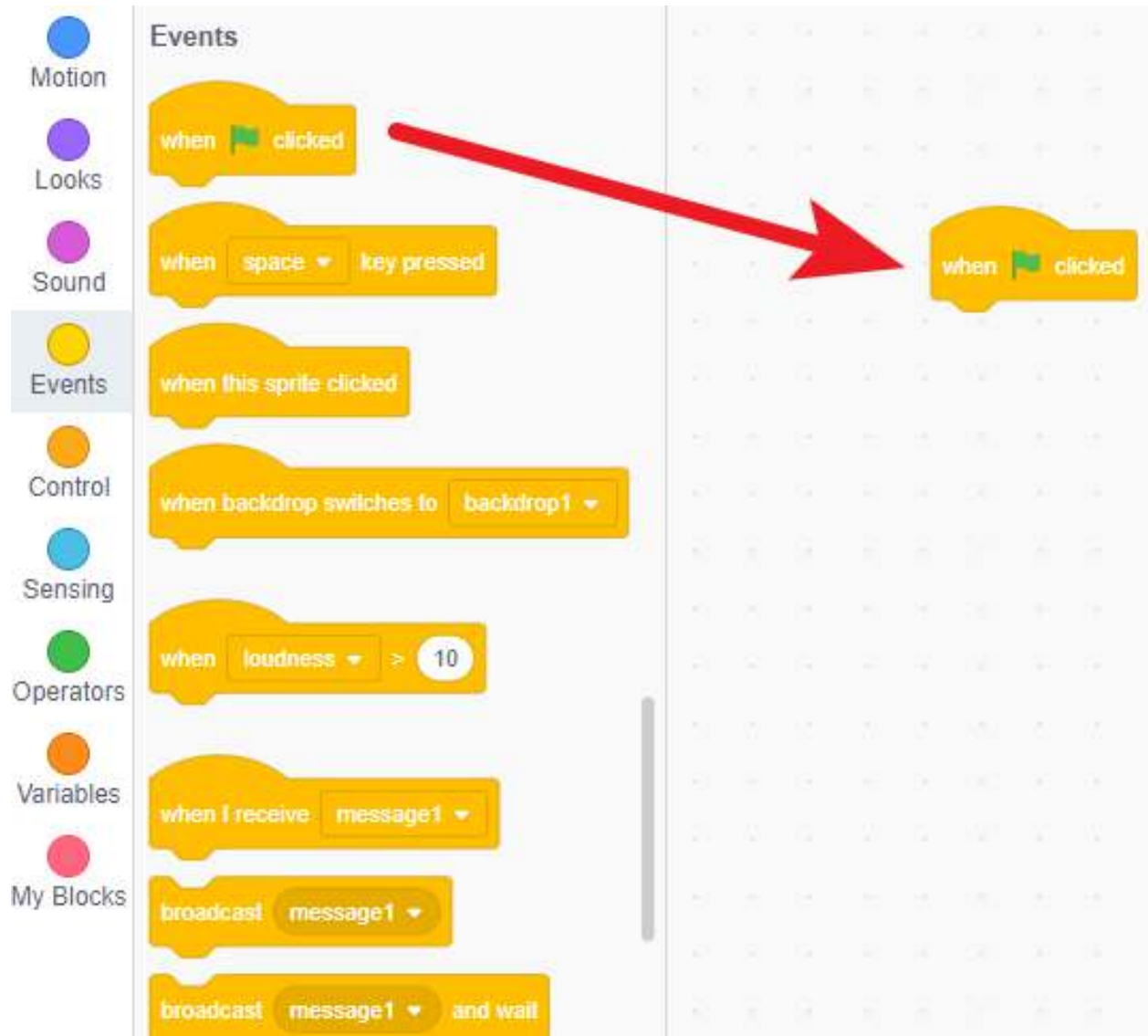

Click on the Looks category and drag say **“Hello!” for 2 second** to the bottom of “when clicked”.

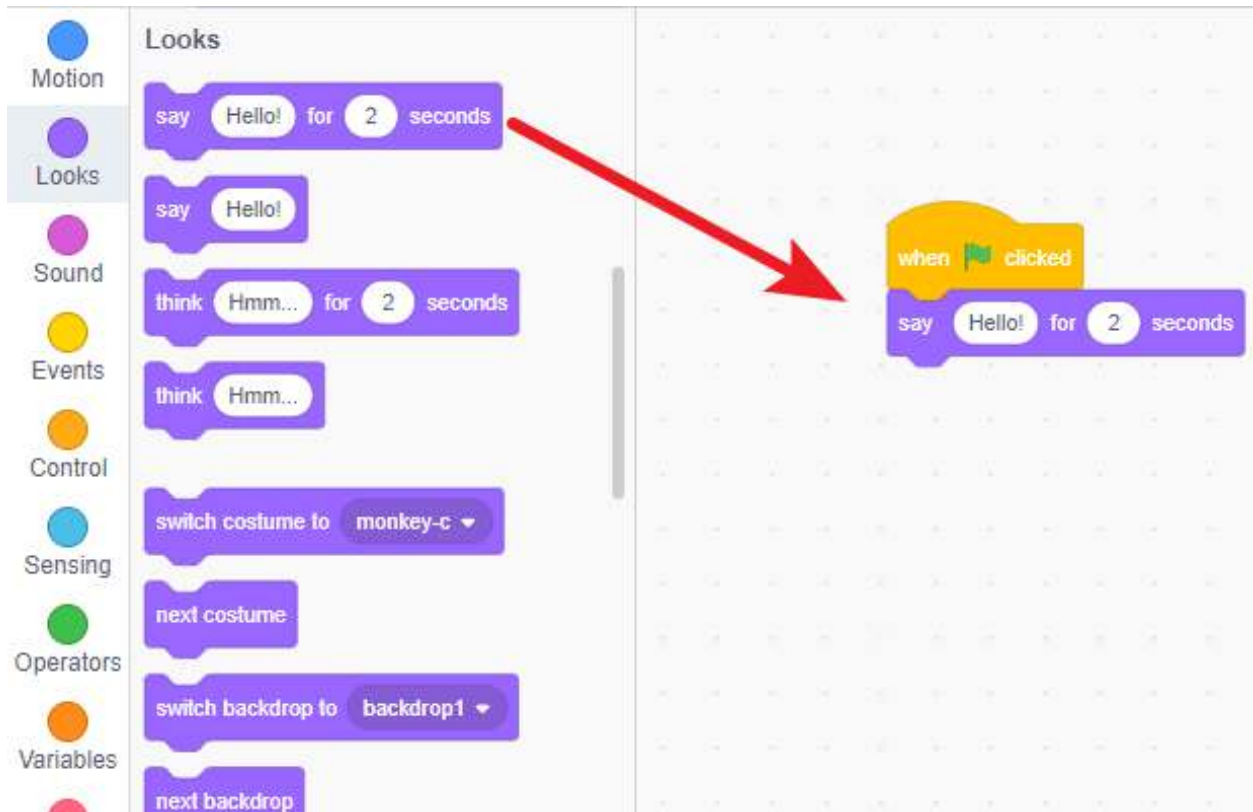

Change what it says and how long it says in the input box.



Perry had seen bananas in the park, so he told Harley.

Perry is a Frog, add Frog sprite and Forest backdrop.

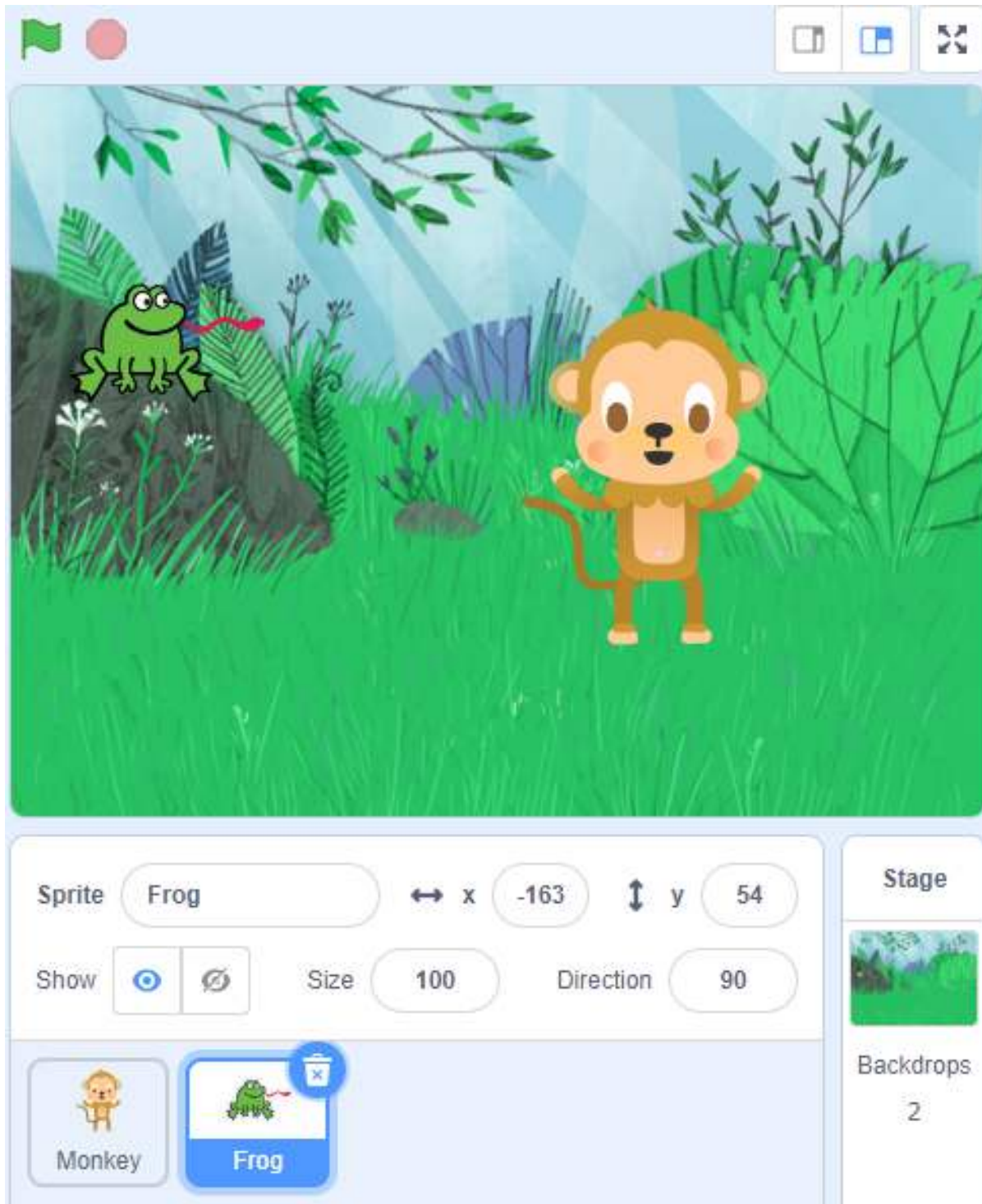

Click on the Frog sprite, add a 3 second **delay** block (wait for Harley to finish speaking), and then it speaks.



Now, click on the green flag, we can see Harley and Perry chat.

Harley went to the park and found bananas on the table.

Now, click on the Backdrop and let it switch after 6 seconds (after the conversation ends).

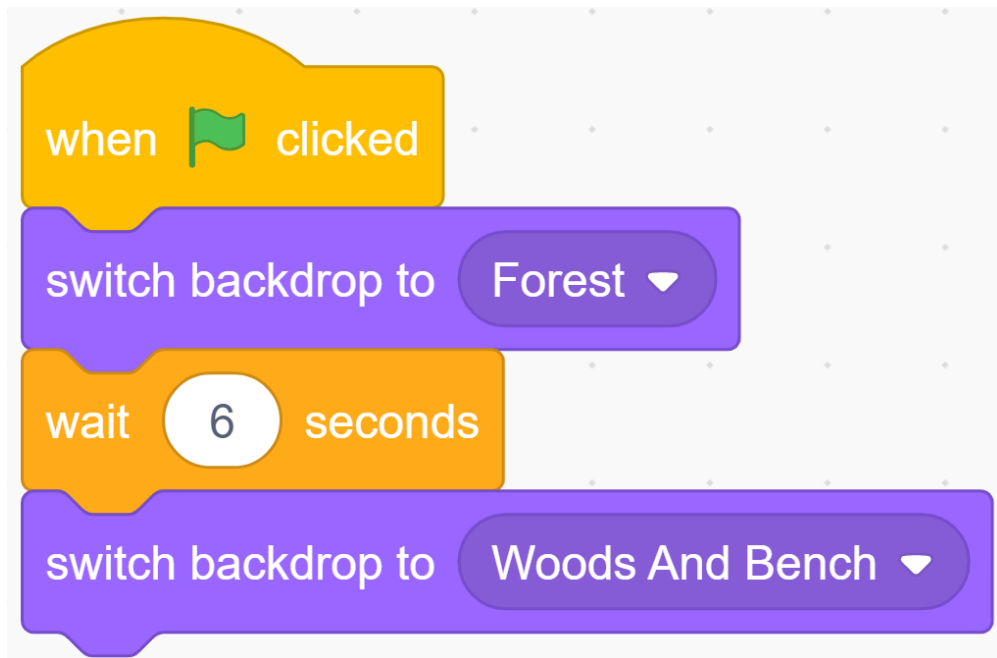

Now, by clicking on the green flag, we can see that the Perry and Harley “come” to the park together after the conversation.

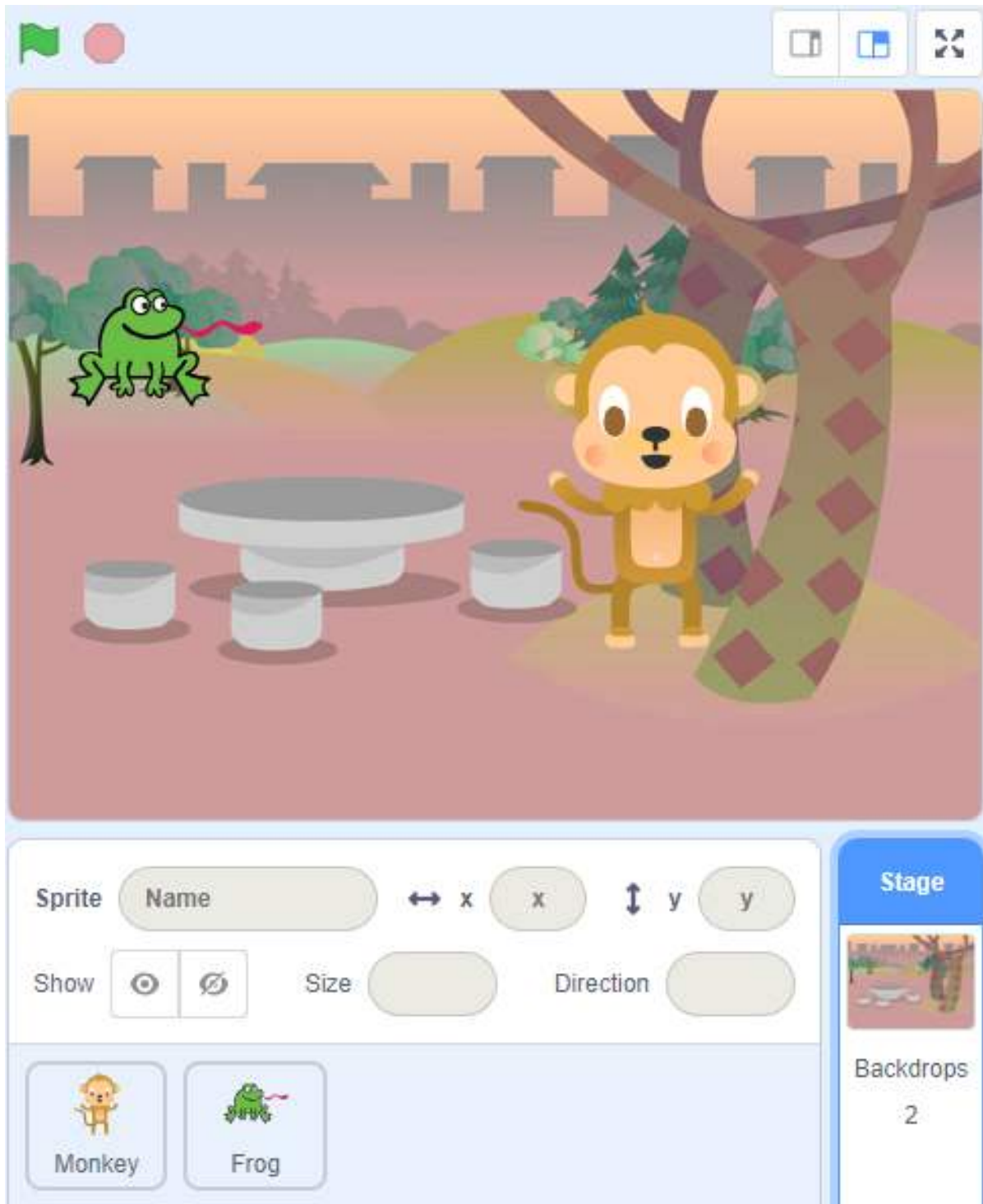

But Harley should come to the park alone, and there should be bananas on the table. So, we have to make Perry “disappear”.

Click on the Frog sprite, add an event, **when backdrop switches to...**, and find “hide” and “show” in Looks. Let the Perry appear at the right time!

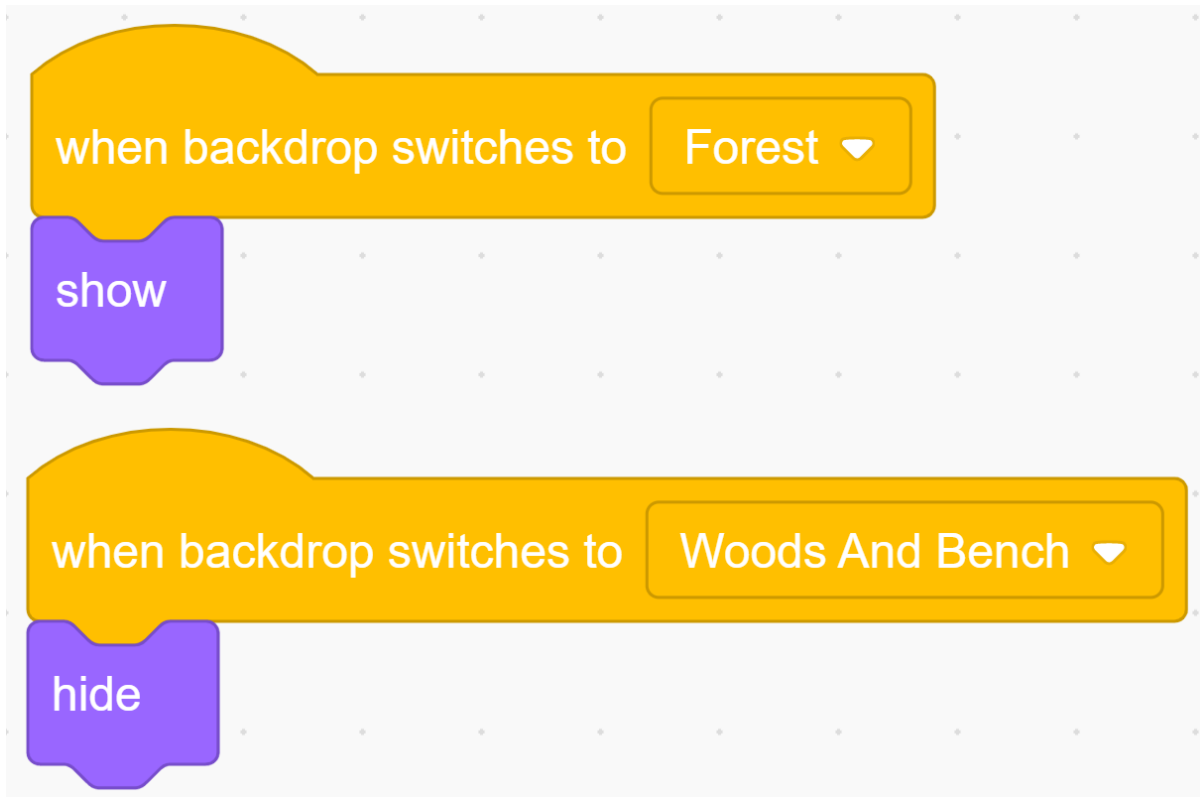

Add the Banana sprite and adjust the angle.



Also let it appear at the right time.

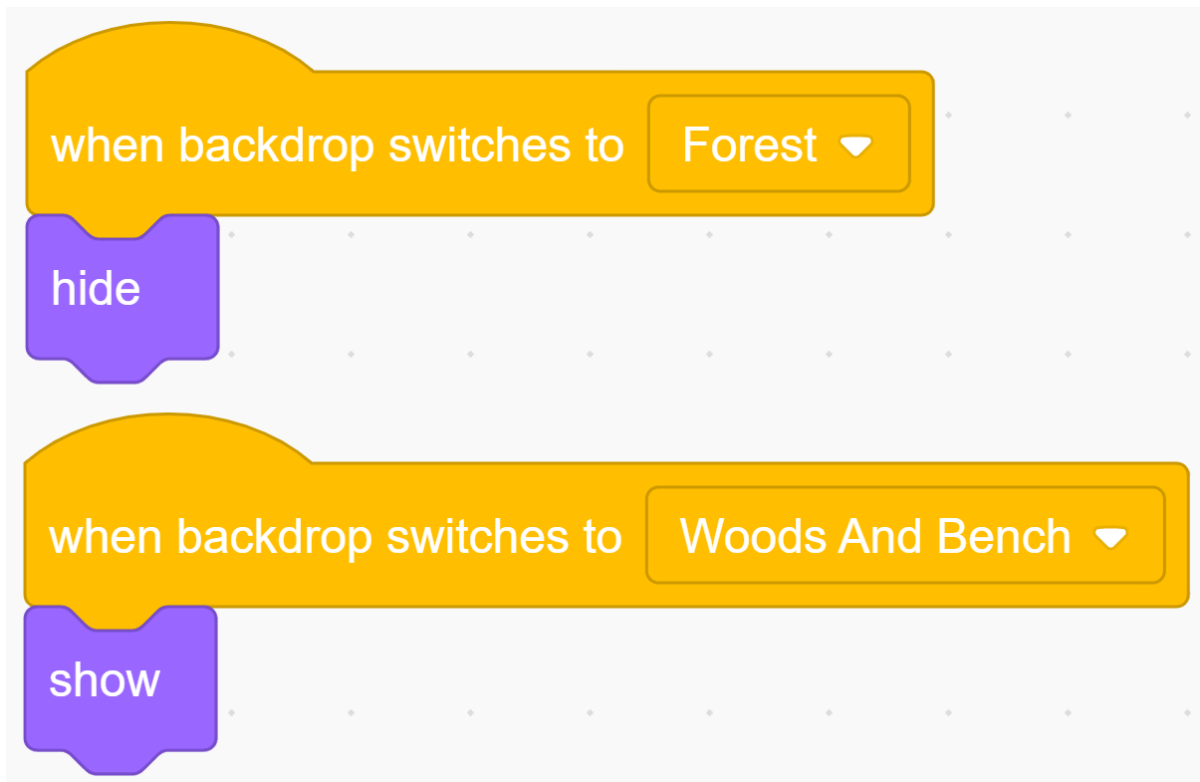

Now, click on the green flag and you can see a complete story.

Challenge

Believe that you who are smart will be able to program and implement this game soon, then we will add some challenges to enrich our story content.

- Harley will take the bananas back to the Forest, share it with Perry.

5.7.3 Make Music

Description

Everyone has been to the concert hall. It is filled with a dazzling array of musical instruments. These musical instruments make wonderful sounds under the performance of musicians.

Today we will also be a musician and add some musical instruments on the stage of Scratch. When you click on different instruments, they will emit corresponding instrument sounds.

Click the green flag to start.

Or click [Make Music](#), and then learn online tutorial on the Scratch official website.

Required Components

- A Screen
- Scratch 3 (either online or offline)

You Will Learn

- Use the Scratch **Add Extension** function to add music extension.
- Modify the initial size of the sprite.
- Let the sprites do some actions.

Lesson Guide

We Need the Drums.

Click on the “Add Extension” icon at the bottom left of Scratch, select **Music**, and then you will find a new extension-Music on the left side of Scratch.

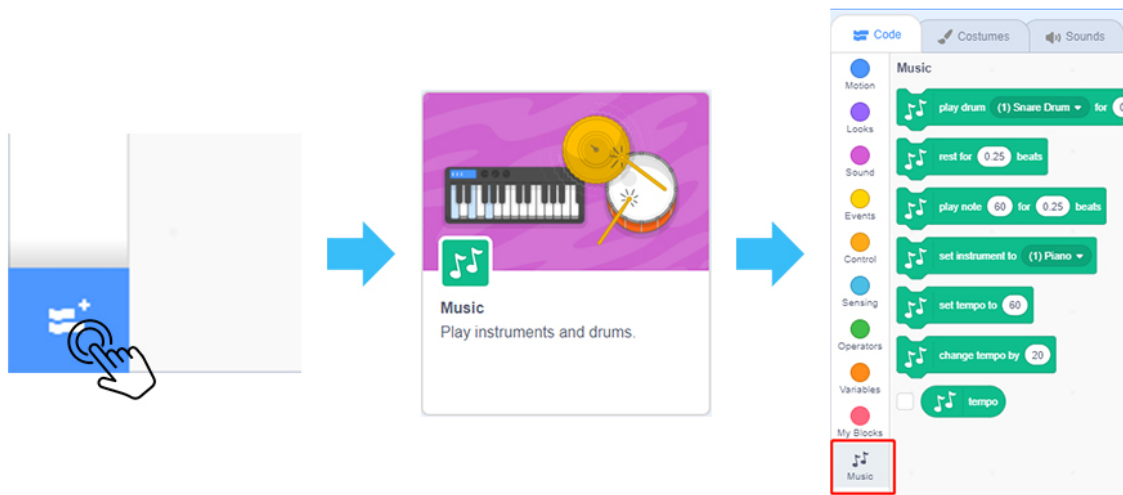

Delete the original sprite, add Drum-highhat sprite and Drum-snare sprite.

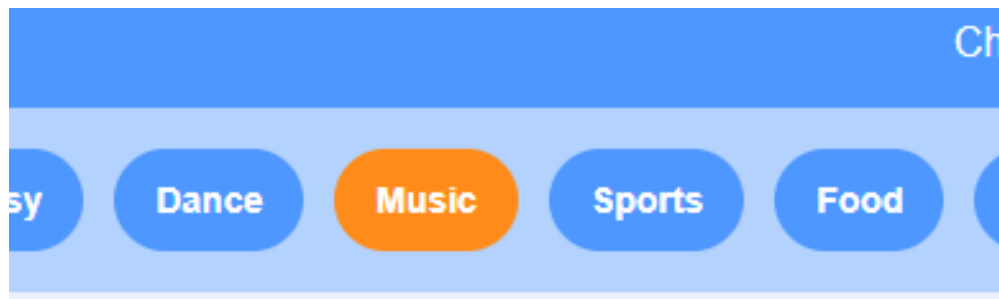

Adjust the Drum-highhat sprite and Drum-snare sprite to the appropriate size.

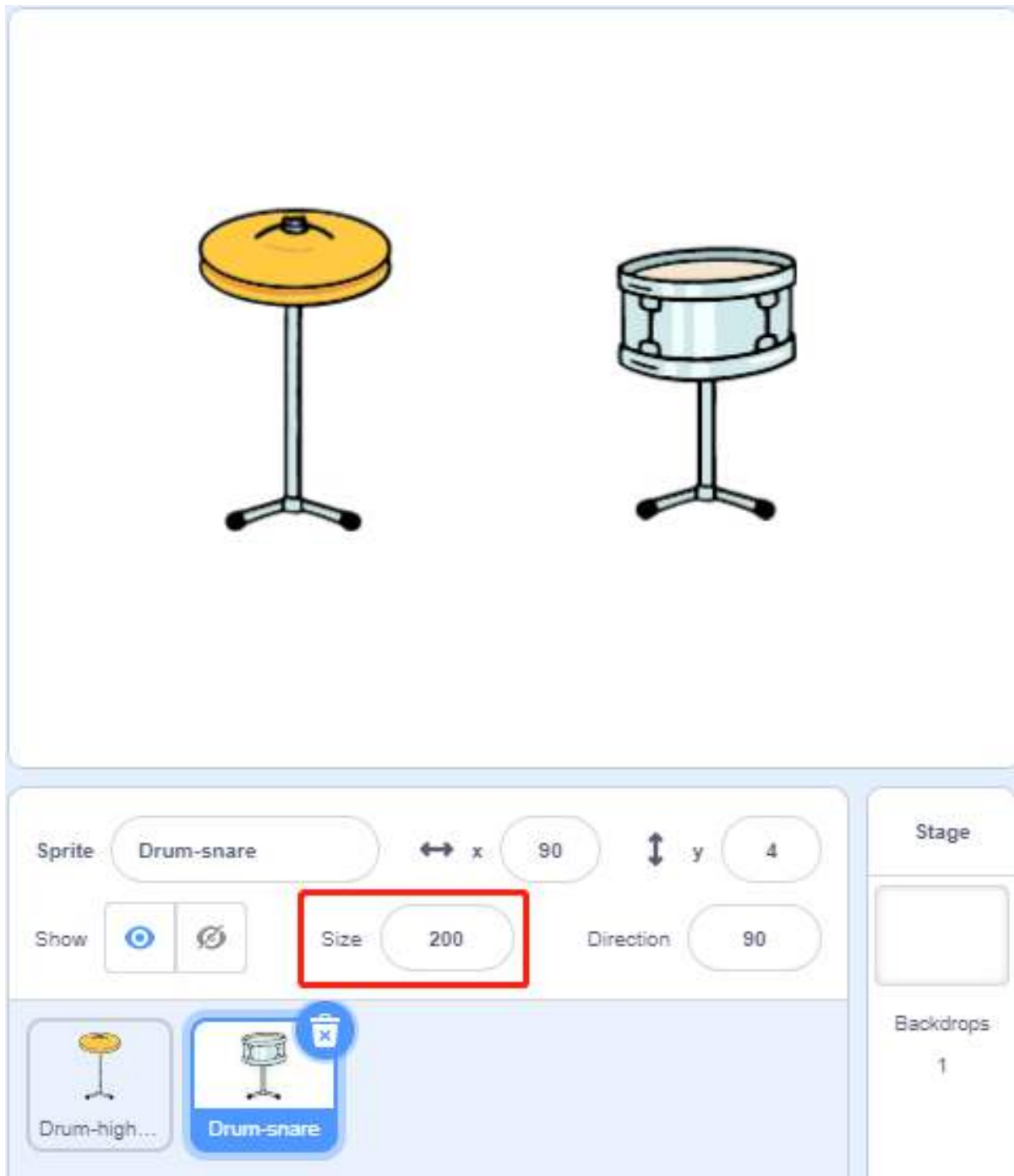

Play Drum-highhat.

Click on the Drum-highhat sprite and drag out the **play drum...** block in the Music expansion module.

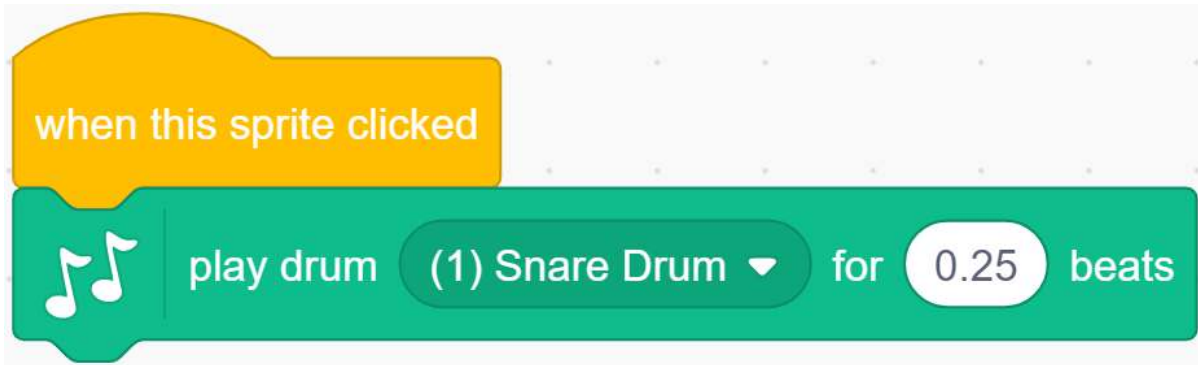

Change the option to **(5) Open Hi-Hat**, then use the “next costume” block to switch the appearance of Drum-highhat.

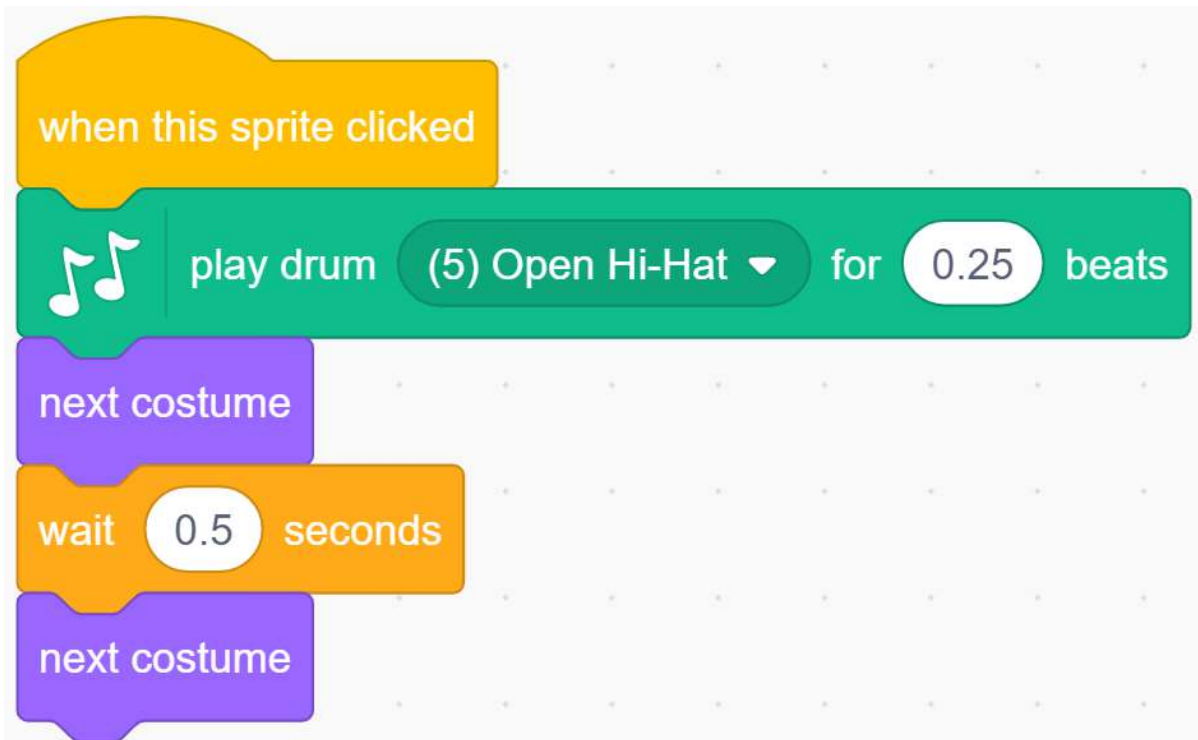

Now, you can play the Drum-highhat.

Play Drum-snare.

Click on the Drum-snare sprite and drag out the **play drum...** block in the Music expansion module.

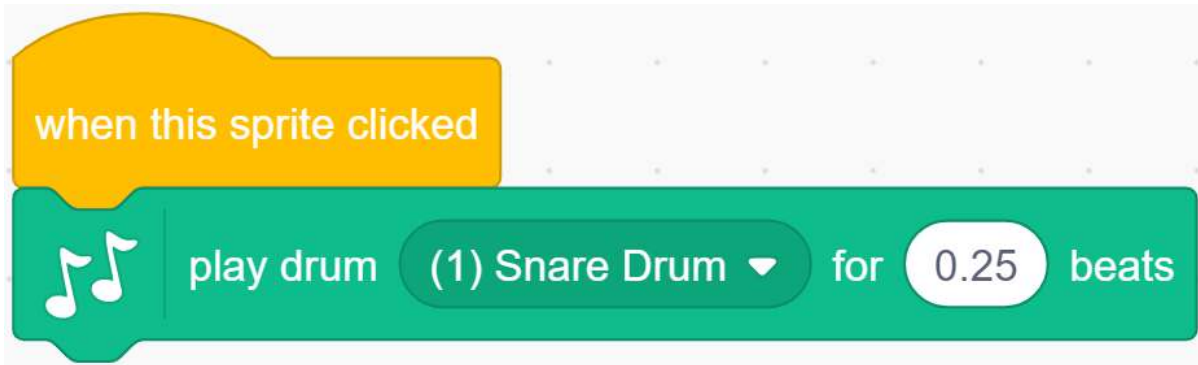

Change the option to **(1) Snare Drum**, then use the “next costume” block to switch the appearance of Drum-snare.

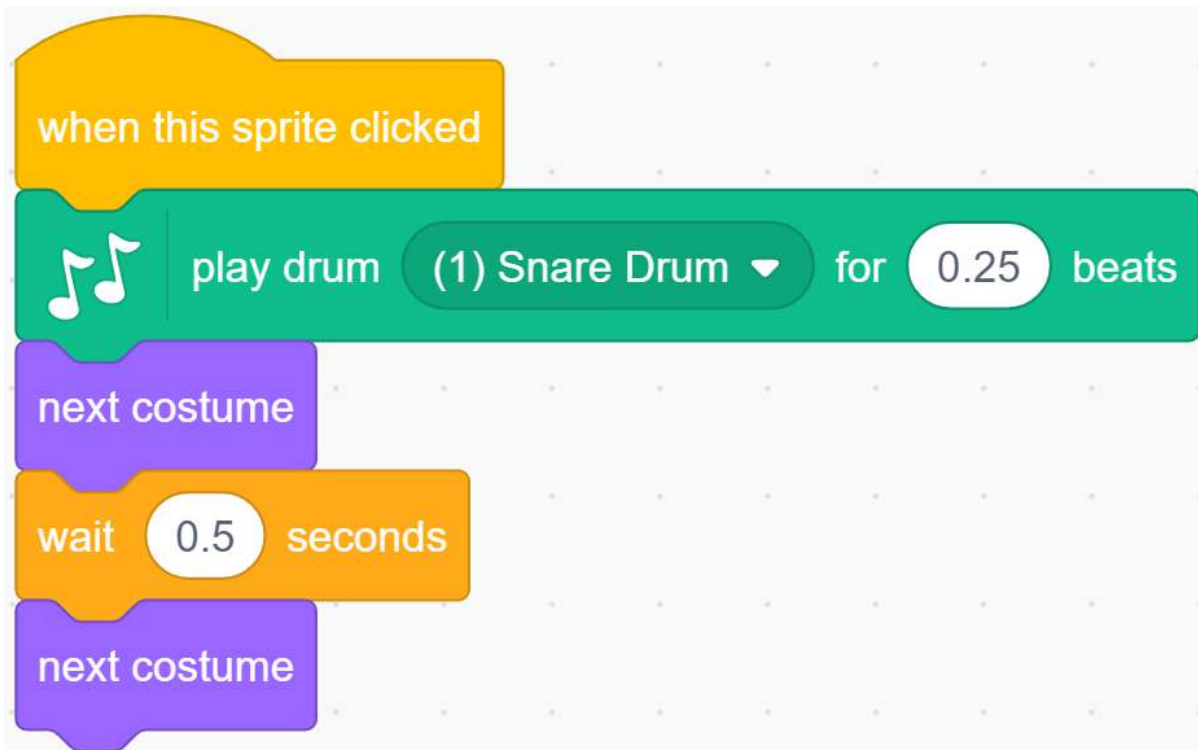

Now, you can play the Drum-snare.

Challenge

I believe that you will be smart enough to program and implement this game soon. Next, we will add some challenges to enrich our game content.

- Add Drum sprite, Drum Kit sprite and Drum-cymbal sprite, modify their size, and choose suitable sound effects. In this way we have made a drum set.

Sprite	Size	Instrument tone options
Drum	200	(3)Side Stick
Drum Kit	150	(2)Bass Drum
Drum-cymbal	200	(4)Crash Cymbal

5.7.4 Clicker Game

Description

Today we will play a game of poking balloons.

Click the green flag to start.

Or click [Clicker Game](#), and then learn online tutorial on the Scratch official website.

Required Components

- A Screen
- Scratch 3 (either online or offline)

You Will Learn

- Pick random number.
- Change the position, size and color of the sprite.
- Make a variable.

Lesson Guide

Let the balloons appear randomly.

First, add Balloon1 sprite and Colorful City backdrop.

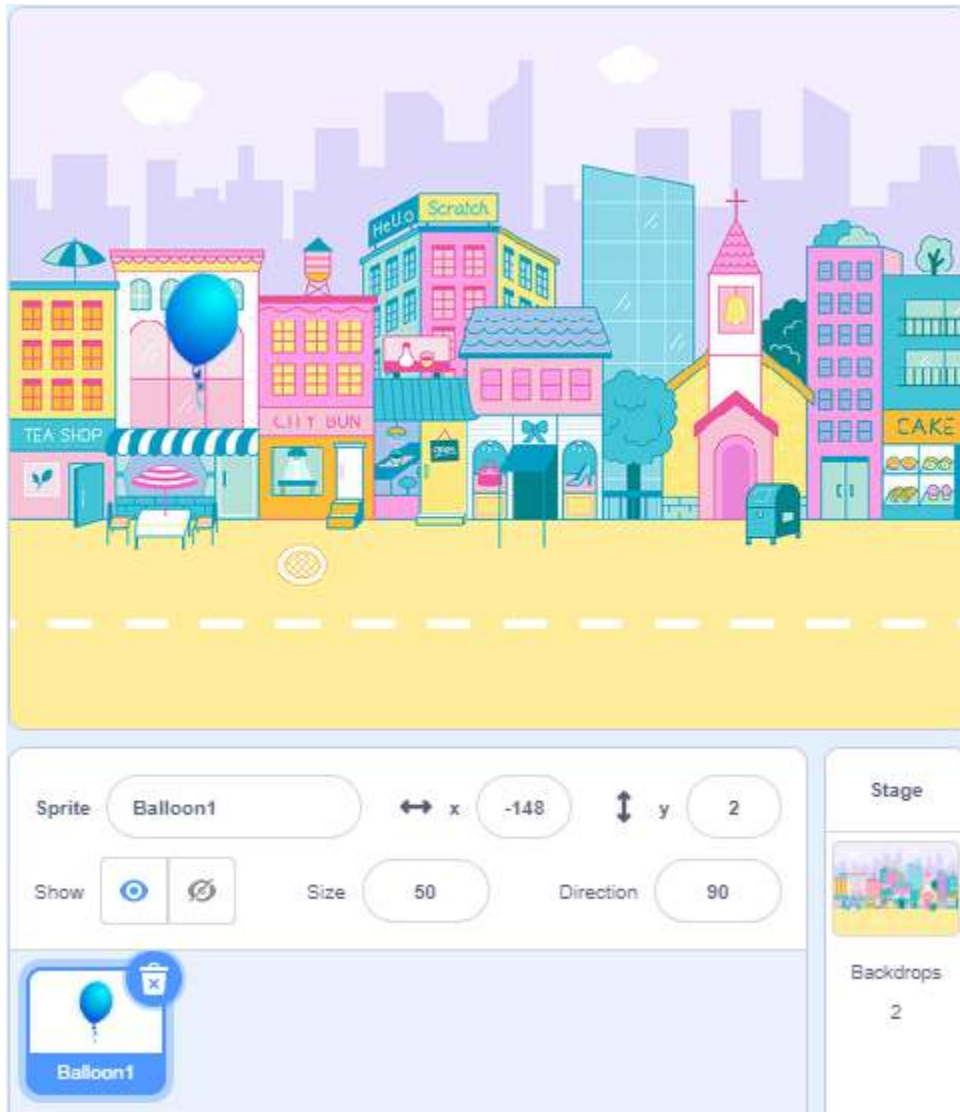

Set the balloon to a random position.

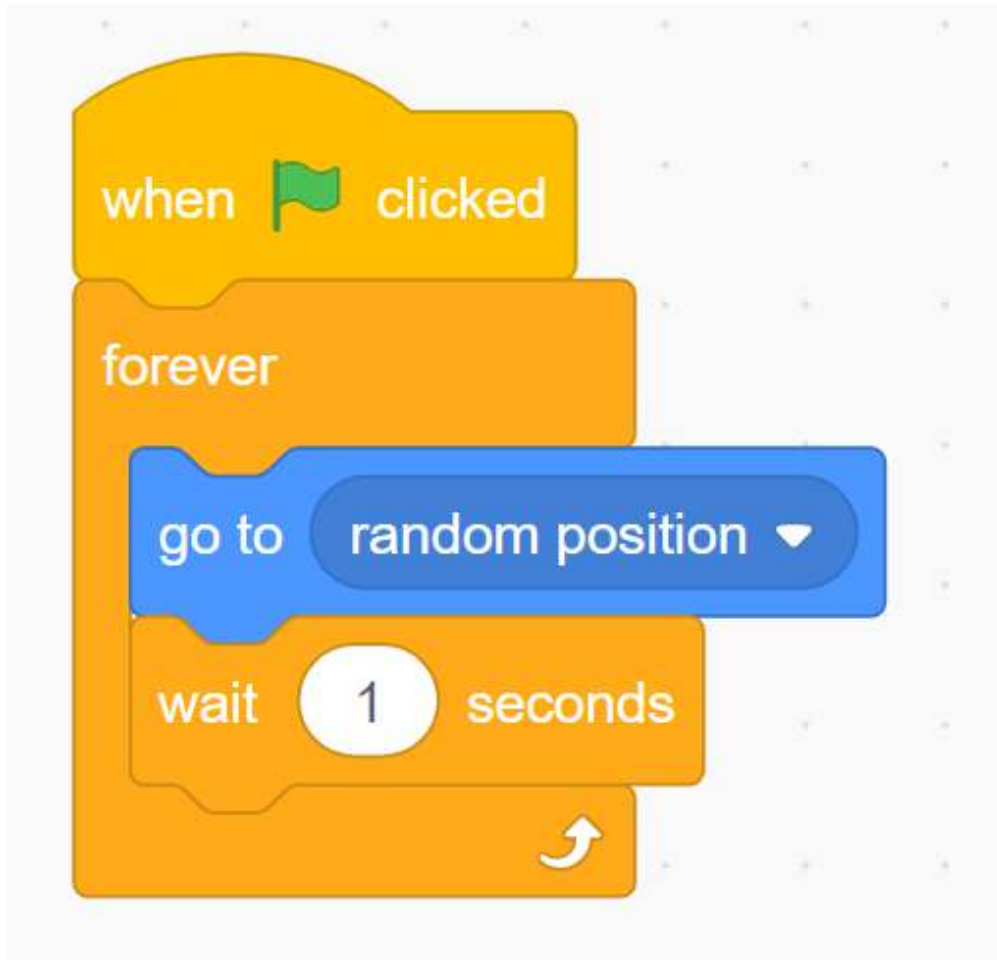

Let it change the color and size randomly.

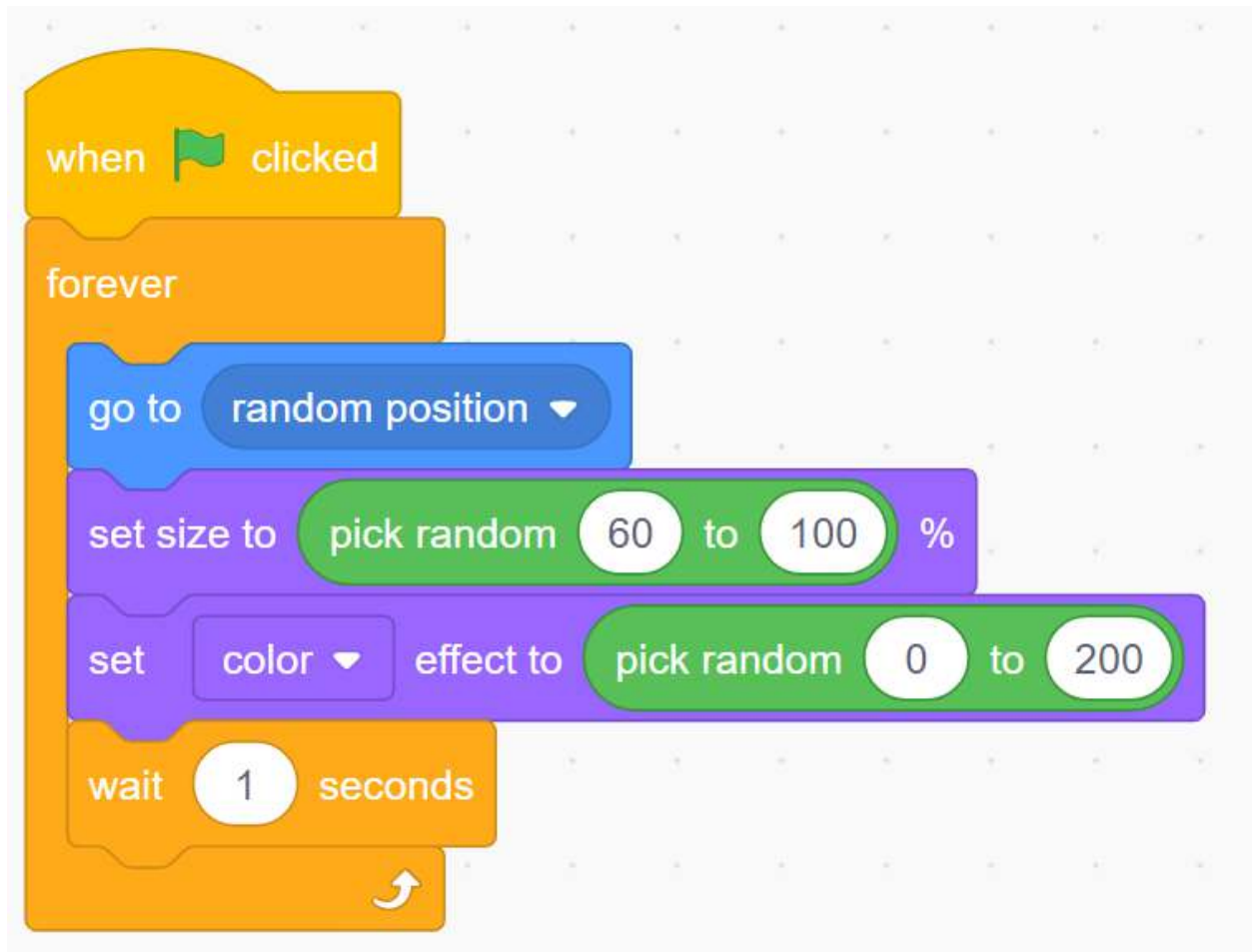

Now, run the green flag and you can see the balloons randomly change in the stage area.

Click on the balloon to add score.

Now, we need to establish a scoring mechanism. Whenever the balloon is clicked, the score will increase by one.

Create a variable (it can help us keep track of and store the score). In Variables, select **Make a Variable** and named **score**.

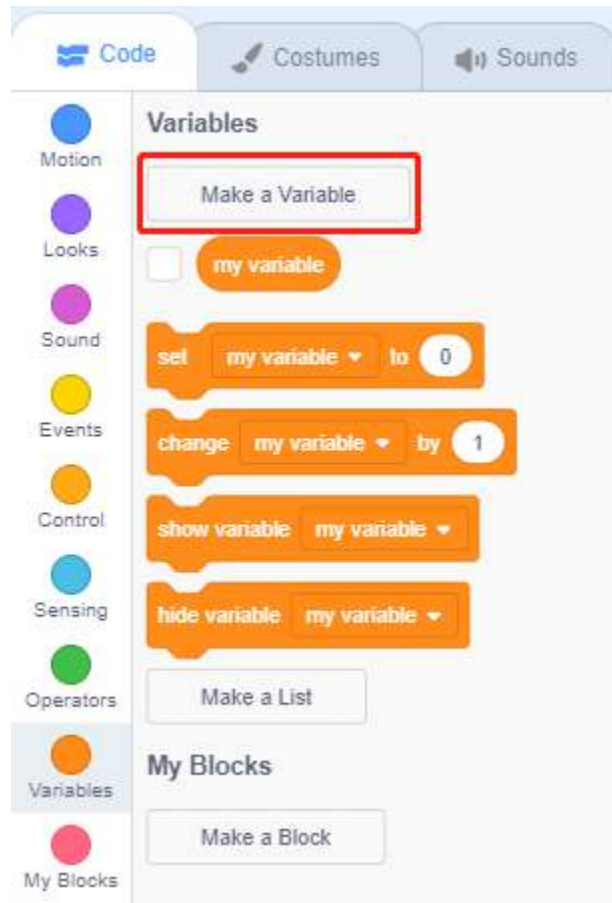

We will see it in the upper left corner of the stage.

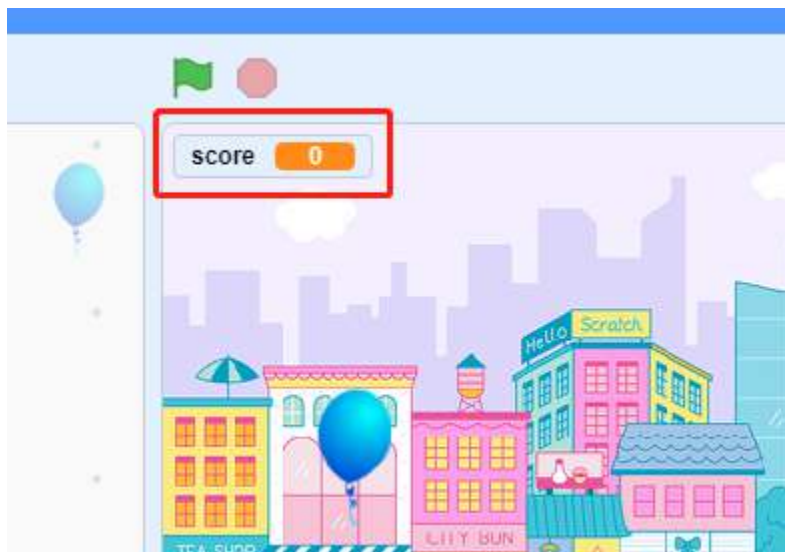

When the balloon is clicked, the score is increased by one. When you click the green flag (the game starts), the score will be reset to zero.

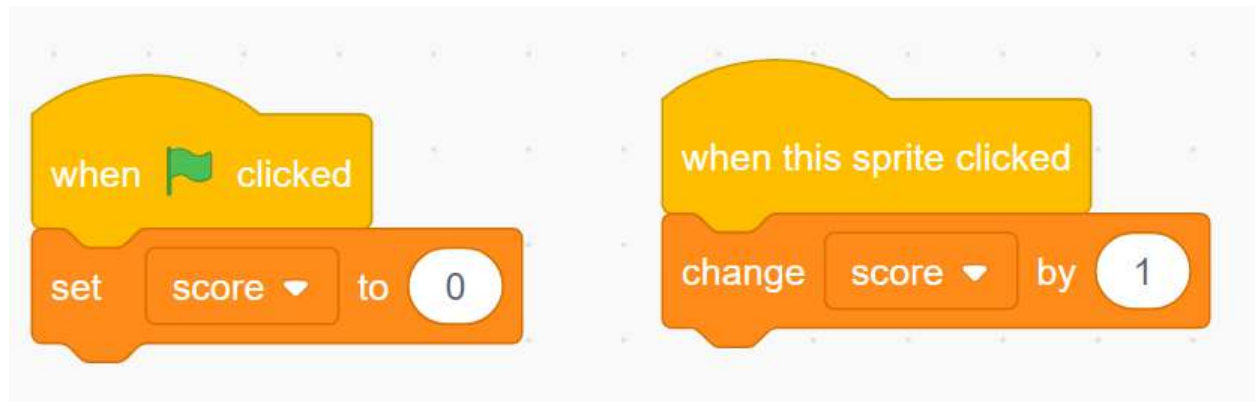

Now, click the green flag above the stage area to start the game, and click the balloon to increase your score!

Challenge

I believe that you will be smart enough to program and implement this game soon. Next, we will add some challenges to enrich our game content.

- When the balloon is clicked, the sound effect of “POP” is emitted.
- Let the Pufferfish sprite appear randomly on the stage as well, if you click on it, you will lose score!

5.7.5 Shooting Game

Description

Have you seen those shooting games on TV? The closer a contestant shoots a bullet on the target to the bullseye, the higher his score.

Today we are also doing a shooting game in Scratch. In the game, let the Crosshair shoot as far as possible to the bullseye to get a higher score.

Click on the green flag to start. Use the space bar to shoot an bullet.

Or click [Shooting Game](#), and then learn online tutorial on the Scratch official website.

Required Components

- A Screen
- Scratch 3 (either online or offline)
- Crosshair Sprite
- Target Backdrop

You Will Learn

- Upload new sprites and background images to Scratch.
- The coordinate range of the Scratch stage.
- Stop scripts run by other sprites and get the result of the game.

- Use of Scratch color picker.

Lesson Guide

Arrange the Crosshair and targets.

First, delete the previous sprite, upload the Crosshair sprite and the target background, you can find them under the path `7-diy-touch-screen/scratch/materials` (You have downloaded from [github - 7-diy-touch-screen](#) before.).

Click the icon below the sprite list, select “Upload Sprite Option”, find the **Cross Hair.svg** file, and upload it. Similarly, upload the backdrop, **Target.jpg**.

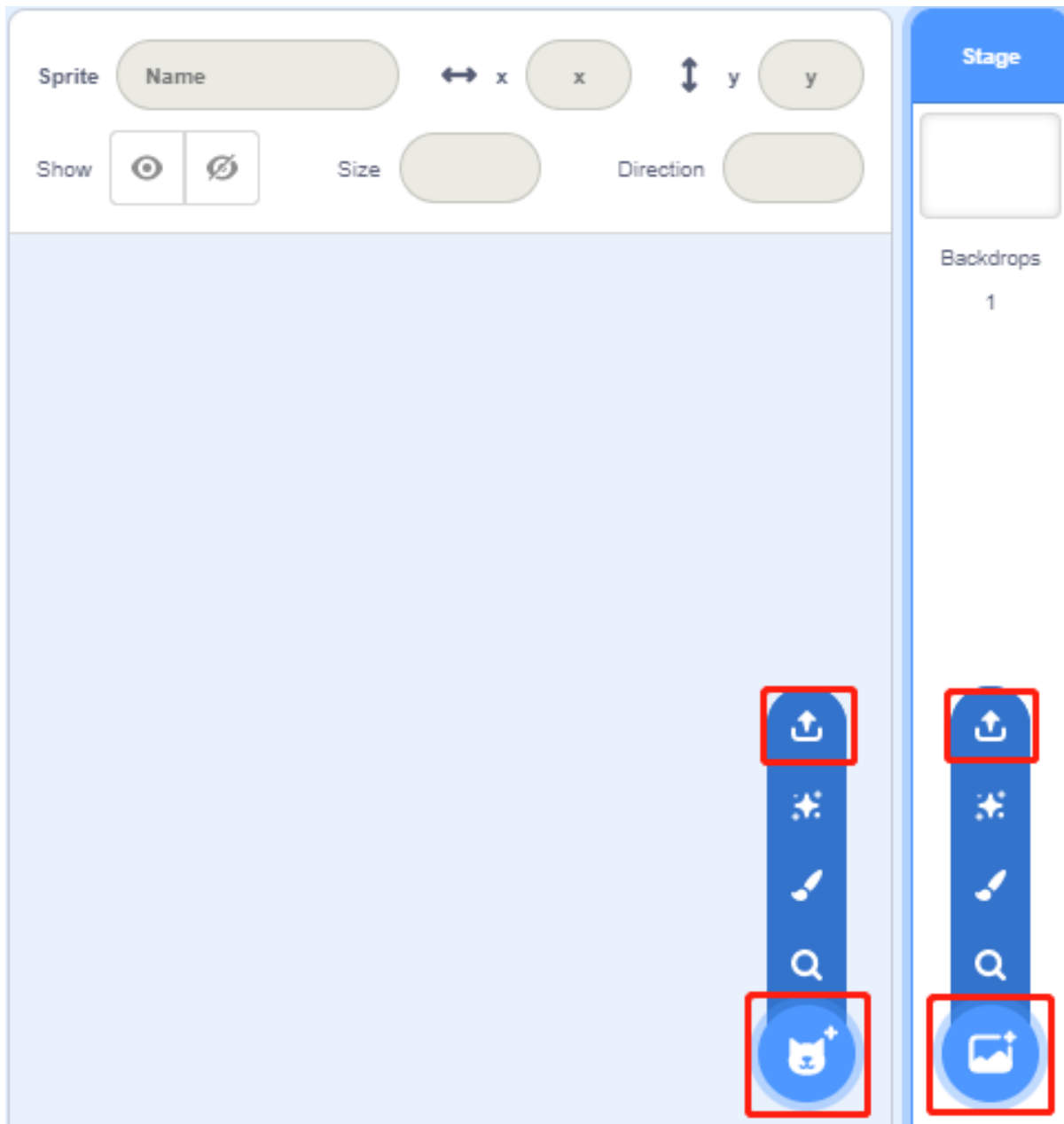

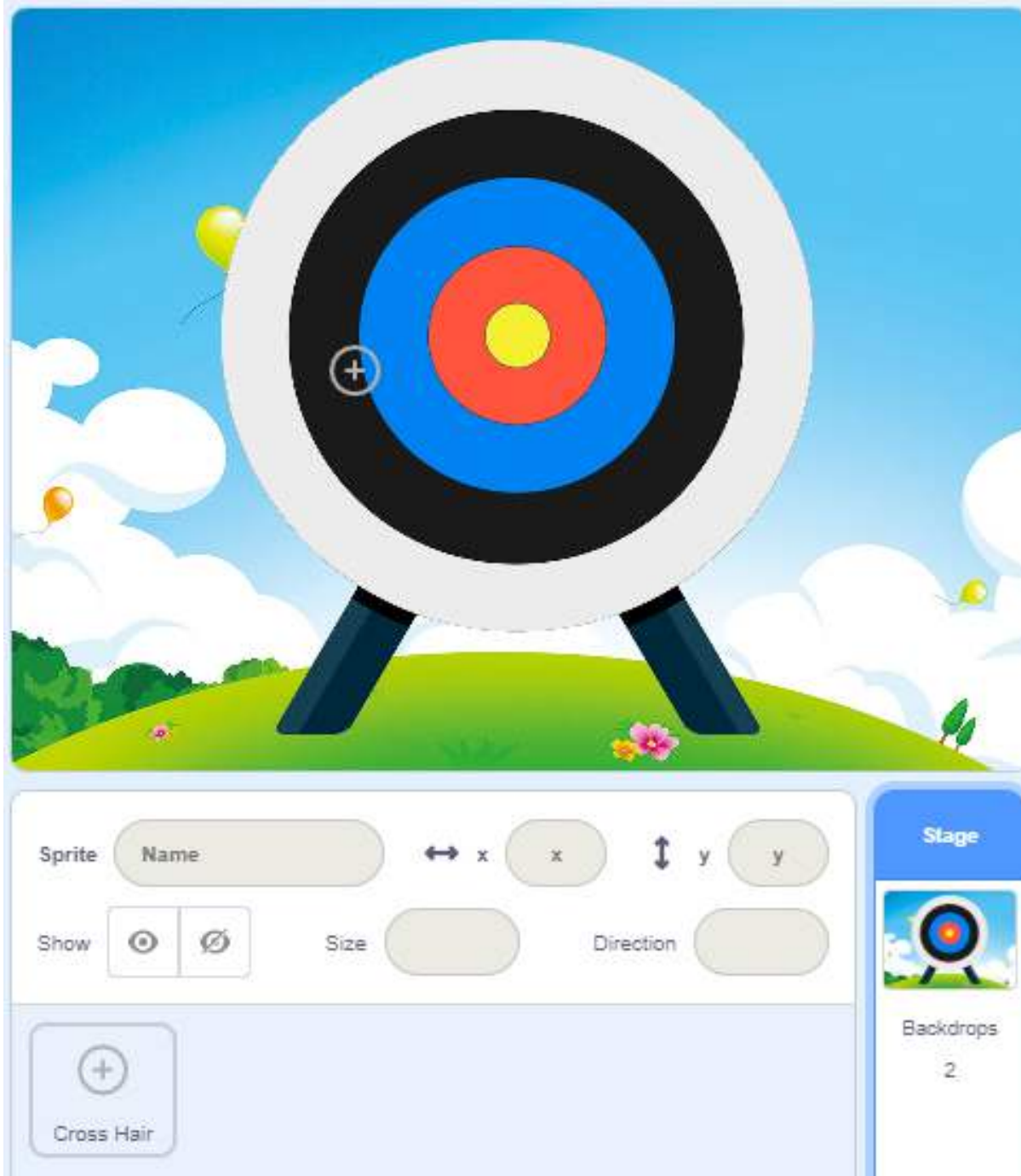

Let's take aim.

When aiming, the Crosshair will slightly shake, we are now going to use the **glide...** block to achieve this effect.

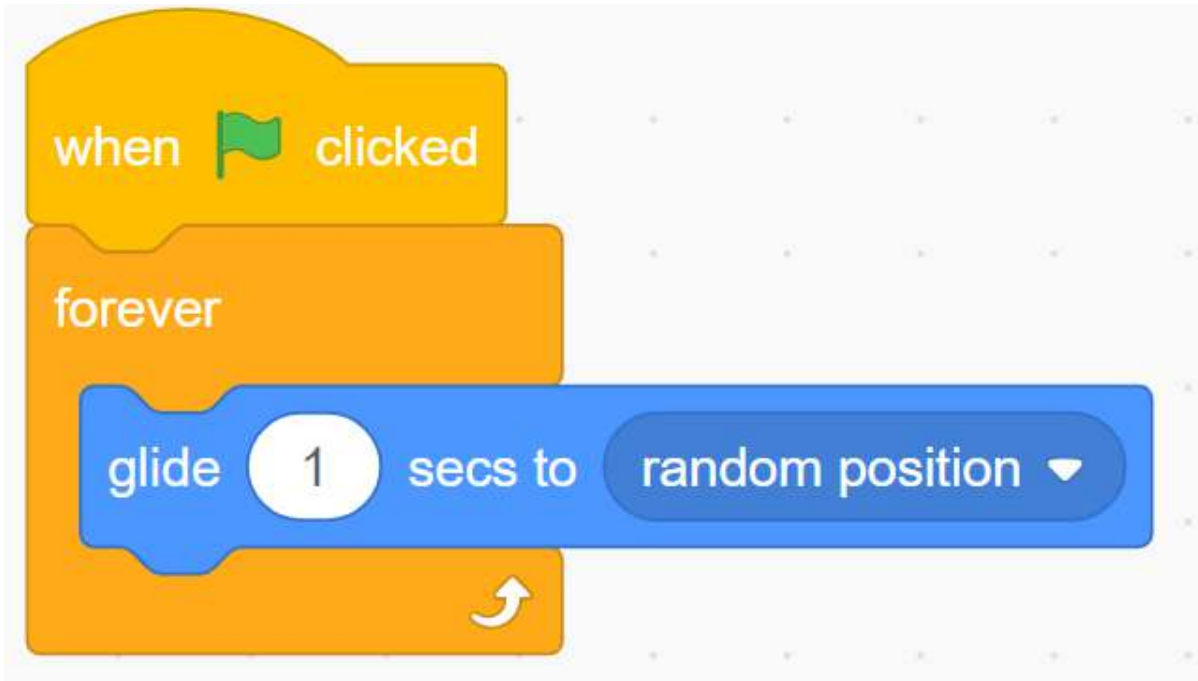

Set the random position and size of the Crosshair sprite.

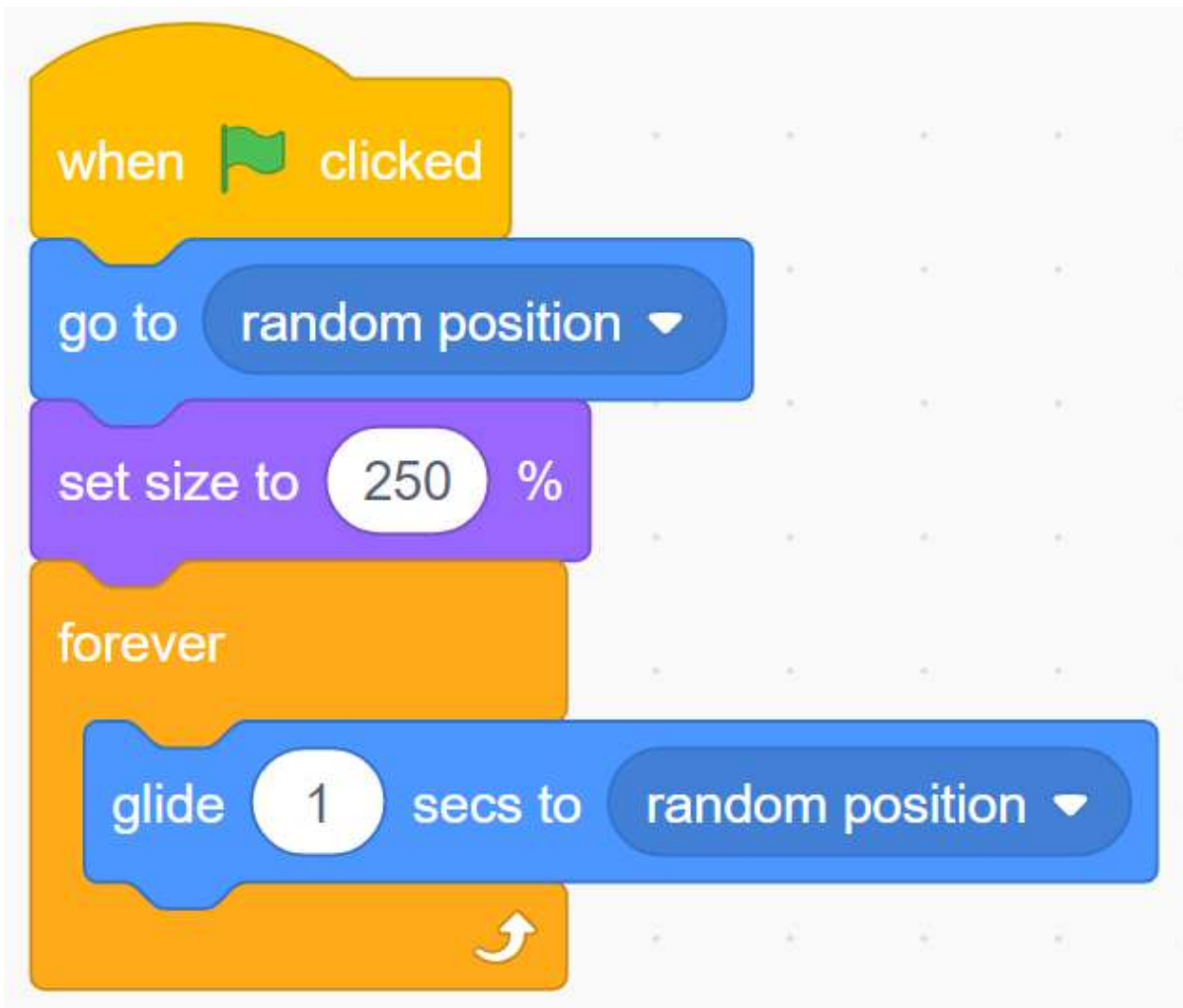

Now, click on the green flag to see the effect of this aiming... very good. Let's guess, change the time in the **glide...** block, will the front sight become more stable? Or is it more swaying?

Let's shoot!

We are now going to express the effect of shooting bullets.

how is it? Stop the crosshair moving, and then let it shrink quickly to create a shooting effect.

This means that when the space bar is pressed, we need to stop shaking the code of the Crosshair and keep the size of the Crosshair sprite shrinking.

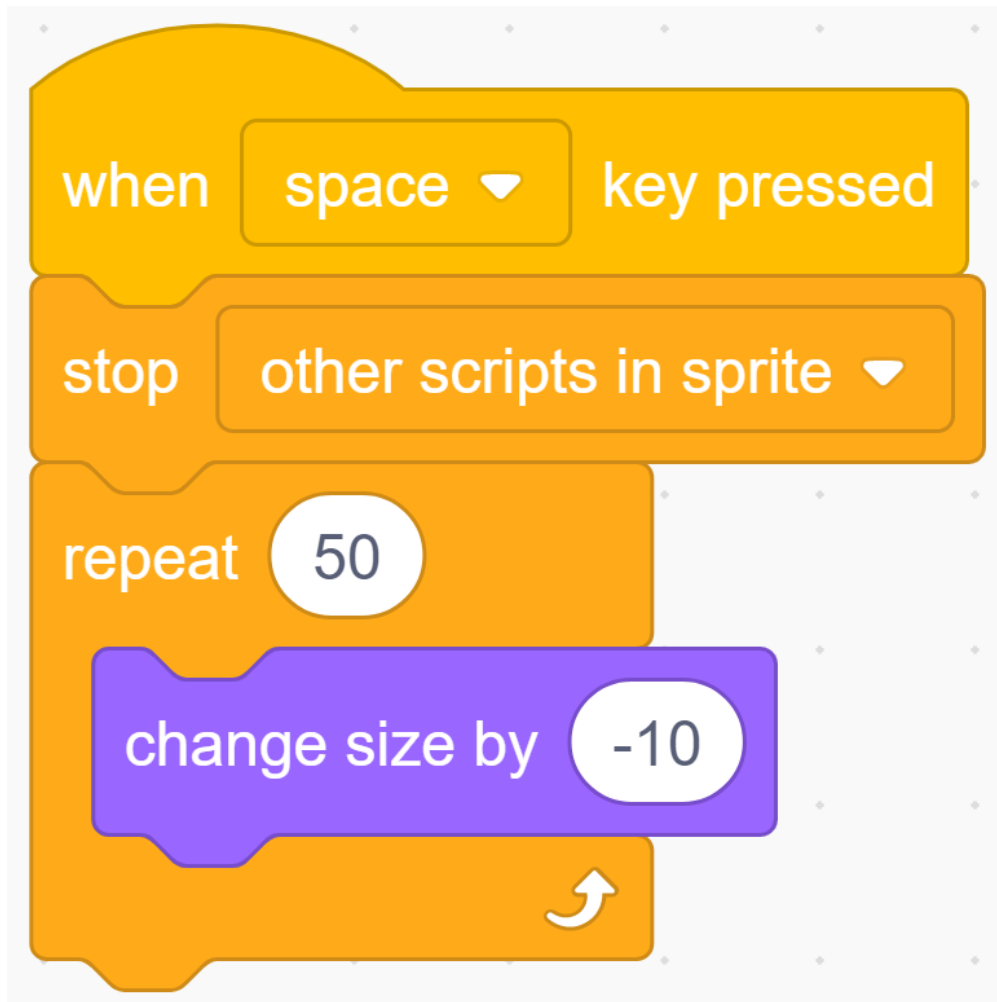

Click the green flag to try the effect!

Calculate the score!

Then we need to establish a scoring mechanism. Shooting different color circles will get different scores. The closer to the bullseye, the higher the score.

For example, a shot in the red area can score 200 points. Let's use the **Touching Color** block to judge. This block has a color picker, and we use it to pick up the red color on the target.

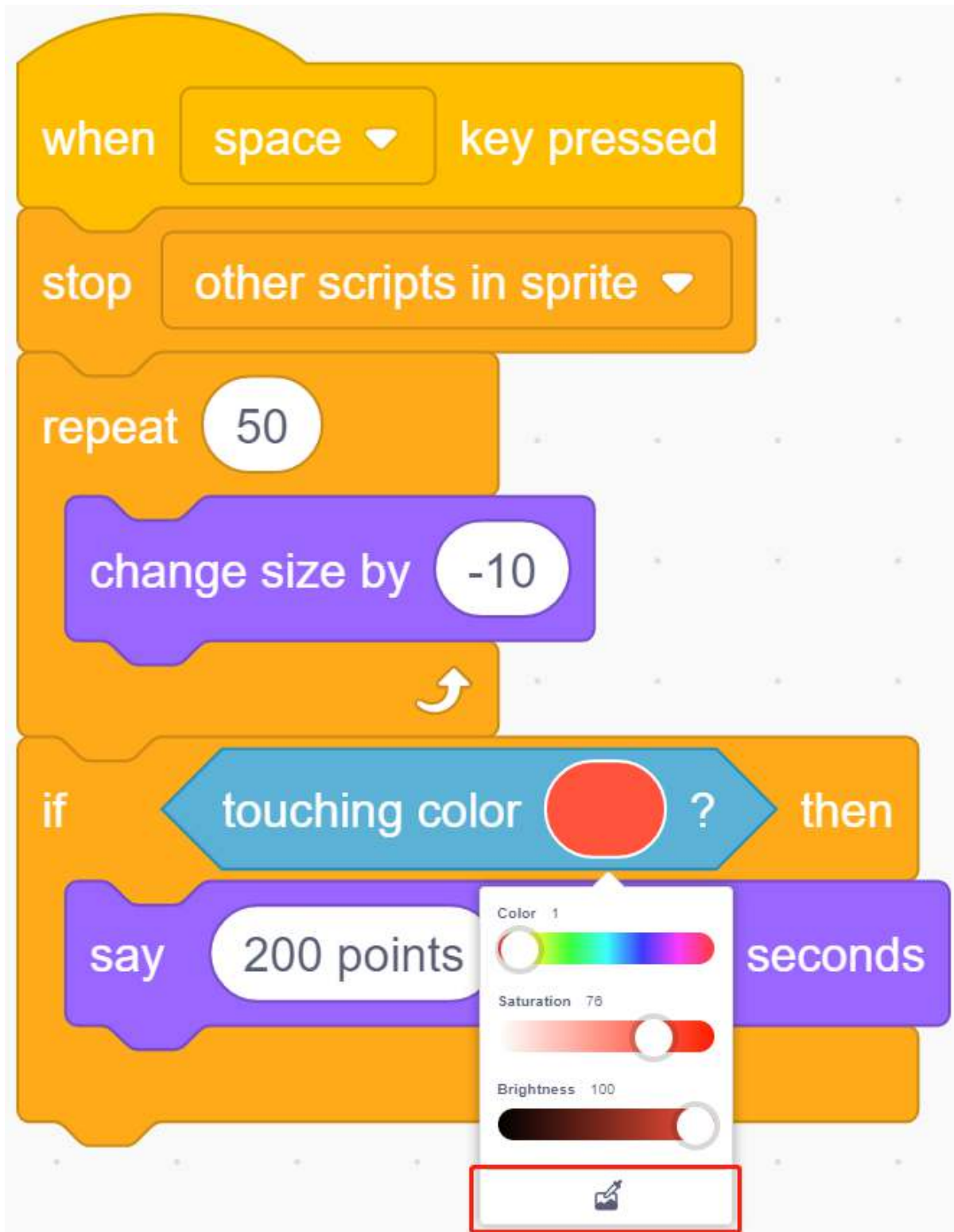

Use the same method to set corresponding scores for different color circles.

```
when space key pressed
stop other scripts in sprite
repeat 50
  change size by -10
if touching color yellow ? then
  say 300 points for 2 seconds
if touching color red ? then
  say 200 points for 2 seconds
if touching color blue ? then
  say 150 points for 2 seconds
if touching color black ? then
  say 100 points for 2 seconds
if touching color grey ? then
  say 50 points for 2 seconds
broadcast cross hair
```

Challenge

I believe that you will be smart enough to program and implement this game soon. Next, we will add some challenges to enrich our game content.

- In a game, you can shoot three rounds and then calculate the total score.

5.7.6 Hit the Magic Fish

Description

Before the project Starts, I will tell you the story of a magic fish. In the vast underwater world, there is a magical magic fish. When you hit it with a Starfish, it will become another fish.

Today we use the scratch stage to simulate an underwater world, and then add the Star sprite and fish sprite to make a “hit the magic fish” mini game.

Click on the green flag to Start. Press the space bar to launch the Starfish.

Or click [Hit the magic fish](#), and then learn online tutorial on the Scratch official website.

Required Components

- A Screen
- Scratch 3 (either online or offline)

You Will Learn

- Let the sprite bounce when it hits the edge of the stage.
- Change the coordinates to make the sprite move.
- Make a timer.
- Use the broadcast to tell the sprite what happened.

Lesson Guide

This fish is swimming.

Added **Fish** sprite, **Star** sprite and **Underwater1** backdrop image.

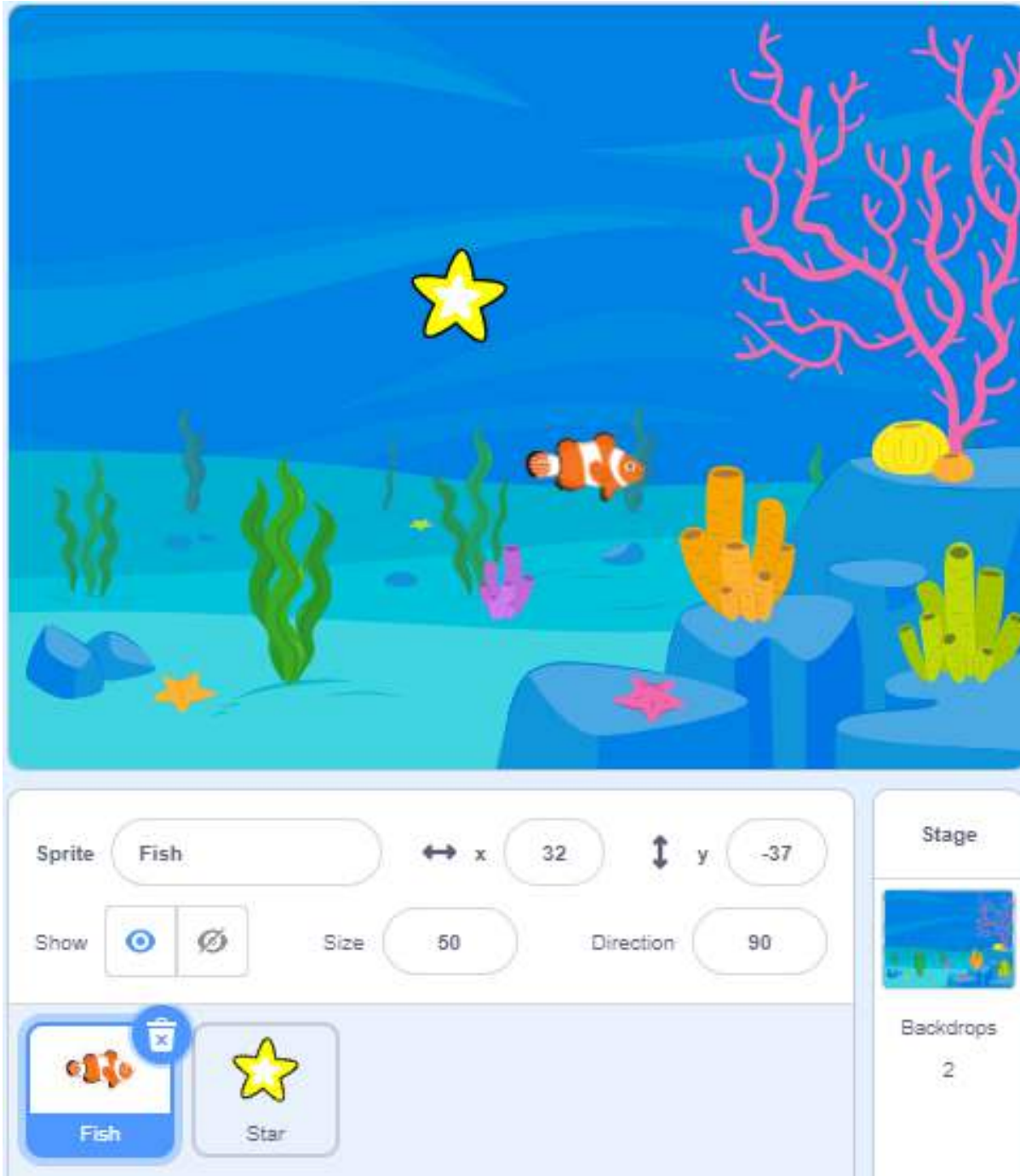

Let the Fish appear at the coordinates (-240,120), and then let it swim left and right.

Use the **if on edge, bounce** block to make the Fish sprite fold back from the edge. When it hits the wall, it will fold back in the opposite direction to the original.

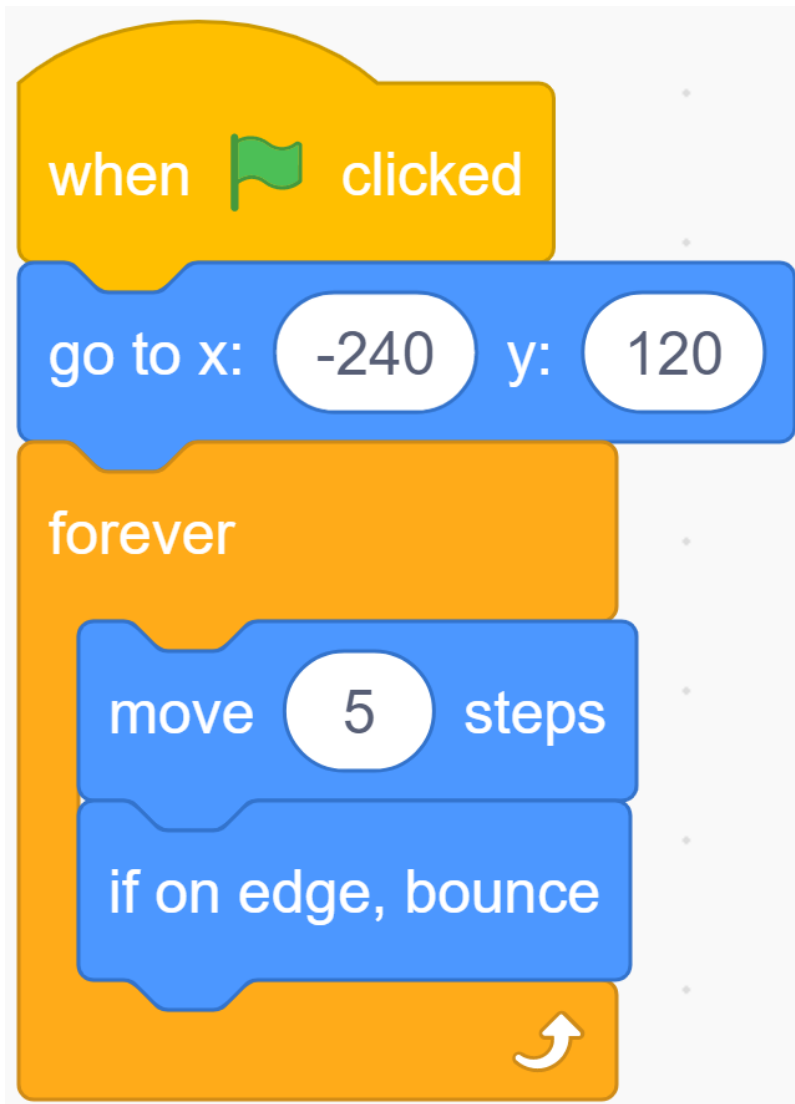

This Star is rising.

Let the Star appear at (0,-120). If we press the ← or → key on the keyboard, it will go left and right.

We use the **key ... pressed** block to determine the keyboard, and use **change x by ...** to move the sprite.

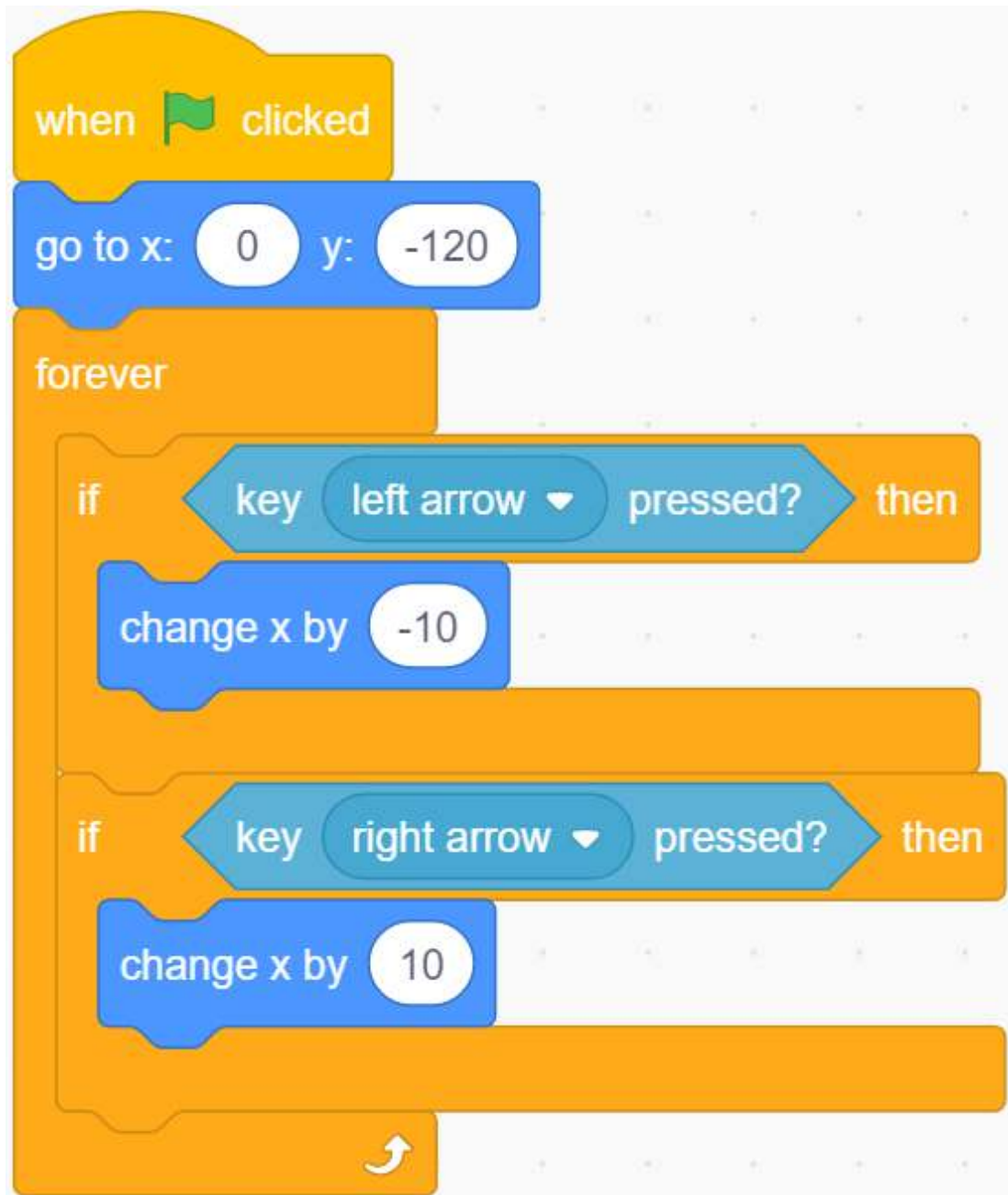

Next, launch the Star. If the space bar is pressed, the y coordinate value of the Star sprite will increase, and the Star sprite will rise.

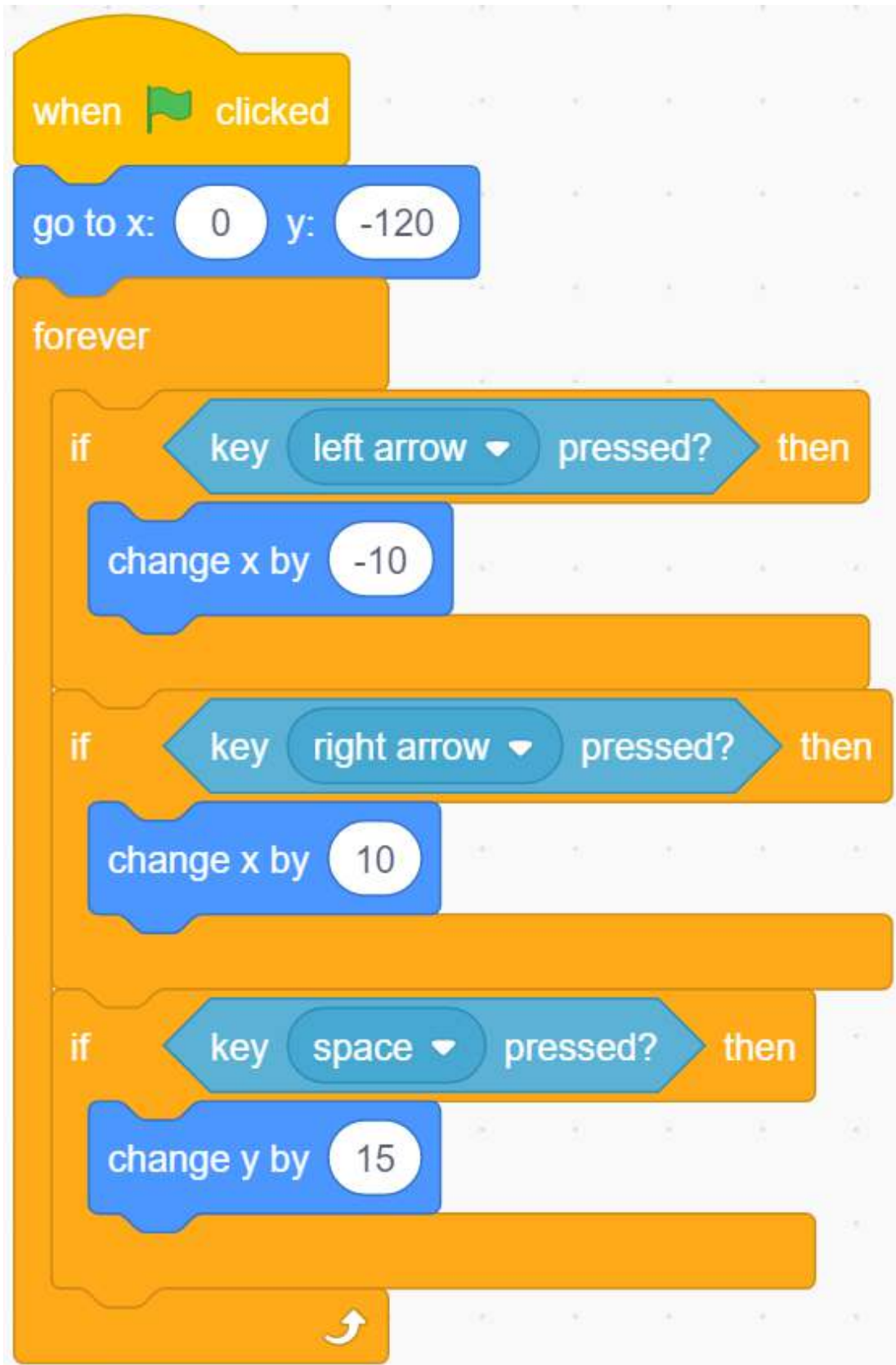

Something is wrong. The Star sprite should continue to rise until it reaches the height of the Fish sprite (remember?

The y coordinate we set for Fish is 120) and then return.

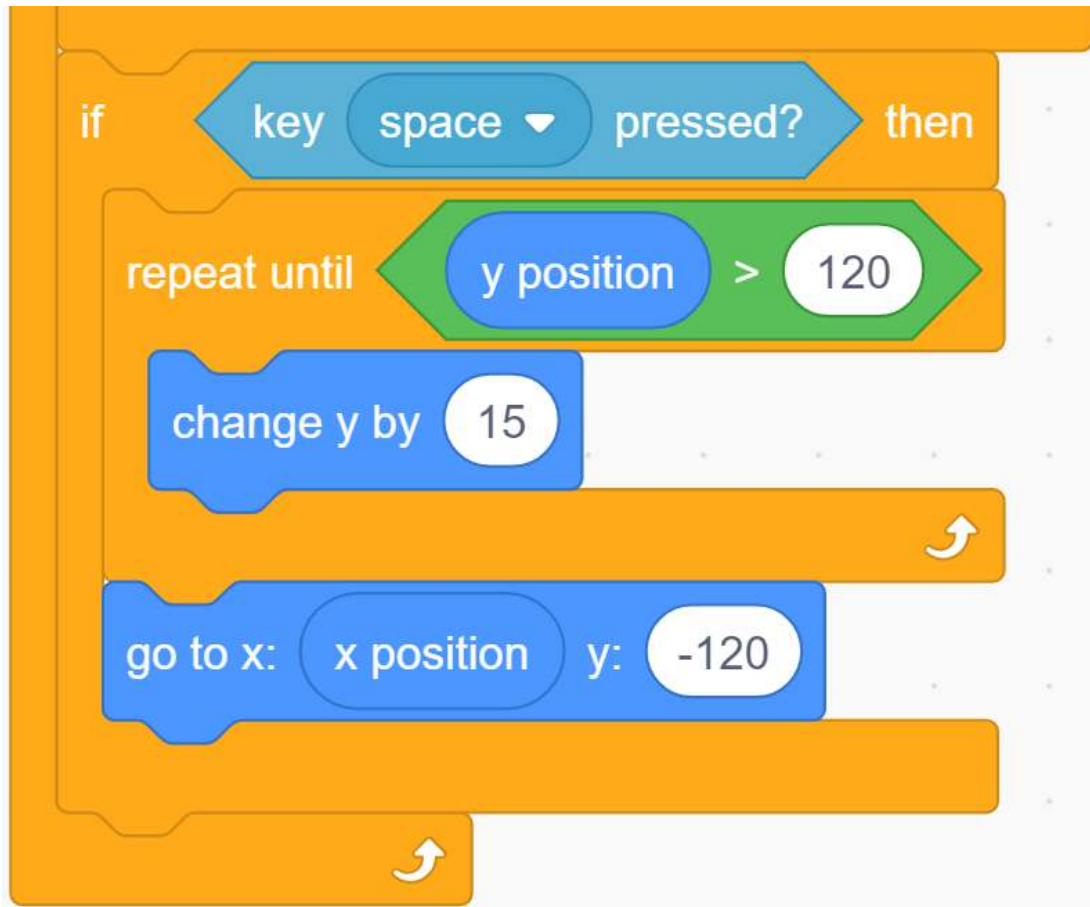

Now it looks better.

Fish hit by a Star.

After the Star rises, before returning to the bottom, you need to use a **touch...** block to determine whether it hits the Fish.

When the Star sprite hits the Fish sprite, we need to tell the Fish sprite about this and let it do the corresponding behavior-change its shape.

We set up a "Hit" broadcast. This broadcast will tell the entire program that something called "Hit" has happened. All sprite and even the backdrop can hear this broadcast and respond accordingly.

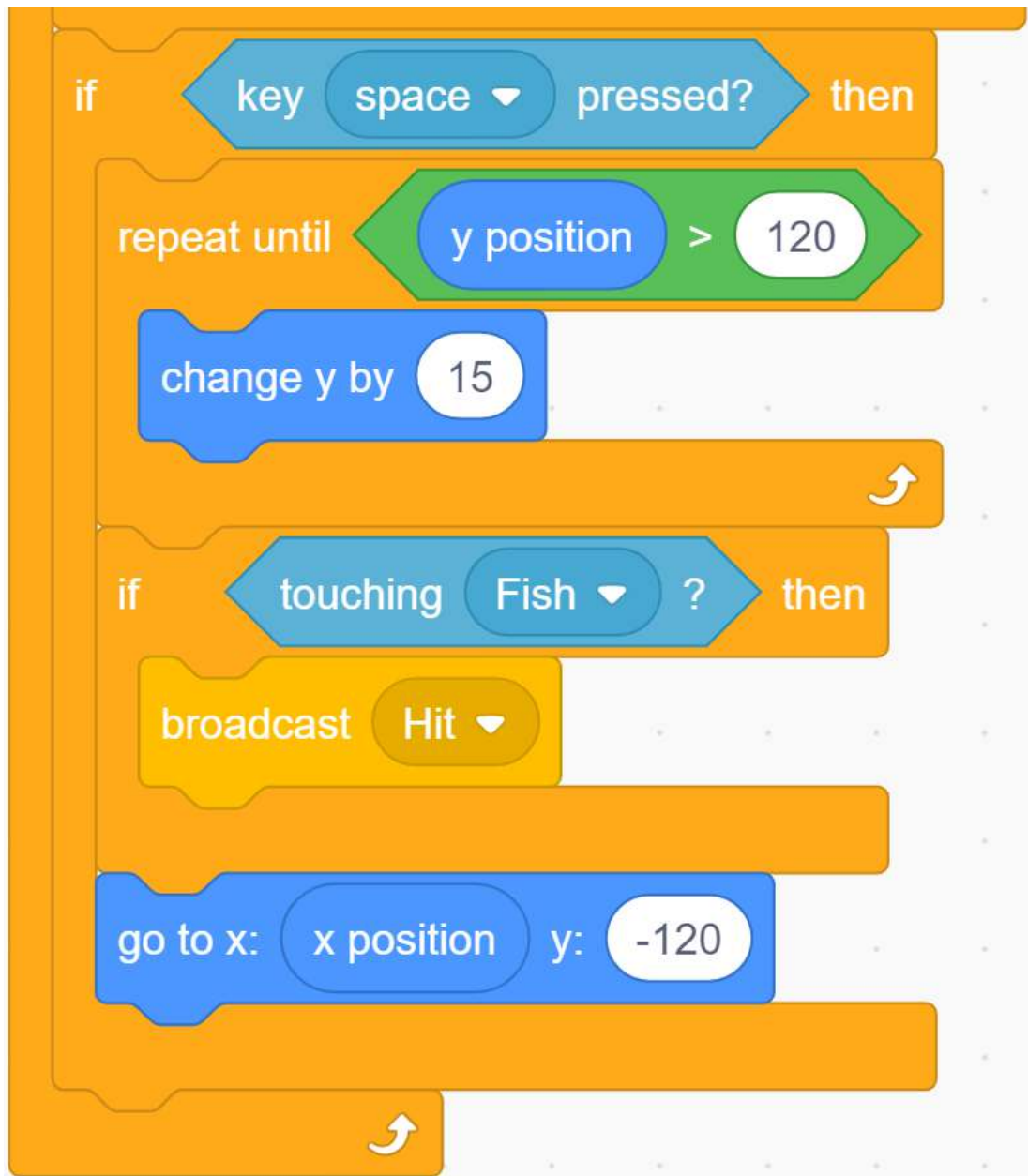

Back to the programming interface of the Fish sprite, use a **when I receive...** block to receive the “Hit” broadcast, and then use **Next costume** to change your form.

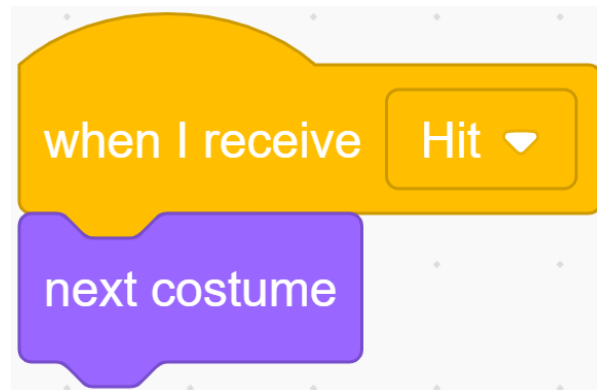

Calculate the score!

To make the game more interesting! Add a scoring mechanism. When you click the green flag, the score will be reset to zero. When a “hit” event occurs, the score will increase by 1.

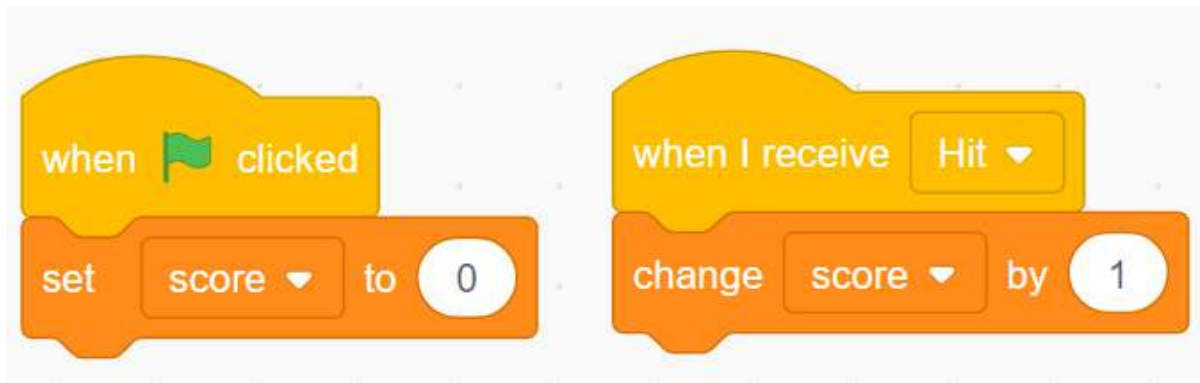

Note: This does not involve the calculation of sprites and backdrops. We tend to put such codes in backdrops.

Countdown!

Add a time mechanism. When the green flag is clicked, the timer is set to 30s, and then decreases by 1 every second until the event is reset to zero to end the game.

But if you hear the “Hit” broadcast, let the timer increase by one to increase the game time.

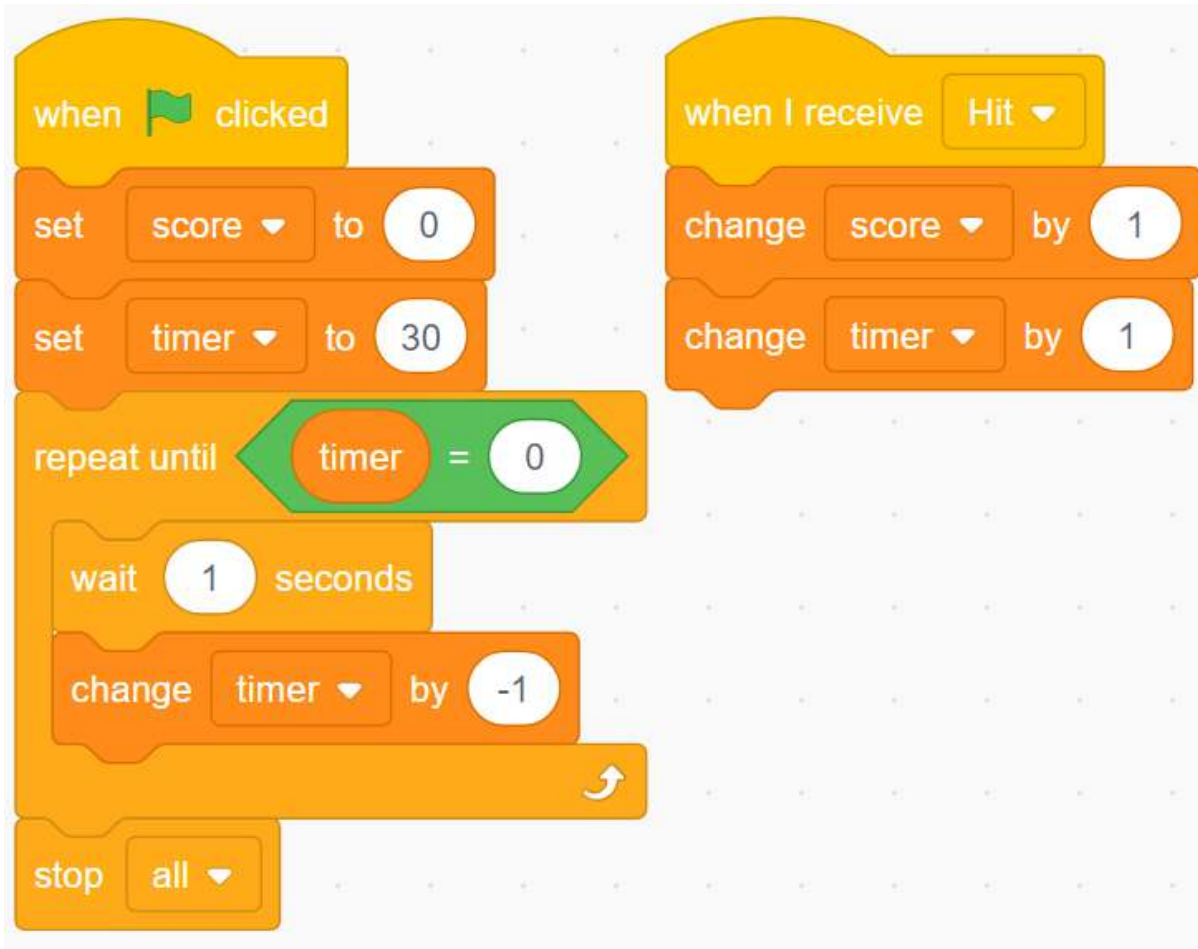

Challenge

I believe that you will be smart enough to program and implement this game soon. Next, we will add some challenges to enrich our game content.

- Added several different magic fish.
- One will get double points
- One will reduce game time
- One will change the background

5.7.7 Binary Game

Description

Do you understand binary numbers? binary is a number system widely used in computing technology, so understanding binary numbers is an important step for understanding the computer world.

Click on the green flag to start. A random number will appear in the middle of the screen, and you need to know the corresponding binary number. For example, 5, the corresponding Binary number should be 0101, press the bear's paw on the right to confirm. If it is correct, the score will be increased by 1.

Or click [Binary Game](#), and then learn online tutorial on the Scratch official website.

Required Components

- A Screen
- Scratch 3 (either online or offline)

You Will Learn

- Understand binary numbers.
- Convert binary numbers to decimal numbers.

Lesson Guide

Arrange a small binary abacus at the bottom of the screen.

First, we delete the previous sprite. Upload the **Zero.png** file and **Enter.png** file in the sprite list, you have downloaded them from [github - 7-diy-touch-screen](#) before.

Then we upload the **One.png** file in the **Costumes** option of the **Zero** sprite, so that the **Zero** sprite has **Zero** costume and **One** costume.

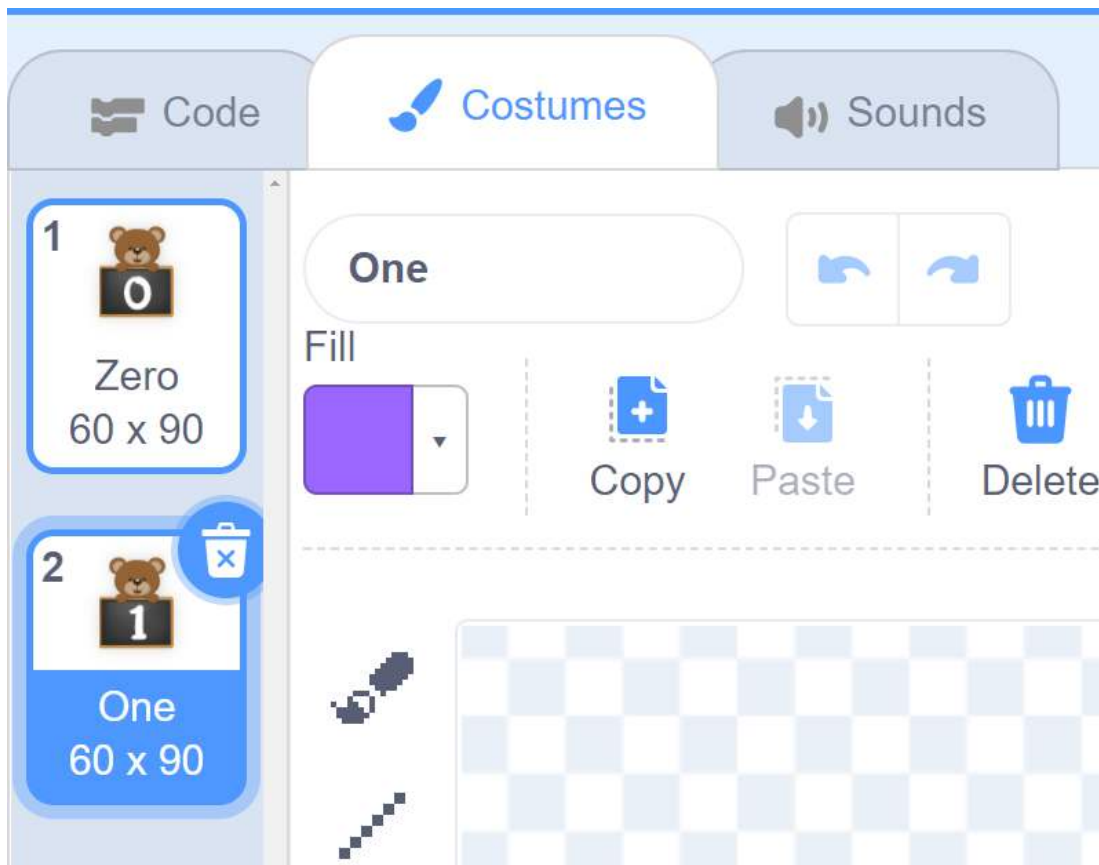

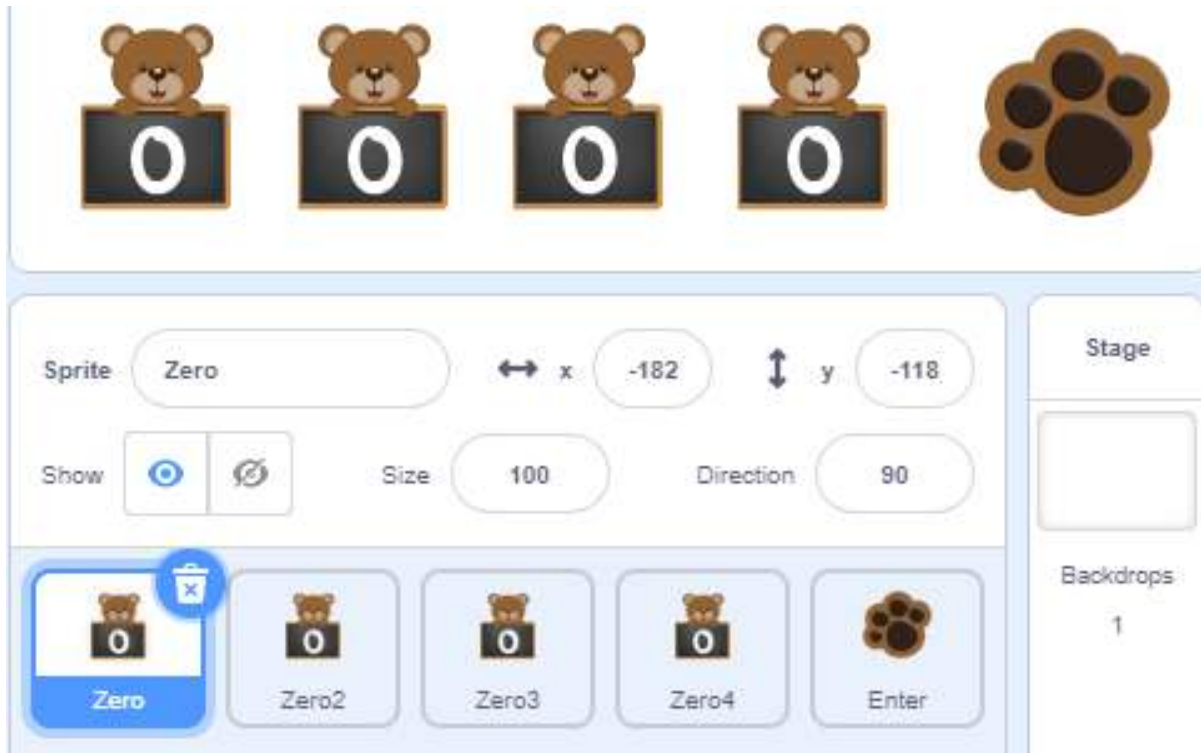

Then we copy the **Zero** sprite with the right mouse button, and there will be 3 new **Zero** sprites in the stage area.

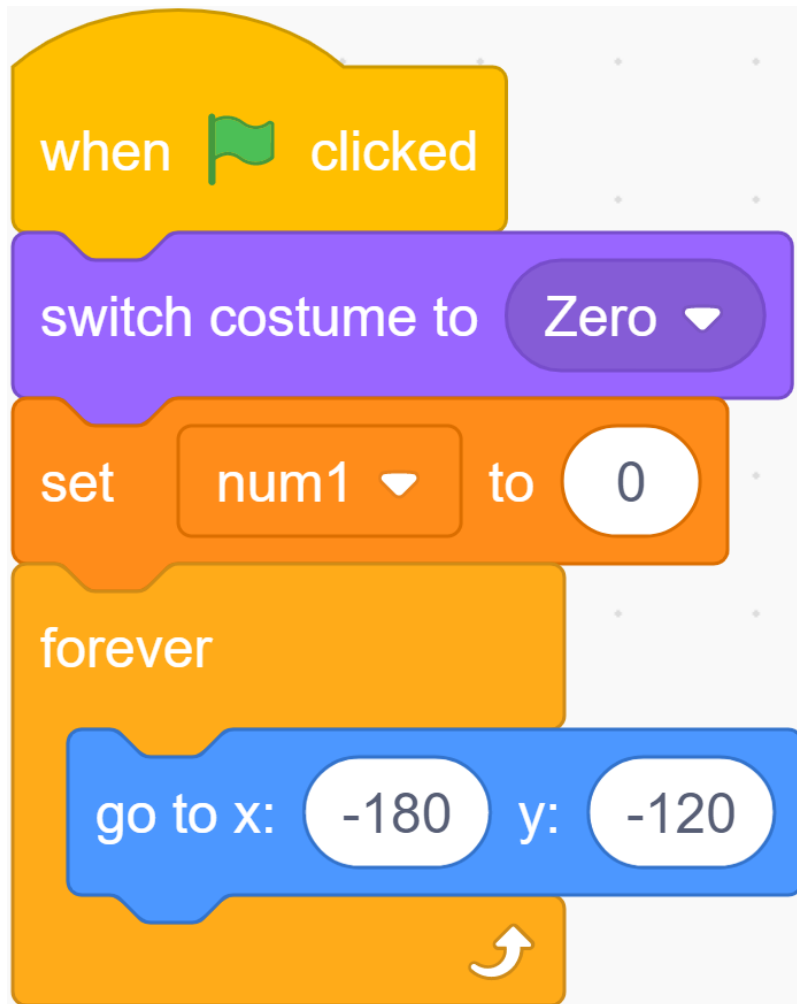

Set the default costume of the four sprites to Zero, record with the variables “num1”, “num2”, “num3”, and “num4” respectively, and initialize the positions of the four sprites.

The program in the figure below is the program of the Zero sprite. The other three Zero sprites modify the variable names and increase the X coordinate by 80 to make the effect arranged in order from left to right.



When we click the  sign in front of the variable, the variable will disappear from the stage.

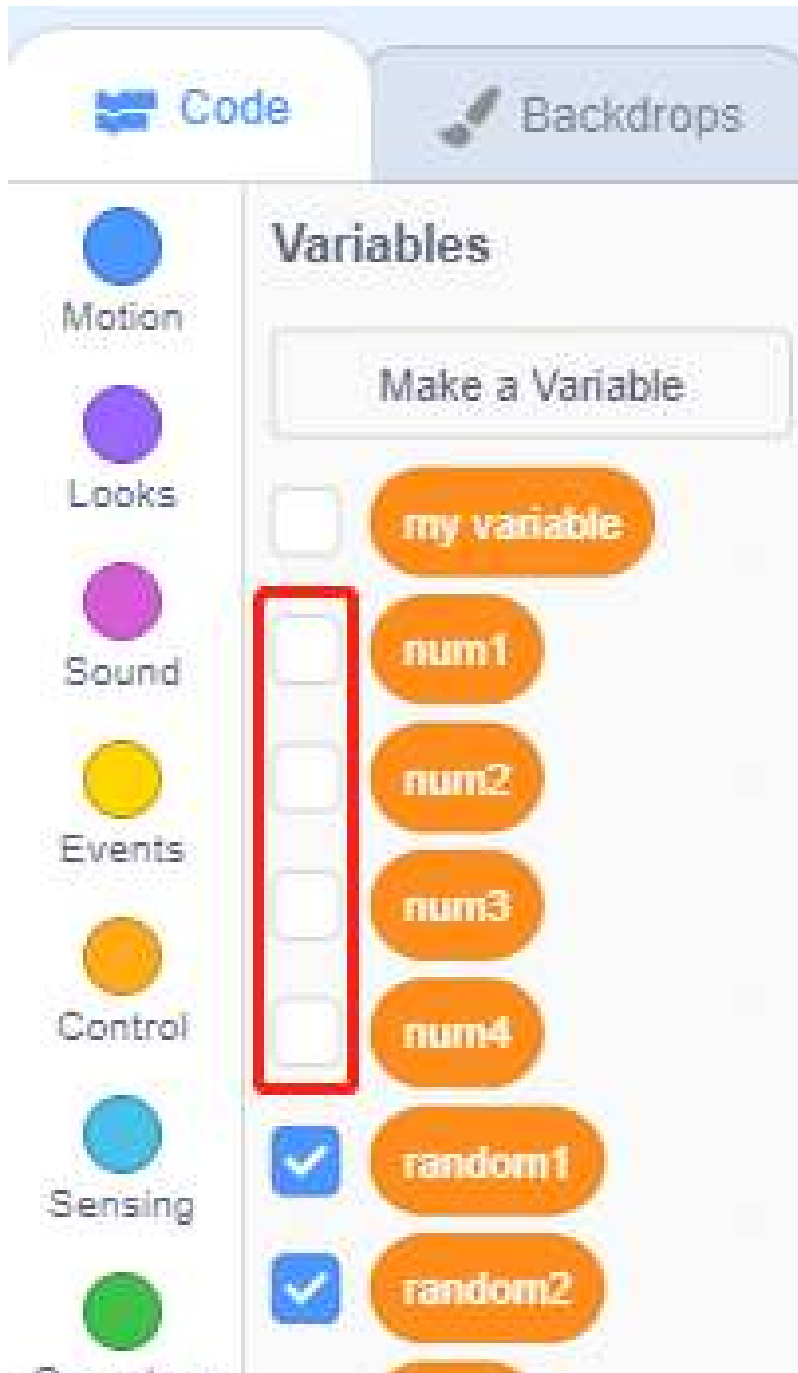

Change the shape by clicking and record the binary value.

If you click the **Zero** sprite, it will switch its costume to the next costume, and switch the value of the variable num1, if num1 = 0, change num1 to 1.

In this way, the num1 variable can record the value on the blackboard in real time every time the Zero sprite switches costume.

Copy the program for the remaining three **Zero** sprites and modify the variable names.

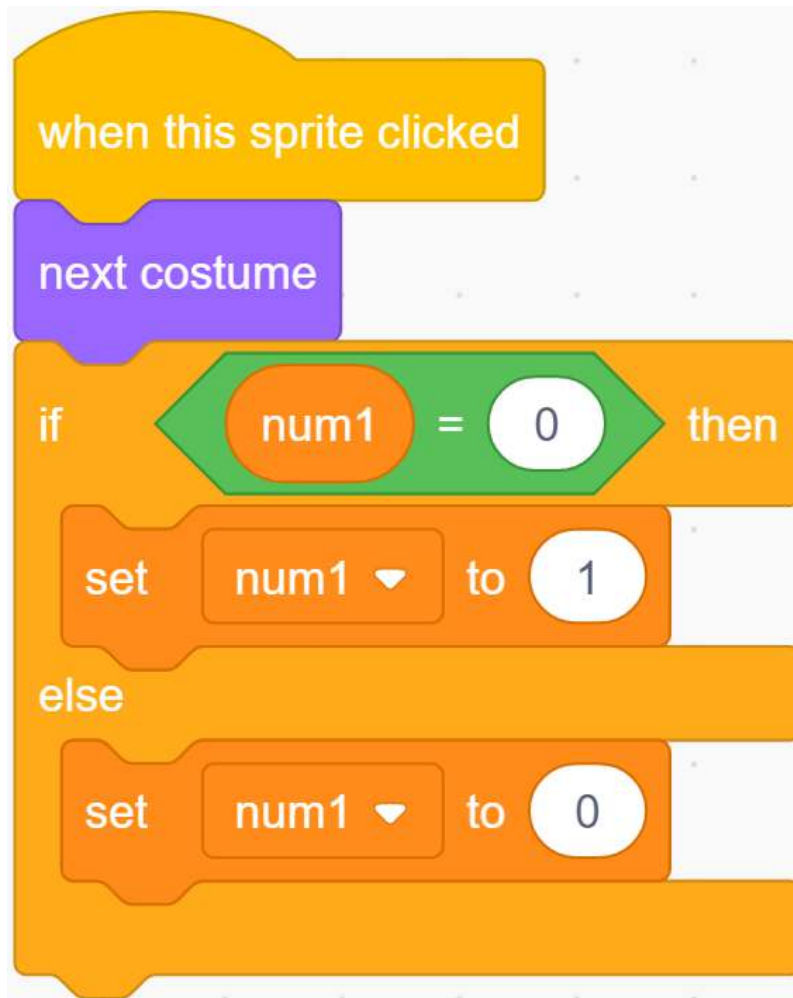

Conversion of binary numbers and decimal numbers.

Before programming the Enter sprite, let's first understand the [Binary number](#).

A binary number is a number expressed in the base-2 numeral system or binary numeral system, which uses only two symbols: typically "0" (zero) and "1" (one).

How to convert binary to decimal?

For binary number with n digits:

```
dn-1 ... d3 d2 d1 d0
```

The decimal number is equal to the sum of binary digits (d_n) times their power of 2 (2^n):

```
decimal = d0×2^0 + d1×2^1 + d2×2^2 + ...
```

If binary is 1000, the corresponding decimal should be $1 \times 2^3 + 0 \times 2^2 + 0 \times 2^1 + 0 \times 2^0 = 8$

So, what is the decimal number of 1010? $1 \times 2^3 + 0 \times 2^2 + 1 \times 2^1 + 0 \times 2^0 = 10$.

Programming the Backdrop

When the game starts, a random integer between 1-16 appears in the middle of our screen as a decimal number that needs to be converted by binary, and it is stored in the variable random.

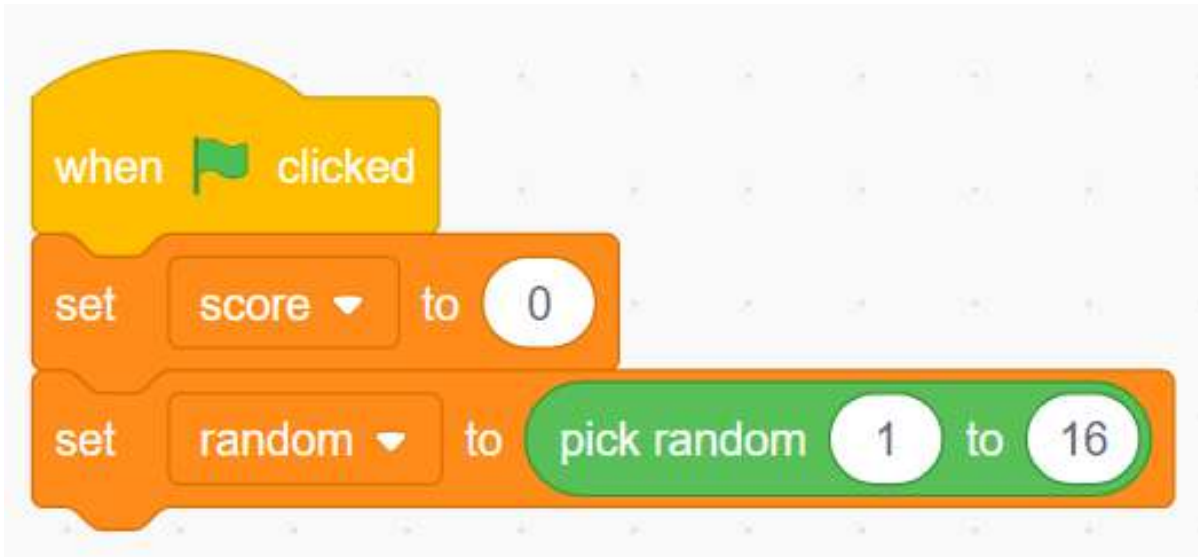

Whether we receive a “right” result or a “wrong” result, we have to regenerate the random number and proceed to the next round of the game.

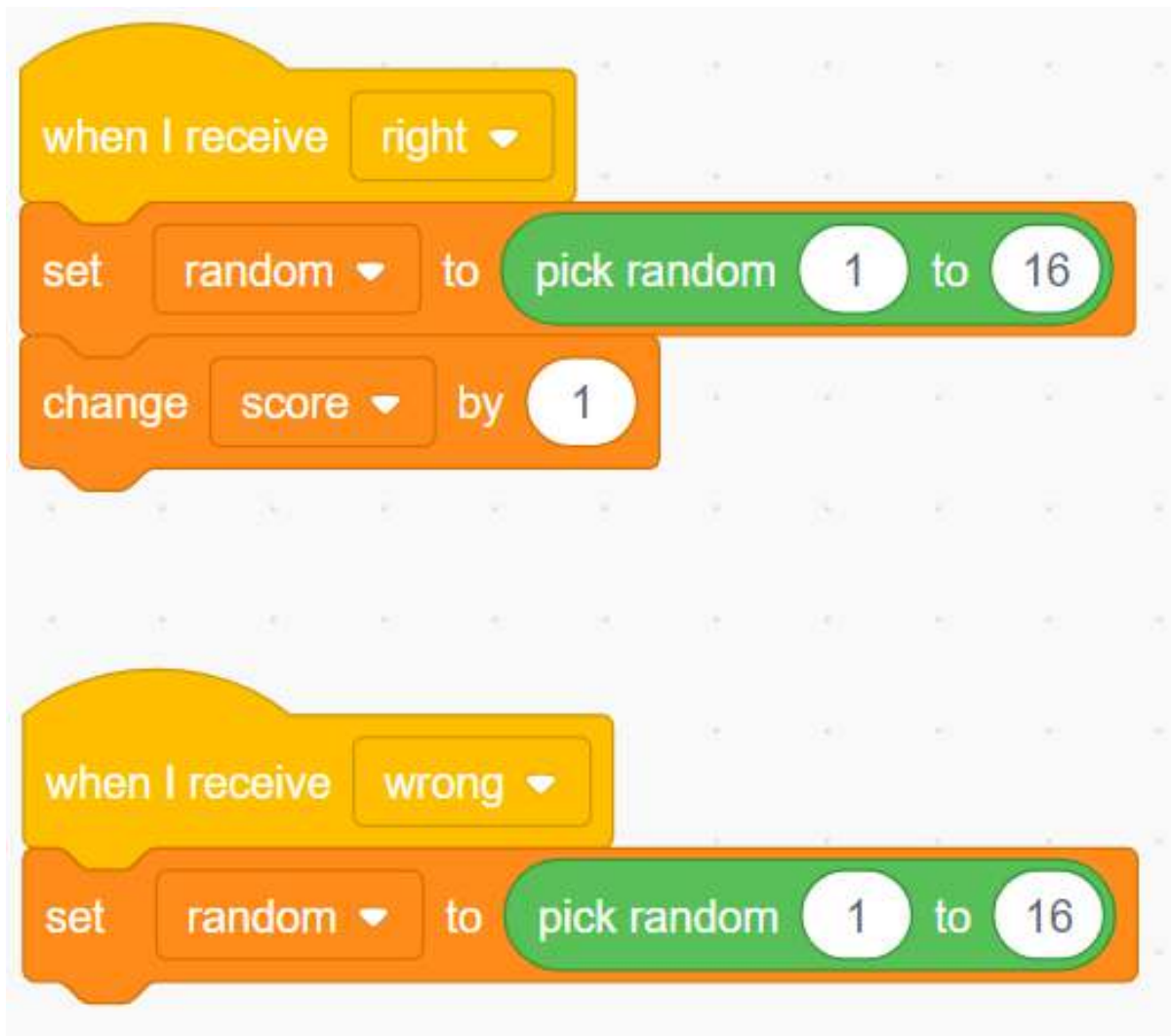

Programming the Enter Sprite

After you understand the conversion of binary numbers and decimal numbers, let's program the Enter sprite.

First, we create a result variable, when the Enter sprite is clicked, We convert the binary number composed of the num1 variable, num2 variable, num3 variable and num4 variable into a decimal number, and save the result in the result variable.



Then use the result variable to compare the value of the random variable. If they are equal, we broadcast a “right” message, otherwise we broadcast a “wrong” message.

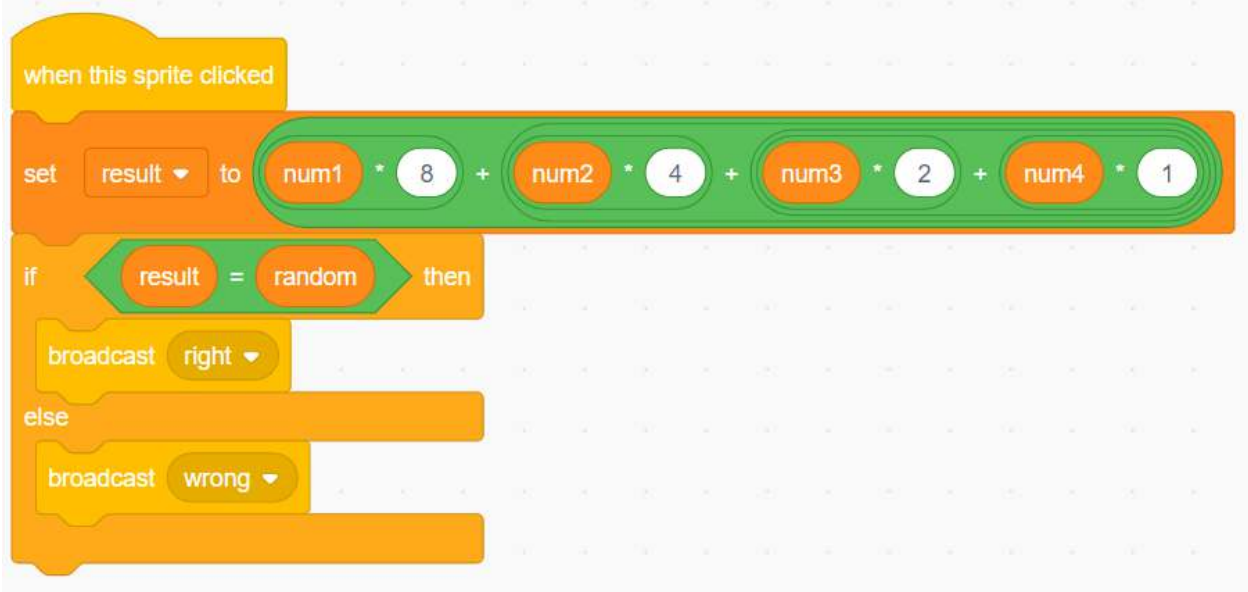

Now, click on the green flag above the stage area to start the game and explore the magical binary!

Challenge

I believe that you will be smart enough to program and implement this game soon. Next, we will add some challenges to enrich our game content.

- Add a Zero sprite to convert random integers between 1-32.
- When you click on the Zero sprite, a “Pop” sound effect will be emitted.
- 1 point will be deducted for incorrect answers!

5.7.8 Flappy Parrot

Description

Today we made the parrot Devin avoid the trees for food.

Click on the green flag to start.

Or click [Flappy Parrot](#), and then learn online tutorial on the Scratch official website.

Required Components

- A Screen
- Scratch 3 (either online or offline)

You Will Learn

- Add more costumes to sprites and let them change their appearance
- Logical Operation
- Determine if the sprites are touching each other

Lesson Guide

Arrange the parrot and background image

First, we delete the default sprites and add Parrot sprites and Blue Sky backdrop. Change the size of the Parrot sprite to 20.



Upload the Trees sprite, select the Upload Sprite option, find the “Trees.png” file, and upload it.

Click Costumes, and then click the “Upload Costume” option to upload Trees2.png, Trees3.png, Trees4.png, and Trees5.png.

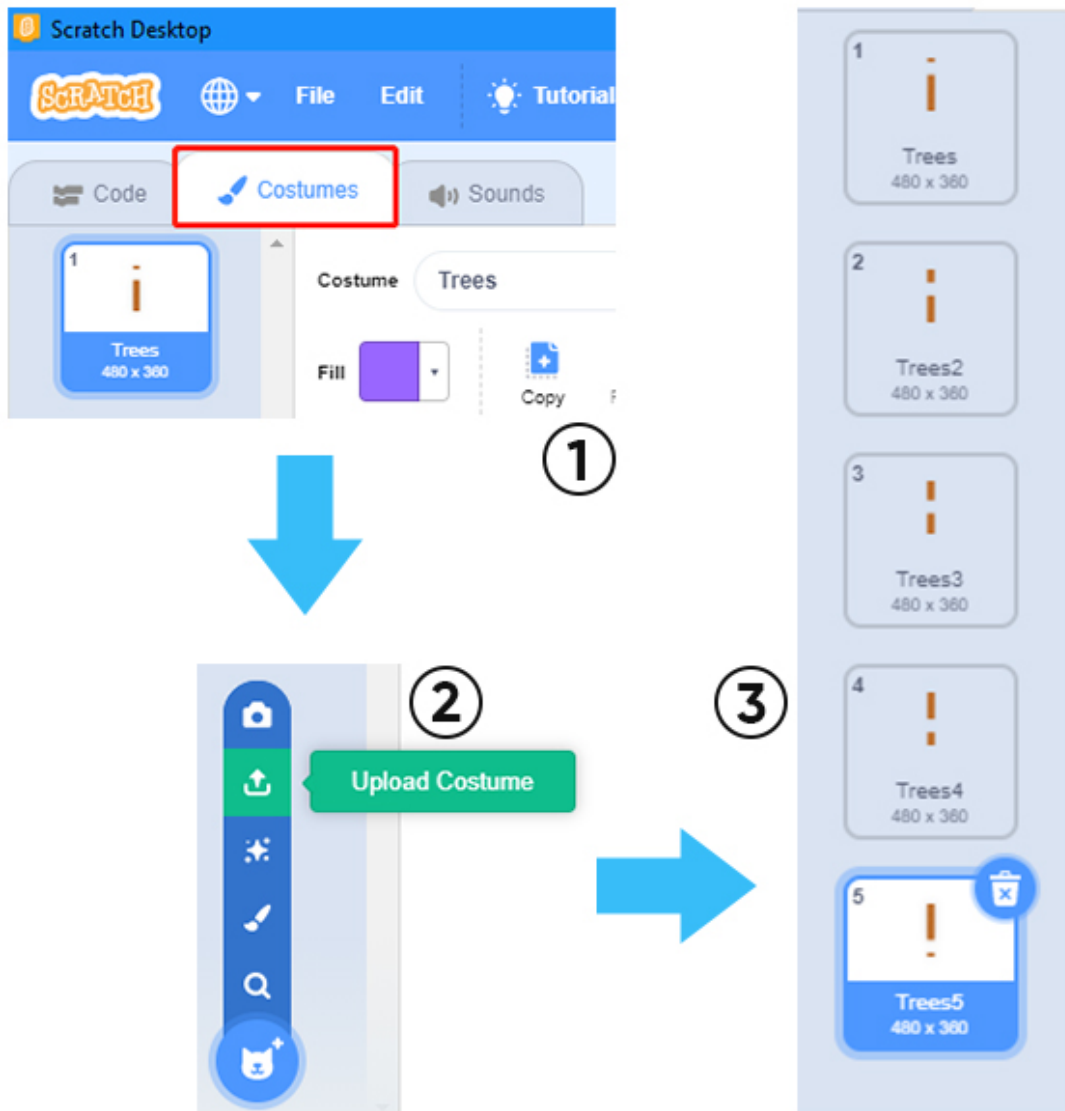

Copy out the second Trees.

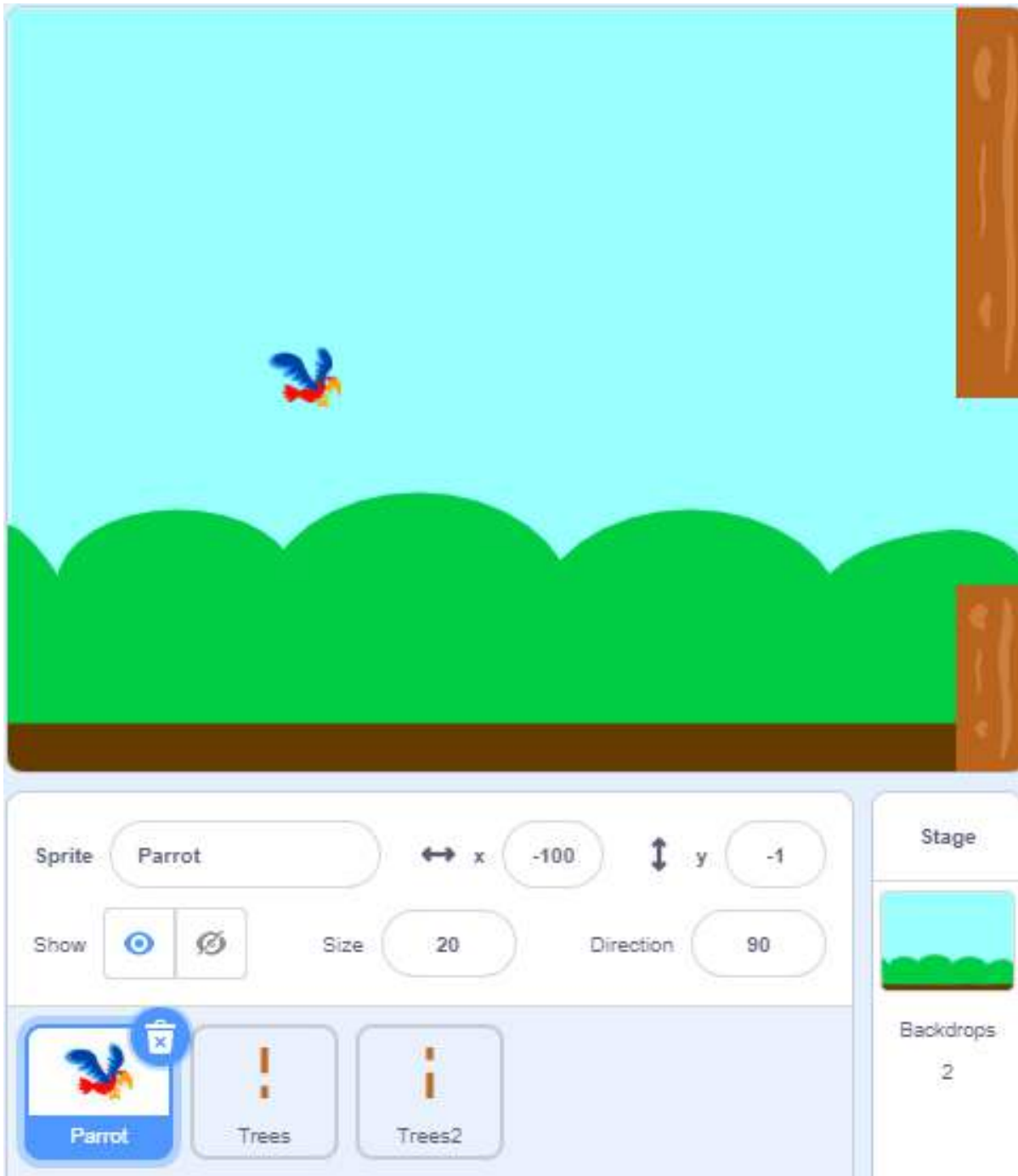

Let the Parrot sprite fly on the stage

Parrot stayed still, and the Trees and Trees2 sprites kept moving to the left, so it looked like the Parrot sprites were flying on the stage!

Set the initial position and movement of the Trees sprite so that it can reach the far left from the far right of the stage. Then, randomly changing costumes reappear on the far right side of the stage.

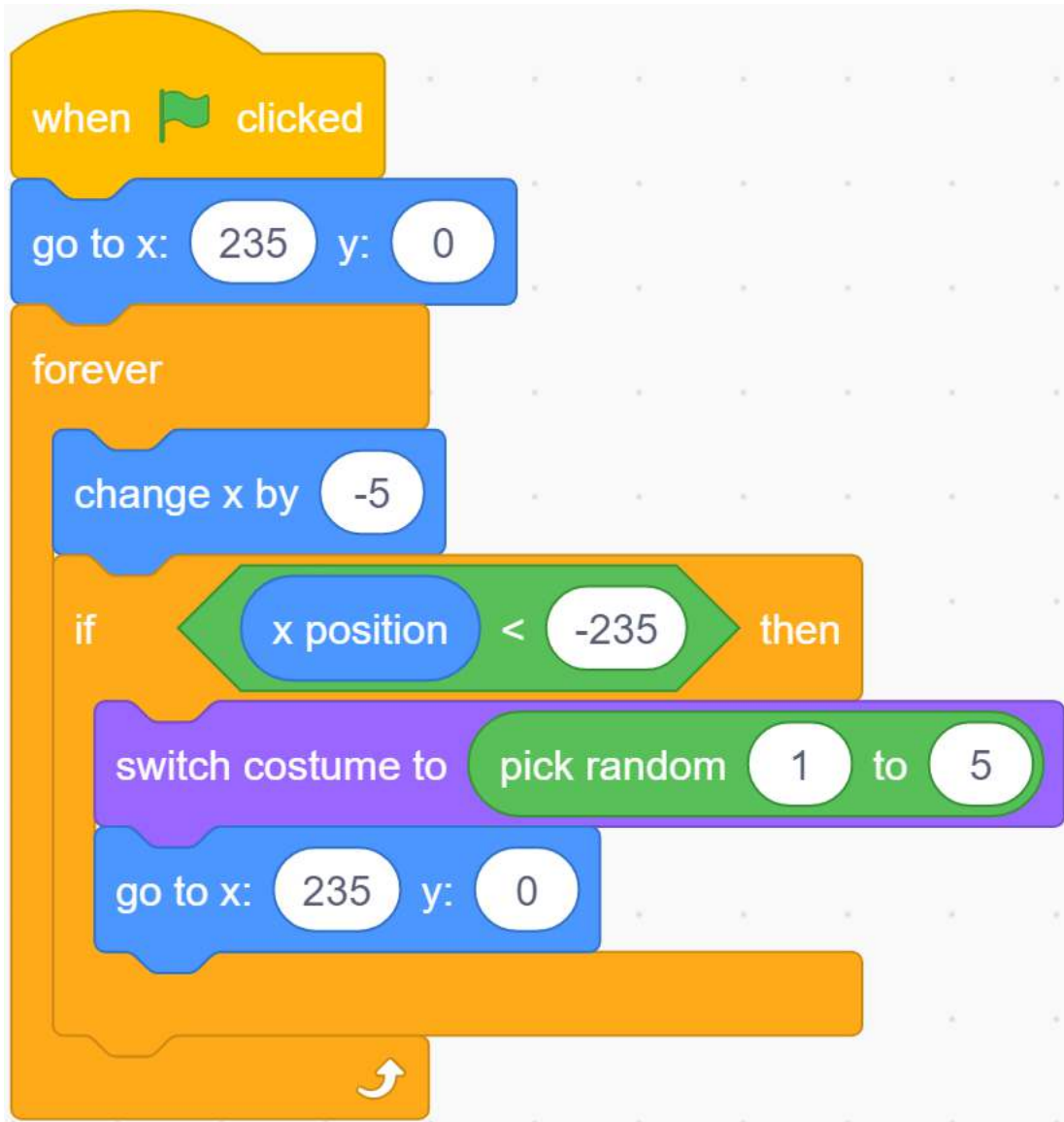

The code of the Trees2 sprite is almost the same as the Trees sprite, the only difference is that it hides for 1.5 seconds at the beginning.

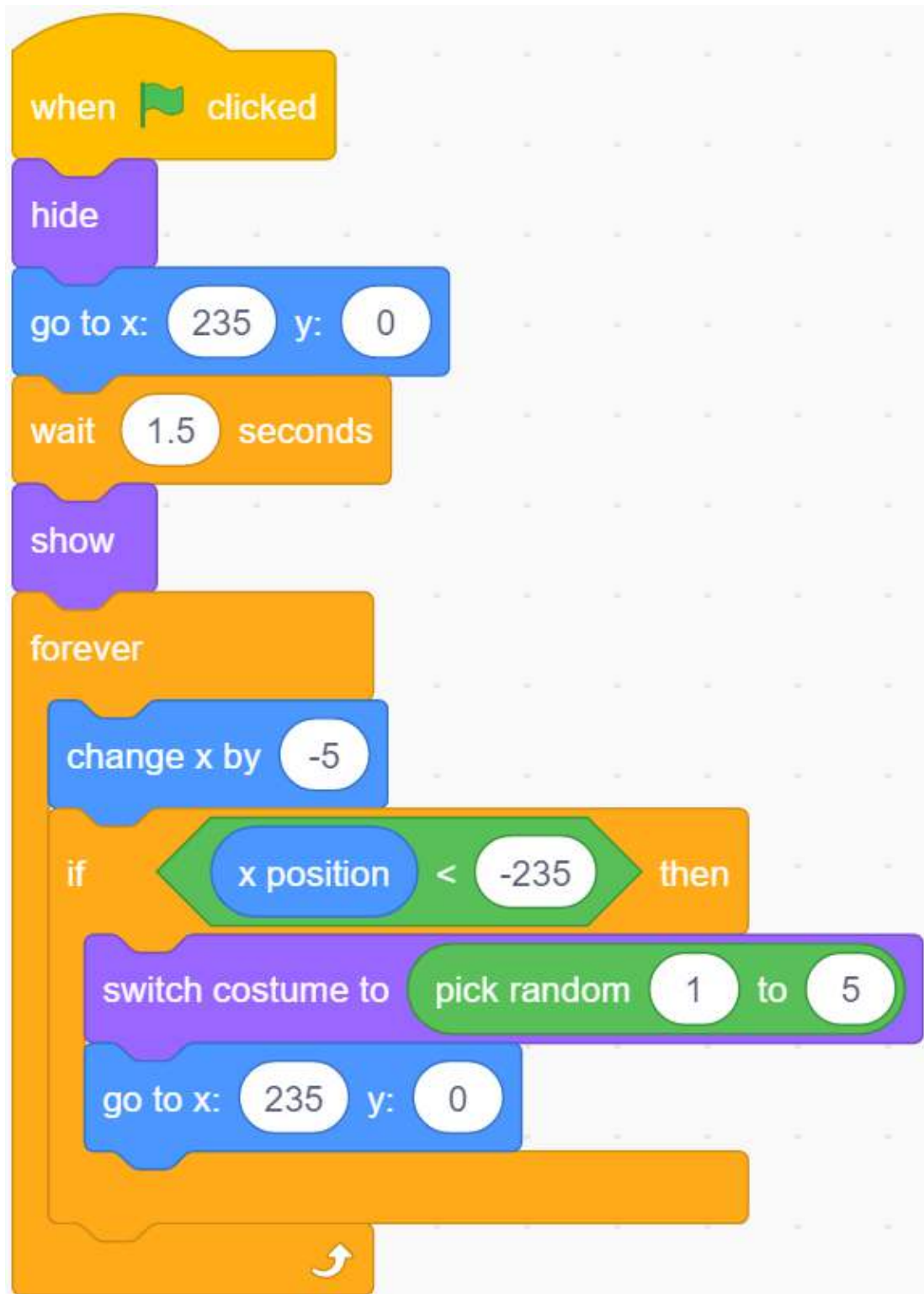

Now, click on the green flag to see the effect of this flight... Very good, the Parrot sprite seems to be flying to the right side of the stage.

Let the space button control Parrot to fly

When the game starts, Parrot will continue to drop down, that is, the y coordinate will continue to decrease. When we press the space button, the y coordinate of Parrot will increase.

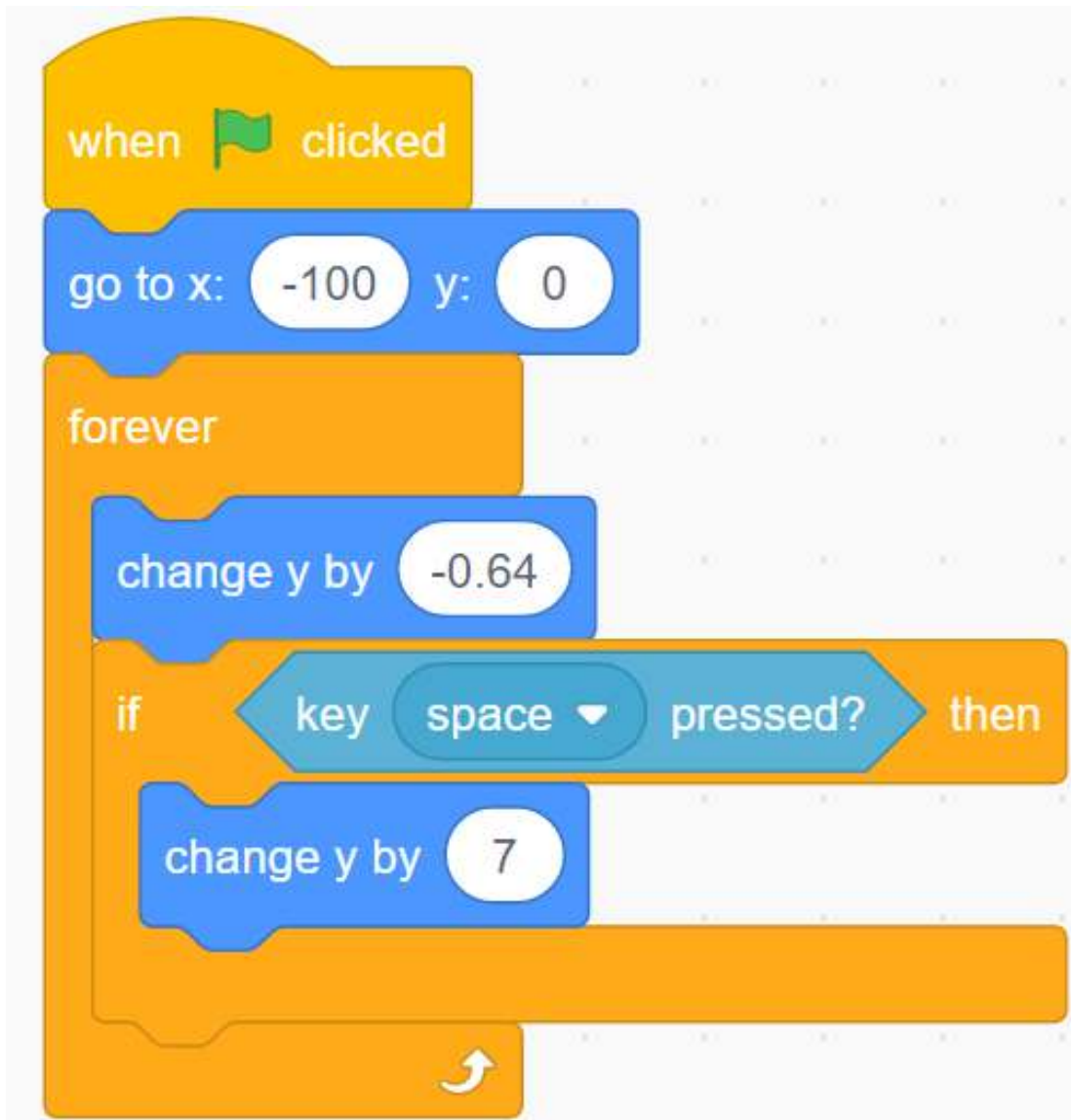

Constantly increase the speed of Parrot falling through variables

Parrot drop is a bit slow, we add flight variables to make Parrot drop more and more!

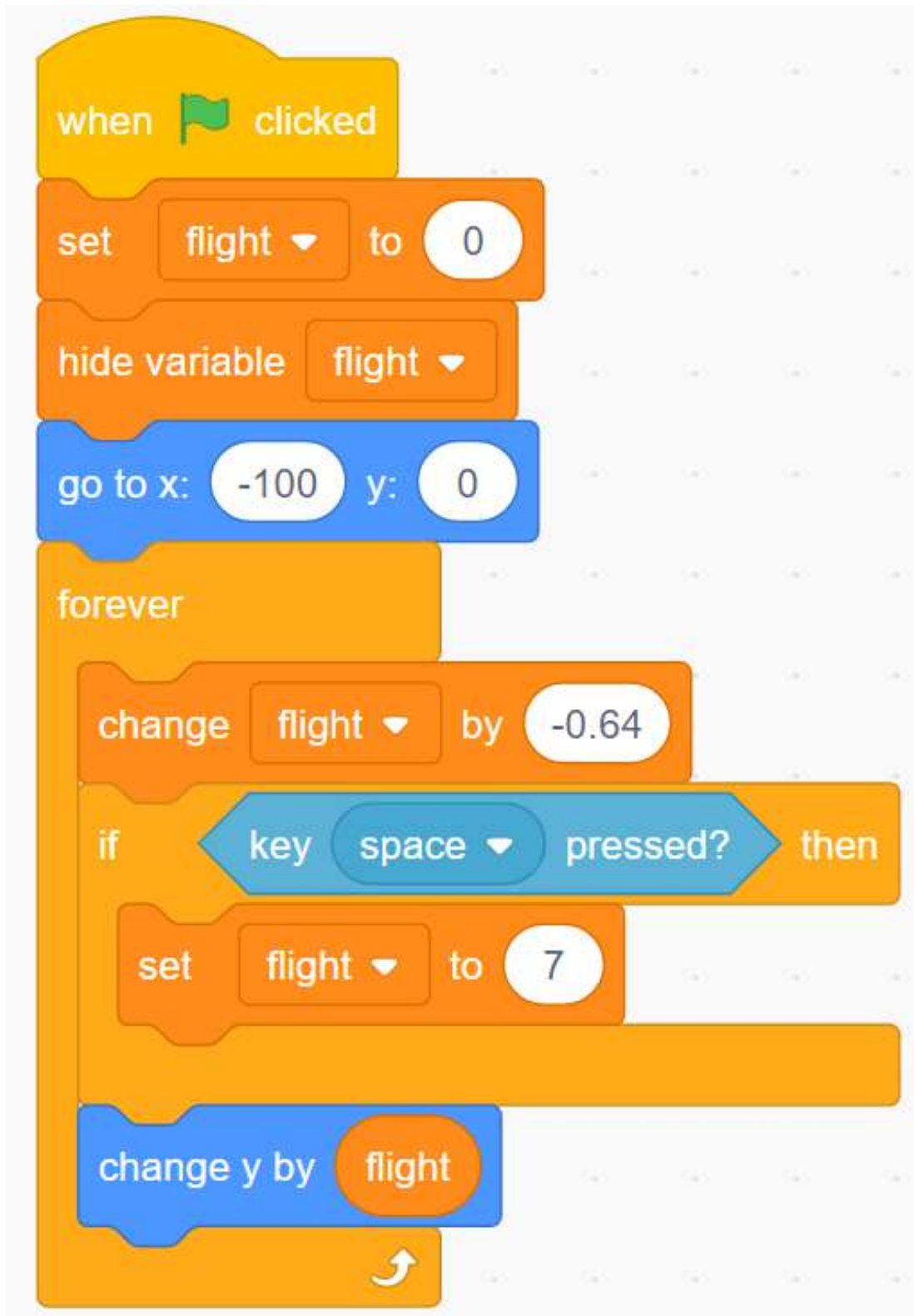

Change the costume so that Parrot has flight animation

When we press the Space button, Parrot's clothing switches to Parrot-b.



Calculate the score!

Create a new score variable. When the Trees and Trees2 sprites move to the right side of the Parrot sprite, it means that Parrot has crossed the Trees and Trees2. At this time, we will add score+1. In order to avoid always adding points, we need to add it after score+1 Wait 1 second for the code. (This code is required in both Trees and Trees2 sprites!)

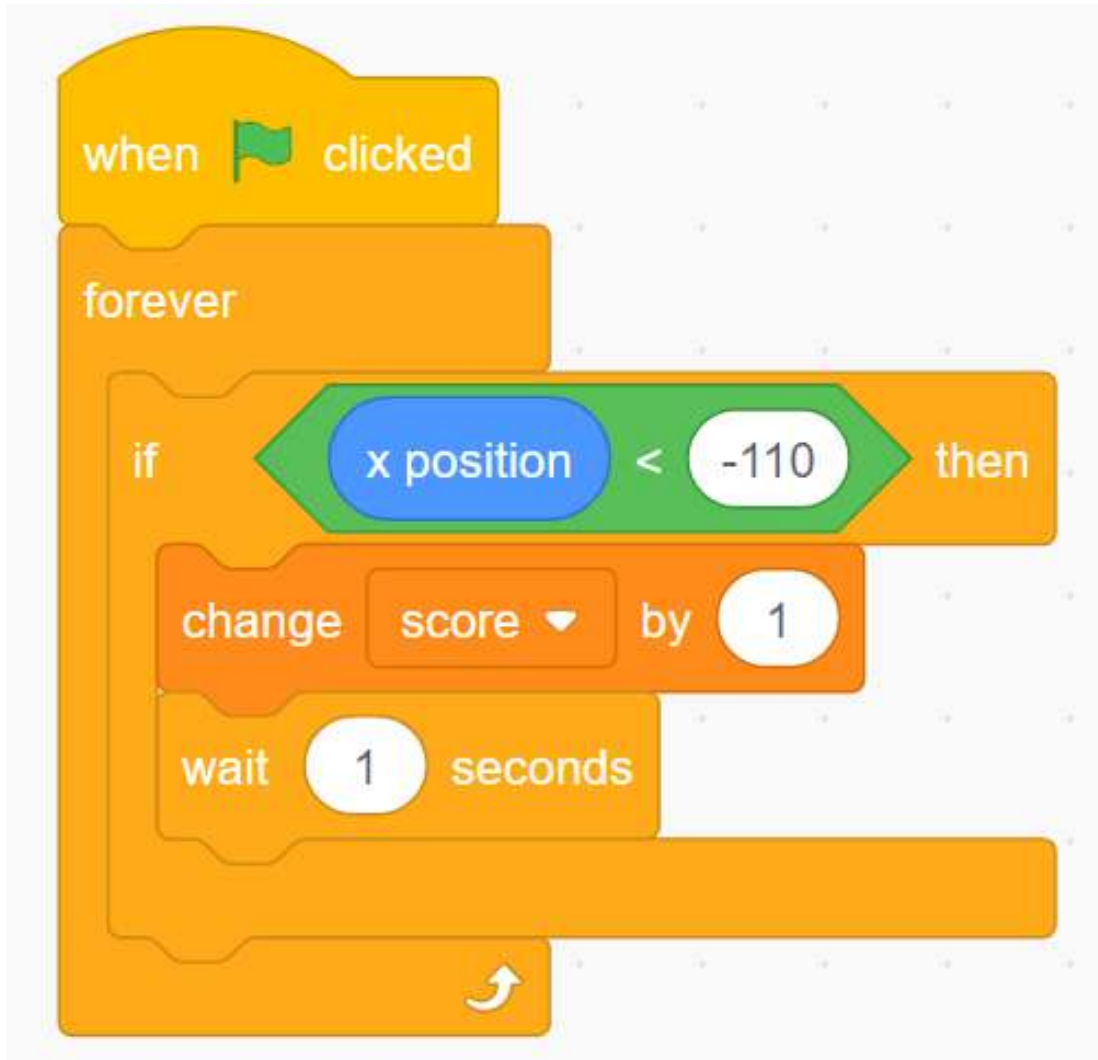

Game failure mechanism

When the Parrot sprite encounters a tree or falls to the ground during the flight, we judge the game is over, and then we stop all scripts.

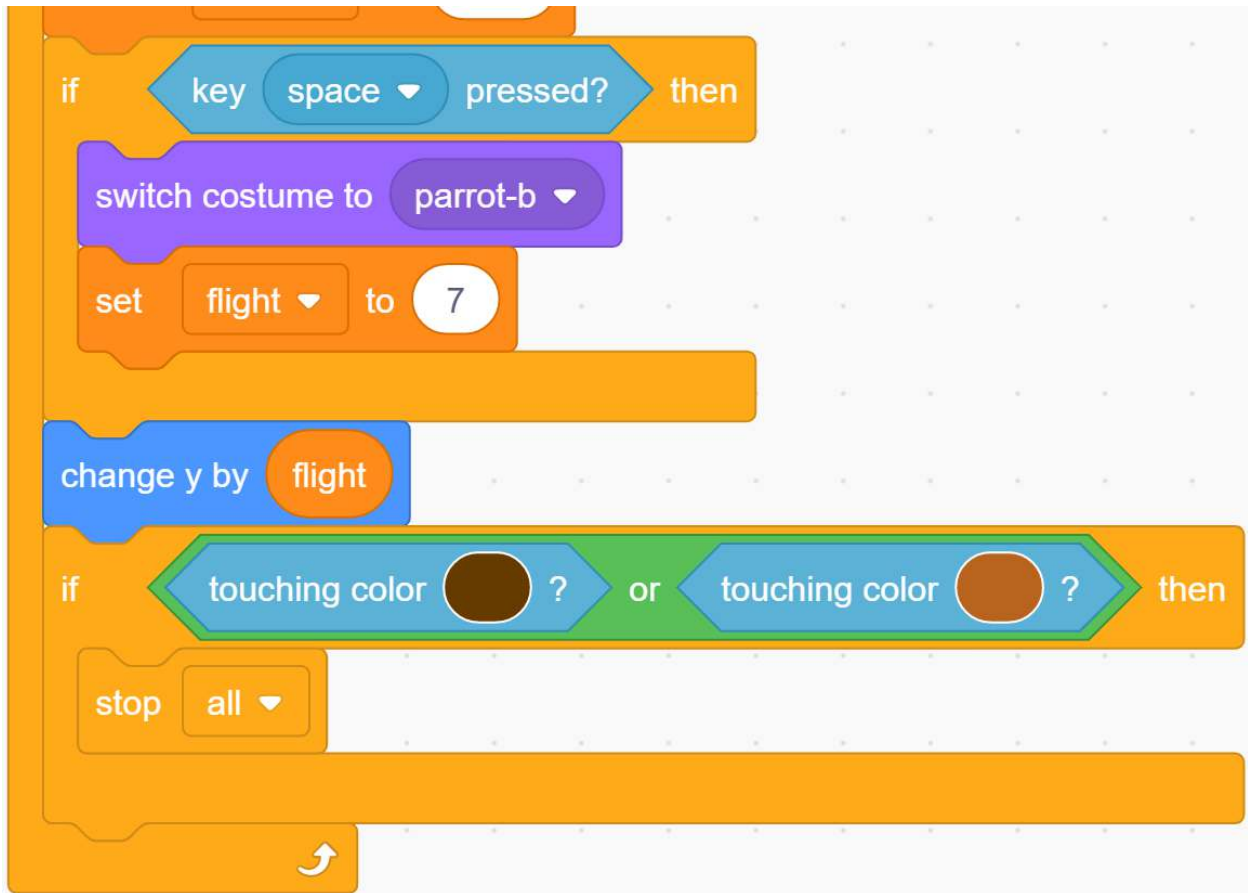

Challenge

I believe that you will be smart enough to program and implement this game soon. Next, we will add some challenges to enrich our game content.

- When the game fails, it switches to a cursing background screen.
- Add a countdown screen to the game start screen, let us prepare for the game.

5.7.9 Paint Box

Description

Have you ever had a Paint Box? You can use the colorful brushes in the Paint Box to paint a colorful world. Today we are also making an exclusive Paint Box on scratch. Let's take action.

Click on the green flag to start.

Or click [Paint Box](#), and then learn online tutorial on the Scratch official website.

Required Components

First, you need to prepare the following components:

- A Screen

- Scratch 3 (either online or offline)

You Will Learn

- Use the Pen extension function to draw on scratch.
- Let the sprite move with the mouse.
- Modify the size of the costume and the location of the cursor.
- Use the slider to modify the value of the variable.

Lesson Guide

Lay out the drawing board, add Pen expansion function

First, we delete the previous sprite, and then add the Pencil sprite and Block-X sprite to Scratch.

Upload **Eraser.svg**, **Red.png**, **Blue.png**, **Green.png**, **Yellow.png** and other files in the Sprite list (You have downloaded from [github - 7-diy-touch-screen](#) before.), and finally set the size of the Pencil sprite and Block-X sprite Change to 50.

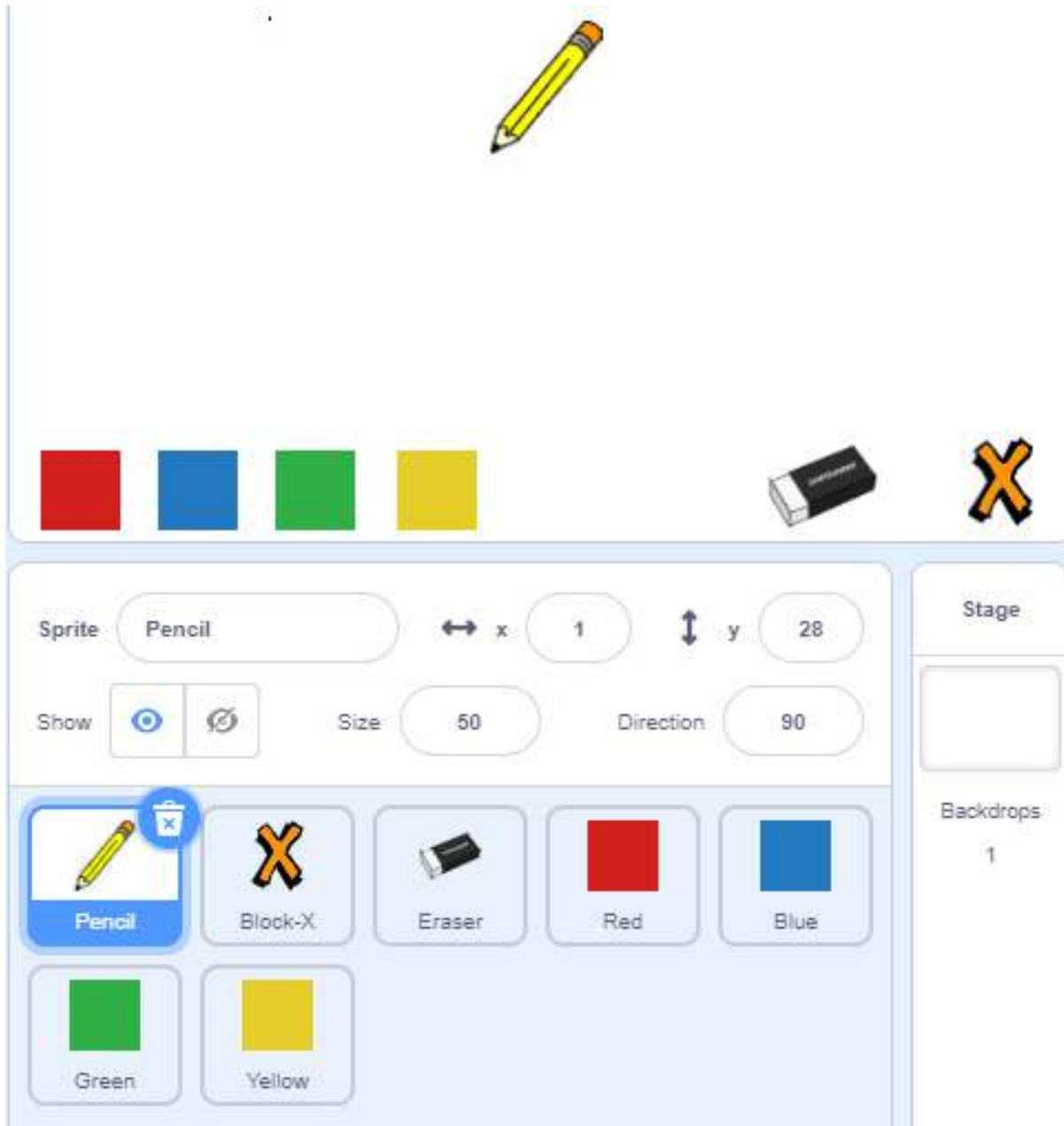

Then, we add the **Pen** extension function.

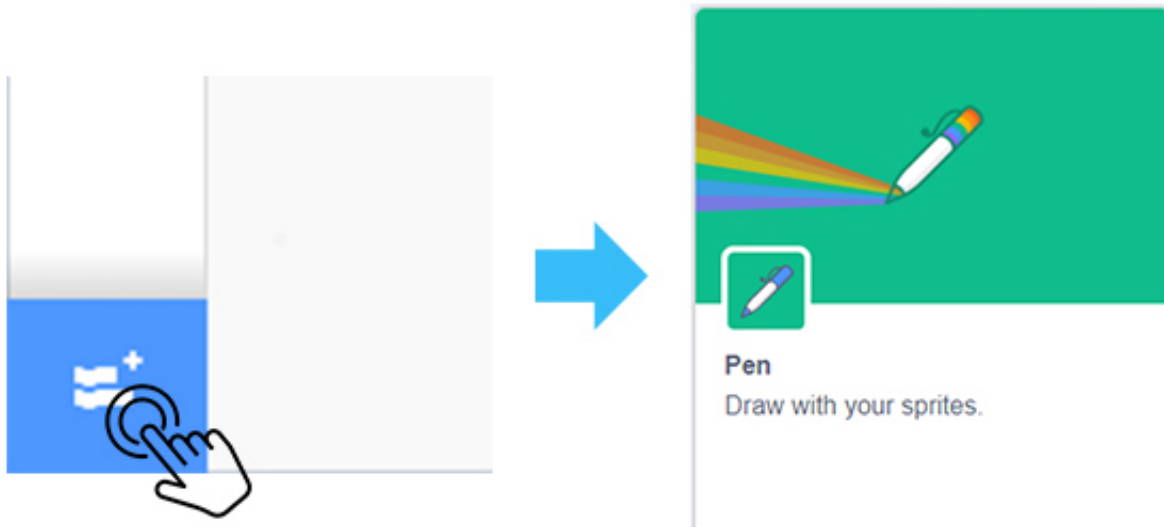

Add drawing function to Pencil sprite

Click on the Pencil sprite. First, we need to make the Pencil sprite move with the mouse. If the mouse button is pressed, we call the **pen down** block in the Pen extension function, which can draw along the track of the cursor. Otherwise, call the **pen up** block to stop drawing.

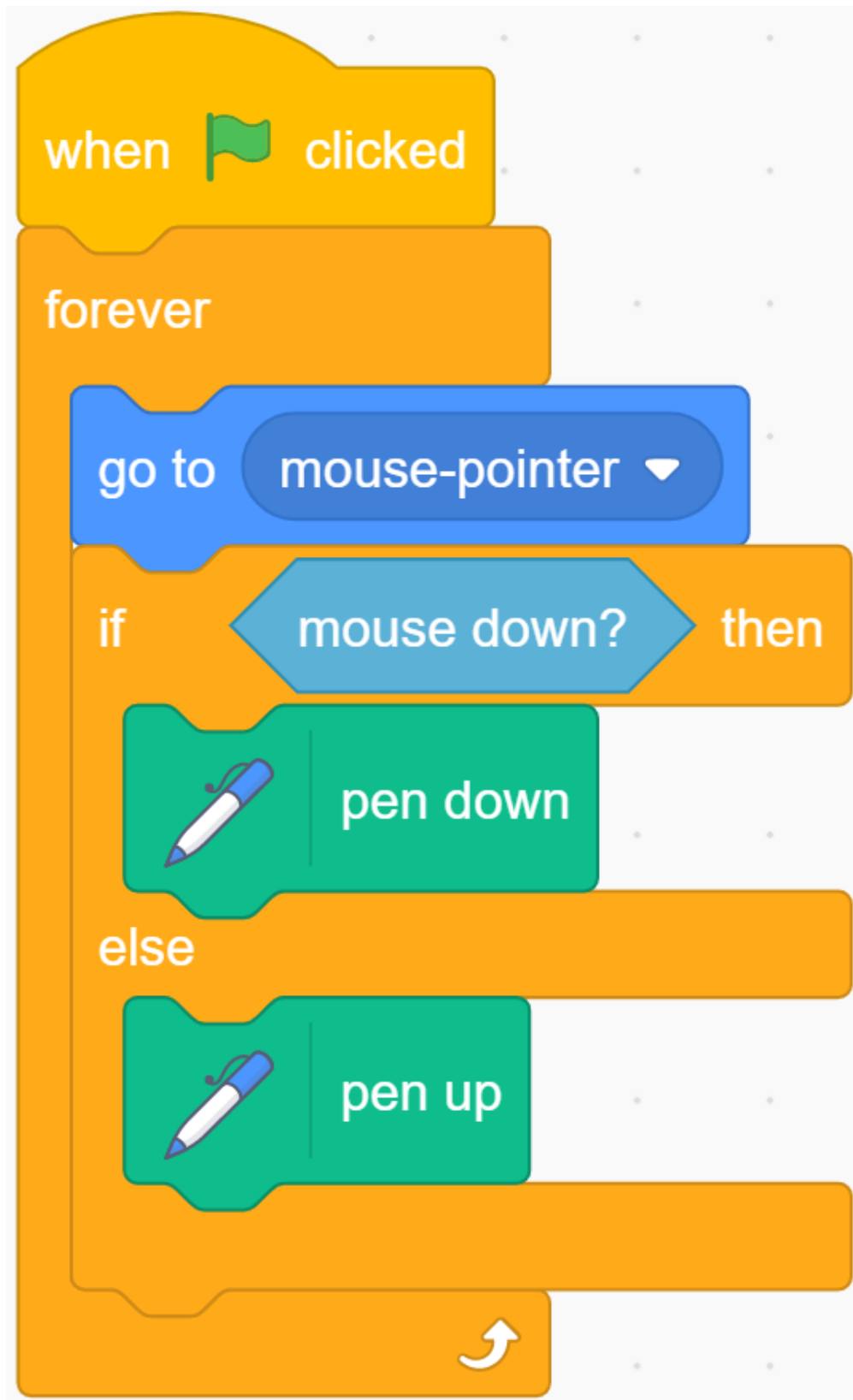

Click on the green flag and try to control the Pencil sprite with the mouse to draw a smiley face. You will find that the image is not drawn from the tip of the Pencil.

Note: Since the cursor is not on the Pencil tip, the line drawn is drawn from the middle of the Pencil sprite.

We click on the **Costumes**, select the entire Pencil sprite and move it until the Pencil tip is aligned with the cross cursor.

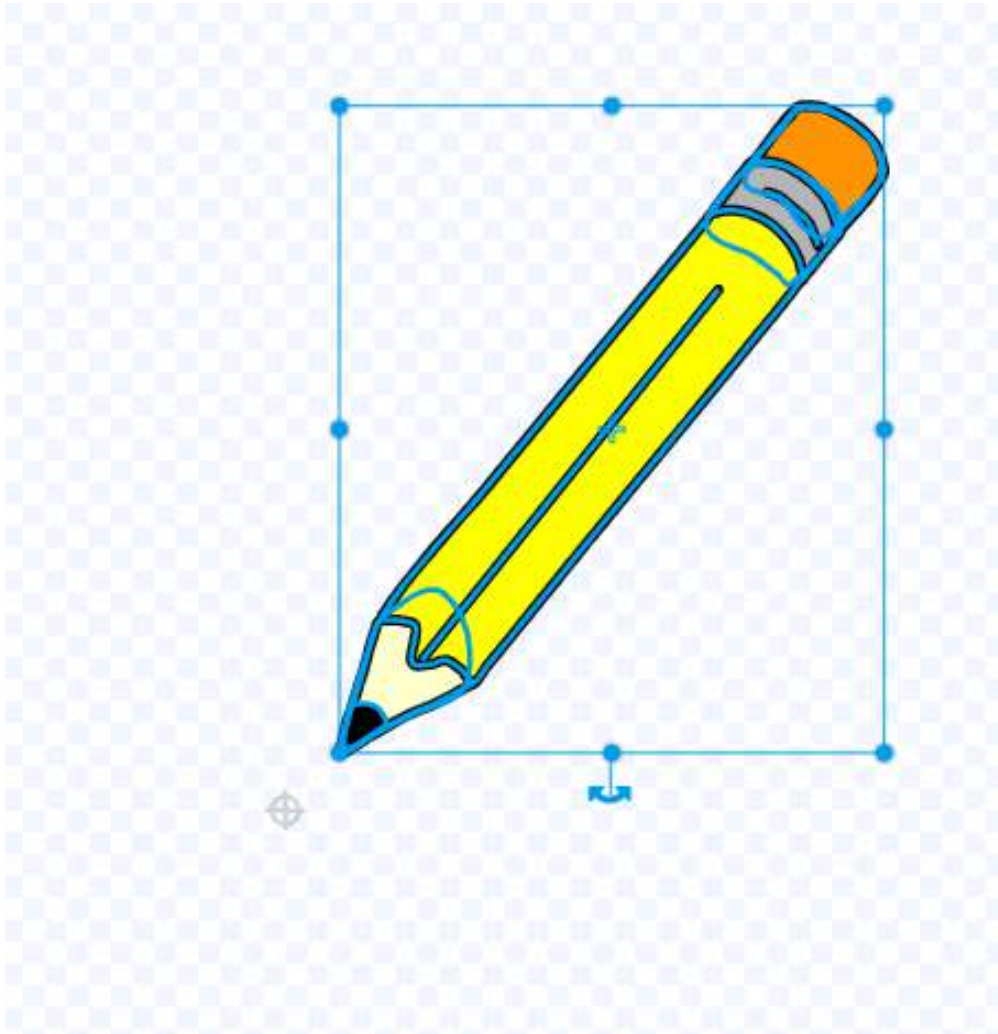

Let the Pencil sprite change the painting color.

How to achieve that when we click on the color option below the stage, the Pencil sprite will switch the corresponding color?

First we write code for the Red sprite, when it is clicked, we broadcast a new “red” message.

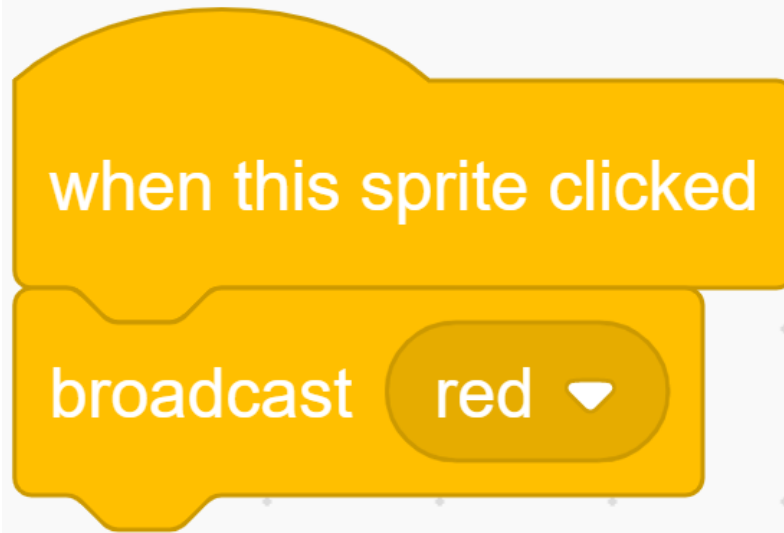

Then we return the code of the Pencil sprite, and when it receives the “red” message, we change the color of the Pencil to red.

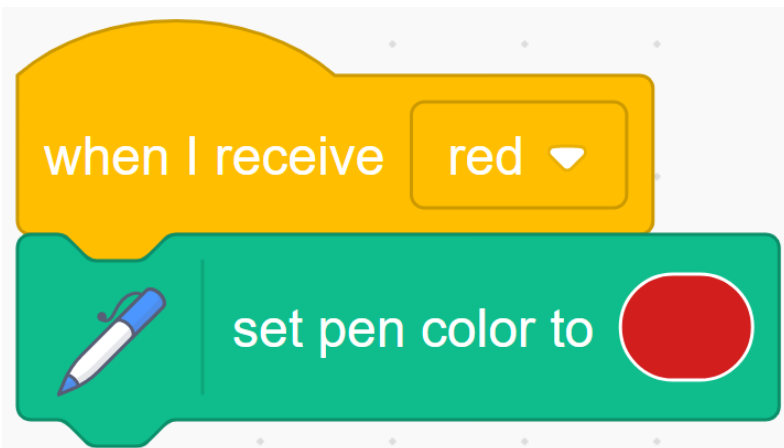

In the same way, we also write code for the Blue sprite, and when it is clicked, we broadcast a new “blue” message.

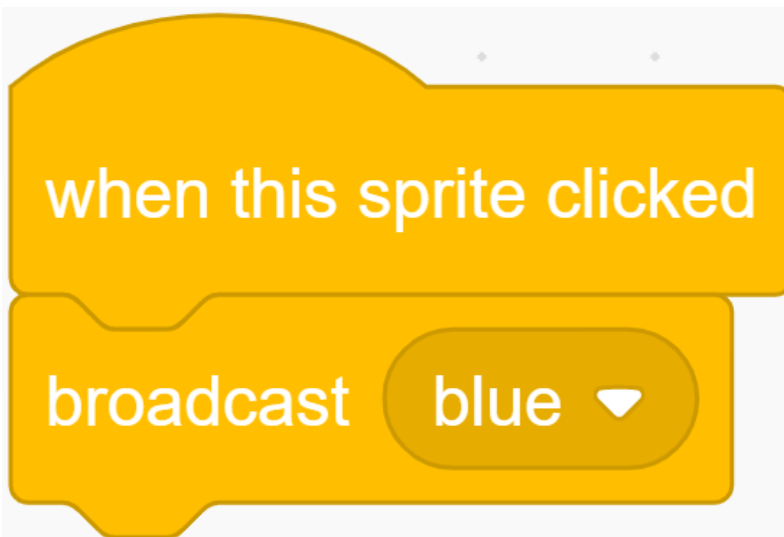

Return the code of the Pencil sprite. When it receives the “blue” message, we change the color of the Pencil to blue. Before painting, we clear the scene on the stage and set the Pencil color to red. Zoom in on the stage area and try your brush again.

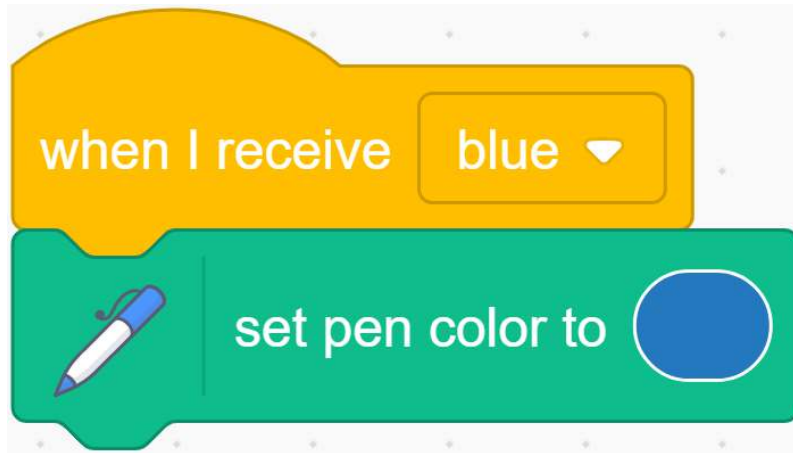

Add the function of clear drawing image.

Sometimes accidents happen when we draw, so we need to add a clear function. First select the Block-X sprite, when it is clicked, we clear all the screens.

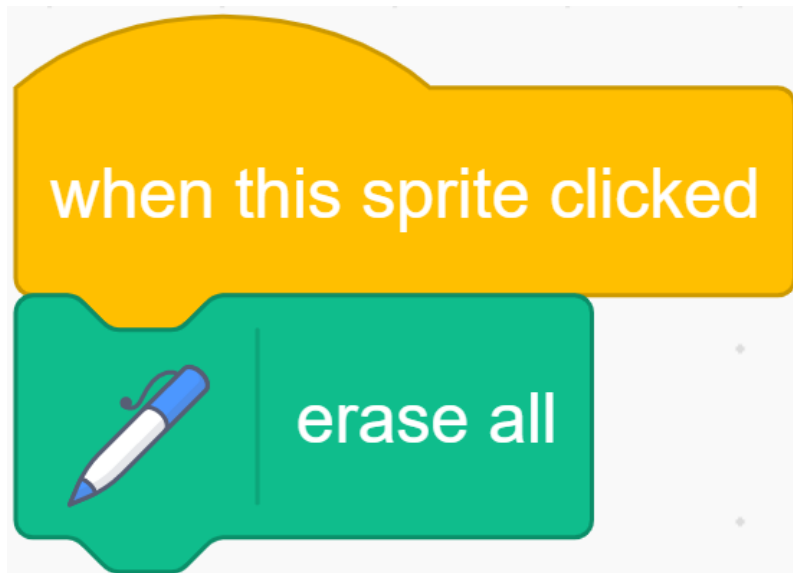

Next, we set a new costume for the Pencil sprite, click the “Costumes” tab, and then select the **Upload Costume** option from the icon on the bottom left to upload the **Eraser.svg** file.

Modify the size of the Eraser garment appropriately, and then place it on the upper right of the cursor.

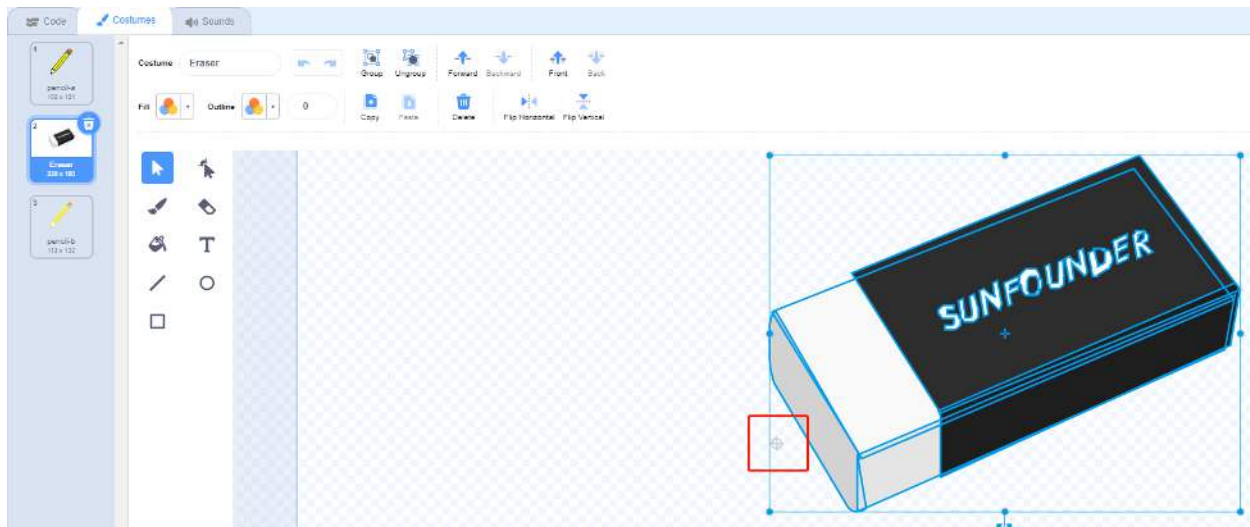

We started programming the Eraser sprite, and when it was clicked, we broadcast a new “eraser” message.

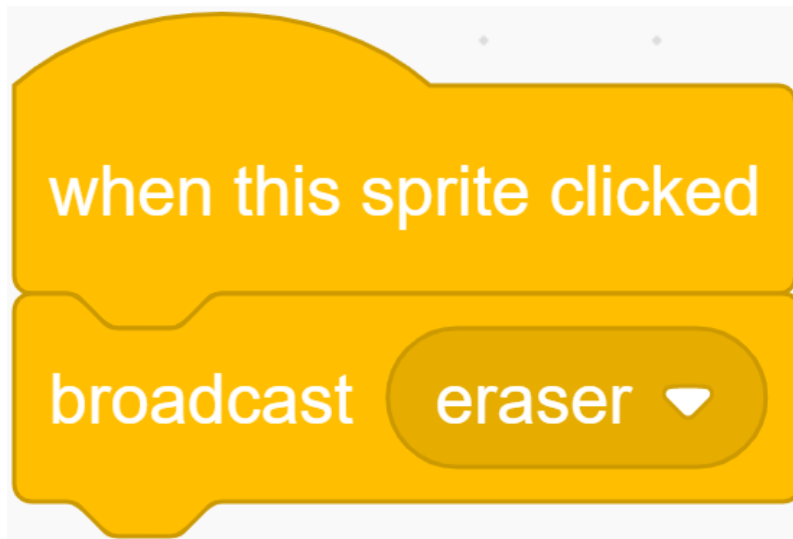

Then continue to add code for the Pencil sprite. When it receives the “eraser” message, it will change to the Eraser costume,

so that when we click on the Eraser sprite, we can change the Pencil sprite’s costume to look like an Eraser sprite.

Then change the color to white that is consistent with the background color of the stage, so as to achieve the function of partial removal.

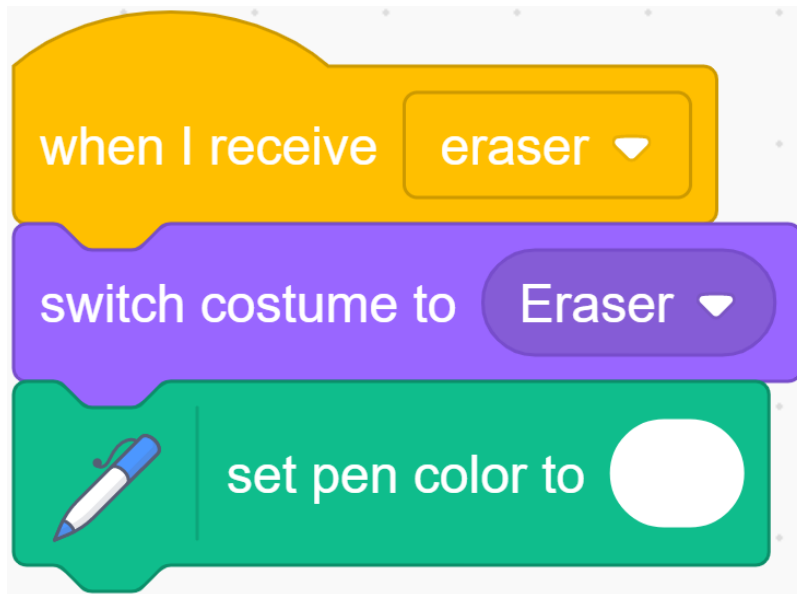

Toggle clothing and brush width tools.

When the costume of the Pencil sprite is switched to Eraser, we need to switch the costume of the Pencil sprite to the Pencil-a costume by clicking the red and blue on the drawing board, so when we receive the “red” message and the “blue” message, We want to switch back to the original Pencil-a costume.

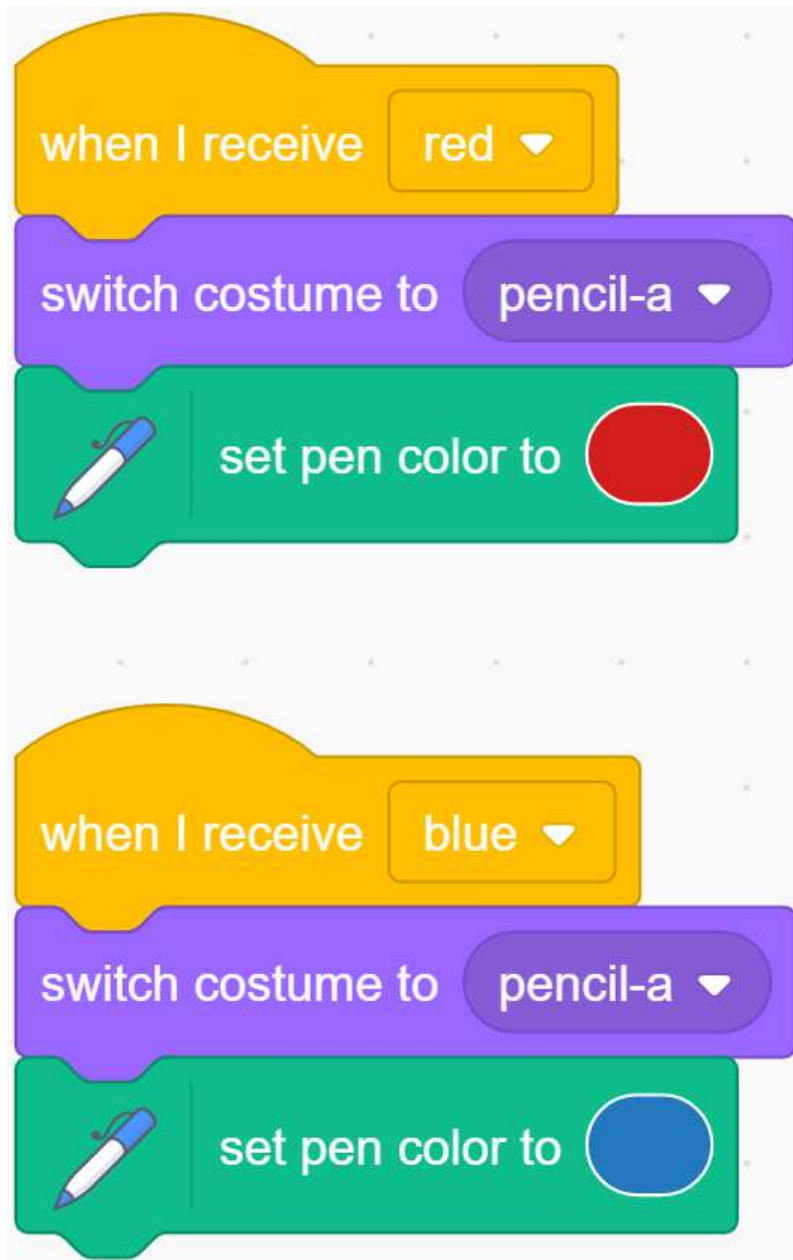

In order to make our painting function more fun, we need to be able to change the width of the Pencil at any time.

Create a new variable named “width”, then right-click the “width” variable on the stage, select slider, and then you will see a slider on the stage that can change the value of the “width” variable.

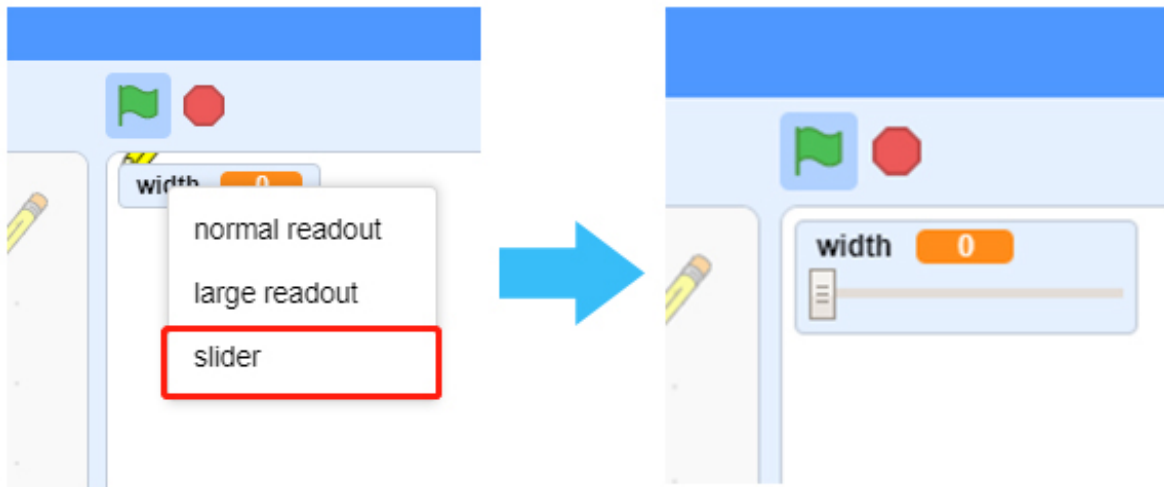

Use the value of the variable “width” as the size of the Pencil.

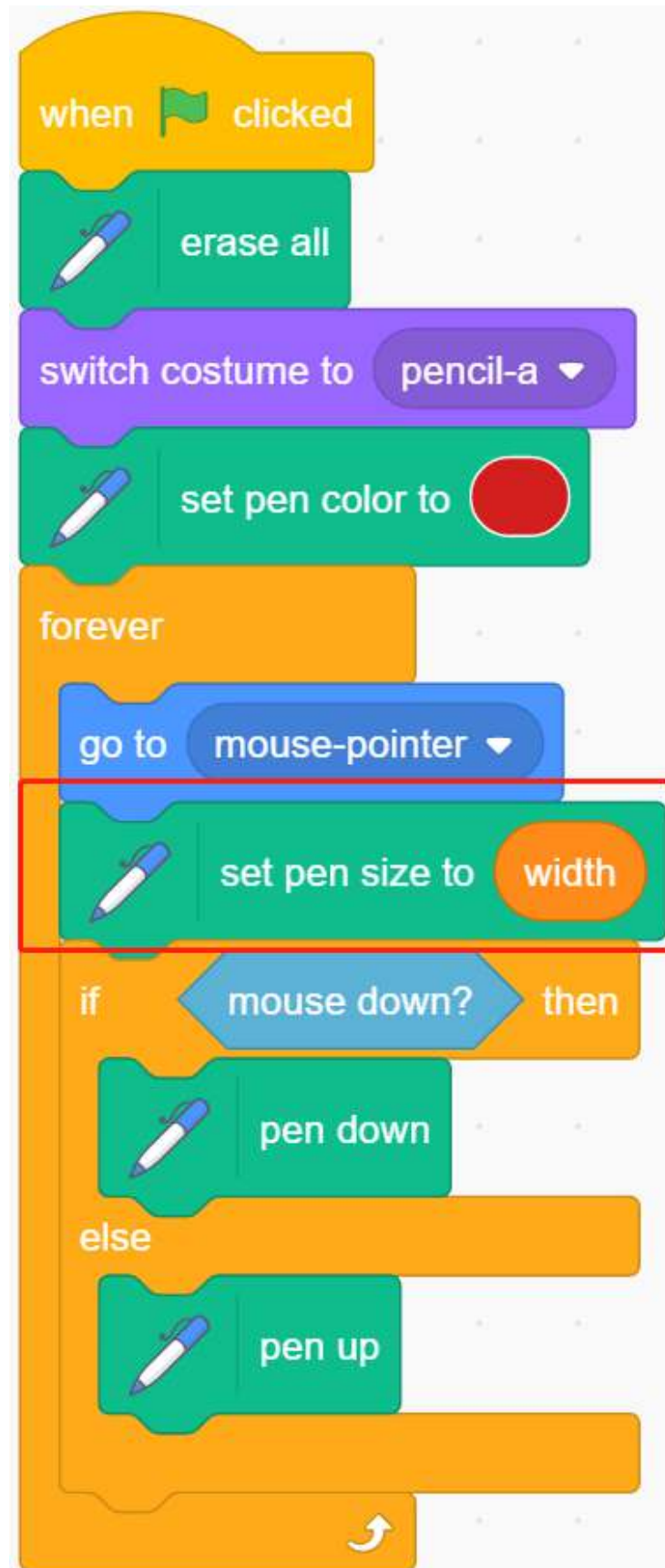

Limit the painting range of the Pencil.

Only when the Pencil enters the drawing area, can painting be allowed.

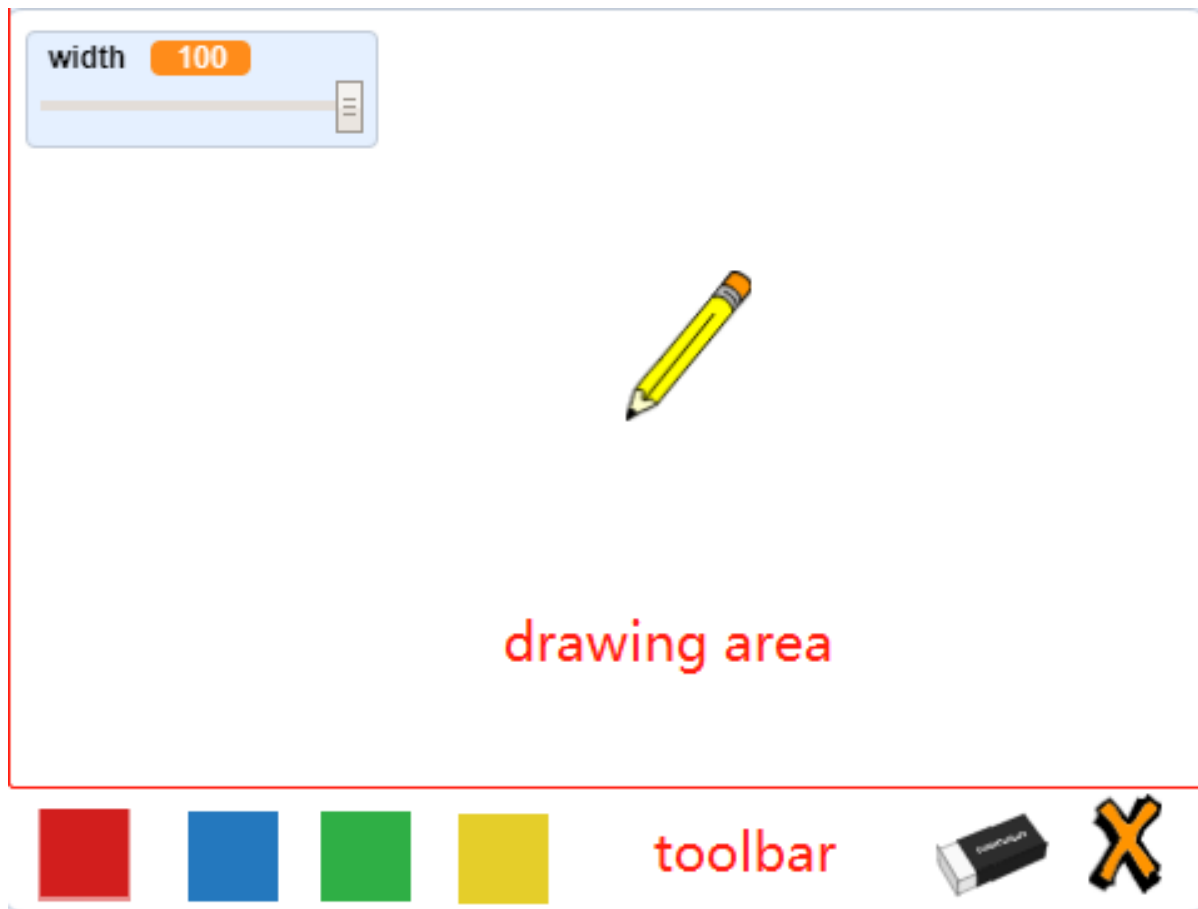

When the pen enters the toolbar, that is, when the y coordinate is less than or equal to -120, we need to call the **pen up** function to stop painting.

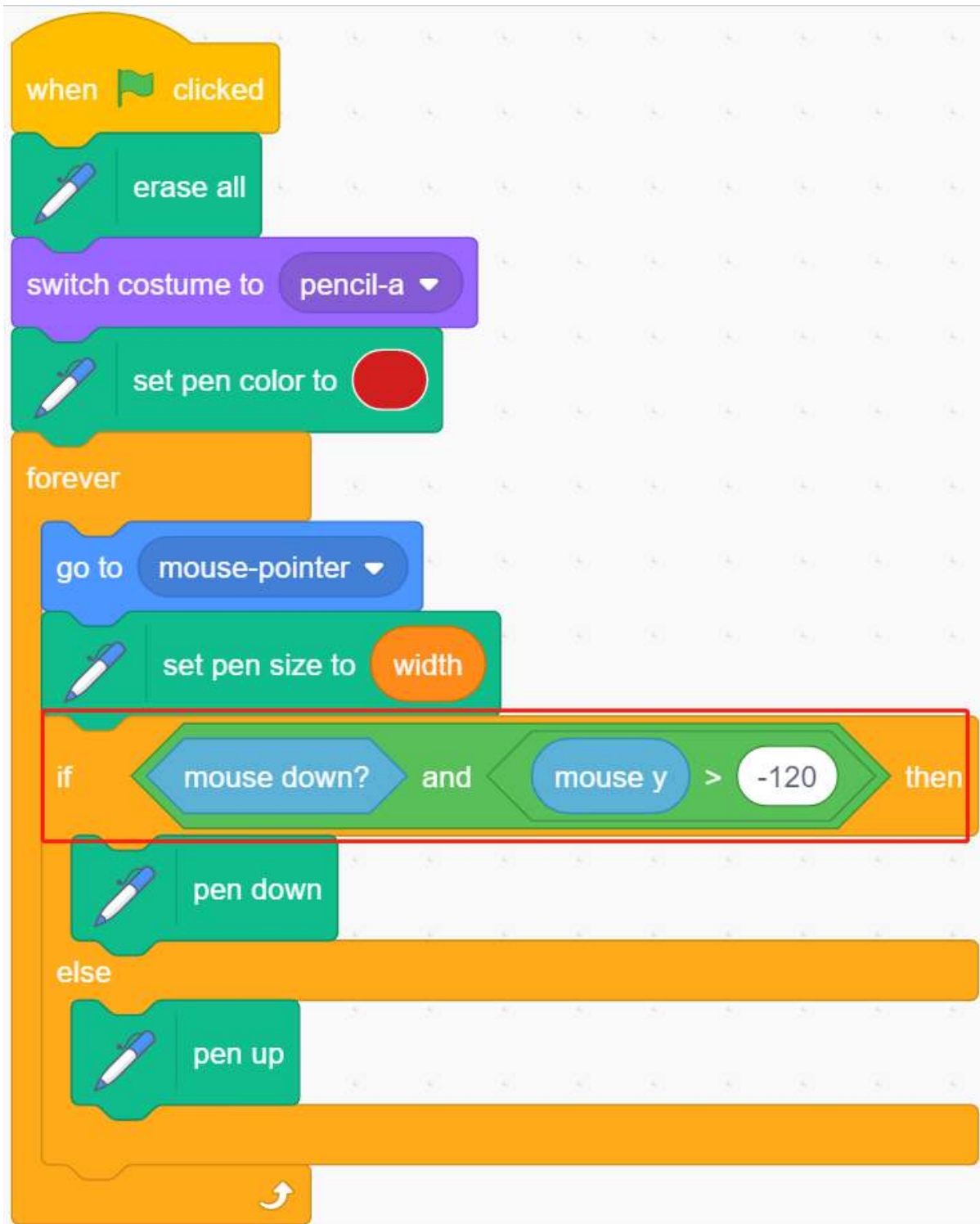

Challenge

I believe that you will be smart enough to program and implement this game soon. Next, we will add some challenges to enrich our game content.

- Add more color brushes to make a Paint Box that belongs to you.

5.7.10 Eating Banana Game

Description

Scratch has a Video Sensing expansion module, which can turn on the camera in Scratch and detect the movement of objects on the camera screen.

Today, we will use the camera to make a eating banana game. In the stipulated time, help the Monkey eat more bananas.

To play the game against a white background, click on the green flag to start. Move colored objects in front of the camera to control the Monkey sprite.

Or click [Eating Banana Game](#), and then learn online tutorial on the Scratch official website.

Required Components

- A Screen
- Scratch 3 (either online or offline)

You Will Learn

- Install camera on this screen.
- Add Video Sensing expansion module and use camera function
- Let the camera detect our movements

Lesson Guide

Install and use the camera.

For the camera installation tutorial, please refer to *Assemble the Camera Module*.

Click the “Add Extension” icon at the bottom left of scratch and select the **Video Sensing** extension.

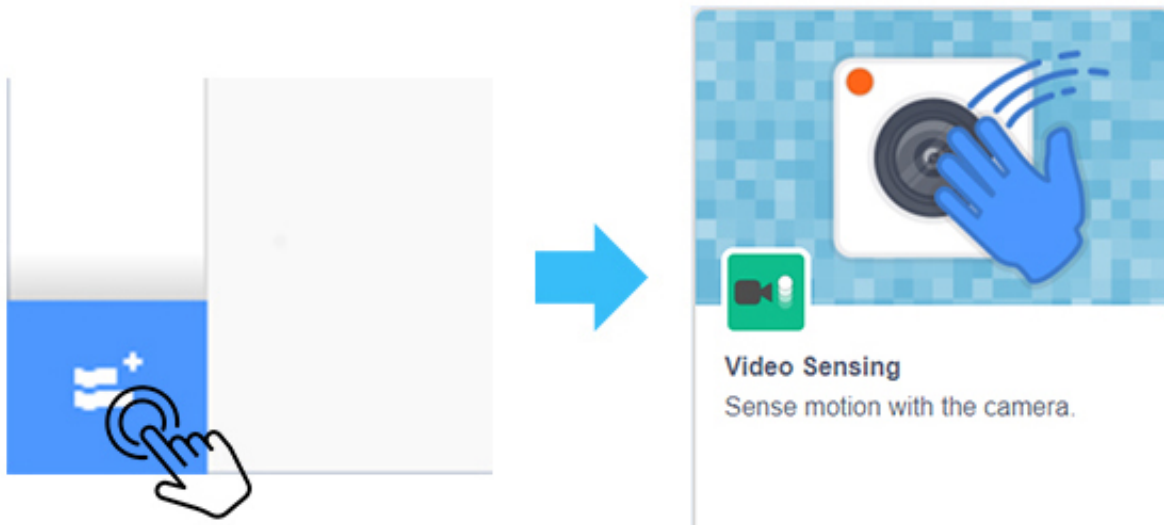

At this point, you can see the camera shot on the Scratch stage.

Arrange monkeys and bananas

First, we delete the original sprite, then add Monkey sprite and Bananas sprite, and change their sizes to 50.

Let Bananas appear randomly.



Bananas disappears after encountering the Monkey, which means it was eaten by the Monkey and reappears randomly.

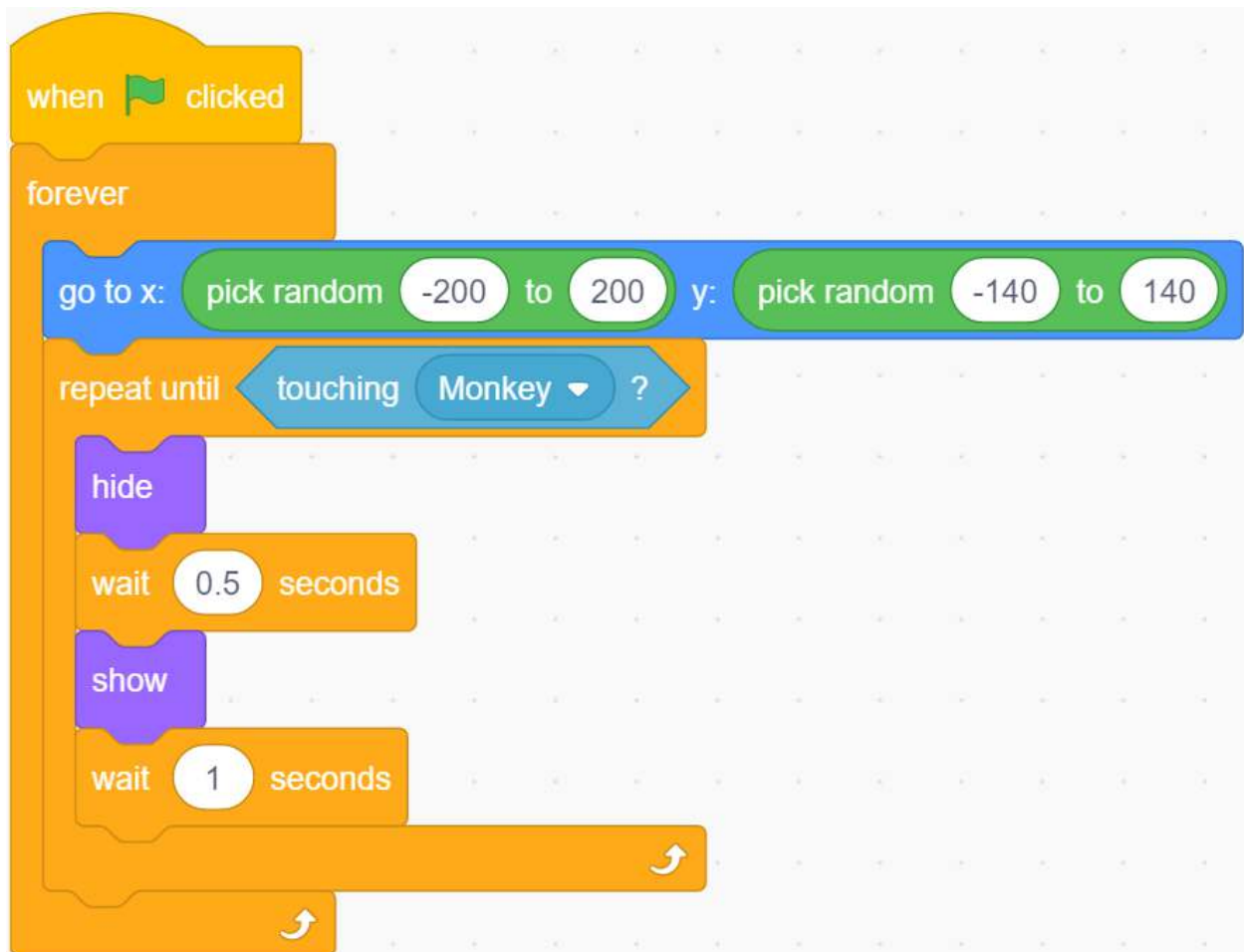

Let the Monkey appear in the center of the stage and initialize the camera data (transparency is set to 20).

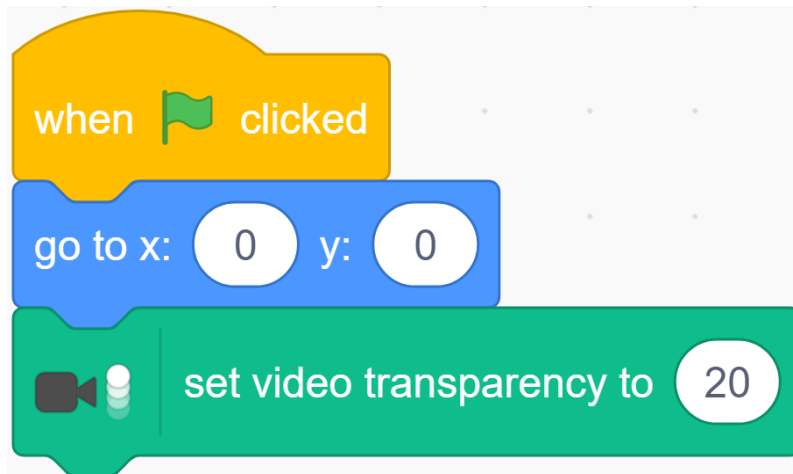

If the camera detects an object moving, let the Monkey move towards the object.

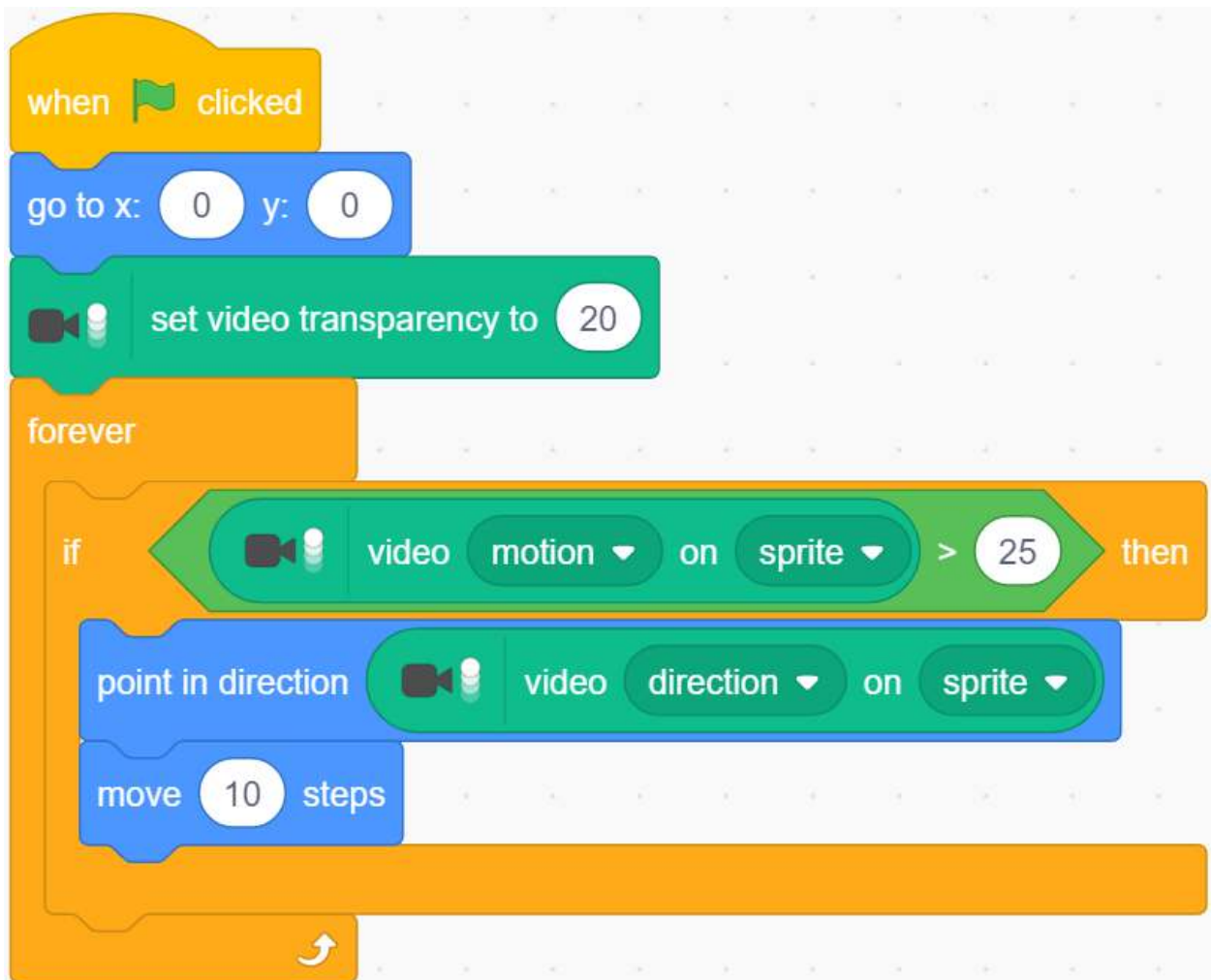

Now, click on the green flag at the top of the stage area to start the game.

Let the Monkey eat bananas, it is very hungry! Try to play this game on a white background to prevent interference from other objects.

Challenge

I believe that you will be smart enough to program and implement this game soon. Next, we will add some challenges to enrich our game content.

- When Monkey eats banana, we add 1 to the score. Within 30s, see who has the highest score!
- When Monkey eats a banana, it emits a suitable sound effect.

5.7.11 Create Musical Instrument

Description

You can turn this screen into a game screen playing with your friends, a smart alarm showing the weather and time, a display monitoring your robot's action and many other things.

This article will show you how to DIY a Musical Instrument. Let's take a look!



Required Components

- A Screen
- 8G+ SD Card
- Scratch 3 (either online or offline)
- Micro SD Card Reader
- 40 Pin Ribbon Cable
- T-Type GPIO Extension Board
- Breadboard
- Button

- 10k Ohm Resistor
- Several Jumper Wires

You Will Learn

- Use note functions on Scratch.
- Input the button value from the GPIO pins.

Lesson Guide

Build the Circuit

First connect the GPIO Extension Board, please read *GPIO Extension Board* for specific steps.

Insert the T-type GPIO extension board into the breadboard and build the circuit as shown below.

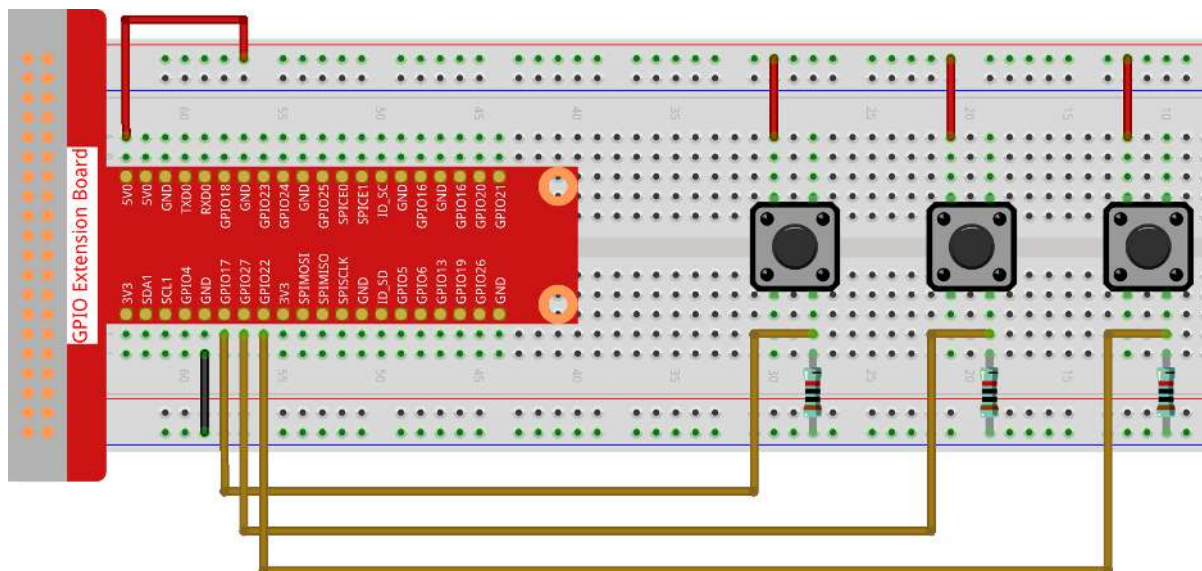

Programming with Scratch 3

On the left of Scratch 3 main page are some neatly arranged blocks with which you can drag to program. In this project, we need to add in other two functions: Music and Raspberry Pi GPIO. The Music function to play instruments and drums, and the Raspberry Pi GPIO function can be used to control the whole pins of Raspberry Pi.

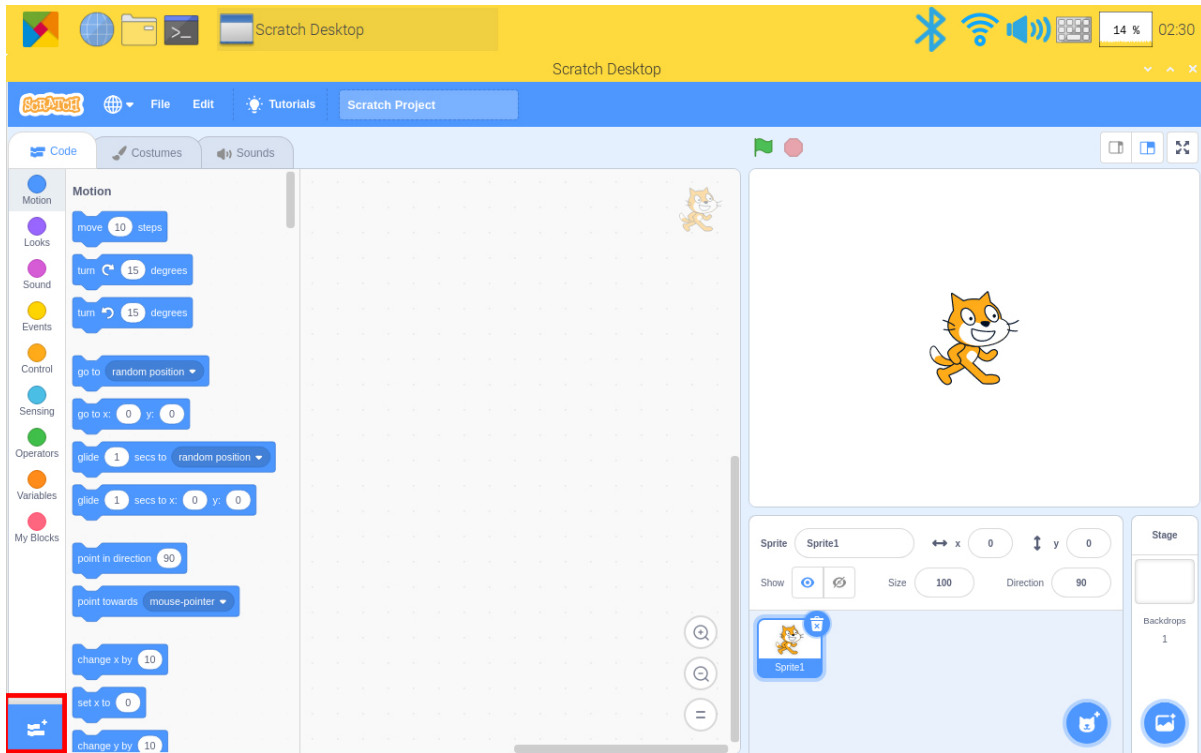

Tap Add icon at lower left corner and choose Music and Raspberry Pi GPIO to add two functions on the left of the main page of the Scratch 3.

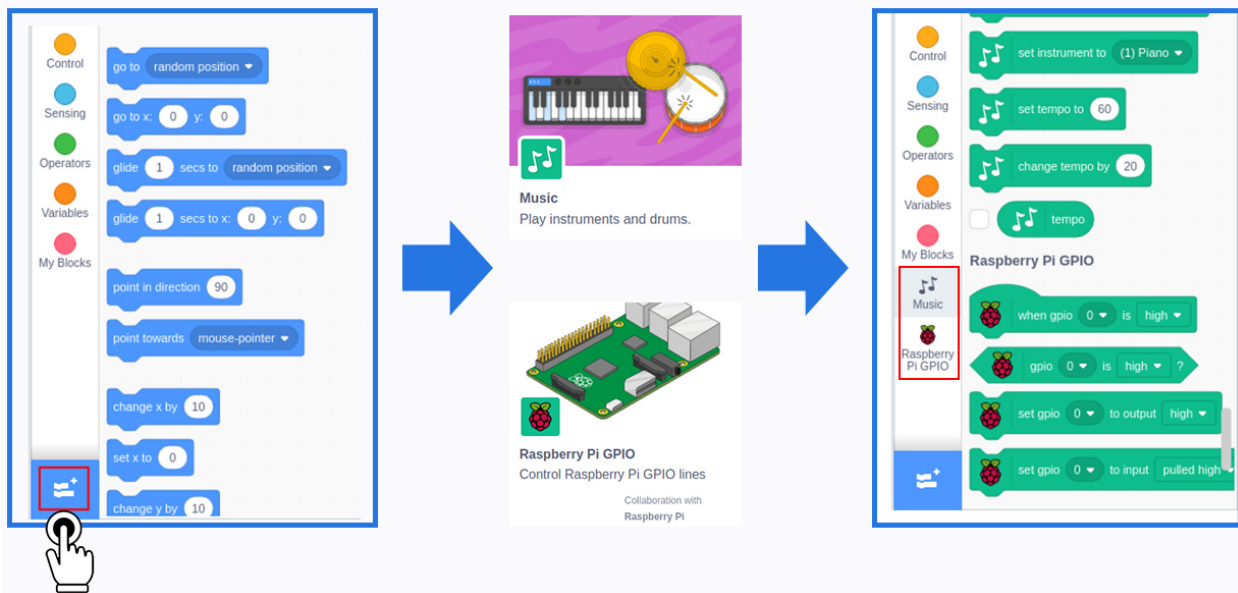

Finished the program.

The image shows the Scratch code editor interface. On the left is a sidebar with various block categories: Motion, Looks, Sound, Events, Control, Sensing, Operators, Variables, My Blocks, Music, and Raspberry Pi GPIO. The main workspace is divided into two sections: 'Music' and 'Raspberry Pi GPIO'. The 'Music' section contains several blocks: 'play drum (1) Snare Drum for 0.', 'rest for 0.25 beats', 'play note 60 for 0.25 beats', 'set instrument to (1) Piano', 'set tempo to 60', and 'change tempo by 20'. The 'Raspberry Pi GPIO' section contains two blocks: 'when gpio 0 is high' and 'gpio 0 is high ?'. A red rectangular box highlights a sequence of six blocks: 'when gpio 17 is high', 'play note 60 for 0.25 beats', 'when gpio 27 is high', 'play note 62 for 0.25 beats', 'when gpio 22 is high', and 'play note 64 for 0.25 beats'.

Press these three buttons on the breadboard and there emits the tones “Do, Re, Mi”.

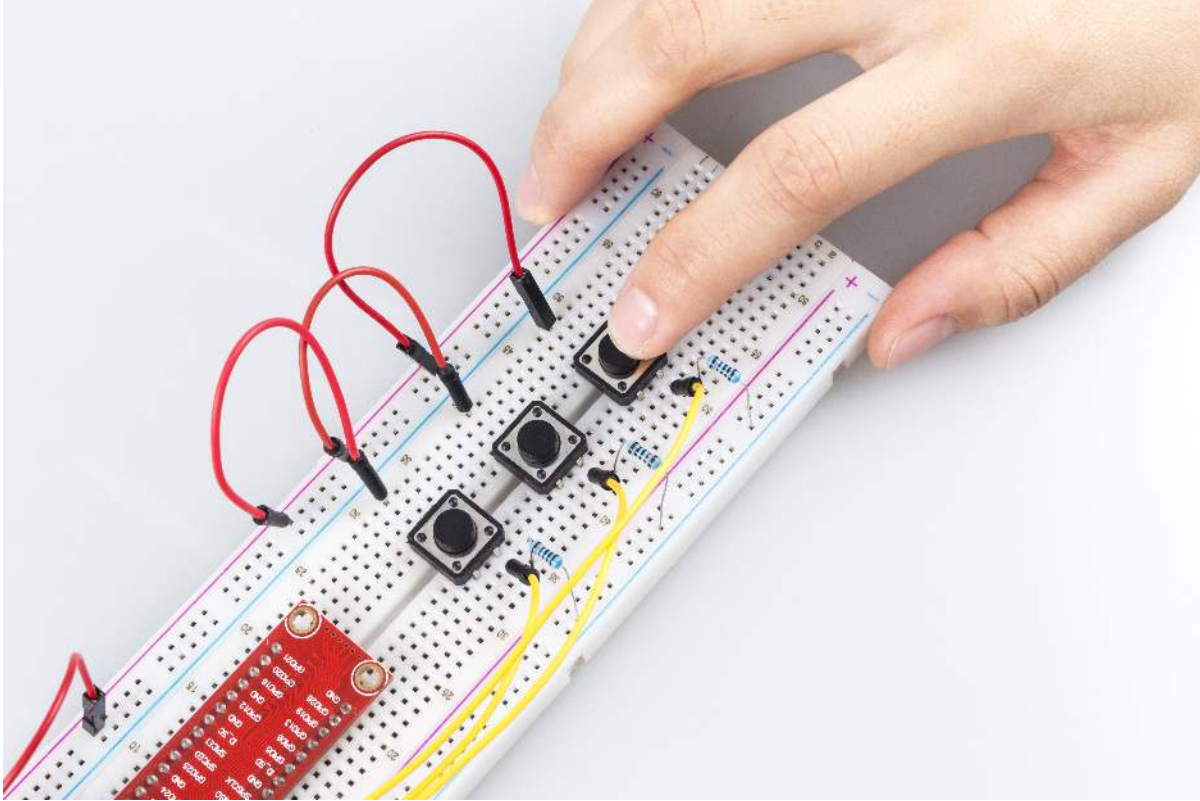

5.7.12 DIY Monitor Device

Description

You can turn this screen into a game screen playing with your friends, a smart alarm showing the weather and time, a display monitoring your robot's action and many other things.

This article will show you how to DIY a Monitor Device. Let's take a look!

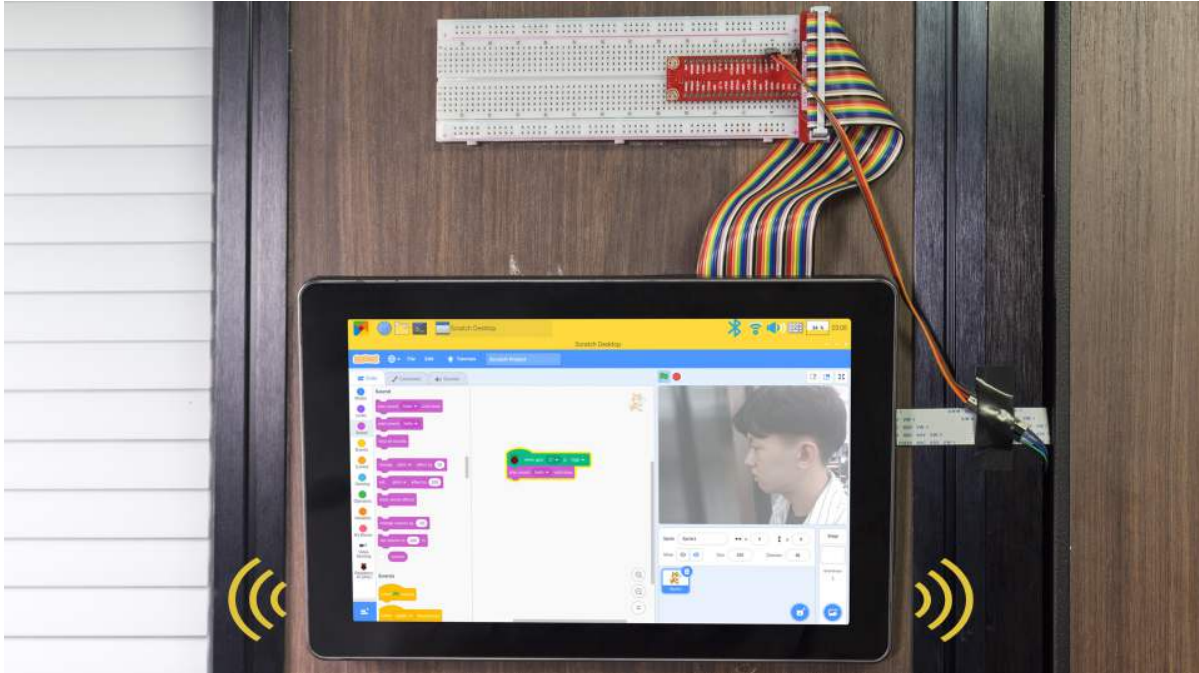

Required Components

- A Screen
- 8G+ SD Card
- Scratch 3 (either online or offline)
- Micro SD Card Reader
- 40P Ribbon Cable
- T-Type GPIO Extension Board
- Breadboard
- PIR Module
- Camera Module
- FFC Cable
- Jump Wire F/M

You Will Learn

- Use Raspberry Pi extensions on Scratch.
- Use audio functions on Scratch.
- Use PIR module.

Lesson Guide

Build the Circuit

First connect the GPIO Extension Board, please read *GPIO Extension Board* for specific steps.

Plug the T-type GPIO extension board into the breadboard and build the circuit.

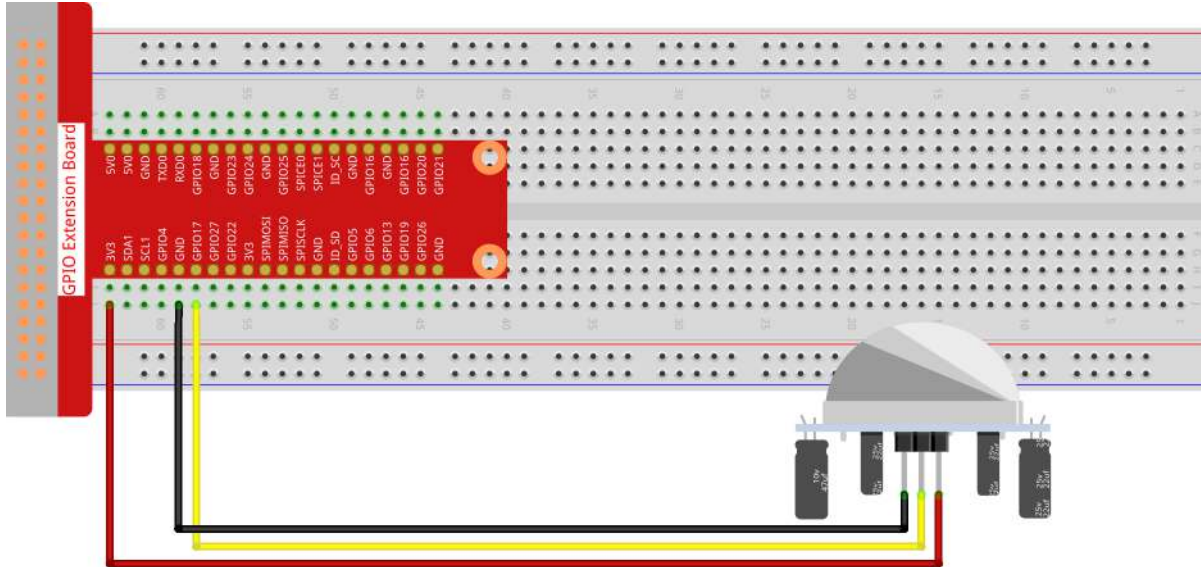

For the camera installation tutorial, please refer to *Assemble the Camera Module*.

Programming with Scratch 3

In this step you will learn how to upload the prepared music to the Scratch. Tap the “Sounds” option on the left upper corner then tap the “speaker” icon and choose “Upload Sound” icon to upload the prepared music file - hello, finally tap “Open” to confirm.

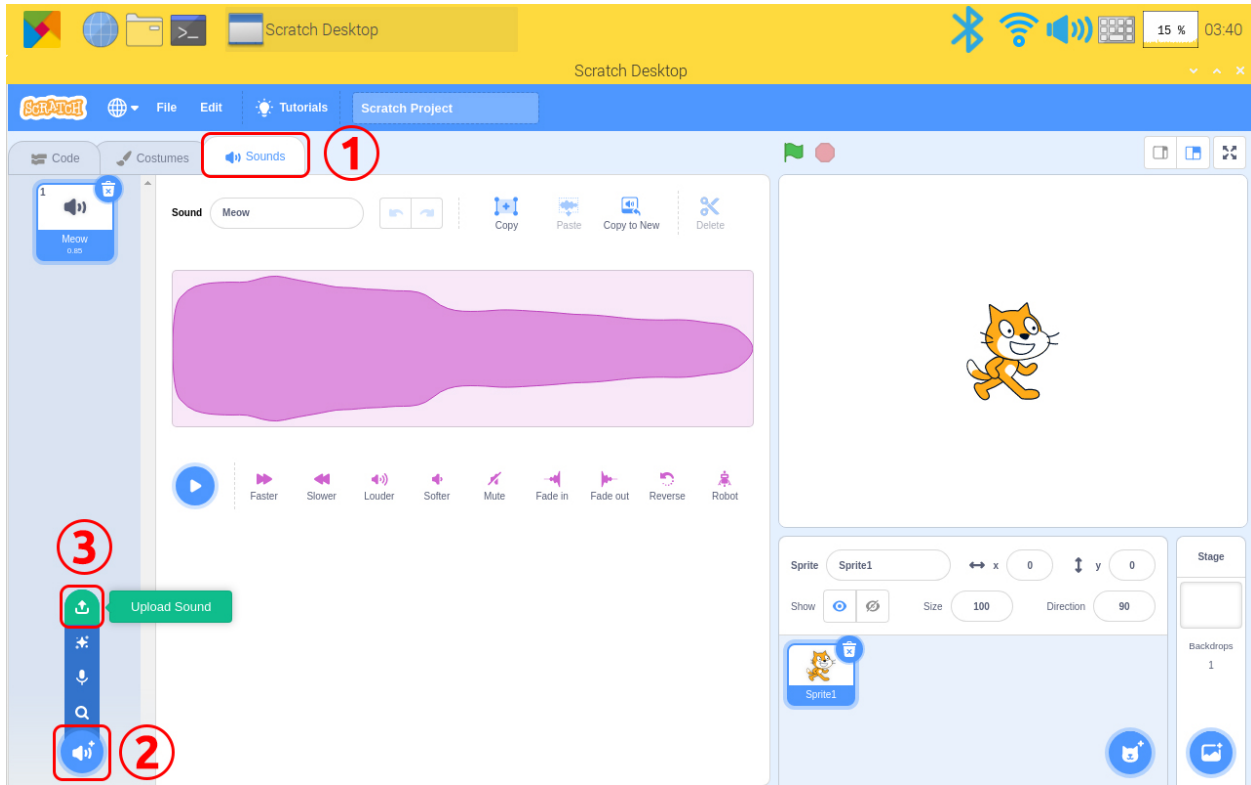

Tap Add icon at lower left corner and choose “Video Sensing” and “Raspberry Pi GPIO” to add two functions.

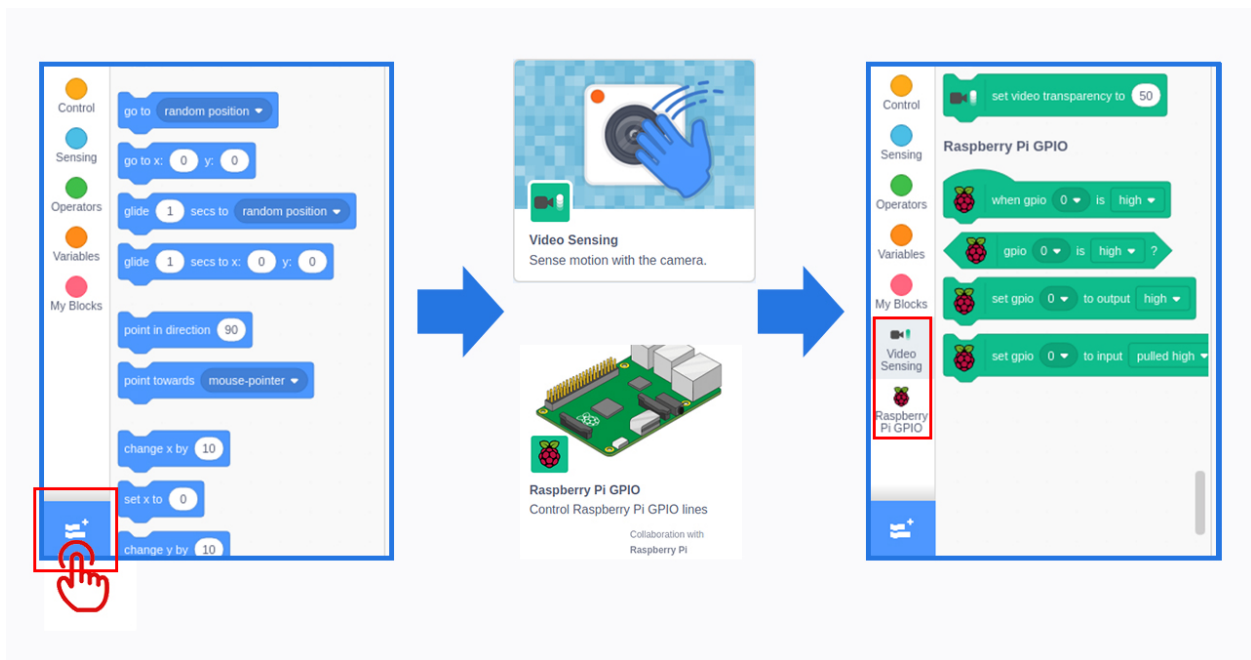

Back to the main page, drag a “when gpio 0 is high” from Raspberry Pi GPIO function and a “play sound (hello) until done” to the coding area.



Stick the pir module and camera to the wall outside the door, and stick the screen to the wall inside the door or anywhere. When the door is opened, you will hear music and then see who is there.

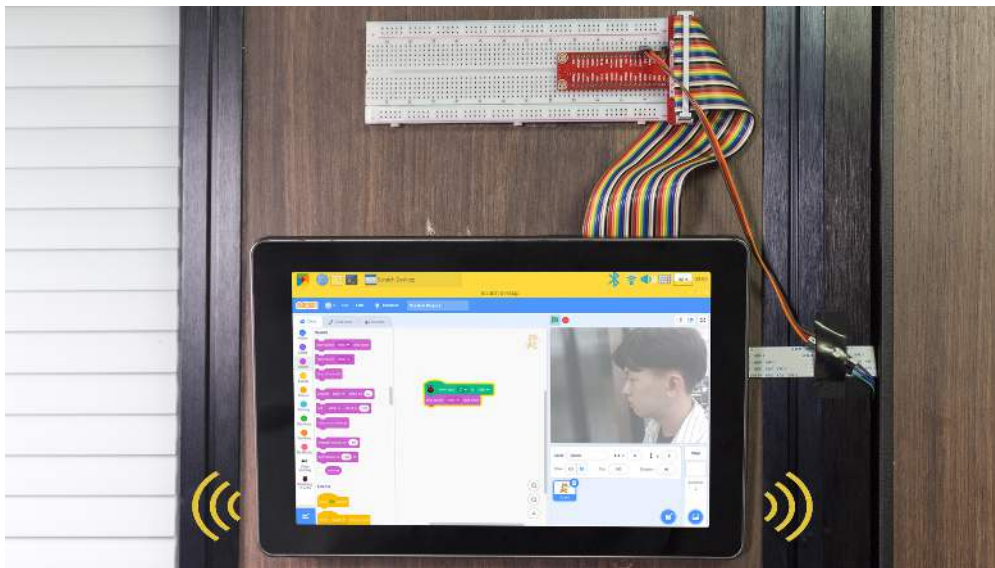

5.8 Install Other Systems on Raspberry Pi

In addition to the **Raspberry Pi OS**, and RetroPie Operating system that we used before, Raspberry Pi also supports other operating systems.

Here we only provide a link for learning reference. You can try it again according to the operation steps above the link.

Note: We have only tested Raspberry Pi OS, Ubuntu MATE , RetroPie on Raspberry Pi. If you have other systems installed, but some of them may have some bugs that make some of the functions unusable, we can only suggest you to consult the developer of that system.

23 Operating Systems That Run on Your Raspberry Pi.

CONNECT THE SCREEN TO THE PC

Connect the computer and the 7-inch touch screen via an HDMI cable and the USB cable. Now you can use the screen as an extension one for your computer.



APPENDIX

For new Raspberry Pi users, the following sections are essential operations that will need to be used for doing certain projects. Please read these sections carefully.

7.1 Assemble the Camera Module

On the camera module or Raspberry Pi, you will find a flat plastic connector. Carefully pull out the black fixing switch until the fixing switch is partially pulled out. Insert the FFC cable into the plastic connector in the direction shown and push the fixing switch back into place.

If the FFC wire is installed correctly, it will be straight and will not pull out when you gently pull on it. If not, reinstall it again.

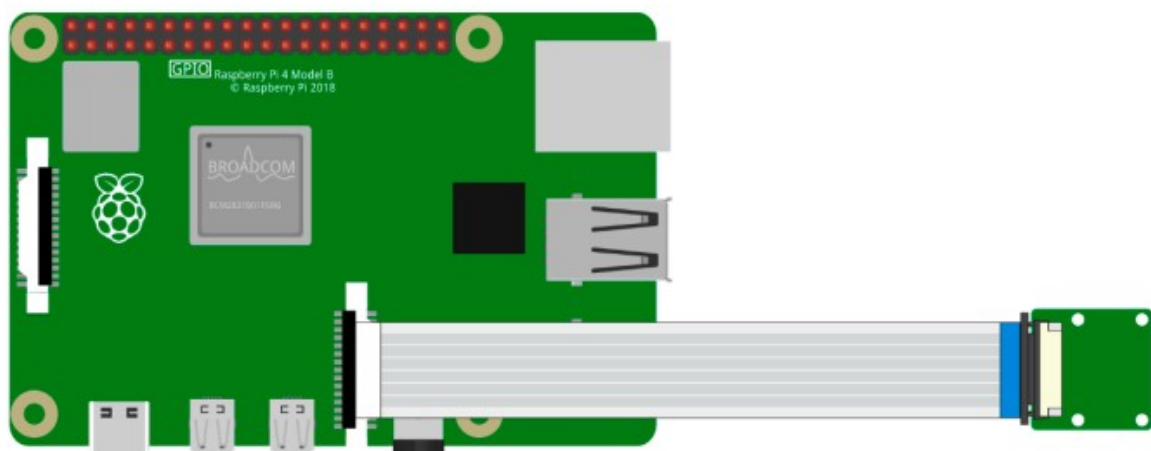
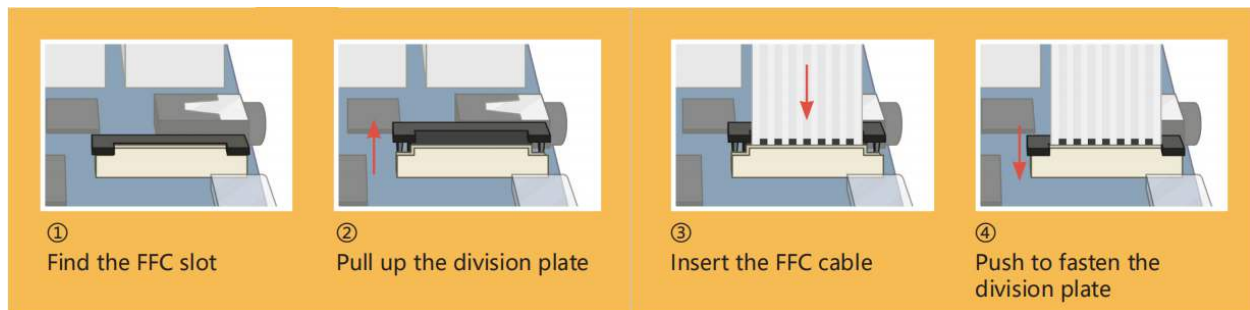

Warning: Do not install the camera with the power on, it may damage your camera.

Open **Raspberry Pi Configuration**.

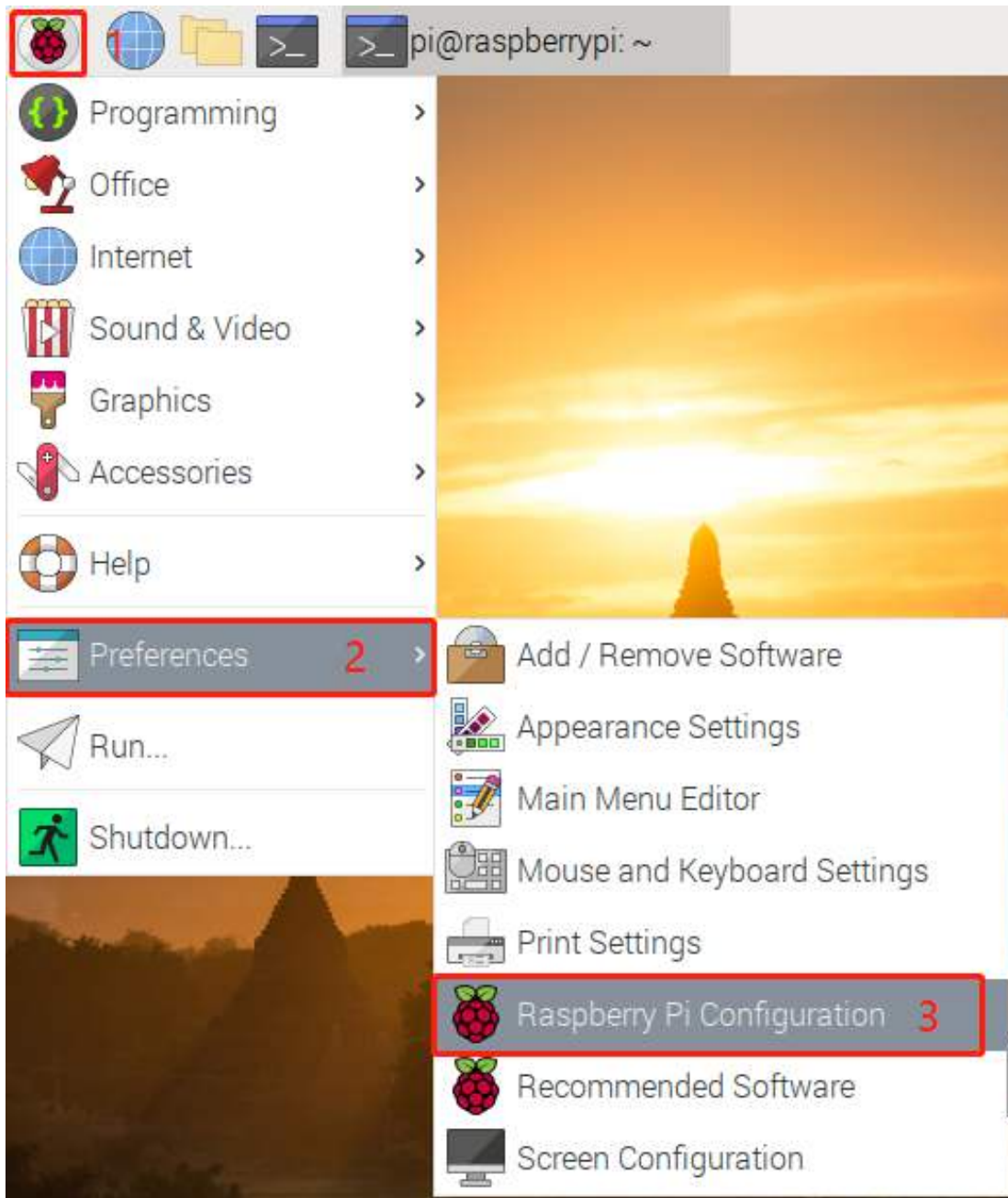

In the **Interfaces** option, **Enable** the Camera, and then click **OK**.

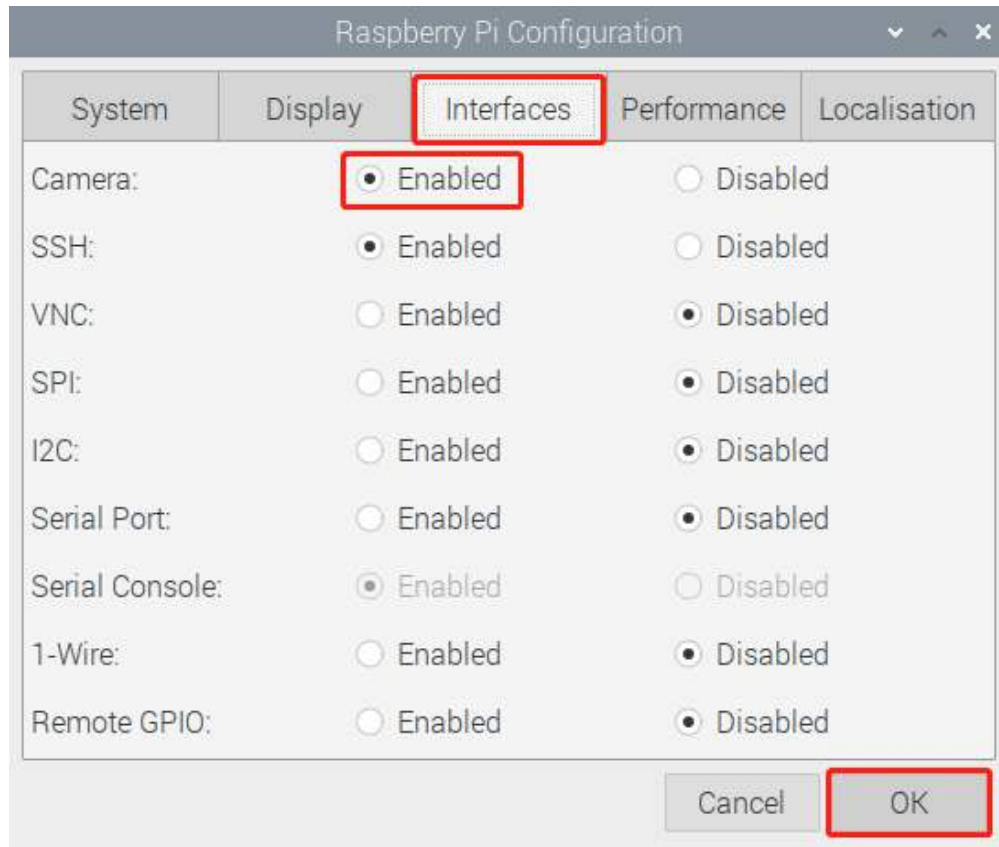

In the pop-up prompt box, choose to restart now.

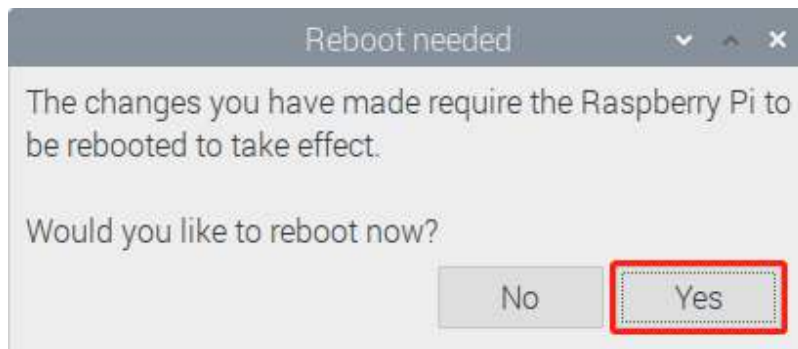

After the restart is complete, use the following command line to check whether the camera is available.

If the camera screen appears it means that the camera is installed successfully. Otherwise the FFC cable needs to be unplugged and plugged in again.

```
raspivid -o vid.h264
```

7.2 GPIO Extension Board

Before starting the project, you first need to know more about the pins of the Raspberry Pi, which is key to the build circuit.

7-inch DIY Touch Screen

The pins of Raspberry Pi have three ways to name them. They are wiringPi, BCM and Board. Among these naming conventions, the 40-pin GPIO Extension board uses the naming convention BCM.

The following table shows the naming convention for wiringPi, Board and the intrinsic Name of each pin on GPIO Extension board.

For example, for the GPIO17, the Board naming method of it is 11, the wiringPi naming method is 0, and the intrinsic naming method of it is GPIO0.

Name	WiringPi	Board	BCM	Board	WiringPi	Name
GPIO Extention Board						
3.3V	3V3	1	3V3	5.0V	2	5V
SDA	8	3	SDA	5.0V	4	5V
SCL	9	5	SCL	GND	6	0V
GPIO7	7	7	GPIO4	TXD	8	15
0V	GND	9	GND	RXD	10	16
GPIO0	0	11	GPIO17	GPIO18	12	1
GPIO2	2	13	GPIO27	GND	14	GND
GPIO3	3	15	GPIO22	GPIO23	16	4
3.3V	3.3V	17	3.3V	GPIO24	18	5
MOSI	12	19	MOSI	GND	20	GND
MISO	13	21	MISO	GPIO25	22	6
SCLK	14	23	SCLK	CE0	24	10
0V	GND	25	GND	CE1	26	11
IN_SDA	30	27	EED	EEC	28	31
GPIO21	21	29	GPIO5	GND	30	GND
GPIO22	22	31	GPIO6	GPIO12	32	26
GPIO23	23	33	GPIO13	GND	34	GND
GPIO24	24	35	GPIO19	GPIO16	36	27
GPIO25	25	37	GPIO26	GPIO20	38	28
0V	GND	39	GND	GPIO21	40	29

Connect the 40 pins of the Raspberry Pi to a breadboard according to the diagram below.

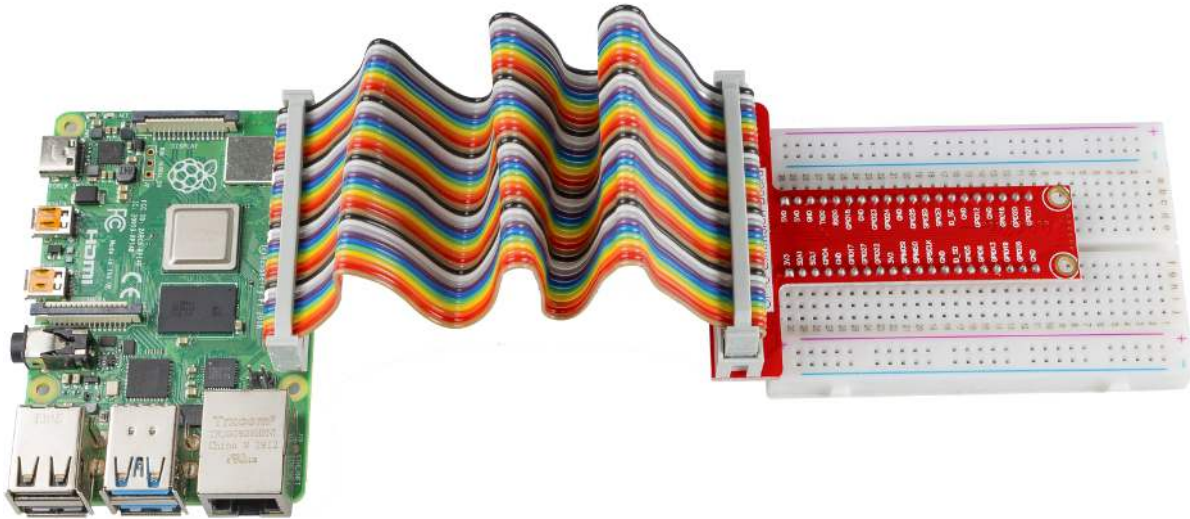

7.3 Obtain the IP Address of the Raspberry Pi

With a Screen

If you have a screen, it will be easy for you to get the IP address of Raspberry Pi.

Required Components	
Any Raspberry Pi	1 * Power Adapter
1 * Micro SD card	1 * Screen Power Adapter
1 * HDMI cable	1 * Screen
1 * Mouse	1 * Keyboard

1. Insert the micro-SD card with the Raspberry Pi OS image into the micro SD card slot on the underside of the Raspberry Pi.
2. Plug in the Mouse and Keyboard.
3. Connect the screen to the Raspberry Pi's HDMI port. Make sure the screen is plugged into a wall socket and turned on.

Note: For the Raspberry Pi 4 models, connect the screen to the HDMI0 port, nearest to the power-in socket.

4. Use the power adapter to power the Raspberry Pi. After a few seconds, the Raspberry Pi OS desktop will be displayed.
5. Hover the cursor over the WiFi icon, and the IP address of the Raspberry Pi will be displayed.



Without a Screen

After the Raspberry Pi is connected to WIFI, we need to get the IP address of it. There are many ways to know the IP address, and two of them are listed as follows.

1. Checking via the router

Check the addresses assigned to Raspberry Pi on the administration interface of the router.

The default hostname of the Raspberry Pi OS is raspberrypi. If you are using an ArchLinuxARM system, please find alarmpi.

2. Network Segment Scanning

Network scanning applications can be used to look up the IP address of Raspberry Pi, such as Advanced IP Scanner.

Scan the IP range set, and the names of all connected devices will be displayed. The default hostname of the Raspberry Pi OS is raspberrypi.

7.4 Use the SSH Remote Control

Bash is the standard default shell of Linux, and can be opened on the Raspberry Pi by using SSH. The Shell itself is a program written in C programming language that acts as a bridge linking the customers and Unix/Linux systems.

For Linux or/Mac OS X Users

Go to **Applications -> Utilities**, find the **Terminal**, and open it.

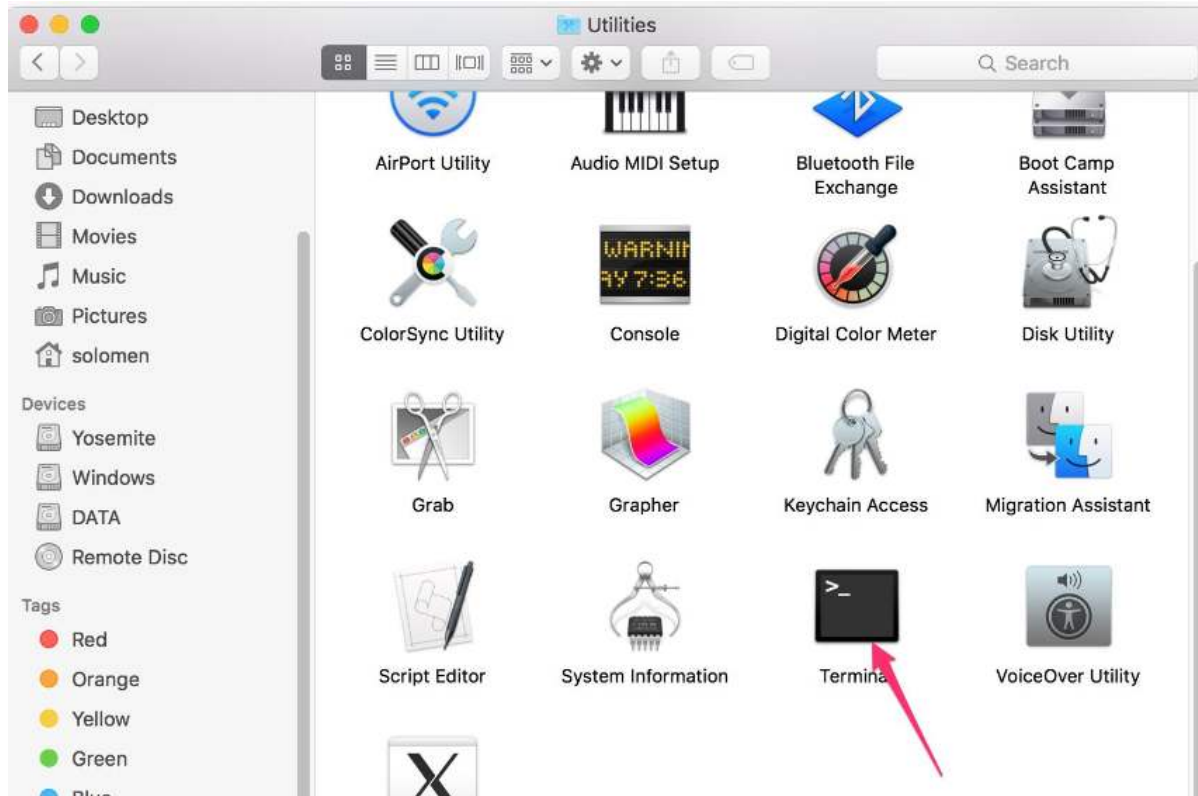

Type in `ssh pi@ip_address` where `pi` is the username and `ip_address` is the IP address of the Raspberry Pi. For example:

```
ssh pi@192.168.18.197
```

At the prompt, type `yes` in lowercase.

```
1. ssh pi@192.168.18.197 (ssh)
Last login: Fri Apr 12 16:56:20 on ttys000
# hang_chen @ hang-chendeMacBook-Pro in ~ [17:09:55]
$ ssh pi@192.168.18.197
The authenticity of host '192.168.18.197 (192.168.18.197)' can't be established.
ECDSA key fingerprint is SHA256:60tKKQtCCRvUCohWmvVcbp7tBHtQL0f8/0kusPjVsEU.
Are you sure you want to continue connecting (yes/no)?
```

The default password is `raspberrypi`.

Note: The characters do not display when typing in the password. Make sure to input the correct password.

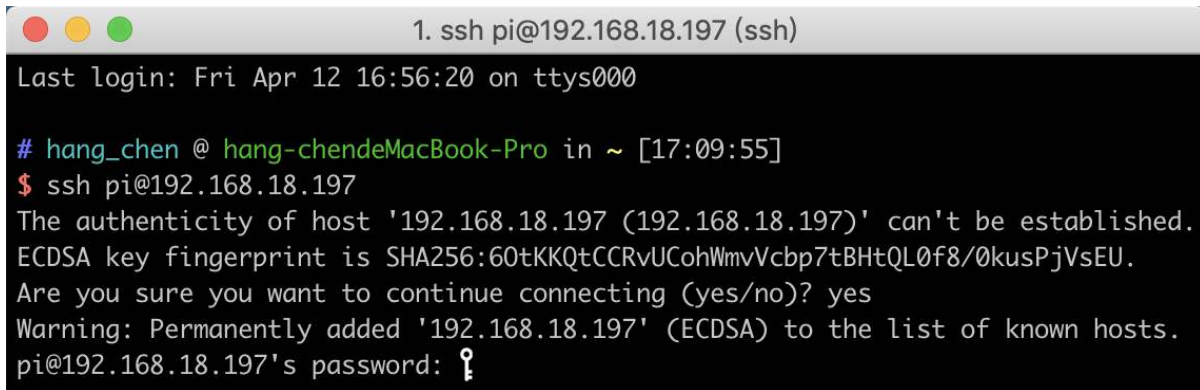

```
1. ssh pi@192.168.18.197 (ssh)
Last login: Fri Apr 12 16:56:20 on ttys000

# hang_chen @ hang-chendeMacBook-Pro in ~ [17:09:55]
$ ssh pi@192.168.18.197
The authenticity of host '192.168.18.197 (192.168.18.197)' can't be established.
ECDSA key fingerprint is SHA256:60tKKQtCCrvUCohWmvVcbp7tBHtQL0f8/0kusPjVsEU.
Are you sure you want to continue connecting (yes/no)? yes
Warning: Permanently added '192.168.18.197' (ECDSA) to the list of known hosts.
pi@192.168.18.197's password: █
```

We now get the Raspberry Pi connected and are ready to go to the next step.

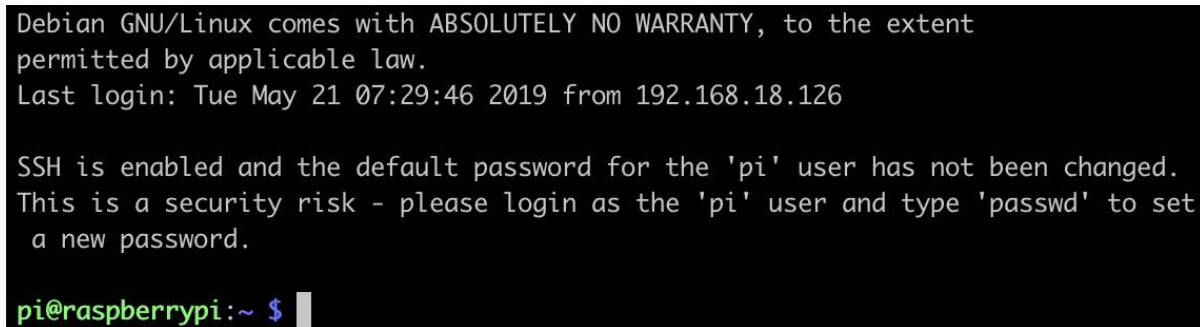

```
Debian GNU/Linux comes with ABSOLUTELY NO WARRANTY, to the extent
permitted by applicable law.
Last login: Tue May 21 07:29:46 2019 from 192.168.18.126

SSH is enabled and the default password for the 'pi' user has not been changed.
This is a security risk - please login as the 'pi' user and type 'passwd' to set
a new password.

pi@raspberrypi:~ $ █
```

For Windows Users

Windows users can use SSH with the PuTTY application.

Download PuTTY, open the application, and click Session on the left of the tree-like structure. Enter the IP address of the Raspberry Pi in the text box under Host Name, and enter 22 under Port.

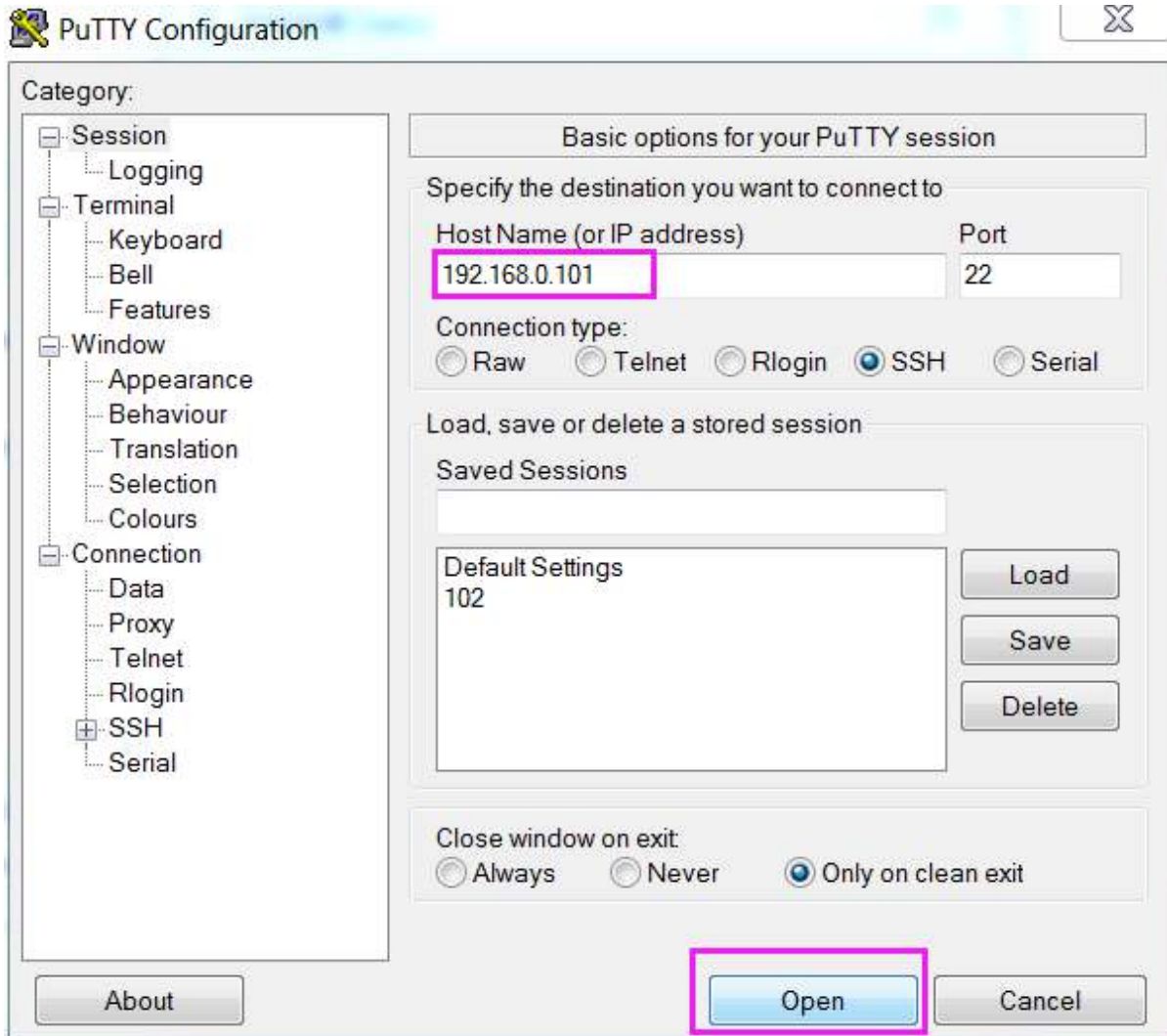

Click Open.

Note: When first logging in to the Raspberry Pi with the IP address, there will be a security prompt. Click Yes to continue.

When the PuTTY window prompts **login as:**, type in `pi` for the user name of the Raspberry Pi. The default password is `raspberry`.

Note: The characters do not display when typing in the password. Make sure to input the correct password.

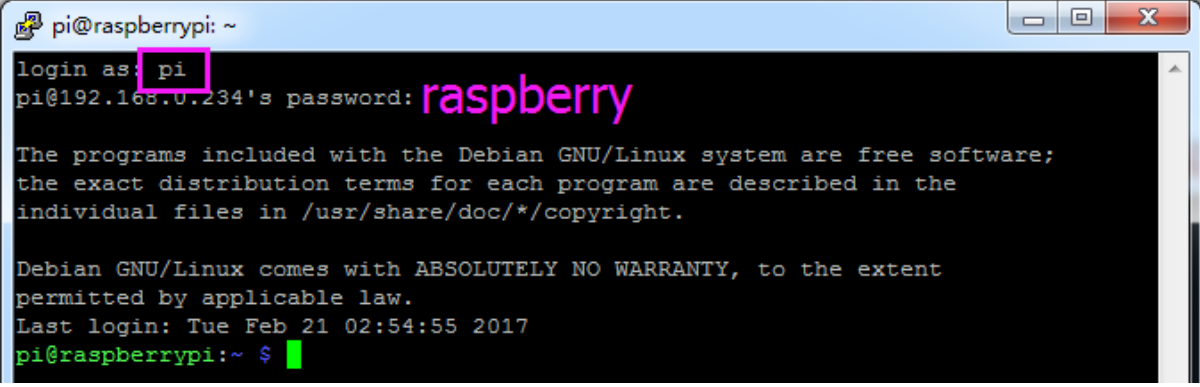
A terminal window titled "pi@raspberrypi: ~" with standard window controls. The terminal shows a login prompt "login as: pi" where "pi" is highlighted with a pink box. The password prompt "pi@192.168.0.234's password:" is followed by the password "raspberrypi" in pink. Below this, there is a copyright notice for Debian GNU/Linux and a login timestamp: "Last login: Tue Feb 21 02:54:55 2017". The prompt "pi@raspberrypi:~ \$" is shown at the bottom with a green cursor.

```
pi@raspberrypi: ~
login as: pi
pi@192.168.0.234's password: raspberrypi

The programs included with the Debian GNU/Linux system are free software;
the exact distribution terms for each program are described in the
individual files in /usr/share/doc/*/copyright.

Debian GNU/Linux comes with ABSOLUTELY NO WARRANTY, to the extent
permitted by applicable law.
Last login: Tue Feb 21 02:54:55 2017
pi@raspberrypi:~ $
```

Here, we get the Raspberry Pi connected and it is time to conduct the next steps.

PARAMETERS

8.1 General Information

Item of general information	Contents		Unit
LCD Display Size (Diagonal)	7		inch
Module Structure	CTP Touch + IPS LCD Display + PCB		-
LCD Display Type	TFT/TRANSMISSIVE		-
LCD Display Mode	Normally White		-
Viewing Direction	All		o'clock
Module Size (W×H×T)	165.30 × 121.00 × 7.75		mm
Active Area (W×H)	154.2144 × 85.92		mm
Number of Pixels(Resolution)	1024RGB × 600 IPS		pixel
Pixel Pitch (W×H)	0.1506 × 0.1412		mm
Color Pixel Arrangement	RGB Stripe		-
Module Interface Type	LCD Display	HDMI interface	-
	CTP Touch	USB interface	-
System Support	Win7/Win8/Win10 (Plug and play)		-
	Android/Linux (need to be configured first)		-
Power Supply	USB(5.0V)		-
Module Power Consumption	480(Typ.)		mA
Color Numbers	16.7M		-
Backlight Type	White LED		-

8.2 Absolute Maximum Ratings

Parameter of absolute maximum ratings	Symbol	Min	Max	Unit
Operating Temperature	Top	-10	60	°C
Storage Temperature	T _{st}	-20	70	°C
Humidity	RH	-	90%(Max 60°C)	RH

Note: Absolute maximum rating means that the product can withstand short-term, not more than 120 hours. If the product takes a long time to withstand these conditions, the life time would be shorter.

Parameter of DC characteristics	Symbol	Min.	Typ	Max.	Unit
PCB Operating Voltage	VUSB	-	5.0	-	V
LCD I/O Operating Voltage	VDD	3.0	3.3	3.6	V
Input Voltage 'H' Level	VIH	0.7*VDD	-	VDD	V
Input Voltage 'L' Level	VIL	VSS	-	0.3*VDD	V
Output Voltage 'H' Level	VOH	VDD-0.4	-	VDD	V
Output Voltage 'L' Level	VOL	VSS	-	VSS+0.4	V

8.3 CTP Characteristics

Item of CTP characteristics	Specification	Unit	Remark
Panel Type	Glass Cover + Glass Sensor	-	-
Resolution	1024 × 600	pixel	-
Surface Hardness	≥6H	-	-
Transparency	> 82%	-	-
Driver IC	-	-	-
Interface Type	USB	-	-
Support Points	5	-	-
Sampling Rate	20~100	Hz	-
Supply voltage	3.3	V	-

8.4 Interface Description

Symbol	DESCRIPTION
VUSB	USB Power
D-	USB Data-
D+	USB Data+
NC	No Connection
GND	Power Ground

8.5 HDMI Interface Description

NO.	Symbol	DESCRIPTION
1	TMDS Data2+	Positive side of channel 2 TMDS low-voltage signal differential input pair
2	TMDS Data2 Shield	Ground
3	TMDS Data2-	Negative side of channel 2 TMDS low-voltage signal differential input pair
4	TMDS Data1+	Positive side of channel 1 TMDS low-voltage signal differential input pair
5	TMDS Data1 Shield	Ground
6	TMDS Data1-	Negative side of channel 1 TMDS low-voltage signal differential input pair
7	TMDS Data0+	Positive side of channel 0 TMDS low-voltage signal differential input pair
8	TMDS Data 0 Shield	Ground
9	TMDS Data0-	Negative side of channel 0 TMDS low-voltage signal differential input pair
10	TMDS Clock+	Positive side of reference clock. TMDS low-voltage signal differential input pair
11	TMDS Clock Shield	Ground
12	TMDS Clock-	Negative side of reference clock. TMDS low-voltage signal differential input pair
13	CEC	No Connection

14	Reserved(N.C.)	No Connection
15	SCL	DDC SCL
16	SDA	DDC SDA
17	DDC/CEC Ground	Ground
18	+5V Power	+5V Power
19	Hot Plug Detect	Hot Plug Detect

USB Interface Description Application Note: Please connect the USB first, and then connect the HDMI interface.

8.6 Reliability Conditions

No.	Test Item	Test Condition
1	High Temperature Storage	70°C/120 hours
2	Low Temperature Storage	-20°C/120 hours
3	High Temperature Operating	60°C/120 hours
4	Low Temperature Operating	-10°C/120 hours
5	Temperature Cycle Storage	-10°C(30min.)~25(5min.)~60°C(30min.)× 10cycles

A. Inspection after test:
Inspection after 2~4 hours storage at room temperature, the sample shall be free from defects:

- Air bubble in the LCD;
- Seal leak;
- Non-display;
- Missing segments;
- Glass crack;
- Current is twice higher than initial value.

B. Remark:

- The test samples should be applied to only one test item.
- Sample size for each test item is 5~10pcs.
- Failure Judgment Criterion: Basic Specification, Electrical Characteristic, Mechanical Characteristic, Optical Characteristic.

FAQ

1. **The colored picture appears in black and white.**

A: Please check whether the saturation, brightness and contrast under the Color menu are adjusted properly.

2. **No picture is displayed on the screen after the device powers on.**

A: Please check whether the HDMI output port is plugged properly. And also please make sure the suitable adapter is connected to the LCD displayed.

3. **The picture is distorted in color or displayed with color abnormality like a certain color missing.**

A: Please check whether the signal wire is plugged in a good way. If the wire is defective or the wiring is loose, the signal transmission may be influenced, thus causing the fault.

4. **There appears stripe interference on the display and the picture is dark.**

A: Please check whether the socket and the plug are in good contact.

5. **The LCD cannot be turned on when no other equipment is connected.**

A: This is normal, please use it after connecting Raspberry Pi or other devices.

COPYRIGHT NOTICE

All contents including but not limited to texts, images, and code in this manual are owned by the SunFounder Company. You should only use it for personal study, investigation, enjoyment, or other non-commercial or nonprofit purposes, under the related regulations and copyrights laws, without infringing the legal rights of the author and relevant right holders. For any individual or organization that uses these for commercial profit without permission, the Company reserves the right to take legal action.