



# SAW COMPONENTS

## Series/Type: J3353K

The following products presented in this data sheet are being withdrawn.

Ordering Code	Substitute Product	Date of Withdrawal	Deadline Last Orders	Last Shipments
B39389J3353K100	K3953M + K9353M	2008-01-18	2008-06-30	2008-09-30

For further information please contact your nearest EPCOS sales office, which will also support you in selecting a suitable substitute. The addresses of our worldwide sales network are presented at [www.epcos.com/sales](http://www.epcos.com/sales).

**SAW Components**
**J 3353 K**
**IF Filter for Quasi/Split Sound Applications**
**38,90 MHz**
**Data Sheet**
**Standard**

- I
- D/K

**Features**

- TV IF filter for quasi/split sound applications (separate picture and sound channel)
- Picture channel with Nyquist slope and sound suppression
- Customized group delay predistortion
- Sound channel with passband for sound carriers at 32,90 MHz and 32,35 MHz (NICAM)
- Suitable for CENELEC EN 55020

**Terminals**

- Tinned CuFe alloy

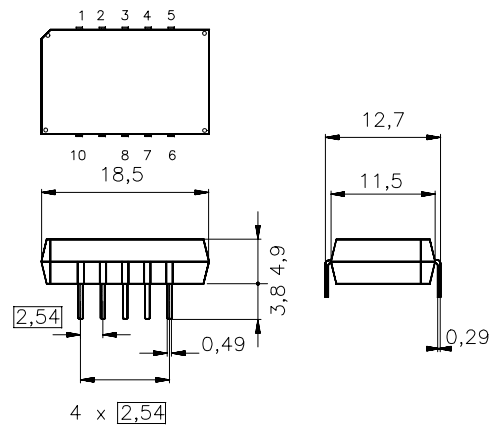
 Plastic package **DIP10K**

Dimensions in mm, approx. weight 1,8 g

**Pin configuration**

- |      |                       |
|------|-----------------------|
| 1    | Input                 |
| 2    | Input - ground        |
| 3; 8 | Chip carrier - ground |
| 4; 5 | Output - sound        |
| 6; 7 | Output - picture      |
| 9    | Free                  |
| 10   | Not connected         |

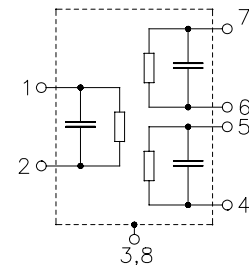

Type	Ordering code	Marking and package according to	Packing according to
J 3353 K	B39389-J3353-K100	C61157-A2-A3	F61074-V8068-Z000

**Maximum ratings**

Operable temperature range	$T_A$	-25/+65	°C	
Storage temperature range	$T_{stg}$	-25/+85	°C	
DC voltage	$V_{DC}$	5	V	between any terminals
AC voltage	$V_{pp}$	10	V	between any terminals

**SAW Components**
**J 3353 K**
**IF Filter for Quasi/Split Sound Applications**
**38,90 MHz**
**Data Sheet**
**Characteristics of picture channel**

Reference temperature:  $T_A = 25\text{ °C}$   
 Terminating source impedance:  $Z_S = 50\ \Omega$   
 Terminating load impedance:  $Z_L = 2\text{ k}\Omega \parallel 3\text{ pF}$

		min.	typ.	max.	
<b>Insertion attenuation</b>					
	$\alpha$				
Reference level for the following data	37,40 MHz	12,9	14,4	15,9	dB
<b>Relative attenuation</b>					
	$\alpha_{rel}$				
Picture carrier	38,90 MHz	5,0	6,0	7,0	dB
Color carrier	34,47 MHz	-0,6	0,4	1,4	dB
Sound carrier	32,90 MHz	40,0	52,0	—	dB
	32,35 MHz	44,0	56,0	—	dB
	31,40 MHz	48,0	60,0	—	dB
Adjacent picture carrier	30,90 MHz	50,0	62,0	—	dB
	30,40 MHz	48,0	60,0	—	dB
	30,40 MHz	48,0	60,0	—	dB
Adjacent sound carrier	40,90 MHz	45,0	55,0	—	dB
	40,35 MHz	43,0	53,0	—	dB
	40,35 MHz	43,0	53,0	—	dB
Lower sidelobe	25,00 ... 30,90 MHz	46,0	54,0	—	dB
Upper sidelobe	40,90 ... 45,00 MHz	39,0	45,0	—	dB
<b>Reflected wave signal suppression</b>					
1,2 $\mu$ s ... 6,0 $\mu$ s after main pulse (test pulse 250 ns, carrier frequency 37,40 MHz)		42,0	55,0	—	dB
<b>Feedthrough signal suppression</b>					
1,2 $\mu$ s ... 1,1 $\mu$ s before main pulse (test pulse 250 ns, carrier frequency 37,40 MHz)		50,0	56,0	—	dB
<b>Group delay predistortion</b>					
(reference frequency 38,90 MHz)					
	$\Delta\tau$				
	38,90 MHz	—	0	—	ns
	34,47 MHz	—	-50	—	ns
<b>Impedance at 37,40 MHz</b>					
Input: $Z_{IN} = R_{IN} \parallel C_{IN}$		—	1,2 $\parallel$ 24,0	—	k $\Omega$ $\parallel$ pF
Output: $Z_{OUT} = R_{OUT} \parallel C_{OUT}$		—	2,5 $\parallel$ 3,6	—	k $\Omega$ $\parallel$ pF
<b>Temperature coefficient of frequency</b>					
	$TC_f$	—	-72	—	ppm/K

**Data Sheet**
**Characteristics of sound channel**

Reference temperature:  $T_A = 25\text{ °C}$   
 Terminating source impedance:  $Z_S = 50\ \Omega$   
 Terminating load impedance:  $Z_L = 2\text{ k}\Omega \parallel 3\text{ pF}$

		<b>min.</b>	<b>typ.</b>	<b>max.</b>	
<b>Insertion attenuation</b>					
	$\alpha$				
Reference level for the following data	32,35 MHz	10,4	11,9	13,4	dB
<b>Relative attenuation</b>					
	$\alpha_{rel}$				
Sound carrier	32,90 MHz	-0,5	0,5	1,5	dB
	31,95 MHz	—	2,5	—	dB
Picture carrier	38,90 MHz	46,0	58,0	—	dB
Color carrier	34,47 MHz	33,0	47,0	—	dB
Adjacent picture carrier	30,90 MHz	40,0	51,0	—	dB
Adjacent sound carrier	40,90 MHz	48,0	59,0	—	dB
	40,35 MHz	46,0	55,0	—	dB
Lower sidelobe	25,00 ... 30,90 MHz	39,0	45,0	—	dB
Upper sidelobe	38,90 ... 45,00 MHz	44,0	50,0	—	dB
<b>Impedance</b> at 32,35 MHz					
	Output: $Z_{OUT} = R_{OUT} \parallel C_{OUT}$	—	2,5 $\parallel$ 3,6	—	k $\Omega$ $\parallel$ pF
<b>Temperature coefficient of frequency</b>					
	$TC_f$	—	-72	—	ppm/K

Data Sheet

Frequency response of picture channel

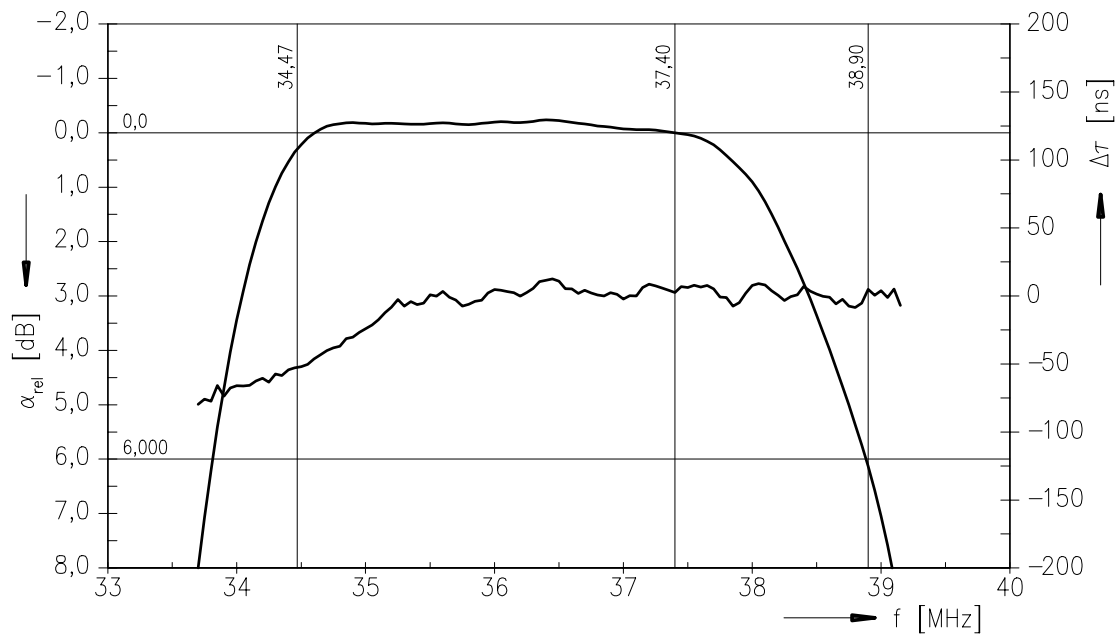
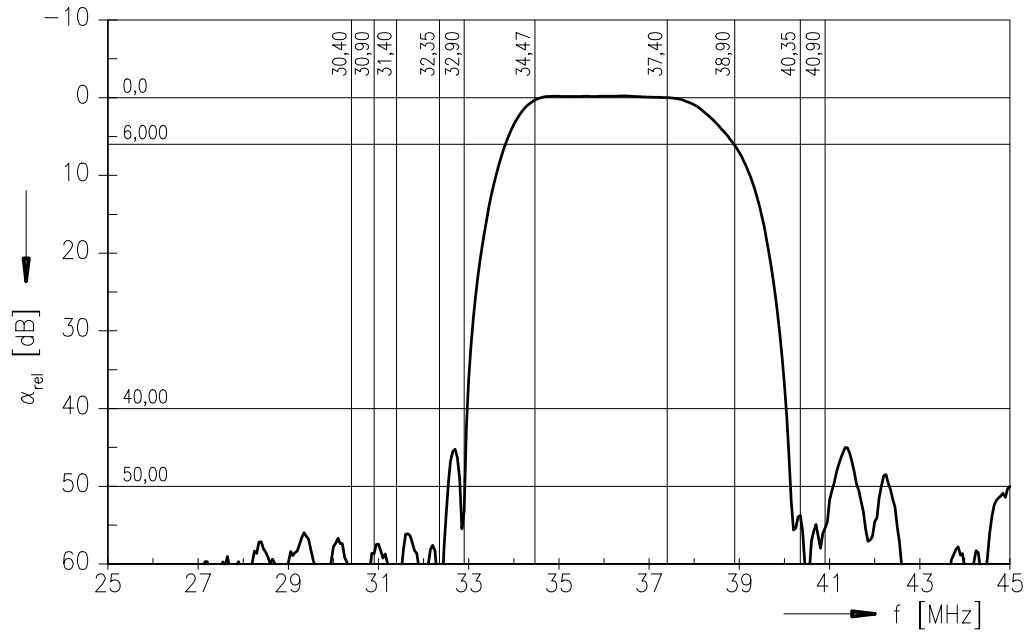

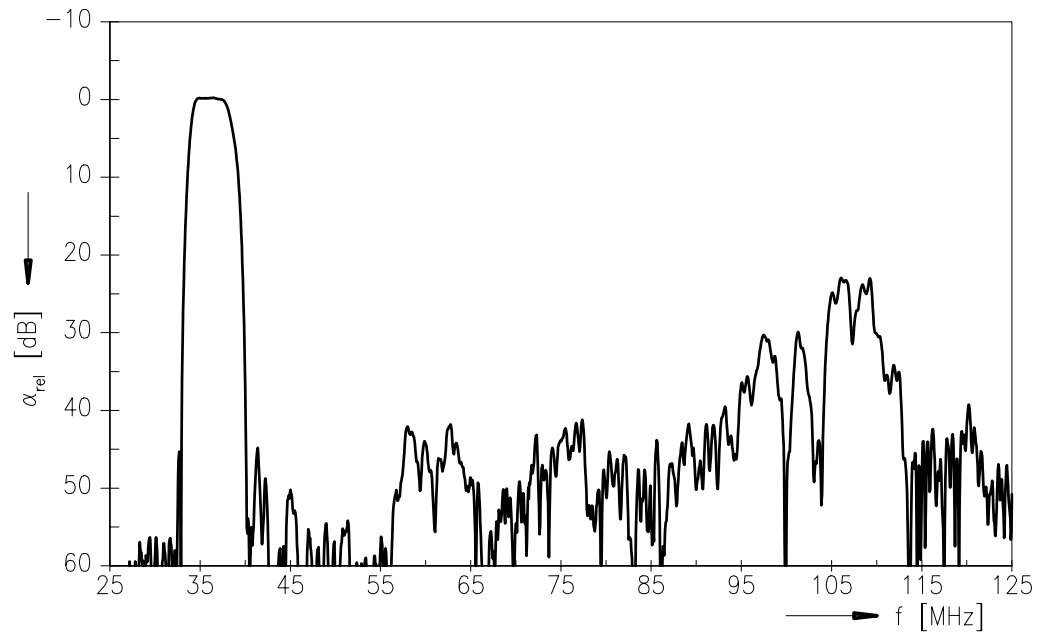
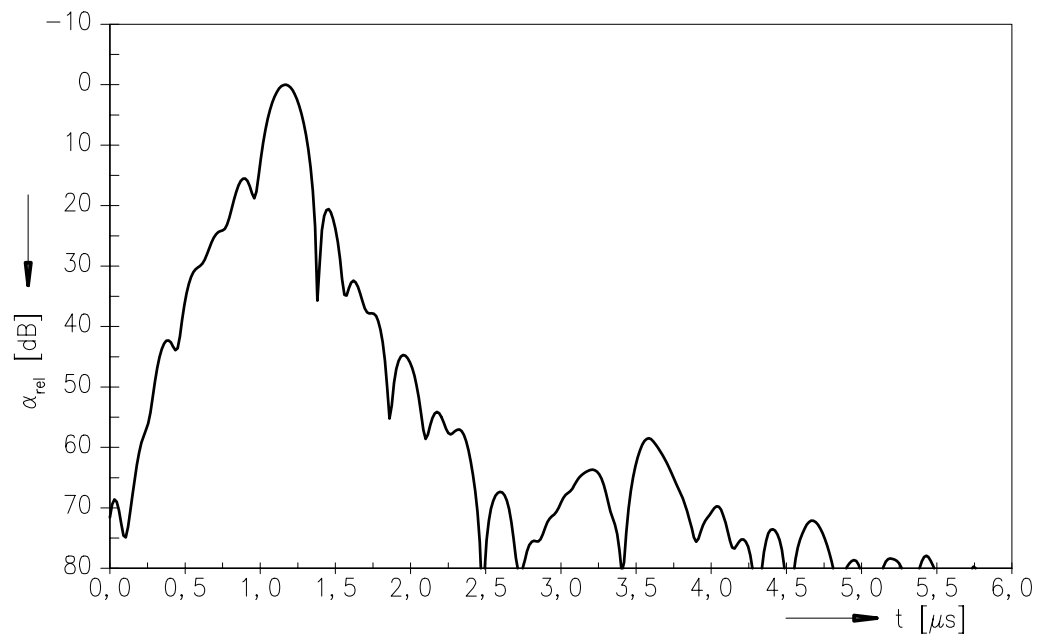
**Data Sheet**
**Frequency response of picture channel**

**Time domain response of picture channel**

Data Sheet

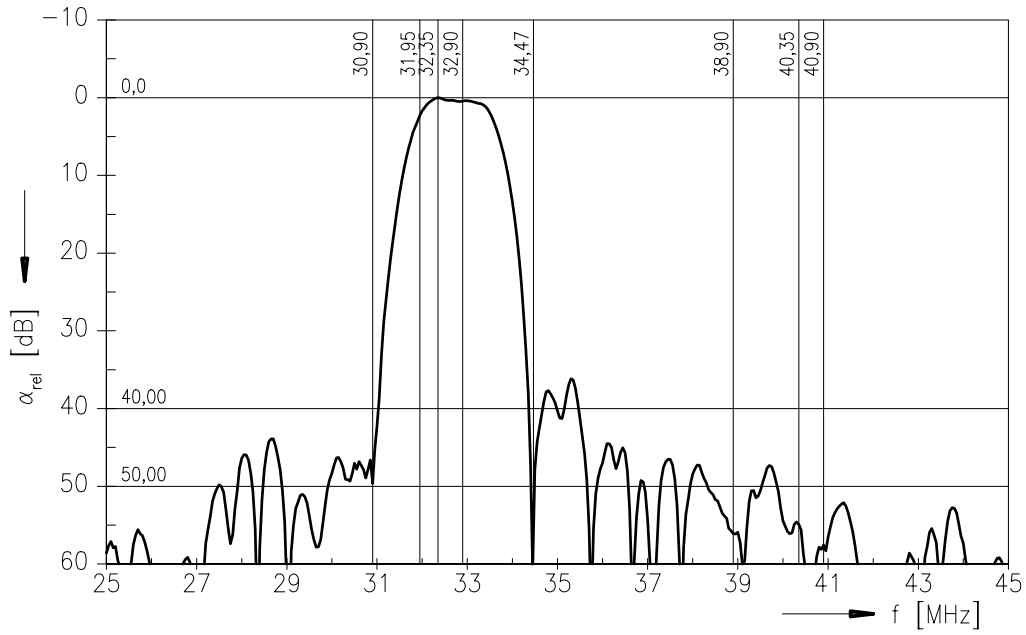
Frequency response of sound channel



**Published by EPCOS AG****Surface Acoustic Wave Components Division, SAW CE MM PD****P.O. Box 80 17 09, D-81617 München**

© EPCOS AG 2001. All Rights Reserved.

As far as patents or other rights of third parties are concerned, liability is only assumed for components per se, not for applications, processes and circuits implemented within components or assemblies.

The information describes the type of component and shall not be considered as assured characteristics.

Terms of delivery and rights to change design reserved.

For questions on technology, prices and delivery please contact the sales offices of EPCOS AG or the international representatives.

Due to technical requirements components may contain dangerous substances. For information on the type in question please also contact one of our sales offices.