

Slotted Optical Switch OPB202

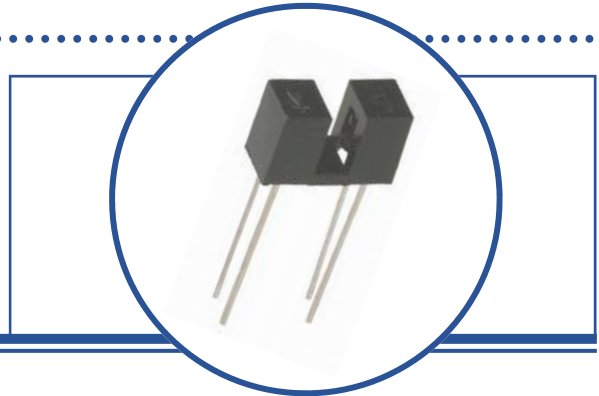

Features:

- Opaque housing
- Inexpensive plastic housing
- 0.110" (2.79 mm) gap small profile slotted switch
- Customization available



Description:

OPB202 consists of an infrared Light Emitting Diode (LED) and an NPN silicon phototransistor mounted on opposite sides of a 0.110 (2.79 mm) slot in an opaque plastic housing. Switching of the phototransistor occurs whenever an opaque object to light wave lengths between 400nm and 1100 nm passes through the slot. The lens on both the LED and phototransistor is 0.6" [1.5 mm] in diameter resulting in an equivalent aperture of 0.6" [1.5 mm].

Custom electrical, wire and cabling and connectors are available. Contact your local representative or OPTEK for more information.

Applications:

- Non-contact interruptive object sensing
- Assembly line automation
- Machine automation
- Equipment security
- Machine safety

Ordering Information			
Part Number	LED Peak Wavelength	Sensor	Aperture Emitter/Sensor
OPB202	940 nm	Transistor	.06 [1.5] / .06 [1.5]

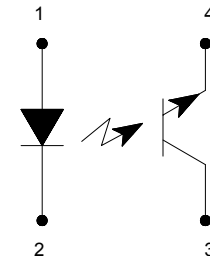
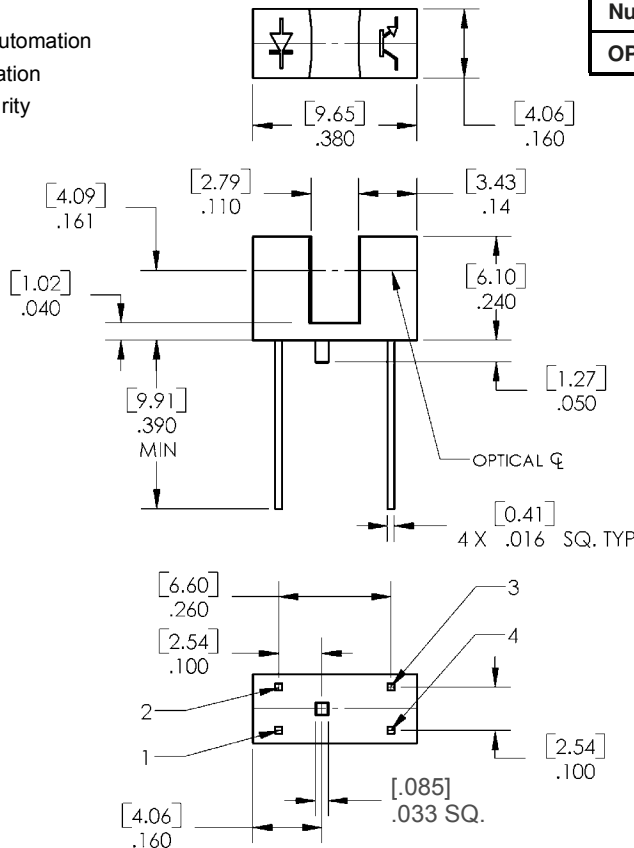

Pin #	Description
1	Anode
2	Cathode
3	Collector
4	Emitter

DIMENSIONS ARE IN INCHES AND [MILLIMETERS].
TOLERANCES ARE ±.01 [0.25].



RoHS

OPTEK reserves the right to make changes at any time in order to improve design and to supply the best product possible.

Absolute Maximum Ratings ($T_A=25^{\circ}\text{C}$ unless otherwise noted)

Storage & Operating Temperature Range	-25°C to +85°C
Lead Soldering Temperature [1/16 inch (1.6mm) from the case for 5 sec. with soldering iron] ⁽¹⁾	260°C

Input Diode

Forward DC Current	50 mA
Peak Forward Current (1 μs pulse width, 300 pps)	1 A
Reverse DC Voltage	2 V
Power Dissipation ⁽²⁾	75 mW

Output Phototransistor

Collector-Emitter Voltage	30 V
Emitter-Collector Voltage	5 V
Collector DC Current	20 mA
Power Dissipation ⁽²⁾	100 mW

Electrical Characteristics ($T_A = 25^{\circ}\text{C}$ unless otherwise noted)

SYMBOL	PARAMETER	MIN	TYP	MAX	UNITS	TEST CONDITIONS
--------	-----------	-----	-----	-----	-------	-----------------

Input Diode

V_F	Forward Voltage	-	-	1.6	V	$I_F = 20 \text{ mA}$
I_R	Reverse Current	-	-	100	μA	$V_R = 2.0 \text{ V}$

Output Phototransistor

$V_{(BR)CEO}$	Collector-Emitter Breakdown Voltage	30	-	-	V	$I_C = 1 \text{ mA}$
$V_{(BR)ECO}$	Emitter-Collector Breakdown Voltage	5	-	-	V	$I_E = 100 \mu\text{A}$
I_{CEO}	Collector Dark Current	-	-	100	nA	$V_{CE} = 10 \text{ V}, I_F = 0, E_E = 0$
t_r	Rise Time	-	3	15	μs	$V_{CE} = 5 \text{ V}, I_C = 2 \text{ mA}, R_L = 100 \Omega$
t_f	Fall Time	-	4	20	μs	

Combined

$V_{CE(SAT)}$	Collector-Emitter Saturation Voltage	-	-	0.4	V	$I_C = 2.5 \text{ mA}, I_F = 20 \text{ mA}$
$I_{C(ON)}$	On-State Collector Current	5.0	-	-	mA	$V_{CE} = 5 \text{ V}, I_F = 20 \text{ mA}$

Notes:

- (1) RMA flux is recommended. Duration can be extended to 10 seconds maximum when flow soldering.
- (2) Derate linearly 1.67 mW/°C above 25 ° C.
- (3) All parameters tested using pulse techniques.
- (4) Methanol or isopropanol are recommended as cleaning agents. Plastic housing is soluble in chlorinated hydrocarbons and ketones.

OPTEK reserves the right to make changes at any time in order to improve design and to supply the best product possible.

OPB202 - Flag Next to Emitter

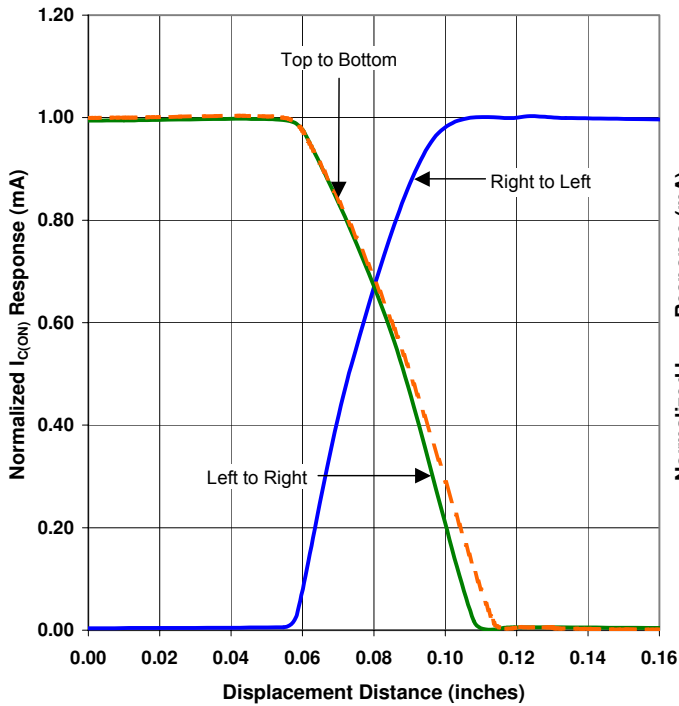

OPB202 - Flag Next to Sensor

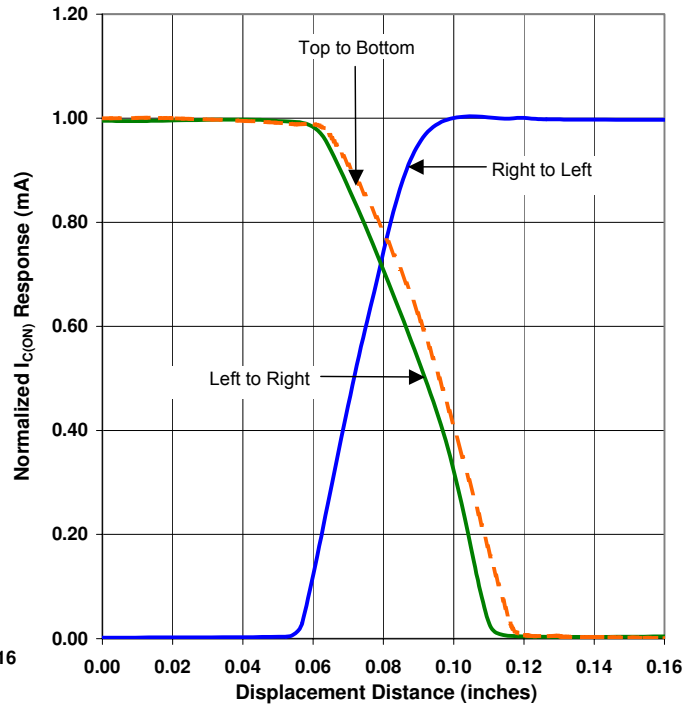

OPB202 - Flag in Middle of Slot

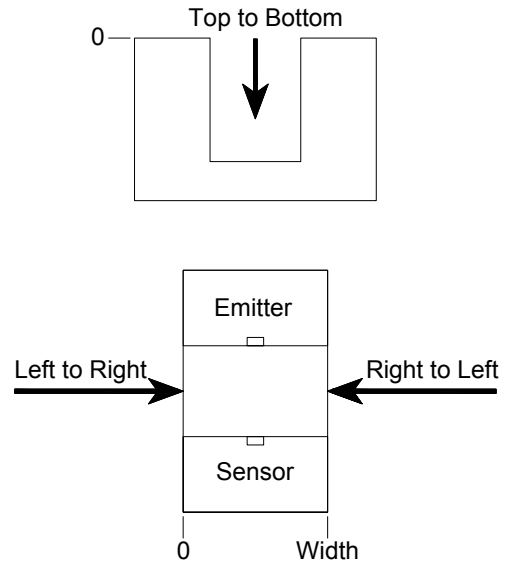
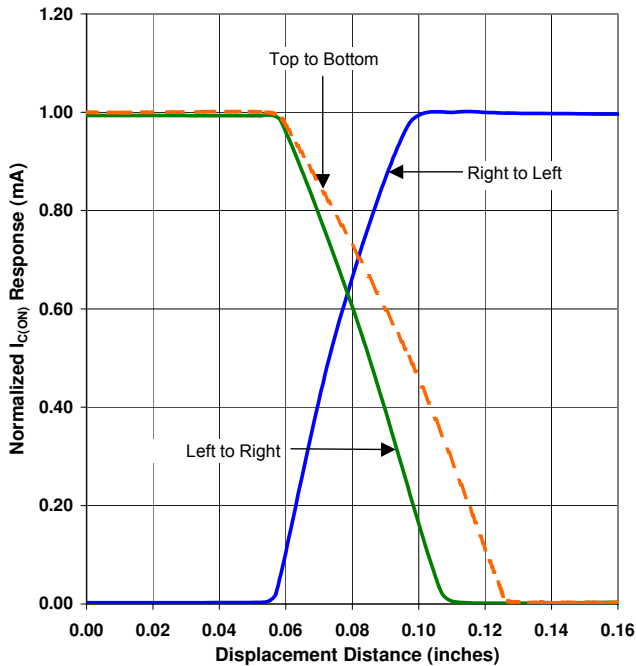

OPTEK reserves the right to make changes at any time in order to improve design and to supply the best product possible.

OPB202 - Power Dissipation vs Ambient Temperature

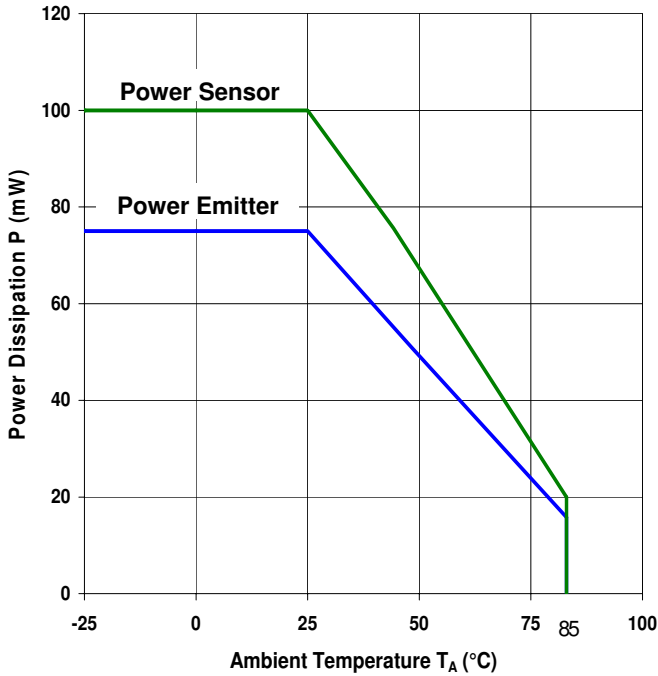

OPB202 - Forward Current vs Forward Voltage

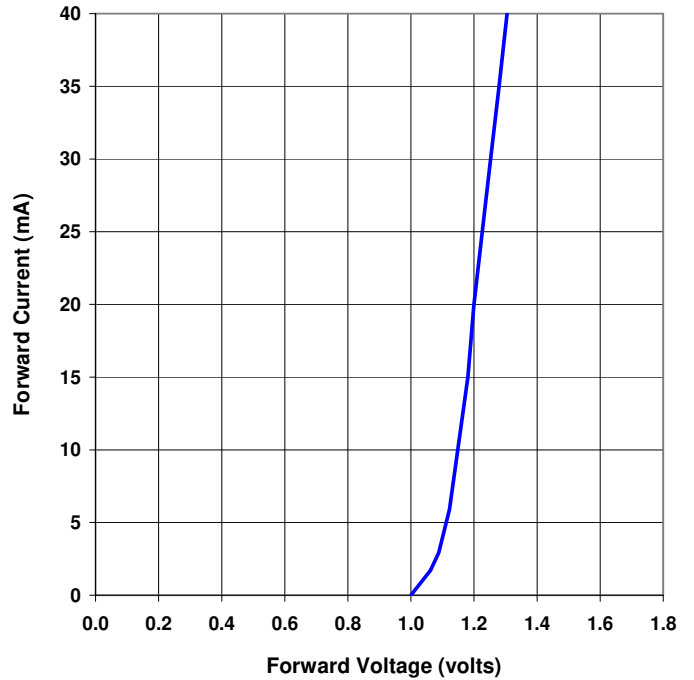

OPB202 - Collector Current vs Collector-Emitter Voltage

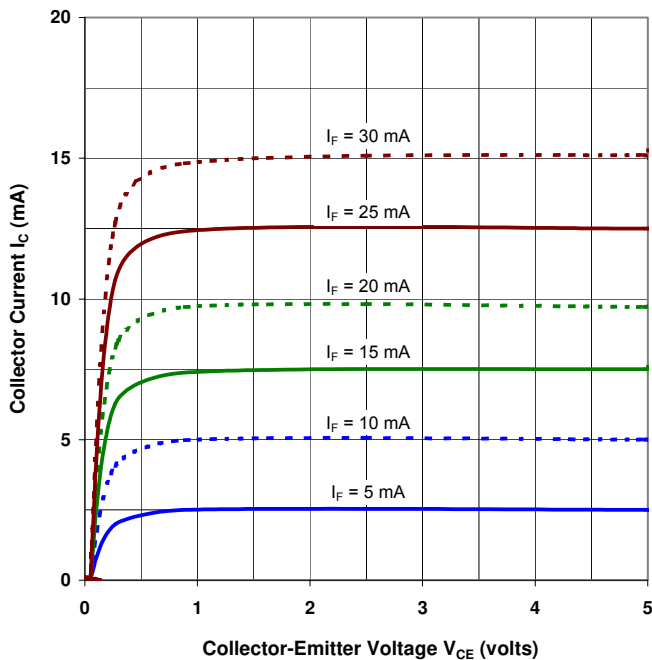

OPB202 - Collector Current vs Ambient Temperature

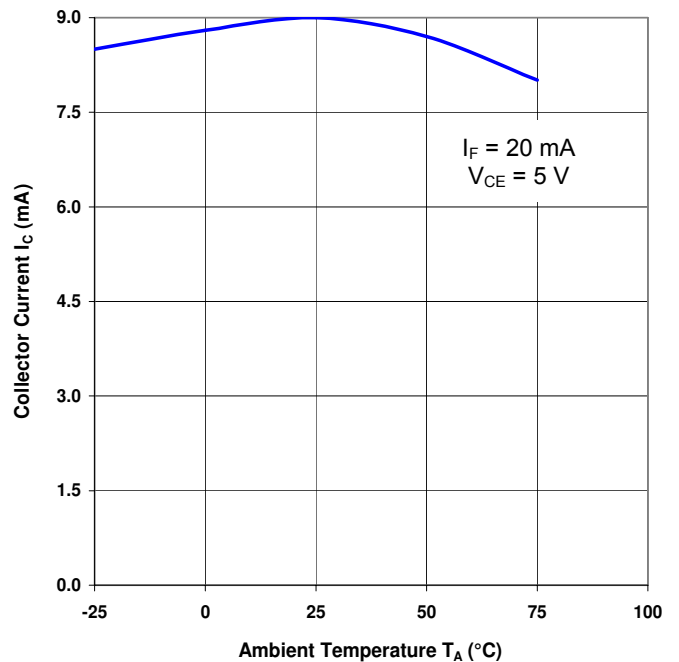

OPTEK reserves the right to make changes at any time in order to improve design and to supply the best product possible.

Response Time vs. Load Resistance

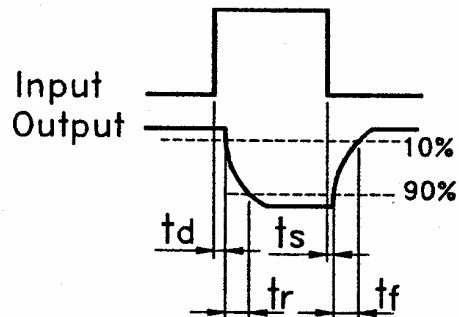
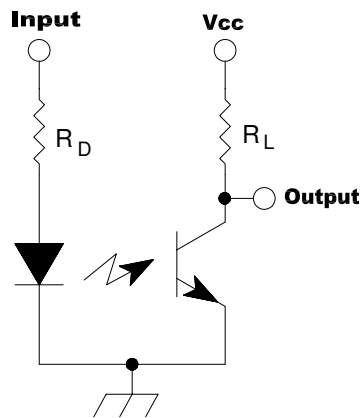
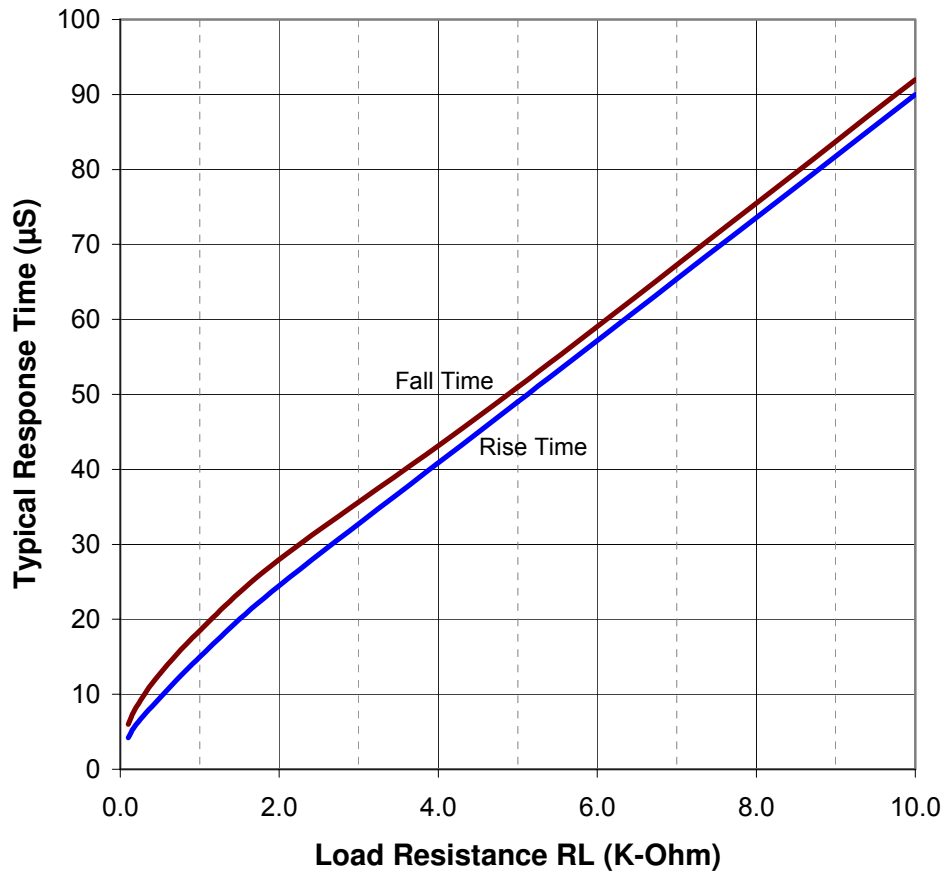

OPTEK reserves the right to make changes at any time in order to improve design and to supply the best product possible.