

CDBT0230-HF

Reverse Voltage: 30 Volts

Forward Current: 200 mA

RoHS Device

Halogen Free

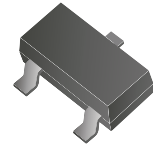

Features

- Small surface mounting type.
- Low I_R ($I_R=10\mu A$ Typ.)
- High reliability.

Mechanical data

- Case: SOT-23, molded plastic.
- Terminals: Solderable per MIL-STD-750, method 2026.

Circuit diagram

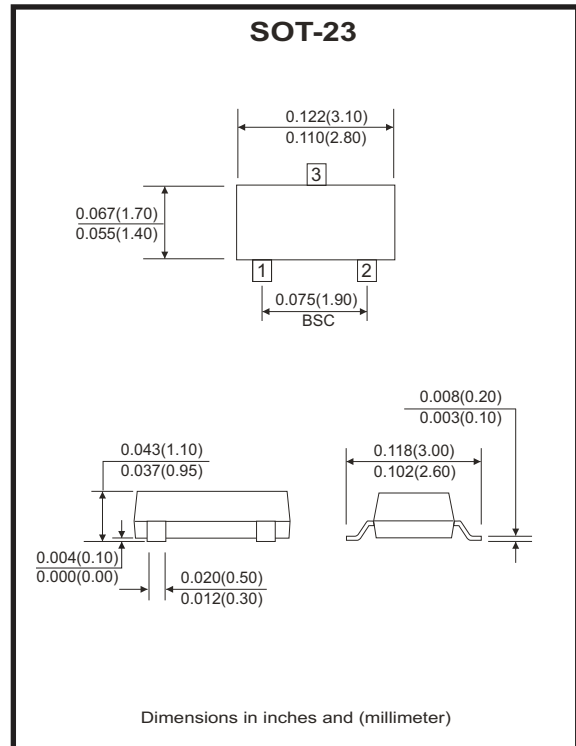
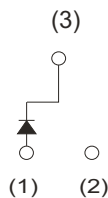

Maximum Ratings and Electrical Characteristics

(at $T_a=25^\circ C$ unless otherwise noted)

Parameter	Symbol	Value	Units
Maximum recurrent peak reverse voltage	V_{RRM}	30	V
Maximum RMS voltage	V_{RMS}	21	V
Maximum DC blocking voltage	V_{DC}	30	V
Maximum average forward rectified current	I_o	0.2	A
Peak forward surge current at 8.3m sec single half sine-wave	I_{FSM}	3.0	A
Maximum instantaneous forward voltage at $I_F=0.2A$	V_F	0.5	V
Maximum average reverse current at $V_R(1)=30V$	$I_{R(1)}$	5	μA
Maximum average reverse current at $V_R(2)=10V$	$I_{R(2)}$	1	μA
Typical junction capacitance between terminal (Note 1)	C_J	40	pF
Maximum operating temperature range	T_J	-55 to +125	$^\circ C$
Storage temperature range	T_{STG}	-55 to +125	$^\circ C$

Notes: 1. Measured at 1.0MHz and 0 reverse bias voltage.
2. ESD sensitive product handling required.

Company reserves the right to improve product design , functions and reliability without notice.

REV: B

RATING AND CHARACTERISTIC CURVES (CDBT0230-HF)

Fig.1 - Forward Characteristics

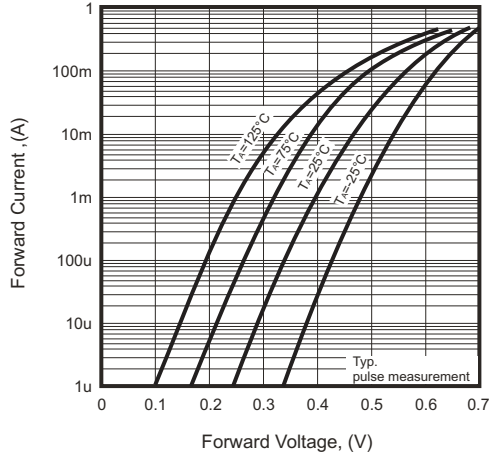

Fig.2 - Reverse Characteristics

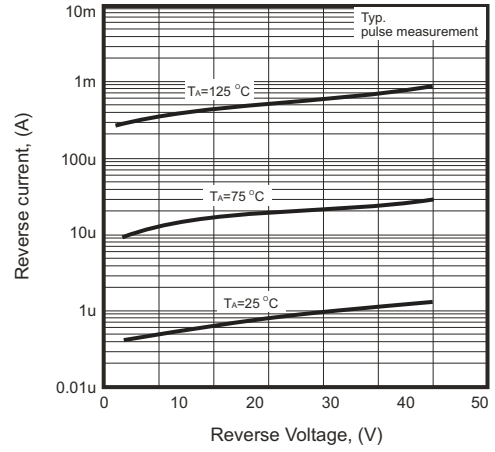

Fig.3 - Typical Junction Capacitance

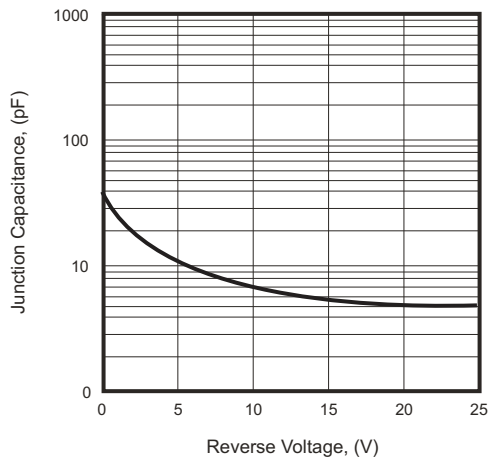
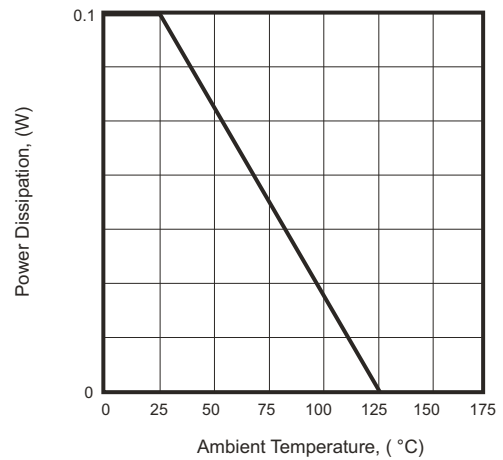
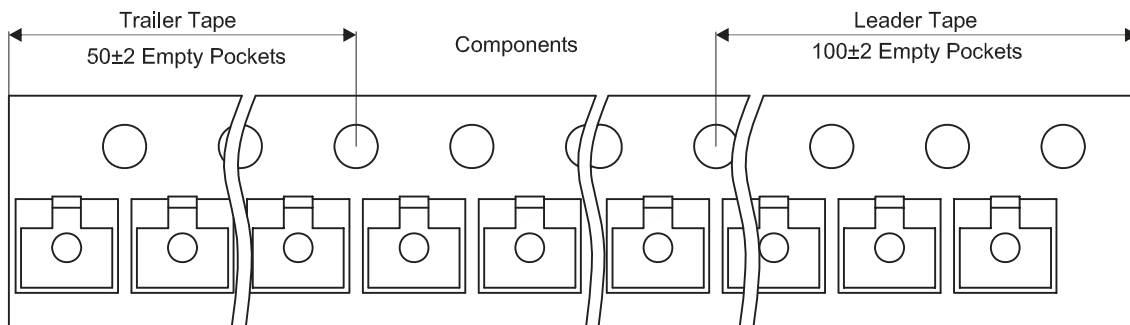
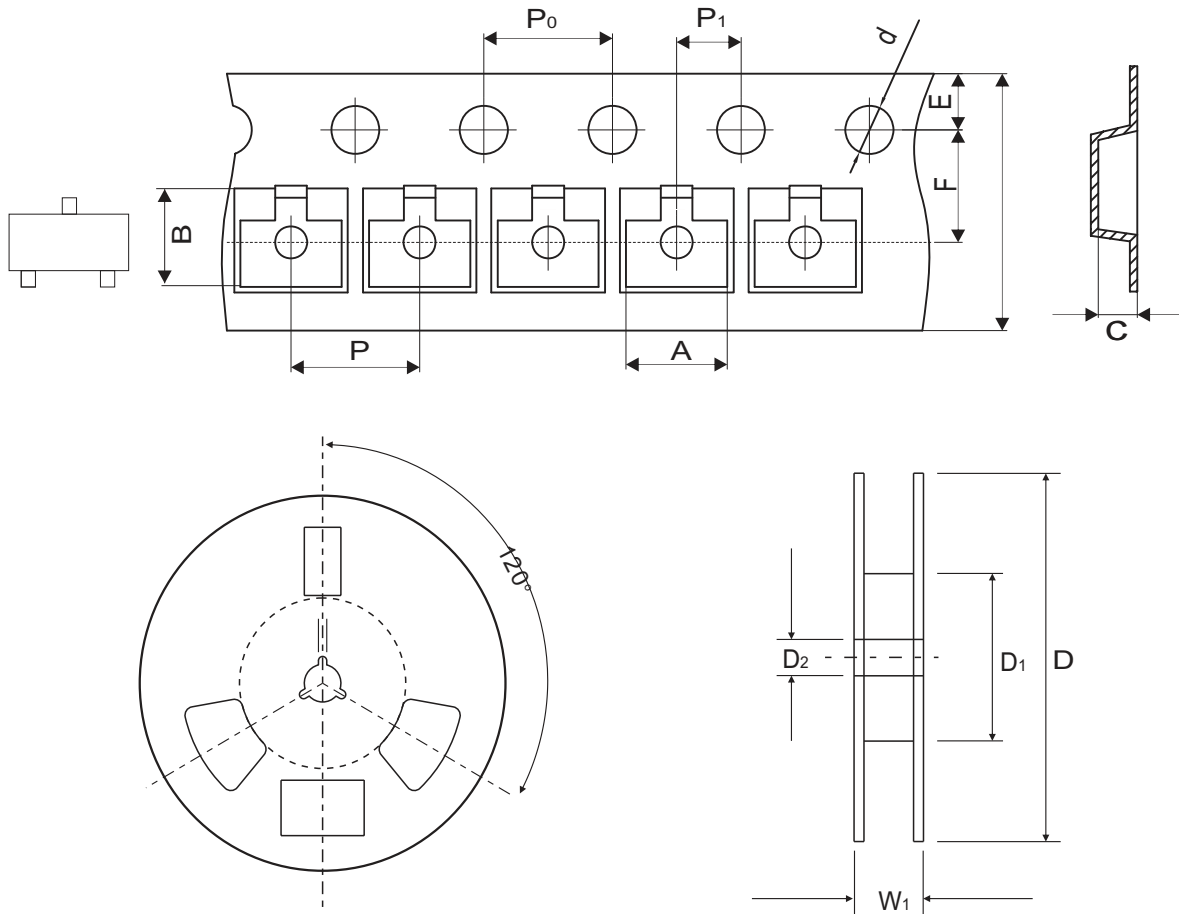

Fig.4 - Forward Power Dissipation Characteristics



Reel Taping Specification



SOT-23	SYMBOL	A	B	C	d	D	D ₁	D ₂
	(mm)	3.15 ± 0.10	3.15 ± 0.10	1.30 ± 0.10	1.55 ± 0.05	180.00 + 0.00 - 3.00	60.00 + 1.00 - 0.40	13.00 ± 0.20
	(inch)	0.124 ± 0.004	0.124 ± 0.004	0.051 ± 0.004	0.061 ± 0.002	7.087 + 0.000 - 0.118	2.362 + 0.039 - 0.016	0.512 ± 0.008

SOT-23	SYMBOL	E	F	P	P ₀	P ₁	W	W ₁
	(mm)	1.75 ± 0.10	3.50 ± 0.05	4.00 ± 0.10	4.00 ± 0.10	2.00 ± 0.05	8.00 ± 0.20	11.40 ± 1.00
	(inch)	0.069 ± 0.004	0.138 ± 0.002	0.157 ± 0.004	0.157 ± 0.004	0.079 ± 0.002	0.315 ± 0.008	0.449 ± 0.039

Company reserves the right to improve product design, functions and reliability without notice.

Marking Code

Part Number	Marking Code
CDBT0230-HF	05H

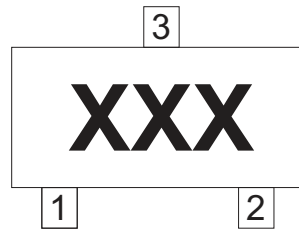

xxx = Product type marking code

Suggested PAD Layout

SIZE	SOT-23	
	(mm)	(inch)
A	0.90	0.035
B	0.80	0.031
C	1.90	0.075
D	2.20	0.087
E	3.10	0.122

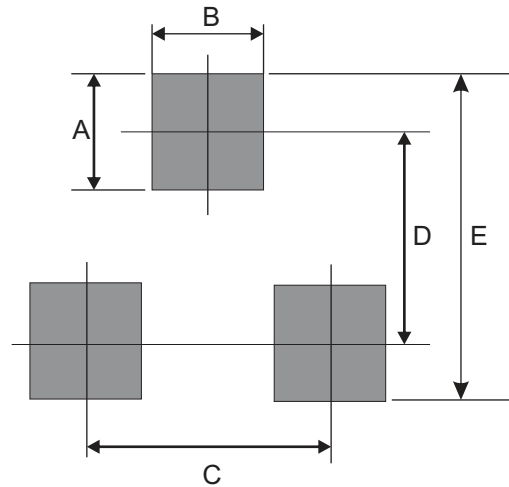

Standard Packaging

Case Type	Qty Per Reel	Reel Size
	(Pcs)	(inch)
SOT-23	3,000	7