

M68ICS05COM/D

April 1998

**M68ICS05C
HC705C IN-CIRCUIT SIMULATOR
OPERATOR'S MANUAL**

Important Notice to Users

While every effort has been made to ensure the accuracy of all information in this document, Motorola assumes no liability to any party for any loss or damage caused by errors or omissions or by statements of any kind in this document, its updates, supplements, or special editions, whether such errors are omissions or statements resulting from negligence, accident, or any other cause. Motorola further assumes no liability arising out of the application or use of any information, product, or system described herein; nor any liability for incidental or consequential damages arising from the use of this document. Motorola disclaims all warranties regarding the information contained herein, whether expressed, implied, or statutory, *including implied warranties of merchantability or fitness for a particular purpose*. Motorola makes no representation that the interconnection of products in the manner described herein will not infringe on existing or future patent rights, nor do the descriptions contained herein imply the granting or license to make, use or sell equipment constructed in accordance with this description.

Trademarks

This document includes these trademarks:

Motorola and the Motorola logo are registered trademarks of Motorola Inc.

IBM is a registered trademark of IBM Corporation.

Windows is a registered trademark of Microsoft Corporation.

CASM05W, ICS05CW, and WinIDE software are © P & E Microcomputer Systems, Inc, 1996; all rights reserved.

Motorola Inc. is an Equal Opportunity /Affirmative Action Employer.

TABLE OF CONTENTS

CHAPTER 1 INTRODUCTION

1.1 OVERVIEW.....	1-1
1.2 TOOLKIT COMPONENTS.....	1-1
1.3 HARDWARE AND SOFTWARE REQUIREMENTS.....	1-2
1.4 TOOLKIT FEATURES.....	1-2
1.5 SPECIFICATIONS	1-3
1.6 ABOUT THIS USER'S MANUAL.....	1-3
1.7 QUICK START INSTRUCTIONS.....	1-4

CHAPTER 2 POD INSTALLATION

2.1 OVERVIEW.....	2-1
2.2 INSTALLING THE M68ICS05C POD.....	2-1

CHAPTER 3 SOFTWARE INSTALLATION AND INITIALIZATION

3.1 OVERVIEW.....	3-1
3.2 THE ICS05CW SOFTWARE COMPONENTS.....	3-1
3.2.1 The WinIDE Editor	3-1
3.2.2 CASM05W.....	3-1
3.2.3 ICS05CW	3-2
3.3 INSTALLING THE ICS05CW SOFTWARE.....	3-2
3.3.1 Installation Steps	3-2
3.3.2 Starting the ICS05CW Software	3-3
3.3.3 ICS Communication.....	3-3

CHAPTER 4 THE WinIDE USER INTERFACE

4.1 OVERVIEW.....	4-1
4.2 THE WINDOWS INTEGRATED DEVELOPMENT ENVIRONMENT.....	4-1
4.3 WinIDE MAIN WINDOW	4-2
4.3.1 Main Window Functions.....	4-2
4.3.2 Main Window Components	4-2

CHAPTER 4 THE WinIDE USER INTERFACE (continued)

4.4 GETTING STARTED.....	4-3
4.4.1 Prerequisites for Starting the WinIDE Editor.....	4-3
4.4.2 Starting the WinIDE Editor.....	4-4
4.4.3 Opening Source Files	4-4
4.4.4 Navigating in the WinIDE Editor.....	4-4
4.4.5 Using Markers	4-5
4.5 COMMAND-LINE PARAMETERS.....	4-6
4.6 WinIDE TOOLBAR.....	4-7
4.7 WinIDE MENUS	4-9
4.8 WinIDE FILE OPTIONS	4-11
4.8.1 New File	4-11
4.8.2 Open File	4-12
4.8.3 Save File.....	4-12
4.8.4 Save File As.....	4-12
4.8.5 Close File.....	4-13
4.8.6 Print File.....	4-13
4.8.7 Print Setup	4-14
4.8.8 Exit	4-14
4.9 WinIDE EDIT OPTIONS.....	4-14
4.9.1 Undo	4-14
4.9.2 Redo	4-15
4.9.3 Cut	4-15
4.9.4 Copy	4-15
4.9.5 Paste	4-16
4.9.6 Delete.....	4-16
4.9.7 Select All	4-16
4.10 WinIDE ENVIRONMENT OPTIONS	4-16
4.10.1 Open Project.....	4-17
4.10.2 Save Project.....	4-18
4.10.3 Save Project As	4-18
4.10.4 Close/New Project.....	4-18
4.10.5 Setup Environment.....	4-18
4.10.5.1 The General Environment Tab	4-19
4.10.5.2 General Editor Tab	4-20
4.10.5.3 Assembler/Compiler Tab	4-22
4.10.5.4 Executable 1 (Debugger) and Executable 2 (Programmer) Tab.....	4-26

CHAPTER 4 THE WinIDE USER INTERFACE (continued)

4.10.6 Setup Fonts	4-28
4.11 WinIDE SEARCH OPTIONS.....	4-29
4.11.1 Find.....	4-29
4.11.2 Replace	4-30
4.11.3 Find Next.....	4-31
4.11.4 Go to Line.....	4-31
4.12 WinIDE WINDOW OPTIONS.....	4-31
4.12.1 Cascade.....	4-32
4.12.2 Tile	4-33
4.12.3 Arrange Icons	4-34
4.12.4 Minimize All	4-35
4.12.5 Split	4-36

CHAPTER 5 ASSEMBLER INTERFACE

5.1 OVERVIEW.....	5-1
5.2 CASM05WASSEMBLER USER INTERFACE.....	5-2
5.2.1 Passing Command Line Parameters to the Assembler in Windows 3.x	5-3
5.2.2 Passing Command Line Parameters to the Assembler in Windows 95.....	5-4
5.3 ASSEMBLER PARAMETERS.....	5-4
5.4 ASSEMBLER OUTPUTS	5-5
5.4.1 Object Files.....	5-5
5.4.2 Map Files.....	5-6
5.4.3 Listing Files.....	5-6
5.4.4 Files from Other Assemblers.....	5-6
5.5 ASSEMBLER OPTIONS.....	5-7
5.5.1 Operands and Constants	5-7
5.5.2 Comments.....	5-8
5.6 ASSEMBLER DIRECTIVES	5-8
5.6.1 BASE.....	5-8
5.6.2 Cycle Adder.....	5-9
5.6.3 Conditional Assembly	5-11
5.6.4 INCLUDE.....	5-11
5.6.5 MACRO	5-12

CHAPTER 5 ASSEMBLER INTERFACE (continued)

5.7 LISTING DIRECTIVES	5-13
5.7.1 Listing Files	5-13
5.7.2 Labels	5-15
5.8 PSEUDO OPERATIONS.....	5-16
5.8.1 Equate (EQU).....	5-16
5.8.2 Form Constant Byte (FCB)	5-17
5.8.3 Form Double Byte (FDB).....	5-17
5.8.4 Originate (ORG).....	5-17
5.8.5 Reserve Memory Byte (RMB).....	5-17
5.9 ASSEMBLER ERROR MESSAGES	5-18
5.10 USING FILES FROM OTHER ASSEMBLERS.....	5-20

CHAPTER 6 ICS05CW SIMULATOR USER INTERFACE

6.1 OVERVIEW.....	6-1
6.2 THE ICS05CW IN-CIRCUIT SIMULATOR.....	6-1
6.2.1 ICS05CW Simulation Speed.....	6-1
6.2.2 System Requirements for Running the ICS05CW.....	6-2
6.2.3 File Types and Formats	6-2
6.3 STARTING ICS05CW.....	6-5
6.4 ICS05CW WINDOWS.....	6-7
6.5 CODE WINDOWS	6-7
6.5.1 To Display the Code Windows Shortcut Menus.....	6-8
6.5.2 Code Window Shortcut Menu Functions	6-8
6.5.3 Code Window Keyboard Commands.....	6-9
6.6 VARIABLES WINDOW	6-9
6.6.1 Displaying the Variables Shortcut Menu	6-10
6.6.2 Variables Window Shortcut Menu Options	6-10
6.6.3 Variable Window Keyboard Commands.....	6-11
6.7 MEMORY WINDOW	6-12
6.8 STATUS WINDOW	6-13
6.9 CPU WINDOW.....	6-15
6.9.1 Changing Register Values.....	6-15
6.9.2 CPU Window Keyboard Commands	6-16

CHAPTER 6 ICS05CW SIMULATOR USER INTERFACE (continued)

6.10 CHIP WINDOW	6-17
6.10.1 Reading Values in the Chip Window	6-17
6.10.2 Chip Window Keyboard Commands	6-17
6.11 CYCLES WINDOW	6-18
6.12 STACK WINDOW	6-18
6.12.1 Interrupt Stack	6-19
6.12.2 Subroutine Stack	6-19
6.13 TRACE WINDOW	6-20
6.14 BREAKPOINT WINDOW	6-21
6.14.1 Adding a Breakpoint	6-21
6.14.2 Editing a Breakpoint.....	6-22
6.14.3 Deleting a Breakpoint.....	6-22
6.14.4 Removing All Breakpoints.....	6-23
6.15 PROGRAMMER WINDOWS.....	6-23
6.16 REGISTER BLOCK WINDOW.....	6-24
6.17 ENTERING DEBUGGING COMMANDS.....	6-25
6.18 ICS05CW TOOLBAR.....	6-25
6.19 ICS05CW MENUS	6-27
6.20 FILE OPTIONS.....	6-28
6.20.1 Load S19 File	6-29
6.20.2 Reload Last S19.....	6-29
6.20.3 Play Macro.....	6-30
6.20.4 Record Macro.....	6-30
6.20.5 Stop Macro	6-31
6.20.6 Open Logfile.....	6-31
6.20.7 Close Logfile	6-32
6.20.8 Exit	6-32
6.21 ICS05CW EXECUTE OPTIONS	6-33
6.21.1 Reset Processor.....	6-33
6.21.2 Step.....	6-33
6.21.3 Multiple Step	6-34
6.21.4 Go.....	6-34
6.21.5 Stop.....	6-34
6.21.6 Repeat Command.....	6-34

CHAPTER 6 ICS05CW SIMULATOR USER INTERFACE (continued)

6.22 ICS05CW WINDOW OPTIONS	6-35
6.22.1 Open Windows	6-35
6.22.2 Change Colors	6-35
6.22.3 Reload Desktop	6-36
6.22.4 Save Desktop	6-36

CHAPTER 7 ICS05CW DEBUGGING COMMAND SET

7.1 OVERVIEW	7-1
7.2 ICS05CW COMMAND SYNTAX	7-2
7.3 COMMAND-SET SUMMARY	7-3
7.3.1 Argument Types	7-3
7.3.2 Command Summary	7-4
7.4 COMMAND DESCRIPTIONS	7-9

CHAPTER 8 EXAMPLE PROJECT

8.1 OVERVIEW	8-1
8.2 SETTING UP A SAMPLE PROJECT	8-1
8.2.1 Set Up the Environment	8-1
8.2.2 Create the Source Files	8-2
8.2.3 Assemble the Project	8-3

APPENDIX A S-RECORD INFORMATION

A.1 OVERVIEW	A-1
A.2 S-RECORD CONTENT	A-1
A.3 S-RECORD TYPES	A-2
A.4 S-RECORD CREATION	A-3
A.5 S-RECORD EXAMPLE	A-3
A.5.1 The S0 Header Record	A-4
A.5.2 The First S1 Record	A-5
A.5.3 The S9 Termination Record	A-6
A.5.4 ASCII Characters	A-6

APPENDIX B SUPPORT INFORMATION

B.1 OVERVIEW	B-1
B.2 FUNCTIONAL DESCRIPTION OF THE KIT.....	B-1
B.2.1 The Emulator	B-1
B.2.2 Programming	B-2
B.3 TROUBLESHOOTING THE QUICK START.....	B-2
B.4 TROUBLESHOOTING THE PROGRAMMER	B-4
B.5 SCHEMATIC DIAGRAM AND PARTS LIST.....	B-5
B.6 BOARD LAYOUT.....	B-10

GLOSSARY**INDEX****FIGURES**

1-1. <i>WinIDE Environment Settings</i> Dialog <i>EXE1 Tab</i>	1-5
1-2. <i>WinIDE Environment Settings</i> Dialog <i>Assembler/Compiler Tab</i>	1-5
1-3. The WinIDE Debugger Toolbar Button.....	1-6
1-4. The WinIDE Assemble/Compile File Toolbar Button.....	1-6
3-1. The <i>Pick Device</i> Dialog	3-4
4-1. WinIDE Window Components	4-2
4-2. WinIDE Status Bar.....	4-3
4-3. Edit Shortcut Menu	4-5
4-4. Marker Sub-menu	4-6
4-5. WinIDE Toolbar	4-7
4-6. File Menu	4-11
4-7. <i>Open File</i> Dialog.....	4-12
4-8. <i>Print</i> Dialog.....	4-13
4-9. Edit Menu.....	4-14
4-10. Environment Menu	4-17
4-11. <i>Specify project file to open</i> Dialog	4-17
4-12. <i>Specify project file to save</i> Dialog.....	4-18
4-13. <i>Environment Settings</i> Dialog <i>General Environment Tab</i>	4-19
4-14. <i>Environment Settings</i> Dialog: <i>General Editor Tab</i>	4-21

FIGURES (continued)

4-15. <i>Environment Settings</i> Dialog: <i>Assembler/Compiler</i> Tab	4-23
4-16. Error Format List.....	4-26
4-17. <i>Environment Settings</i> Dialog: <i>EXE 1 (Debugger)</i> and <i>EXE 2 (Programmer)</i> Tabs	4-27
4-18. <i>Setup Fonts</i> Dialog.....	4-28
4-19. Search Menu	4-29
4-20. <i>Find</i> Dialog	4-29
4-21. <i>Replace</i> Dialog.....	4-30
4-22. <i>Go To Line Number</i> Dialog.....	4-31
4-23. The Window Menu	4-32
4-24. WinIDE with Subordinate Windows Cascaded.....	4-32
4-25. WinIDE with Subordinate Windows Tiled.....	4-33
4-26. WinIDE with One Source Window Displayed and Remaining Windows Minimized	4-34
4-27. The WinIDE Editor with Subordinate Windows Minimized.....	4-35
4-28. Cascaded Windows with Active Window Split.....	4-36
5-1. WinIDE with CASM05W Assembler Window Displayed.....	5-2
5-2. Windows 95 Program Item Property Sheet (Shortcut Property for CASM05W.EXE).....	5-3
5-3. CASM05W for Windows Assembler Parameters.....	5-4
6-1. <i>Can't Contact Board</i> Dialog	6-6
6-2. The ICS05CW Windows Default Positions.....	6-7
6-3. Code Window in Disassembly Mode with Breakpoint Toggled.....	6-8
6-4. Code Window Shortcut Menu	6-8
6-5. <i>Window Base Address</i> Dialog	6-9
6-6. Variables Window with Shortcut Menu.....	6-10
6-7. <i>Add Variable</i> Dialog	6-10
6-8. Memory Window with Shortcut Menu	6-12
6-9. Status Window	6-13
6-10. Results of Entering the LF Command in the Status Window	6-14
6-11. <i>Specify Output LOG File!</i> Dialog	6-14
6-12. The <i>Logfile Already Exists</i> Message.....	6-14
6-13. CPU Window with Shortcut Menu	6-15
6-14. The <i>Change CCR</i> Dialog	6-16
6-15. Chip Window	6-17
6-16. Cycles Window	6-18
6-17. Stack Window	6-19
6-18. Trace Window.....	6-20
6-19. Breakpoint Window with Shortcut Menu	6-21
6-20. <i>Edit Breakpoint</i> Dialog	6-21

FIGURES (continued)

6-21. PROG05C Programmer Pick Window	6-23
6-22. Programmer Files Window	6-24
6-23. The Register Block Window.....	6-24
6-24. The WinReg Window with Typical Register File Information.....	6-25
6-25. WinIDE Toolbar	6-25
6-26. File Menu	6-28
6-27. <i>Specify S19 File to Load</i> Dialog	6-29
6-28. <i>Specify MACRO File to Execute</i> Dialog	6-30
6-29. <i>Specify MACRO File to Record</i> Dialog	6-30
6-30. <i>Specify Output LOG File</i> Dialog.....	6-31
6-31. <i>Logfile Already Exists</i> Dialog	6-31
6-32. A Sample Output Log File.....	6-32
6-33. ICS05CW Execute Menu.....	6-33
6-34. Window Menu	6-35
6-35. <i>Change Window Colors</i> Dialog	6-36
7-1. Assembly Window — ASM Command with (left), without (right) Argument.....	7-11
7-2. <i>Pick Device</i> Dialog.....	7-26
7-3. <i>Modify Memory</i> Dialog	7-59
7-4. PROG05P Programmer Pick Window.....	7-67
8-1. CASM05W Window.....	8-4
B-1. M68ICS05C Schematic Diagram (Sheet 1 of 2).....	B-6
B-2. M68ICS05C Schematic Diagram (Sheet 2 of 2).....	B-7
B-3. M68ICS05C Board Layout.....	B-11

TABLES

1-1. M68ICS05C Specifications.....	1-3
3-1. The ICS05CW Software Files.....	3-3
4-1. WinIDE Toolbar Buttons	4-8
4-2. WinIDE Menus and Options Summary	4-9
4-2. WinIDE Menus and Options Summary (continued).....	4-10
5-1. Change Base Prefixes/Suffixes	5-8
5-2. Assembler Directives	5-10
5-3. Listing Directives.....	5-13
5-4. Listing File Fields	5-14
5-5. Pseudo Operations Allowed by the CASM05W.....	5-16
5-6. Assembler Error Messages.....	5-18

TABLES (continued)

5-6. Assembler Error Messages (continued).....	5-19
6-1. Base Prefixes and Suffixes.....	6-11
6-2. ICS05CW Toolbar Buttons.....	6-26
6-3. ICS05CW Menus and Options Summary	6-27
6-3. ICS05CW Menus and Options Summary (continued).....	6-28
7-1. Argument Types.....	7-3
7-2. ICS05CW Command Overview.....	7-4
7-2. ICS05CW Command Overview (continued).....	7-5
7-2. ICS05CW Command Overview (continued).....	7-6
7-2. ICS05CW Command Overview (continued).....	7-7
7-2. ICS05CW Command Overview (continued).....	7-8
7-2. ICS05CW Command Overview (continued).....	7-9
7-3. PROGRAM Commands.....	7-68
A-1. S-Record Fields.....	A-1
A-2. S-Record Field Contents	A-2
A-3. S-Record Types.....	A-3
A-4. S0 Header Record	A-4
A-5. S1 Header Record	A-5
A-6. S-9 Header Record.....	A-6
B-1. M68ICS05C Parts List	B-8
B-1. M68ICS05C Parts List (continued).....	B-9
B-1. M68ICS05C Parts List (continued).....	B-10

CHAPTER 1

INTRODUCTION

1.1 OVERVIEW

This chapter provides an overview of the M68ICS05C In-Circuit Simulator Kit components and a Quick Start guide to setting up a development project.

The Motorola M68ICS05C In-Circuit Simulator Kit is a development toolkit for designers who develop and debug target systems that incorporate M68HC705 C4, C8, and C9 (A) Microcontroller Units (MCU) devices. The toolkit contains all of the hardware and software needed to develop and simulate source code for and program the Motorola M68HC705C microcontrollers.

Together, the M68ICS05C printed circuit board (pod) and the ICS05CW software form a complete simulator and non-real-time I/O emulator for the M68HC705 C4, C8, and C9 (A) devices. When you connect the pod to your PC and your target hardware, you can use the actual inputs and outputs of the target system during simulation of code.

Use the M68ICS05C toolkit with any IBM-Windows 3.x or Windows 95-based computer with a serial port.

1.2 TOOLKIT COMPONENTS

The complete M68ICS05C toolkit contains:

- Hardware:
 - The M68ICS05C in-circuit simulator pod.
 - Sample M68HC705C8A and M68HC705C9A EEPROM MCUs.
 - A 40-pin DIP target emulation cable.
- Windows-optimized software components, collectively referred to as ICS05CW software, and consisting of:
 - WINIDE.EXE, the integrated development environment (IDE) software interface to your target system for editing and performing software or in-circuit simulation.
 - CASM05W.EXE, the CASM05W command-line cross-assembler.

- ICS05CW.EXE, the in-circuit/standalone simulator software for the M68ICS05C target MCU.
- Documentation:
 - The *M68ICS05C In-Circuit Simulator Operator's Manual*.
 - Technical literature, including *Understanding Small Microcontrollers*, an introductory guide to understanding and using Motorola MC68HC05 family microcontrollers.

1.3 HARDWARE AND SOFTWARE REQUIREMENTS

The ICS05CW software requires this minimum hardware and software configuration:

- An IBM-compatible host computer running Windows 3.x or Windows 95 operating system.
- Approximately 640 Kb of memory (RAM) and 2 Mb free drive space.
- A serial port for communications between the M68ICS05C and the host computer.

1.4 TOOLKIT FEATURES

The M68ICS05C toolkit is a low-cost development system that supports in-circuit simulation. Its features include:

- Software and in-circuit simulation of M68HC705 C4, C8, and C9 (A) MCUs
- Ability to program M68HC705 C4, C8, and C9 (A) EPROM microcontrollers
- Communication with the host PC via a serial port
- ICS05CW software, including editor, assembler, and assembly source-level simulator
- 64 instruction breakpoints
- SCRIPT command for automatic execution of a sequence of commands
- Emulation cable for connection to the target system
- On-screen, context-sensitive Windows Help
- CHIPINFO command supplies M68ICS05C pod memory-map, vector, register, and pin-out information
- Software responds to both mouse and keyboard controls

1.5 SPECIFICATIONS

Table 1-1 summarizes the M68ICS05C hardware specifications.

Table 1-1. M68ICS05C Specifications

Characteristic	Specification
Temperature: Operating Storage	0° to 40° C -40° to +85° C
Relative humidity	0 to 95% (non-condensing)
Power requirement	+9 Vdc @ 0.1 A (maximum) (from included wall transformer)
Dimensions	3.5 x 3.2 in. (89 x 81 mm)

1.6 ABOUT THIS USER'S MANUAL

This manual covers the M68ICS05C software, hardware, and reference information as follows:

- Chapter 2** — Pod Installation
- Chapter 3** — Loading and Initializing the ICS05CW Software
- Chapter 4** — WinIDE User Interface
- Chapter 5** — ICS05CW In-Circuit Simulator User Interface
- Chapter 6** — CASM05W Assembler Interface
- Chapter 7** — ICS05CW Debugging Command Set
- Chapter 8** — Example Project
- Appendix A** — S-Record Information
- Appendix B** — M68ICS05C Support Information
- Glossary**
- Index**

NOTE

The procedural instructions in this user's manual assume that you are familiar with the Windows interface and selection procedures.

Figures in this manual show ICS05CW windows and dialog boxes as they appear in the Windows 95 environment.

1.7 QUICK START INSTRUCTIONS

The following instructions summarize the hardware and software installation instructions of Chapters 2 and 3.

If you are experienced in installing Motorola or other development tools, follow these steps.

- **Install the ICS05CW software:** follow the instructions on the diskette label to run the ICS05CW Setup program. During installation, follow the instructions in the installation wizard: choose the *Typical Install* option to install the files to your hard disk, or choose the *Compact Install* option to copy the files onto another diskette.
- **Connect the M68ICS05C pod:** connect the M68ICS05C pod to the host PC's serial port using the included cable. Plug the cable into the pod connector P2.
- **Supply power to the M68ICS05C pod:** connect the wall-mounted transformer's circular connector to the connector on the left side of the pod, next to the serial connector.
- **Start the WinIDE editor and open the project files:** Double click the WinIDE icon. From the WinIDE Environment menu, choose the *Open Project* option, and choose a project file from the *Specify project file to open* dialog. If no project file exists, choose the *New* option from the File menu to create a new project file. Paragraph 8.3 gives additional information about setting up a sample project.
- **Configure the environment for the ICS05CW software components:** from the WinIDE Environment menu, select the *Setup Environment* option to open the *Environment Settings* dialog and make the following changes:
 - Click on the *EXE1 Debugger* tab to bring the tab (Figure 1-1) to the front. Set the executable type, path and filename, command line options (including optional switches, filenames, or port settings), and other options for the ICS05CW debugger application.

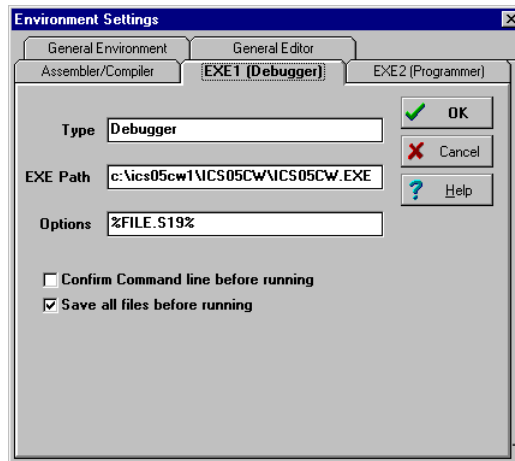

Figure 1-1. WinIDE Environment Settings Dialog EXE1 Tab

- Click on the *Assembler/Compiler* tab label to bring the tab (Figure 1-2) to the front. Set the executable path and filename, type, and other options for the CASM05W assembler or other application.

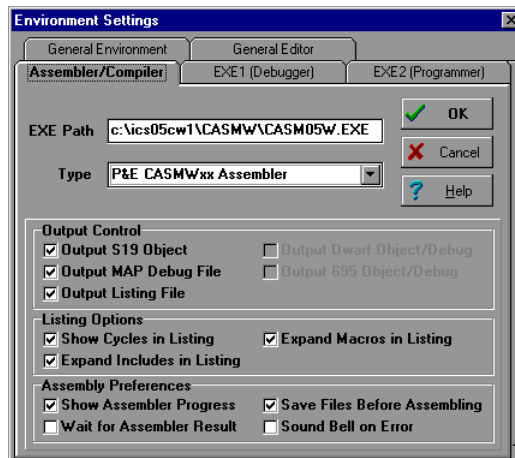

Figure 1-2. WinIDE Environment Settings Dialog Assembler/Compiler Tab

- If necessary, change the programmer settings in the *EXE2 (Programmer)* tab.
- Click on the *General Environment* and *General Editor* tabs and make changes in each as necessary.
- When you have specified all the environment settings, press the OK button to save the changes in the *WINIDE.INI* file and close the *Environment Settings* dialog.
- **Create a project file:** The desktop and environment settings you make in the *Environment Settings* dialog are stored in the *WINIDE.INI* file and read each time you start the WinIDE editor. You may also choose to save project-specific desktop and

environment settings in a project file (*.PPF) which is read when you open the project, allowing you to save and use a general environment as well as custom environments for individual projects. To create the project file:

- Specify the project-specific desktop and environment settings in the WinIDE editor.
- Choose the *Save Project As* option from the WinIDE Environment menu to name and save the project to a directory folder.
- **Run the ICS05CW simulator:** With a project or source file open in the WinIDE main window, click the Debugger (EXE1) button (Figure 1-3) on the WinIDE toolbar to start the ICS05CW debugger and debug the contents of the active source window. Additional information about the ICS05CW debugger can be found in Chapter 6 and Chapter 7.



Figure 1-3. The WinIDE Debugger Toolbar Button

- **Assemble the code:** Press the *Assemble/Compile File* button (Figure 1-4) on the WinIDE toolbar to assemble the source code in the active WinIDE window. Additional information about the CASM05W assembler can be found in Chapter 5.



Figure 1-4. The WinIDE Assemble/Compile File Toolbar Button

If you experience problems with the Quick Start procedures, refer to section B.3 for troubleshooting instructions.

CHAPTER 2

POD INSTALLATION

2.1 OVERVIEW

This chapter explains how to install the hardware components of the M68ICS05C in-circuit simulator on your host PC in both interactive and standalone modes.

When the M68ICS05C pod is connected to the serial port of a host PC, you can use the actual inputs and outputs of your target system during simulation of your source code. When the pod is not connected to the PC, you can use the ICS05CW software as a standalone simulator.

2.2 INSTALLING THE M68ICS05C POD

Before beginning, locate these pod components:

- Hardware reset switch S3
- Power On switch S1
- 9-pin RS-232 serial connector P2
- 9 Volt Input Circular connector P1

To install the M68ICS05C Pod:

1. Connect the M68ICS05C pod to the serial port of your computer: attach the supplied 9-pin serial cable to the connector on the M68ICS05C board and attach the other end to the host PC's serial port.
2. Connect the 9-volt power supply: attach the power supply plug to the circular power connector on the M68ICS05C pod and plug the power supply into a surge protection device or wall outlet.
3. To run the ICS05CW software with actual input and output from the target device, connect the M68ICS05C pod to the 40-pin DIP socket on the target board using the 40-pin ribbon cable included in the M68ICS05C kit. When this connection is established and the pod and target system are started up, the target system will provide inputs to and accept output from the ICS05CW software.

CHAPTER 3

SOFTWARE INSTALLATION AND INITIALIZATION

3.1 OVERVIEW

This chapter how to install and initialize the ICS05CW software.

3.2 THE ICS05CW SOFTWARE COMPONENTS

The ICS05CW software consists of the following components:

- WINIDE.EXE: the Windows Integrated Development Environment editor
- CASM05W.EXE: the 68HC05 Cross Assembler
- ICS05CW.EXE: the in-circuit Simulator, optimized for the HC05Cx-family Motorola microcontrollers

3.2.1 The WinIDE Editor

The WinIDE editor is a text editing application that lets you use several different programs from within a single development environment. Use the WinIDE editor to edit source code, launch a variety of compatible assemblers, compilers, debuggers, or programmers, and configure the environment to read and display errors from such programs.

If you select error detection options in the *Environment Settings* dialog, the WinIDE editor will highlight errors in the source code, and display the error messages from the compiler or assembler in the editor.

To debug source code in the WinIDE code window, load compatible source-level map files. You can configure the CASM05W to produce such map files as an output.

Because the WinIDE editor is modular, you may, for example, choose to substitute a third party C-compiler or other assembler for the CASM05W cross assembler provided in the toolkit.

3.2.2 CASM05W

The CASM05W is a cross assembler that creates Motorola S19 object files and MAP files from assembly files containing 68HC05 instructions.

The CASM05W assembler has the same functionality as the DOS version of the assembler, optimized to take advantage of the Windows graphical environment. Using the assembler in conjunction with the WinIDE editor, you can edit standard ASCII files (such as the .ASM assembly files), and use menu options and toolbar buttons to call other customized assemblers, compilers, or debuggers. The resulting environment can allow assembled files to be downloaded and tested while the original source code is modified and assembled, all without leaving the WinIDE editing environment.

Paragraph 5-5 gives additional information about assembler options and how to use them.

3.2.3 ICS05CW

The ICS05CW is a simulator for HC705C series microcontrollers that can get inputs and outputs (I/O) for the device when the external M68ICS05C pod is attached to the host computer. If you want to use I/O from your own target board, you can attach the M68ICS05C pod to your board through the extension cable that comes with the toolkit. You can also program HC05C devices using the ICS05C board and ICS05CW software.

You can start or move to the ICS05CW in-circuit simulator software from the WinIDE editor. The ICS05CW software can also be started using standard Windows techniques and run independently of the WinIDE editor.

The ICS05CW simulator accepts standard Motorola S19 object code files as input for object code simulation and debugging. If you are using a third party assembly- or C-language compiler, the compiler must be capable of producing source-level map files to allow source-level debugging.

3.3 INSTALLING THE ICS05CW SOFTWARE

The ICS05CW software is supplied on two 3.5" diskettes containing a setup program that automatically installs the software on your hard drive.

3.3.1 Installation Steps

To install the software on your host computer's hard drive, follow these steps:

1. Insert the ICS05CW diskette into the 3.5-inch disk drive.
For Windows 3.x: in the Program Manager, select Run from the File menu.
For Windows 95: from the Start Menu, select the Run option.
2. In the Run dialog, enter Setup (or click the Browse button to select a different drive and/or directory) and press OK.

3. In the ICS05CW Microsoft Setup Wizard, follow the instructions that appear on the screen.

NOTE

Select either the Typical Installation type to install the files to your hard disk, or choose Compact Installation to copy the files to another diskette.

Table 3-1 lists the files and directories required to control the ICS05CW program modules.

Table 3-1. The ICS05CW Software Files

Directory	Filename	Description
Casmw	casm05w.exe	Windows Cross Assembler for the 68HC05
ics05cw	ics05cw.exe	Windows In-Circuit Simulator
WinIDE	winide.exe	Windows integrated Development Environment (WinIDE) program file
	Winide.hlp	Help for WinIDE

3.3.2 Starting the ICS05CW Software

Depending on the operating system you are using, choose the appropriate method for starting the WinIDE software:

- From the Windows 3.x Program Manager, double-click the WinIDE and/or ICS05CW icon(s).
- From the Windows 95 Start Menu, select the WinIDE and/or ICS05CW icon(s).

You can start the ICS05CW simulator alone or from within the WinIDE.

3.3.3 ICS Communication

When you double-click the ICS05CW icon, the software attempts to communicate with the pod using the specified COM port, baud rate, and default parameters. When the software connects to the pod, the Status Bar contains the message, "Contact with pod established."

If the pod is not installed, or the ICS05CW software cannot establish communications with the pod through the specified COM port, the *Can't Contact Board* dialog appears, with options for changing the COM port or baud rate and retrying the connection, or choosing to run the simulator in standalone mode (with no input or output from the pod).

NOTE

The COM port assignment defaults to COM 1 unless you specify another port in the startup command.

The first time you attempt to connect to the pod after installing the ICS05CW software, the software asks you to select chip from the *Pick Device* dialog (Figure 3-1):

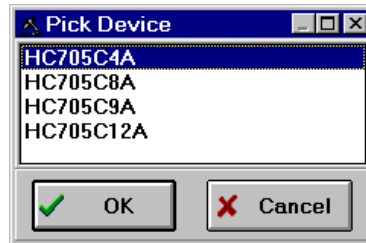

Figure 3-1. The *Pick Device* Dialog

To open the *Pick Device* dialog, enter the CHIPMODE command in the ICS05CW Status Window command line.

CHAPTER 4

THE WinIDE USER INTERFACE

4.1 OVERVIEW

This chapter is an overview of the WinIDE windows, menus, toolbars, dialogs, options, and procedures for using each.

4.2 THE WINDOWS INTEGRATED DEVELOPMENT ENVIRONMENT

The Windows Integrated Development Environment (the WinIDE editor) is a graphical interface for editing, compiling, assembling, and debugging source code for embedded systems using the M68ICS05C In-Circuit Simulator.

The WinIDE interface consists of standard Windows title and menu bars, a WinIDE toolbar, a main window containing any open source or project file windows, and a status bar. The WinIDE components are labeled in Figure 4-1 and described in paragraph 4.3.2.

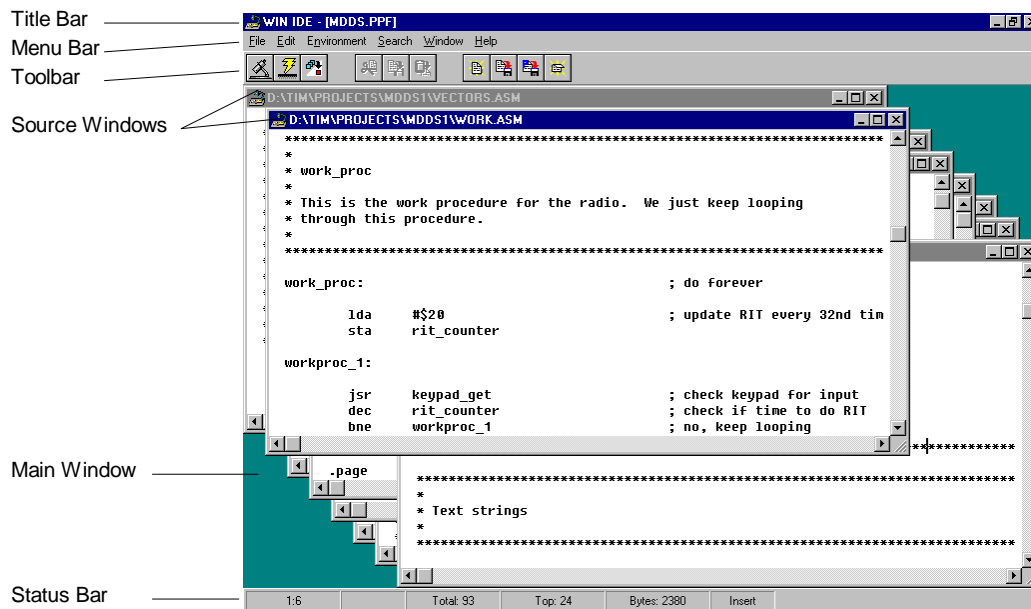

Figure 4-1. WinIDE Window Components

4.3 WinIDE MAIN WINDOW

4.3.1 Main Window Functions

When you first start the WinIDE editor, the main window opens without any source or project files. As you open or create source files or a project, they appear as subordinate windows in the main window. You can move, size, and arrange subordinate windows using standard Windows techniques and the WinIDE Window menu options.

Use the WinIDE main window to:

- Open, create, edit, save, or print source (*.ASM, *.LST, *.MAP, and *.S19) or project (*.PPF) file.
- Configure the desktop and environment settings for the editor, assembler, compiler, debugger, and other programs.
- Launch the in-circuit simulator, compiler, debugger, or another program.

4.3.2 Main Window Components

Figure 4-1 shows how the WinIDE main window might look during a typical editing project, and labels the standard window components:

- **Title Bar:** The title bar appears at the top edge of the main window and contains:

- The application title,
- The name of the target microcomputer application for which you are editing source code,
- The object file or files, if any (usually truncated),
- Windows control buttons for closing, minimizing or maximizing the window.
- **Menu Bar:** The menu bar appears immediately below the title bar and contains the names of the WinIDE menus.
- **Toolbar:** The WinIDE toolbar appears just below the menu bar and contains shortcut buttons for frequently used menu options.
- **Main Window:** The main window area is the inside portion of the main window which contains the open subordinate windows that you can resize, reposition, minimize, or maximize using standard Windows techniques or Window menu options.
- **Status Bar:** The status bar (Figure 4-2) appears along the bottom edge of the main window and contains a number of fields (depending on the project) that show:
 - Source-file line and column numbers of the blinking insertion point cursor
 - System status or progress of the current window; for example, when the window is edited, the status will be Modified
 - Total number of lines in the active window
 - Top: the current line position in the file of the top of the active window
 - Bytes: displays the total number of bytes in the active window
 - Insert/Overwrite mode: indicates the current typing mode

The status fields expand and contract as client area contents change and files become active.

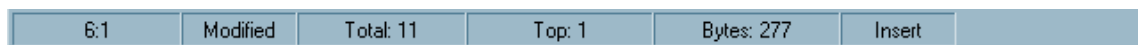

Figure 4-2. WinIDE Status Bar

4.4 GETTING STARTED

4.4.1 Prerequisites for Starting the WinIDE Editor

Before you can start the WinIDE editor, the Windows operating environment must be running and the ICS05CW software must be installed in the host computer.

Remember that for the M68ICS05C to run in simulation mode, the asynchronous communications cable must connect the M68ICS05C pod on the platform board to the host computer, and the power to the M68ICS05C pod must be on.

4.4.2 Starting the WinIDE Editor

To start the editor, select the WinIDE icon by double-clicking the ICS05CW Program Group icon in the Windows 3.1 Program Manager or by selecting the icon from the Windows 95 Start menu.

4.4.3 Opening Source Files

When the WinIDE editor opens, the main window is empty. To build the environment for your project, choose the *Open* option from the File menu (or click the File button on the WinIDE toolbar). In the *Open File* dialog, choose the files that will make up your project:

1. Select the drive containing the files from the *Drives* list.
2. Select the directory folder containing the files from the *Folders* list.
3. You may use the *Filename* text box to specify a filename or a wildcard/ extension to filter the list of filenames (or choose a file type from the *List files of type* list). The default file type is *.ASM*, but you can also choose:
 - *.*c* (source code files)
 - *.*lst* (listing files)
 - *.*txt* (text files)
 - *.* (all files)

When all of the project files have been selected, click the OK button to open the files in the WinIDE main window.

4.4.4 Navigating in the WinIDE Editor

To navigate among subordinate windows:



To navigate among the several sub-windows in which your project files are displayed in the WinIDE main window:

- Choose the subordinate window's filename from the Window menu or click on the file's title bar to bring it to the front of the cascaded stack.
- If you have a large screen or a few project files, you may choose the *Tile* option from the Window menu to lay out all of the sub-windows so that all are visible, or choose

the *Cascade* option to arrange all windows so that only the top window is entirely visible.

- Regardless of how you arrange the windows, the title bar of all windows are visible.

To move between the WinIDE editor and the ICS05CW simulator:

- From the WinIDE editor, click the *External Program 1* toolbar button  to switch to the in-circuit simulator or the application which you have specified as the debugger or other external program to use.
- From ICS05CW, click the *Back to Editor* toolbar button  to toggle back to the editor.

4.4.5 Using Markers

Markers provide a convenient way to mark multiple points in a file for navigating between frequently visited locations while you are editing. You can set as many as 10 markers in source files in the WinIDE editor. A marker appears in the file as a small button labeled with the marker number.

When you save the project, the WinIDE editor saves the markers for all open edit files as well, so that when you open the project again, the markers are still set.

To set a marker anywhere in the file:

1. Place the cursor on the line where you want the marker to be.
2. Press CNTL + SHIFT + N, where N is a value from 0 to 9 indicating the marker number. A marker appears at the far left of the line.

To move to a marker, press CNTL + N, where N is denotes a marker number between 0 and 9. This feature is useful if you are editing a large file.

Markers can also be set, changed, navigated to, or cleared using options on the Edit shortcut menu (Figure 4-3). Open the Edit shortcut menu by clicking the right mouse button in any edit window.



Figure 4-3. Edit Shortcut Menu

To set or clear a marker using the Edit shortcut menu options:

1. With the cursor in any editing window, click the right mouse button to open the shortcut menu.
2. Position the cursor on the line where the marker should appear. Click the right mouse button to display the shortcut menu.
3. Click the *Toggle Marker 0-9* option to open the list of markers.
4. Click once on the marker to toggle. When the marker number is checked, it is toggled on; when the marker number is unchecked, it is toggled off.

To move to a marker number using the shortcut menu options:

1. With the cursor anywhere in the edit file, click the right mouse button to open the Edit shortcut menu .
2. Click on the *Go To Marker 0-9* option to open the Marker sub-menu (Figure 4-4), and choose the marker number to move to.



Figure 4-4. Marker Sub-menu

You can execute many ICS05CW menu options using either keyboard commands or toolbar buttons. For example, to move to a marker, press the Ctrl + Shift + N key combination, where N is the marker number).

4.5 COMMAND-LINE PARAMETERS

The WinIDE editor lets you specify command line options to pass to each executable program. The name of the currently edited file, or some derivative thereof, can be passed within these options. To pass the current filename, specify a parameter *%FILE%*. The WinIDE editor will substitute this string with the current filename at execution time. You may also change the extension of the passed filename, by specifying it within the *%FILE%* parameter. For example, to specify an .S19 extension on the current filename the user would specify a *%FILE.S19%* parameter.

For example, if the current filename being edited is *MYPDA.ASM*:

Parameters specified	Parameters passed to program
%FILE% S L D	MYPDA.ASM S L D
%FILE.S19% 1 @2	MYPDA.S19 1 @2

Although it is by default the currently edited filename that is used in the %FILE% parameter substitution, the environment can be configured always to pass the same filename. Do this by checking the *Main File* option in the *Environment Settings* dialog's *General Options* tab. This technique is useful if you want to pass a specific filename to the external program without regard to what is being edited.

4.6 WinIDE TOOLBAR











The WinIDE Toolbar (Figure 4-5) provides a number of convenient shortcut buttons that duplicate the function of the most frequently used menu options. A tool tip or label pops up when the mouse button lingers over a toolbar button, identifying the button's function.



Figure 4-5. WinIDE Toolbar

Table 4-1 identifies and describes the WinIDE toolbar buttons.

Table 4-1. WinIDE Toolbar Buttons

Icon	Button Label	Button Function
	External Program 1 (Debugger)	Call the External Program 1 (Debugger or ICS) specified in the <i>Environment Settings</i> dialog's <i>EXE 1 (Debugger)</i> tab; this could be the debugger (by default), the ICS or other external program, i.e., third party assembler, debugger, or compiler.
	External Program 2	Call the External Program 2 as specified in the <i>Environment Settings</i> dialog's <i>EXE 2 (Programmer)</i> tab
	Assemble/Compile File	Assemble or compile the active source window .
	Cut	Cut the selected text from the active source window (this button is a shortcut for the <i>Edit - Cut</i> menu option).
	Copy	Copy the selected text in the active source window to the Windows clipboard (this button is a shortcut for the <i>Edit - Copy</i> menu option).
	Paste	Paste the contents of the Windows clipboard at the insertion-point location in the active source window (this button is a shortcut for the <i>Edit - Paste</i> menu option).
	Open File	Close the active source window (this button is a shortcut for the <i>File - Open</i> menu option).
	Save File	Save the file in the active source window (this button is a shortcut for the <i>File - Save</i> menu option).
	Save Project (All Files & Setup)	Save the active project (this button is a shortcut for the <i>Environment - Save Project As</i> menu option).
	Close File	Close the active source window (this button is a shortcut for the <i>File - Close</i> menu option).

4.7 WinIDE MENUS

Table 4-2 summarizes WinIDE menu titles and options.

Table 4-2. WinIDE Menus and Options Summary

Menu Title	Option	Description
File	New File	Open a new file window ("No name")
	Open File	Display the <i>Open File</i> dialog to choose a file to open
	Save File	Save the current file
	Save File As	Open the <i>Save As</i> dialog to choose a directory and filename in which to save the current file
	Close File	Close the current file
	Print	Open the <i>Print</i> dialog to print the current file
	Print Setup	Open the <i>Print Setup</i> dialog to choose printer options
	Exit	Close the WinIDE editor
Edit	Undo	Undo the last action
	Redo	Redo the last action
	Cut	Cut the selection to the clipboard
	Copy	Copy the selection to the clipboard
	Paste	Paste the contents of the clipboard
	Delete	Delete the selection
	Select All	Select all text in the current window

Table 4-2. WinIDE Menus and Options Summary (continued)

Menu Title	Option	Description
Environ- ment	Open Project	Open the <i>Specify Project File to Open</i> dialog
	Save Project	Save the current project
	Save Project As	Open the <i>Specify Project File to Save</i> dialog
	Close/New Project	Close the current project file or open a new project file if no current file
	Setup	Open the <i>Environment Settings</i> Dialog to change settings for: <ul style="list-style-type: none"> - General Environment - General Editor - Environment Settings - Debugger Settings
	Setup Font	Open the <i>Font</i> dialog to specify font options for the text in the current file
Search	Find	Open the <i>Find</i> dialog to enter a search string
	Replace	Open the <i>Replace</i> dialog to enter a search and replacement string
	Find Next	Go to the next occurrence of the search string
	Go to Line	Open the <i>Go to Line Number</i> dialog and enter a line number to go to in the current file
Window	Cascade	Cascade open windows with active window on top
	Tile	Tile open windows with active window on top
	Arrange Icons	Arrange minimized window icons along the bottom edge of the main window
	Minimize All	Minimize all open windows
	Split	Toggle a split window in the active file
	Windows (by name)	Itemize the open and minimized windows by name in order of opening
Help	Contents	Opens the WinIDE Help Contents Page of the Help File
	About	Displays the WinIDE About Window

4.8 WinIDE FILE OPTIONS

This section describes the WinIDE File menu options for managing and printing source files or exiting the WinIDE editor.

To select a *File* option, click once on the File menu title to open the File menu (Figure 4-6). Click on an option to perform the operation. You may also use accelerator or shortcut keystrokes to execute the option.

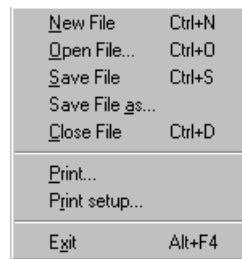

Figure 4-6. File Menu

4.8.1 New File

Choose **New File** from the File menu to open a new client window in the WinIDE main window. The title of the new window in the title bar defaults to [NONAME#], where # reflects the number of new source windows created during this session. If there is an active project, the project name appears in the title bar. If there is no project, [No Project] precedes the window name.

Use this new window to enter source code. When you save the contents of this window, the WinIDE editor prompts you for a new filename. This new filename replaces the [NONAME#] in the title bar.

Alternatives: Type **Ctrl + N** or click the New toolbar button. This is the keyboard equivalent to choosing the **File - New File** menu option.

4.8.2 Open File

Choose **Open File** from the File menu to open the *Open File* Dialog (Figure 4-7) and choose an existing filename, file type, directory, and network (if applicable) to open.

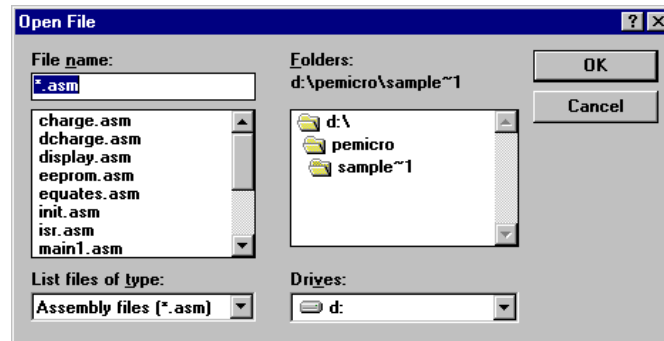

Figure 4-7. Open File Dialog

Each file opens in its own client window within the main WinIDE window.

Alternatives: Type **Ctrl + O** or click the **Open** button on the toolbar. This is the keyboard equivalent to choosing the **File - Open File** menu option.

4.8.3 Save File

Choose **Save File** from the File menu to save the file in the active source window.

- If you are saving the file for the first time (that is, it has not yet been named), the *Save As* dialog appears. Enter a new filename for the file and accept the current file type, directory or folder, and drive, or choose new options. Press the OK button to save the file to the selected drive/directory.
- If the file has been saved previously (and has a name), the file is saved with the filename, in the directory and drive previously specified, and the source window remains open.

Alternatives: Type **Ctrl + S** or click the **Save** button on the toolbar. This is the keyboard equivalent to choosing the **File - Save File** menu option.

4.8.4 Save File As

Choose **Save File As** from the **File** menu to save the contents of the active source window and assign a new filename. The *Save As* dialog opens. Enter a new file name in the *File Name* field and click the OK button to save the file and return to the source window.

To save the file with the name of an existing file, select the filename in the *File Name* list, and click the OK button. A confirmation dialog will ask you to confirm that you want to overwrite the existing file.

4.8.5 Close File

Choose **Close File** from the **File** menu to close the file in the active source window.

If you chose the *Give user option to save each file* option in the *General Environment* tab in the *Environment Settings* dialog, the *Information* dialog will display, reminding you to save changes to the .ASM file.

Alternatives: Type **Ctrl + D** or click the **Close** toolbar button. This is the keyboard equivalent to choosing the **File - Close File** menu option.

4.8.6 Print File

Choose **Print** from the **File** menu to open the *Print* dialog (Figure 4-8) and choose options for printing the active source window.

The *Print* dialog for your operating system and printer capabilities opens for you to choose Print range, Print quality, and open the *Print Setup* dialog to change printer settings.

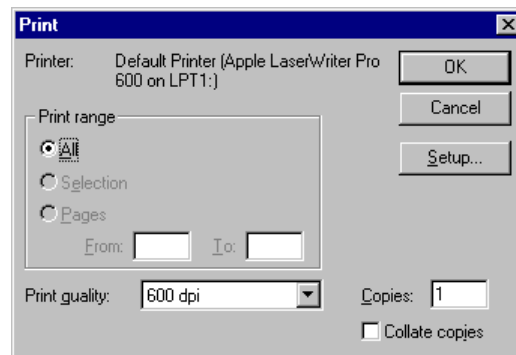

Figure 4-8. Print Dialog

NOTE

The *Print* option is active when at least one source window is open. The WinIDE editor disables the option if no window is open.

4.8.7 Print Setup

Choose the **Print Setup** option from the **File** menu to open the *Print Setup* dialog for your operating system and printer. Use this dialog to choose the printer, page orientation, paper size, and other options for your printer.

4.8.8 Exit

Choose the **Exit** option from the **File** menu to close the editor. If a project or source window is open, the editor closes the files and exits.

Alternatives: Type **Alt + F4**. This is the keyboard equivalent to choosing the **File - Exit** menu option.

4.9 WinIDE EDIT OPTIONS

This section describes the WinIDE Edit menu options for creating or editing source file contents.

To perform an Edit operation, click once on the Edit menu title to open the Edit Menu (Figure 4-9). Click on an option to perform the operation.

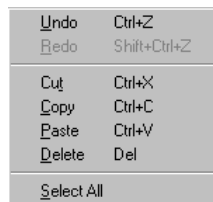

Figure 4-9. Edit Menu

4.9.1 Undo

Choose **Undo** to undo or reverse the last action or change you made in the active source window.

Changes that you make to the contents of the window (and that are undoable or reversible) are saved in an undo stack, where they accumulate, up to a maximum of 20 instances. You can reverse your changes in descending order of the sequence in which they were made. If no more changes remain in the stack, the *Undo* option is disabled.

Reversible actions are local to each source window. Commands that are not reversible do not contribute to the undo stack. You cannot, for example, undo the command to open a new window using the Undo command.

Alternatives: Type **Ctrl + Z**. This is the keyboard equivalent to selecting the **Edit - Undo** menu option.

4.9.2 Redo

Choose **Redo** to restore the most recently undone action in the active window.

The *Redo* option restores actions undone or reversed by the *Undo* option, in ascending order, that is, last action first. Reversible changes to the window's contents accumulate in the window's undo stack. Once a change has been reversed using the *Undo* option, the change can be reversed, using the *Redo* option. When no more changes remain (that is, the top of the Redo stack is reached) the *Redo* option is disabled.

Some commands are not reversible: they do not contribute to the undo stack and therefore cannot be redone. For instance, since reversible actions are local to each source window, opening a new window is an action that cannot be undone using the Undo command, or redone using the Redo command.

NOTE

The *Redo* option is active only if you have used the *Undo* option to modify the contents of the active source window.

Alternative: Type **Shift + Ctrl + Z**. This is the keyboard equivalent to selecting the **Edit - Redo** menu option.

4.9.3 Cut

Choose **Cut** from the Edit menu to cut the currently selected text from the active source window and place it on the system clipboard.

NOTE

The *Cut* option is active only when you have selected text in the active source window.

Alternative: Type **Ctrl + X**. This is the keyboard equivalent to selecting the **Edit - Cut** menu option.

4.9.4 Copy

Choose **Copy** from the Edit menu to copy the selected text from the active source window to the Windows clipboard.

NOTE

The *Copy* option is available only if you have selected text in the active source window.

Alternatives: Type **Ctrl +C** or click the Copy toolbar button. This is the keyboard equivalent to selecting the **Edit - Copy** menu option.

4.9.5 Paste

Choose **Paste** from the Edit menu to paste the contents of the Windows clipboard into the active source window at the insertion-point location.

Alternatives: Type **Ctrl + V** or click the **Paste** button on the toolbar. This is the keyboard equivalent to selecting the **Edit - Paste** menu option.

4.9.6 Delete

Choose **Delete** from the Edit menu to delete the selected text from the active source window without placing it on the Windows clipboard. Text you delete using the *Delete* option can be restored only by using the *Undo* option.

Alternatives: Press the **Delete** key. This is the keyboard equivalent to selecting the **Edit - Delete** menu option.

4.9.7 Select All

Choose **Select All** from the Edit menu to select all text in the active source window.

4.10 WinIDE ENVIRONMENT OPTIONS

This section describes the WinIDE Environment menu options for managing project information, and setting up environment and font settings for a project.

Environment settings represent the current environment and configuration information for the WinIDE editor. These settings are stored in the *WINIDE.INI* file, from which they are loaded each time you start the editor, and saved each time you exit from the editor.

When you start the editor, the application opens the *WINIDE.INI* file and reads the project information. If there is an open project, the project file's environment settings are read and used instead. This lets you have different environment configurations for different projects.

Environment information stored in the *WINIDE.INI* file includes:

- If a project is open, its name
- Current font information
- Current source directory and project directory paths

4.10.2 Save Project

Choose **Save Project** from the Environment menu to save the current project in the currently specified file and pathname.

4.10.3 Save Project As

Choose **Save Project As** from the *Environment* menu to display the *Specify project file to save* dialog (Figure 4-12).

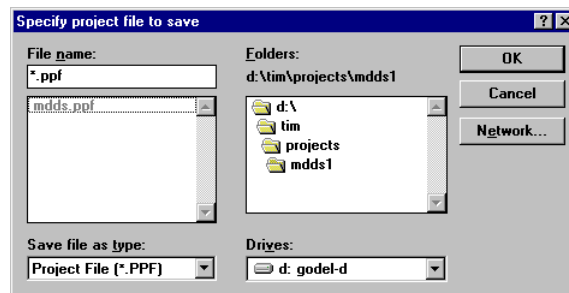

Figure 4-12. Specify project file to save Dialog

1. Enter the project name in the *File name:* text box or select the project name from the list box below.
2. Press the OK button to open the new project file (or press the Cancel button to close the dialog without opening a file).

4.10.4 Close/New Project

Choose **Close/New Project** from the Environment menu to:

- Close an active current project file
- Open a new project

4.10.5 Setup Environment

Choose **Setup Environment** from the Environment menu to display the *Environment Settings* dialog box.

The *Environment Settings* dialog contains five tabs:

- General Environment
- General Editor
- Assembler/Compiler

- EXE 1 (Debugger)
- EXE 2 (Programmer)

In the *Environment Settings* tabs, you can choose options by marking option buttons (sometimes called radio buttons), check boxes, and entering information in text boxes.

4.10.5.1 The General Environment Tab

Click the *General Environment* tab in the *Environment Settings* dialog (Figure 4-13) to change options for saving the project files, exiting the WinIDE editor, and storing a filename to be passed to an external program as a parameter.

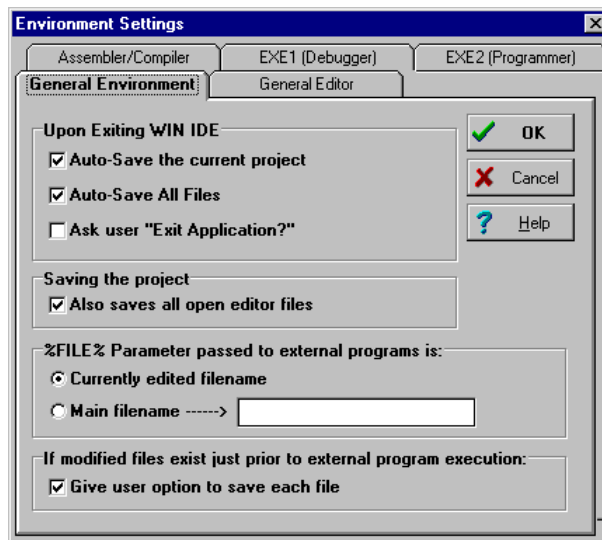

**Figure 4-13. *Environment Settings* Dialog
General Environment Tab**

NOTE

Clicking the OK button on any tab saves all changes made in the *Environment Settings* dialog and closes the dialog.

The *General Environment* Tab offers these options:

- **Upon Exiting the WinIDE Editor**
 - ***Auto-Save the Current Project:*** Select this option to save the currently open project automatically, with the file extension .PPF, without prompting. The editor saves all currently open files with the current project. If you do not select this option, the editor prompts you to save the open project when you exit. This setting only has an effect if a project is open when you exit.

-
- **Auto-Save All Files:** Select this option to save all open editor files automatically, without prompting, when you exit. If you do not select this option, the editor will prompt you to save open files when you exit.
 - **Ask user "Exit Application"** Select this option to display an *Exit Application* confirmation message when you exit. If you do not select this option, the editor will close without asking for confirmation when you choose the *Exit* option from the File menu.
 - **Saving the Project**
 - **Also save all open editor files:** Select this option to save all open editor files whenever you save the project file. If you do not select this option, project/environment information is written to the project files, but editor files are not saved when you choose the *Save Project* option from the Environment menu.
 - **%FILE% Parameter passed to executable programs is:** The *%FILE%* parameter specifies what is passed on the command line in place of the *%FILE%* string. You may specify the *%FILE%* string as a command line parameter for executable programs launched from within the WinIDE editor.
 - **Currently edited filename:** Select this option to use the name of the current active file (the window with focus) as the *%FILE%* parameter substitution.
 - **Main Filename:** Select this option to use the filename in the *Main filename* edit box as the *%FILE%* parameter substitution.

NOTE

If you are using include files, you must enter the full pathname of the file containing the included files in the *Main filename* edit box.

- **If Modified files exist just prior to external program execution:** All executable programs which you can launch from the WinIDE editor offer the option to save all open editor files before the executable is launched.
 - **Give user option to save each file:** Select this option if you want to be prompted to save each modified file before the external program is launched. If you do not select this option, the external program runs without asking for your confirmation. The result may be that an external program runs while modified files exist in the editing environment, a circumstance that may be undesirable and lead to incorrect results.

4.10.5.2 General Editor Tab

Click the *General Editor* tab in the *Environment Settings* dialog (Figure 4-14) to bring the *General Editor* tab to the front. Use the *General Editor* tab to change editing options such as indentation, word wrap, and tab settings.

NOTE:

To change font options, choose the **Setup Font** option from the Environment menu.

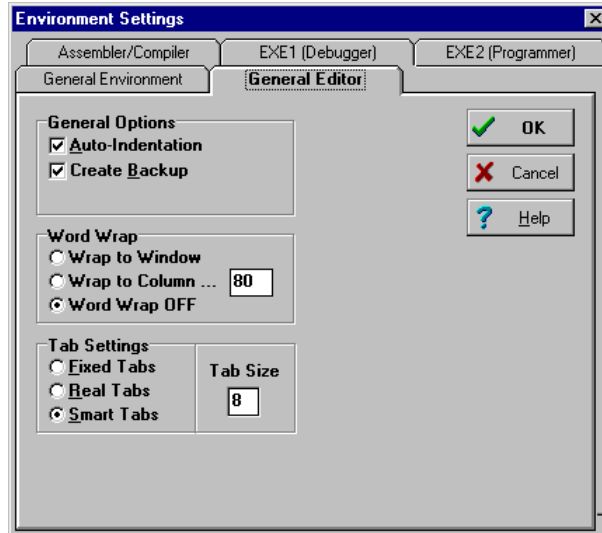

**Figure 4-14. Environment Settings Dialog:
General Editor Tab**

- **General Options**

- **Auto-Indentation:** Select this option to place the cursor in the column of the first non-space character of the previous line when the Enter key is pressed. If this option is not checked, the cursor goes to the first column. For example, if the current line begins with two tab spaces, pressing the Enter key will begin the next line with two tab spaces, aligning the new line under the first text of the previous line.
- **Create Backup:** Select this option to create a backup file whenever a file is saved. The WinIDE editor will copy the current disk version of the file (the last save) to a file of the same name with the .BAK extension, then save the current edited copy over the editing filename. The default (and recommended) setting for this option is "on," giving you the option to return or review the previous version of the file. If you do not select this option, the currently edited file will be saved, but no backup will be made.

- **Word Wrap**

- **Wrap to Window:** Select this option to have the cursor to wrap to the left when it reaches the far right side of the window. This lets you see all the text in the file, without scrolling the line. If you do not select this option, text wraps only when you press the Enter key.
- **Wrap to Column:** Select this option to wrap text to the left side when the cursor reaches a specified column. This lets you see all the text in the file,

without scrolling the line. Set the column number at which text wrapping should occur in the edit box to the right of this option.

- **Word Wrap OFF:** Select this option to turn text wrapping off. To view or edit text, which does not fit horizontally in the window, use the scroll controls. In general, this option should be on when you are writing or editing code.
- **Tab Settings**
 - **Fixed Tabs:** Select this option to use spaces to emulate tabs: pressing the tab key inserts a number of spaces to bring the cursor to the position of the next tab stop. Changing the tab size affects only future tab spacings. Past tabs remain unchanged.
 - **Real Tabs:** Select this option to use actual tab characters: pressing the tab key inserts a tab character. The tab character is displayed as a number of spaces determined by the tab size, but is really a tab character. Changing the tab size affects the display of *all* tabs in the file, present and future.
 - **Smart Tabs:** Select this option to enable smart tabs:
 - ◆ If the previous line contains text, pressing the tab key advances the cursor to the same column as the beginning of the next character group on the previous line.
 - ◆ If the previous line does not contain text, smart tabs behave as fixed tabs.
 - **Tab Size:** Enter the number of spaces in a tab. This setting affects how all tabs operate: fixed, real, or smart tabs. This number is the default display size of all tab characters, and the size in spaces of a tab in both fixed and smart modes. If the tab size is N , the tab stops are at 1, $N+1$, $2N+1$, $3N+1$, and so on.

4.10.5.3 Assembler/Compiler Tab

In addition to running an external compiler, you may need to run other external programs such as third party programmers, debuggers, or simulators. The WinIDE editor lets you configure as many as three external programs: two general-purpose programs and one compiler. Use the settings on the *Assembler/Compiler* tab of the WinIDE *Environment Settings* dialog to set up external programs.

Click the *Assembler/Compiler* tab heading in the *Environment Settings* dialog (Figure 4-15) to bring the tab to the front. Use the options on this tab to change the settings and parameters for the assembler or compiler path and type, and specify output, listing, and assembly preferences.

- **EXE Path:** Enter the full path and executable name of the compiler in the text box. The extensions *EXE/COM/BAT* are legal. For a DOS executable or BATch file, you may want to create a *PIF* file to prevent the screen from changing video modes when the executable runs.

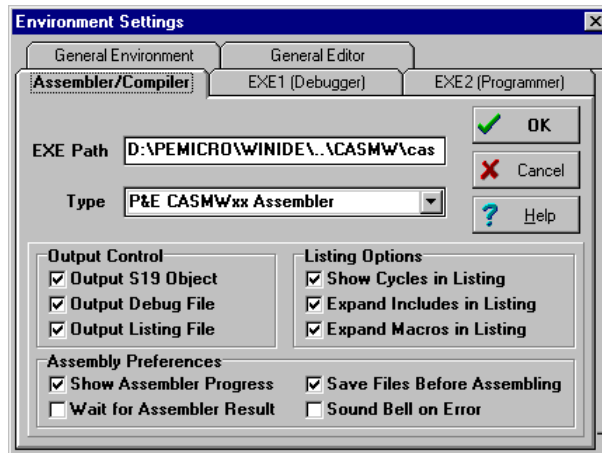

**Figure 4-15. Environment Settings Dialog:
Assembler/Compiler Tab**

- **TYPE:** Click on the downward-pointing arrow to the right of the *Type* list box to display the compiler types. Click on the compiler type to select it. The options in the *Assembler/Compiler* tab change according to the compiler type chosen:
 - If you select the P&E compiler, a number of compiler options are available.
 - If you select a non-P&E compiler, options lets you specify the parameters to pass the compiler.
- **Output Control:** These options specify the output files that the assembler will create:
 - **Output S19 Object:** Select this option to have the assembler output an S19 object file. The S19 object file contains the compiled instructions from the program assembled. The output S19 file has the same name as the assembly file, but with the .S19 extension. Appendix A: S-Record Information gives more information about the S19 file format.
 - **Output Debug File:** Select this option to have the assembler produce a debug .MAP file. The debug .MAP file contains symbol information as well as line number information for source level debugging from the program assembled. The output debug file has the same name as the assembly file, but with the .MAP extension.
 - **Output Listing File:** Select this option to have the assembler produce a listing file. The listing file shows the source code as well as the object codes that were produced from the assembler. Listing files are useful for debugging, as they let you see exactly where and how the code assembled. The output listing file has the same name as the assembly file, but with the .LST extension.

-
- **Listing Options:** The following options specify how the assembler generates the listing file.
 - **Show Cycles in Listing:** Select this option to include cycle information for each compiled instruction in the listing (.LST) file. View the cycle information to see how long each instruction takes to execute. The cycle count appears to the right of the address, enclosed in brackets.
 - **Expand Includes in Listing:** Select this option to expand all include files into the current listing file. This lets you view all source files in a main listing file. If this option is not checked, you will see only the *\$Include* statement for each included file, not the source file.
 - **Expand Macros in Listing:** Select this option to expand all macros into the listing file: each time the macro is used, the listing will show the instructions comprising the macro. If you do not select this option, you see only the macro name, not its instructions.
 - **Assembly Preferences**
 - **Show Assembler Progress:** Select this option to display a pop-up window showing the current assembly status, including:
 - ◆ The pass the assembler is currently on
 - ◆ The file that is currently being assembled
 - ◆ The line that is currently being assembled
 - If this option is not checked, you must wait for the assembly result to be displayed on the status bar at the bottom of the environment window.
 - **Wait for Assembler Result:** Select this option and the *Show Assembler Progress* option to cause a progress window displaying the assembly result to stay up when assembly is done. The assembly result window will remain until you dismiss it by clicking the OK button. In general, do not select this option, as the assembler results are shown in the status bar at the bottom of the WinIDE window.
 - **Save files before Assembling:** Select this option to save all open files to disk before you run the assembler. This is important because the assembler/compiler reads the file to be compiled from the disk, not from the open windows in the WinIDE editor. If you do not save the file before assembling it, the assembler will assemble the last saved version. In general, you should leave this option checked.
 - **Sound Bell on Error:** Select this option to have the assembler beep if it encounters an error.



- **Other Assembler/Compiler:** If you choose *Other Assembler / Compiler* from the *Type* list, the WinIDE editor offers these additional options:
 - **Options:** Enter the options to pass to the compiler on the command line. Such options generally consist of switches that instruct the compiler, and a filename. Enter the *%FILE%* string in the command line to insert either the current filename or the filename specified in the *Main Filename* option in the *EXE Path* text box of the *General Environment* tab options (Figure 4-13).
 - **Confirm command line:** Select this option to display a window describing the executable you want to run, and the parameters that you want to pass to the executable, just before the assembler/compiler is run. This gives you the option to cancel the assemble/compile, continue as described, or modify parameters before you continue with the assembly. If you do not select this option, the assembler/compiler runs without prompting you to confirm parameters.
 - **Recover Error from Compiler:** Select this option to have the WinIDE editor attempt to recover error/success information from the assembler/compiler, and open the file with the error line highlighted (and displayed in the status bar) when an error is encountered. For this feature to work, the *Error Filename* and *Error Format* options must also be set in this tab. If this option is not checked, the WinIDE editor will not look for a compiler result and will not display the results in the status bar.
 - **Wait for compiler to finish:** Select this option to have the WinIDE editor disable itself until the compiler terminates. You must select this option for the editor to attempt to recover error/success information from the assembler/compiler. Further, turning this option on prevents you from running external programs from the editor that may require compilation or assembly results. If you do not select this option, the editor starts the assembler/compiler, and continues, letting Windows' multitasking capabilities take care of the program.
 - **Save files before Assembling:** Select this option to save all open files to disk before the running the assembler. This can be very important since the assembler/compiler reads the file to be compiled from the disk and not from the memory of the WinIDE editor. If the file being assembled isn't saved, the assembler or compiler will assemble the last saved version. For this reason, you should leave this option checked.

- **Error Format:** Click the down arrow to the right of the *Error Format* list box to display the list of error formats (Figure 4-16). If the WinIDE editor is to attempt to read back an error from a compiler, it must understand the error syntax. This option lets you select an error format from a list of supported formats. If the *Recover Error from compiler* option is checked, and the filename specified in the *Error Filename* text box is found, the editor parses that file from end to beginning looking for the error. If the editor finds an error, it opens the file, highlights the error line, and displays the error in the status bar.



Figure 4-16. Error Format List

- **Error Filename:** Enter the filename to which the editor pipes the compiler/assembler error output. Some compilers provide a switch for piping error output to a file; others require that you handle this manually. As most compilers are DOS-based, you can create a batch file into which to pipe the output. For example:

```
COMPILER  OPTIONS  >  ERROR.TXT
```

This batch file creates the file *ERROR.TXT* and sends the assembler/compiler output to that file. Most C-compilers require a batch file to run the compiler through its various steps (compiling, linking), to which you may add a pipe for error output.

Once the environment reads this error file, the WinIDE editor displays the results, and the deletes the error file. If you want to keep a copy of the file, you must add such instructions to the batch file.

4.10.5.4 Executable 1 (Debugger) and Executable 2 (Programmer) Tab

Choose either the *EXE 1 (Debugger)* tab or the *EXE 2 (Programmer)* tab (Figure 4-17) in the *Environment Settings* dialog to bring either tab to the front. Enter options for the general-purpose external programs, for example, the ICS05CW, that you will be using with this project.

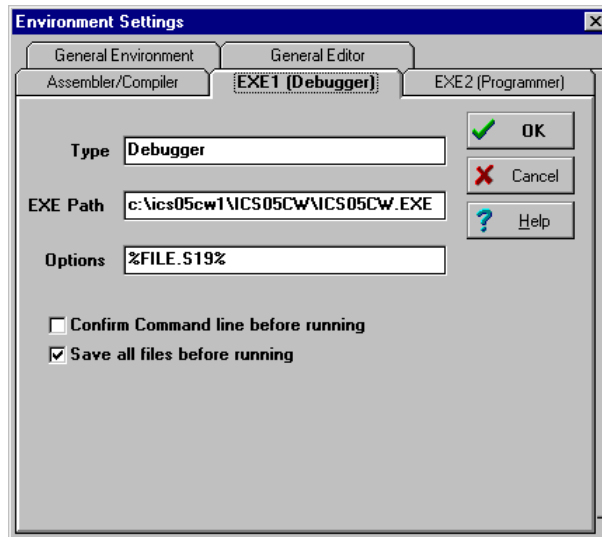

**Figure 4-17. Environment Settings Dialog:
EXE 1 (Debugger) and EXE 2 (Programmer) Tabs**

NOTE

The options are the same in both tabs.

- **Type:** Enter a description of the executable type in the *Type* text box. This string will appear in other parts of WinIDE editor. The default for Executable 1 is *Debugger*. For the ICS05CW, you may choose to change the Type to ICS. This will change the label on this tab and elsewhere in the dialog.
 - **EXE Path:** Enter the full path and executable name of Executable 1 in the *EXE Path* text box. The executable name may have an *EXE*, *COM*, or *BAT* extension. For a DOS-based executable or batch file, you may choose to create a *PIF* file to prevent the screen from changing video modes when the file is run.
 - **Options:** Enter the options you want to pass to the executable on the command line in the *Options* text box. In general, options will consist of switches that instruct the executable from the command line. You may add a filename using the *%FILE%* string. The *%FILE%* string inserts either the currently active filename, or the filename specified by the *%FILE%* parameter, set in the *%FILE%* parameters to pass to external programs field in the *General Environment* tab.

- **Confirm Command line before running:** Select this option to display a window describing the executable to be run and the parameters which will be passed, just before the assembler/compiler is run. This gives you the option to cancel the assemble/compile, continue as described, or modify parameters before continuing. If you do not select this option, the assembler/compiler will be run without prompting you to confirm parameters.
- **Save all files before running:** Select this option to save all open files to disk before running the executable. This is important since external programs that must read the edit file read only the last version saved to disk. In general, always select this option.
- **Wait for program completion:** Select this option to have the WinIDE editor disable itself until the executable terminates. If you do not select this option, the editor starts the compiler, and allows Windows to manage the program.

4.10.6 Setup Fonts

Select the *Setup Fonts* option in the Environment menu to open the *Setup Fonts* dialog (Figure 4-18) to change font options in the editor.

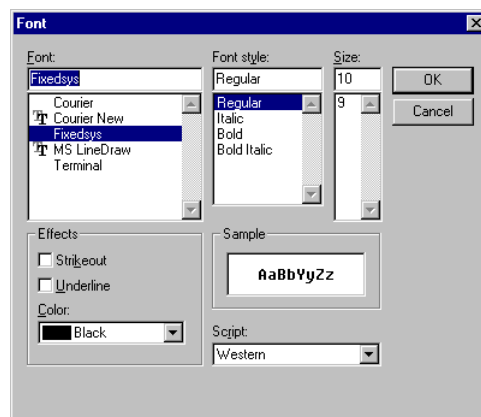

Figure 4-18. Setup Fonts Dialog

- **Font:** The *Font* text box displays the name of the current font. To change the current font, select another font name from the *Font* list. Use the scroll arrows if necessary to view all the font choices.
- **Font Style:** The *Font Style* text box displays the name of the current font style. To change the current font style, select another font style name from the *Font Style* list.
- **Size:** The *Size* text box displays the current font size. To change the size, enter a new number in the text box or choose a font size from the list.

- **Effects:** Toggle special font effects:
 - **Strikeout:** Choose this option to produce a horizontal strike-through line in the selected text
 - **Underline:** Choose this option to produce a horizontal underscore line below the selected text
- **Color:** Choose the text color from the drop-down list box. Click on the downward pointing arrow to display the *Color* list. Use the scrolling arrows to view all of the choices, if necessary.
- **Sample:** As you choose *Font* options, an example of the text that will result is shown in the *Sample* area.
- **Script:** If you have installed multilingual support, use this option to choose a non-western script.

4.11 WinIDE SEARCH OPTIONS

This section describes the WinIDE Search menu options for specifying search criteria and entering a line number to go to in a source file.

To perform a search operation, click once on the Search menu to open the menu (Figure 4-19). Click on the option to execute.



Figure 4-19. Search Menu

4.11.1 Find

Choose the *Find* option from the Search menu to open the *Find* dialog (Figure 4-20). In the *Find what:* box, enter the string to search for. The search will be performed in the active WinIDE editor source window.

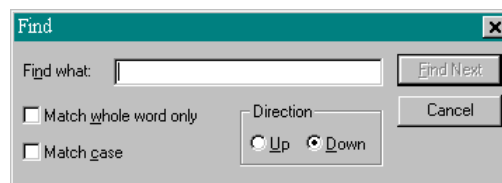

Figure 4-20. Find Dialog

Enter the search string and choose from the following options to refine your search:

- **Match Whole Word Only:** choose this option to limit the search to whole "words" and not character strings that are part of a longer word or string.
- **Match Case:** choose this option to perform a case sensitive search, that is, to find words with a specific uppercase and/or lowercase arrangement.
- **Direction:** Up/Down: Click on an option to direct the search:
 - Choose the *Down* option to direct the search from the current cursor position in the text to the end or "bottom" of the file.
 - Choose the *Up* option to direct the search from the current position in the text to the beginning or "top" of the file.

Press the Find Next button to start the search.

NOTE

The Find window is modeless and can remain open, allowing you to interact with either the *Find* dialog or the source window.

Alternatives: Press **Ctrl + F**. This is the keyboard equivalent to selecting the **Search - Find** menu option.

4.11.2 Replace

Select the *Replace* option to open the *Replace* dialog (Figure 4-21) to search for and substitute text in the active source window.

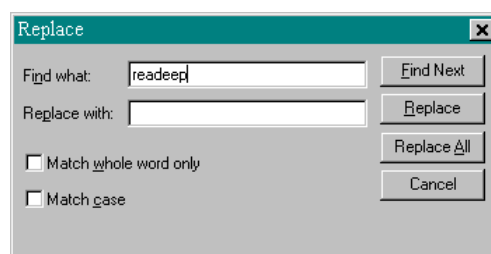

Figure 4-21. Replace Dialog

In the *Find what* text box, enter the text string to find; in the *Replace with* text box, enter the text string to replace it with. Refine the search using the *Match whole word only* or *Match case* options.

- **Match Whole Word Only:** choose this option to limit the search to whole "words" and not character strings that are part of a longer word or string

- **Match Case:** choose this option to perform a case sensitive search, that is, to find words with a specific uppercase and/or lowercase arrangement.

Press the Cancel button to close the *Replace* dialog.

Alternatives: Press **Ctrl + R**. This is the keyboard equivalent to selecting the **Search - Replace** menu option.

4.11.3 Find Next

Select the *Find Next* option from the Search menu to find the next occurrence of the previous search string without displaying the *Find* dialog.

Alternatives: Press **F3**. This is the keyboard equivalent to selecting the **Search - Find Next** menu option.

4.11.4 Go to Line

Select the *Go to Line* option from the Search menu to open the *Go to Line Number* dialog (Figure 4-22). You may note line numbers in the Status Bar and use the dialog to navigate between points in the text.

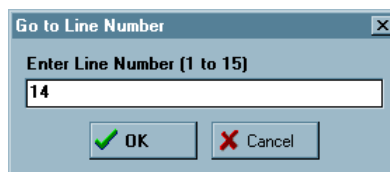

Figure 4-22. Go To Line Number Dialog

The dialog instruction includes the range of line numbers available in the active window. Enter the Line Number you want to go to, and press the OK button.

4.12 WinIDE WINDOW OPTIONS

This section describes the WinIDE Window menu options for managing the arrangement of open client windows in the main WinIDE window.

To perform a Window operation, click once on the Window menu to open the menu (Figure 4-23). Click on the option to execute.

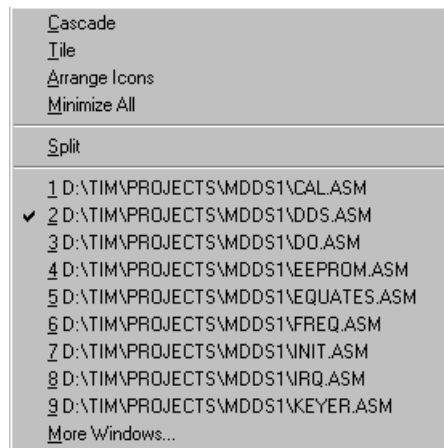

Figure 4-23. The Window Menu

4.12.1 Cascade

Select the *Cascade* option from the Window menu to arrange the open source windows in overlapping or "cascaded" style (Figure 4-24), like fanned cards. In this arrangement, open source windows are all set to the same size and shape, one overlapping the other from the upper left hand to the lower right hand corner of the WinIDE main window, with their title bars visible.

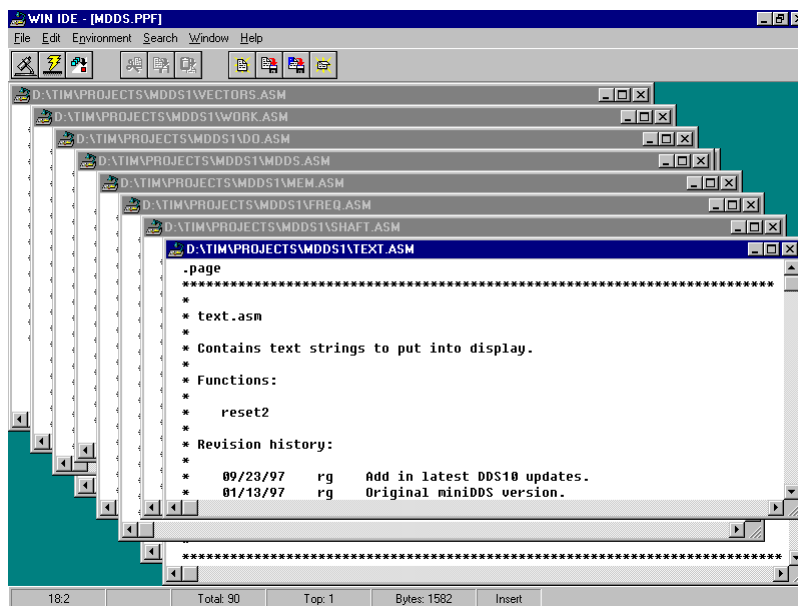

Figure 4-24. WinIDE with Subordinate Windows Cascaded

To choose a window from the cascaded display, click on its title bar. This moves the selected window to the top of the stack, and makes it the active window.

4.12.2 Tile

Select the *Tile* option from the Window menu to arrange the open source windows in tiled fashion (Figure 4-25). You will be able to see the entire window border for each, although not necessarily the window's entire contents.

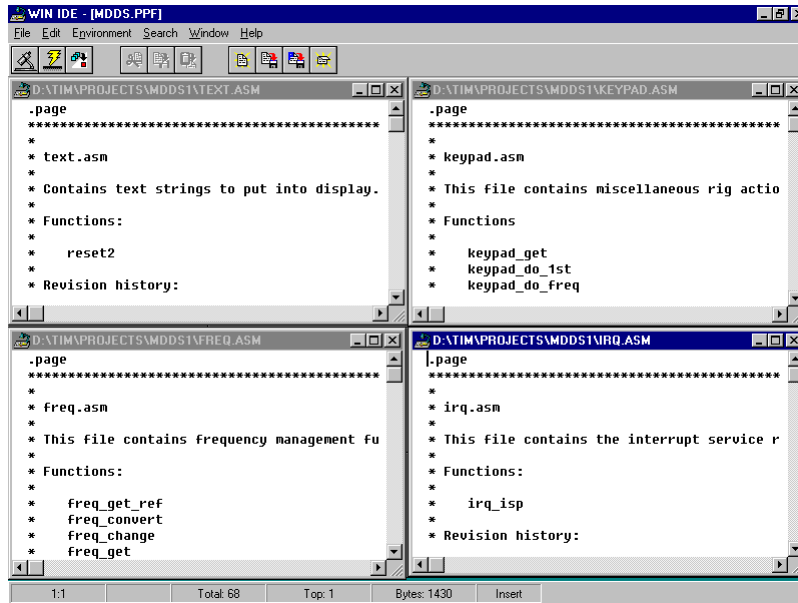
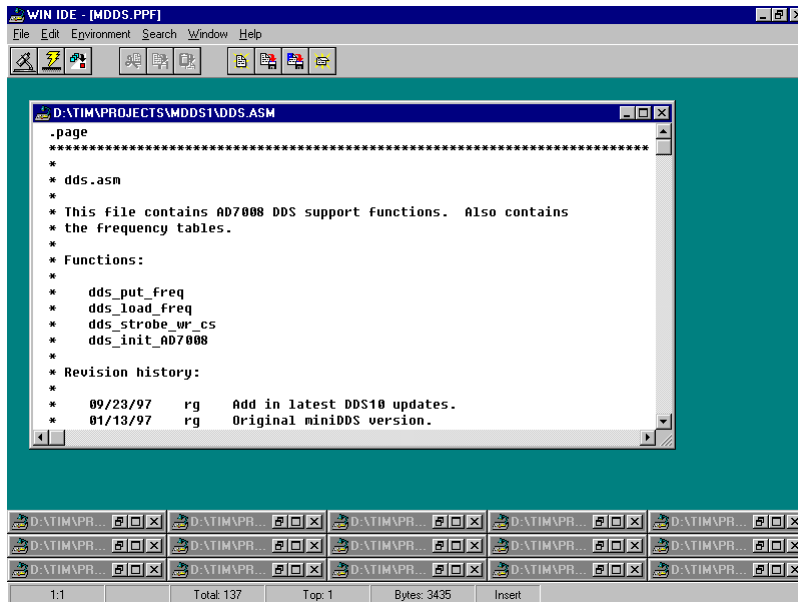

Figure 4-25. WinIDE with Subordinate Windows Tiled

If the contents of a source window cannot be displayed in their entirety, use the scroll bars. The tiled arrangement is practical to use when cutting and pasting from one window to another.

4.12.3 Arrange Icons

Select the *Arrange Icons* option from the Window menu to rearrange the icons of minimized windows into columns and rows at the bottom of the WinIDE main window (Figure 4-26).



**Figure 4-26. WinIDE
with One Source Window Displayed and Remaining Windows Minimized**

4.12.4 Minimize All

Select the *Minimize All* option from the Window menu to minimize all open source windows and display them as icons at the bottom of the WinIDE main window (Figure 4-27).

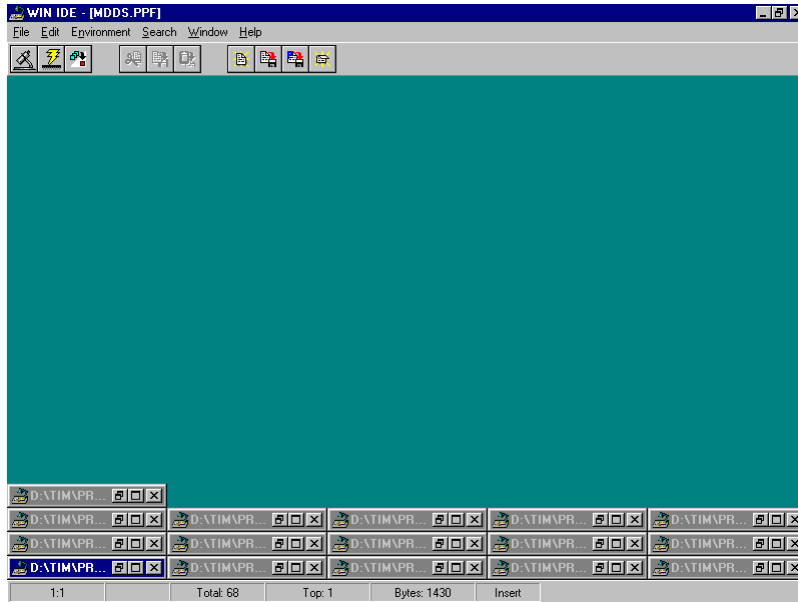

Figure 4-27. The WinIDE Editor with Subordinate Windows Minimized

4.12.5 Split

Select the *Split* option from the Window menu to divide the active source window into two or more separate panes, each capable of displaying a different view of the same file. To toggle the split window view, click on the *Split* option. A check mark appears beside the option when the split view is in effect.

Adjust the relative size of the panes by dragging the split bar, a double horizontal line separating the panes. Position the pointer over the split bar until it changes to the split pointer (Figure 4-28).

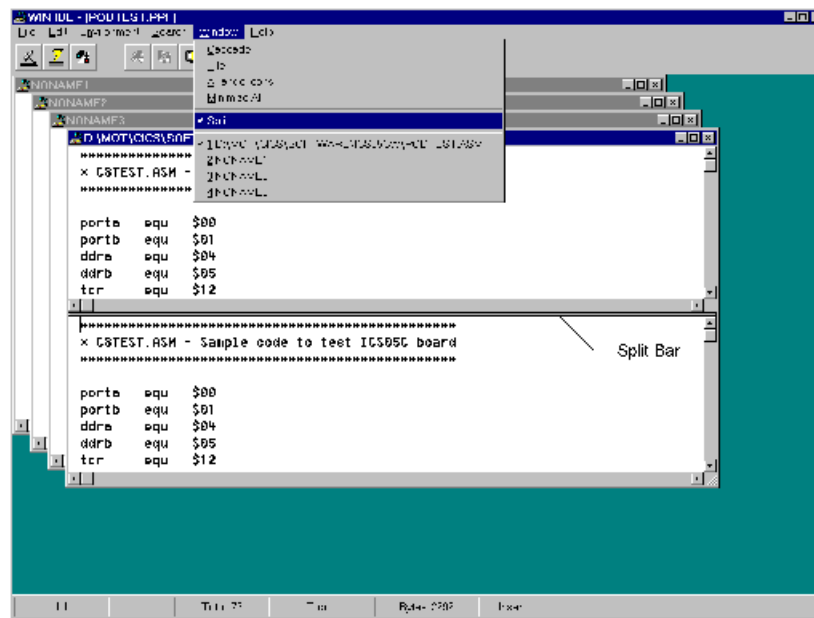

Figure 4-28. Cascaded Windows with Active Window Split

CHAPTER 5

ASSEMBLER INTERFACE

5.1 OVERVIEW

This chapter describes the operation of the CASM05W assembler, including methods for interfacing with the assembler from the WinIDE, setting assembler options and directives, generating and using output files and formats, and understanding assembler-generated error messages.

In order to be used in the target microcontroller CPU, the source code for your program must be converted from its mnemonic codes to the machine code that the target CPU can execute. The CASM assembler program accomplishes this by reading the source code mnemonics and assembling an object code file that can be programmed into the memory of the target microcontroller. Depending on the parameters that you specify for the assembler, other supporting files can be produced that are helpful in the debugging process.

When you click on the Assemble/Compile file button in the WinIDE, the CASM cross assembler is activated to process the active file in the WinIDE main window according to the parameters you have entered. In addition to two kinds of object code files, you may choose to have the assembler produce .MAP and/or .LST files as well.

Listing files show the original source code, or mnemonics, including comments, as well as the object code translation. You can use this listing during the debugging phase of the development project. It also provides a basis for documenting the program.

5.2 CASM05WASSEMBLER USER INTERFACE

The assembler interface consists of a window that appears briefly in the WinIDE main window during assembly. This window (Figure 5-1) contains information about the file being assembled:

- **Main File:** the path and filename of the main file being assembled
- **Current File:** the path and filename of the current file being assembled
- **Status:** the assembler status as the assembly proceeds
- **Current Line:** the current line position of the assembler
- **Total Lines:** the total number of lines in the file being assembled

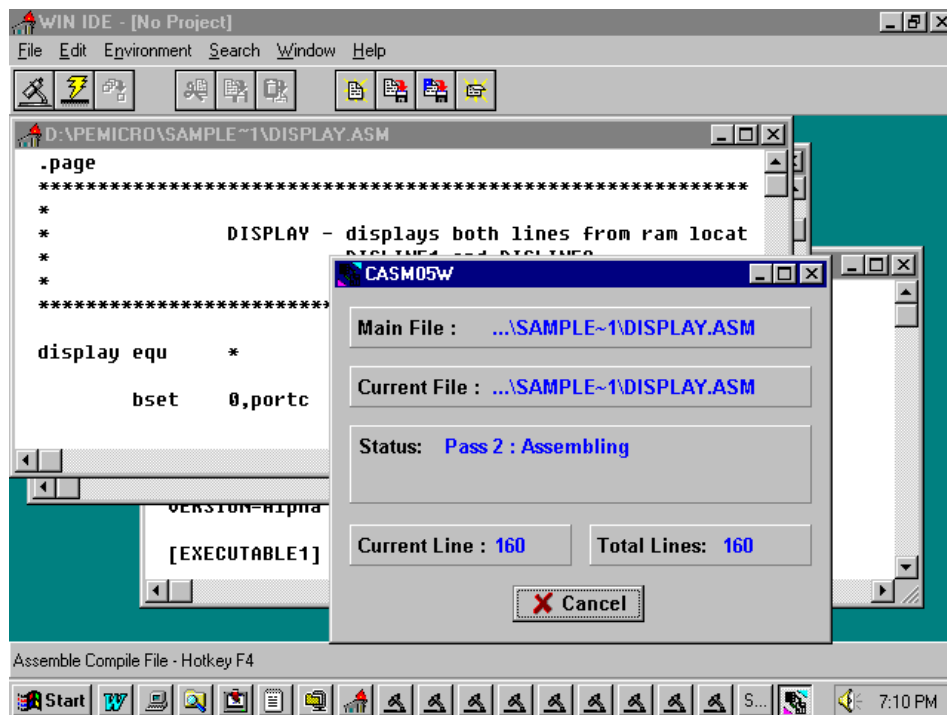

**Figure 5-1. WinIDE
with CASM05W Assembler Window Displayed**

You can pass parameters to the assembler by modifying the command line in the Program Item properties in Windows, as shown in Figure 5-2.

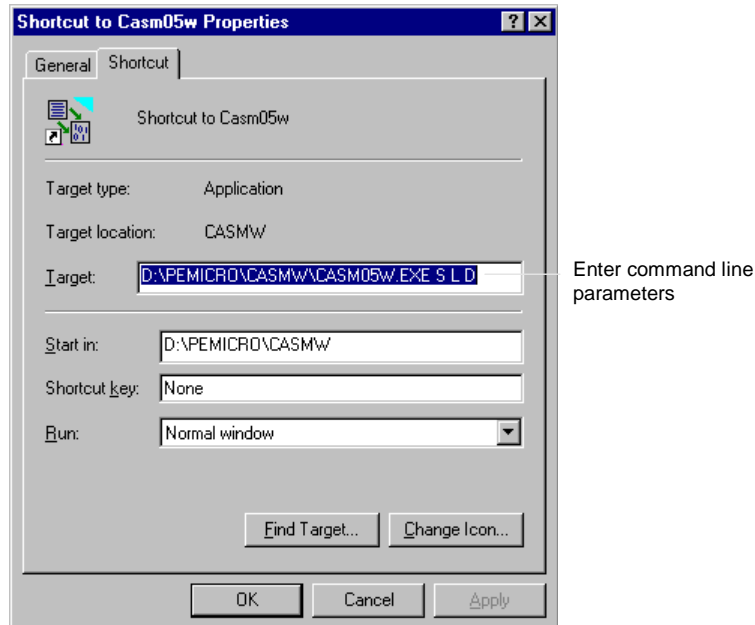

Figure 5-2. Windows 95 Program Item Property Sheet (Shortcut Property for CASM05W.EXE)

5.2.1 Passing Command Line Parameters to the Assembler in Windows 3.x

To enter parameters for the CASM05W assembler in Windows 3.x:

1. In the Windows Program Manager, select the CASMW icon.
2. Choose the Properties option from the Program Manager File menu (or type ALT F + P).
3. In the *Program Item Properties* dialog box enter the *Command Line* information. The command line specifies the command that will execute to start the program. In general, use the path to the program and its executable file name as the command line entry. You may also add optional command-line switches or parameters and the name of a specific file to run.

5.2.2 Passing Command Line Parameters to the Assembler in Windows 95

To enter parameters for the CASM05W assembler in Windows 95:

1. If the program is not running, right-click its icon on the Windows desktop, or its shortcut entry in a folder or Windows Explorer window to open the *Shortcut Properties* sheet (Figure 5-2).
2. In the *Target* textbox, enter the CASM05W command line parameters.
3. If necessary, edit the pathname in the *Start in* text box.
4. Choose the window type in which to run the assembler:
 - Choose *Normal* to run the assembler in a standard CASM05W window (Figure 5-3).
 - Choose *Minimized* to run the assembler in a minimized CASM05W window.
 - Choose *Maximized* to run the assembler in a maximized CASM05W window.

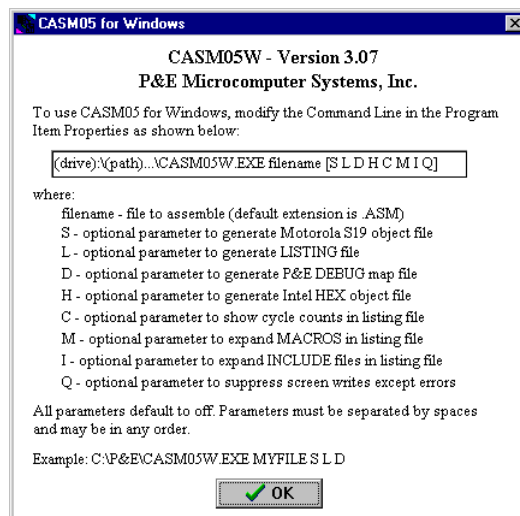

Figure 5-3. CASM05W for Windows Assembler Parameters

5.3 ASSEMBLER PARAMETERS

You may configure the CASM05W assembler using the following parameters in the Windows command line.

If you specify multiple parameters, separate them by spaces. You can enter the parameters in any order. All parameters default to off.

- **Filename:** Required parameter specifying the pathname and filename of the CASM05W assembler executable
- **S:** Optional parameter to general Motorola .S19 S-Record object file
- **L:** Optional parameter to general an .LST listing file
- **D:** Optional parameter to generate P&E .MAP debugging file
- **H:** Optional parameter to generate Intel HEX object file
- **C:** Optional parameter to show cycle counts in listing file
- **M:** Optional parameter to expand MACROS is listing file
- **I:** Optional parameter to expand INCLUDE files in listing file
- **Q:** Optional parameter to suppress screen writes except errors

Example

```
C:\P&E\CASM05#.EXE MYFILE S L D
```

5.4 ASSEMBLER OUTPUTS

5.4.1 Object Files

If you specify an object file in the command-line in the Program Item Properties in Windows, using the S or H parameters, the object file is created during assembly. The object file has the same name as the file being assembled, with the extension .HEX or .S19, depending on the specification given:

- Motorola uses the S-Record 8-bit object code file format for object files. For more information, see Appendix A: S-Record Information.
- .HEX is the Intel 8-bit object code format.

In either case, the object code file produced by the CASM05W assembler is a text file containing numbers that represent the binary opcodes and data of the assembled program. This object code file can be sent to the MCU using a programmer or bootstrap program, at which time it is converted to the binary format required by the target CPU.

The object filename depends on the choice made in the command line of the Windows Program Item Properties. By default, the object filename is that of the file being assembled, with the proper object file format extensions. An existing file with the same name will be overwritten.

5.4.2 Map Files

If you specify a map file using the D parameter, the P&E Debug .MAP file is created during the assembly. P&E Microcomputer products (such as the MMDS and the MMEVS) use these map files during the source-level debugging process.

Map files contain the directory path information under which they are created, and cannot, therefore, be moved to a new directory. If you must use the map file from a different directory, place the file in the new directory and reassemble, using the map file option D in the Windows command line.

5.4.3 Listing Files

If you specify a listing file using the L parameter in the Windows command line, a file with the same name as the file being assembled and the extension LST can be produced by the assembler. This file serves as a program listing showing the binary numbers that the CPU needs, alongside the assembly language statements from the source code.

For more information about using the assembler listing directives, see the summary of Assembler Directives in Table 5-2, beginning in paragraph 5-6.

5.4.4 Files from Other Assemblers

It is possible to use files produced by another assembler with the CASM05W assembler, providing they are properly prepared before using. To prepare a source file from a third-party assembler for use with the CASM05W, follow these steps:

1. Precede all comments by a semicolon.
2. Using the WinIDE (or other editor) global search and replace command, change any assembler-specific directives, listing directives, pseudo operations, etc., as required to create a file which is compatible with the CASM05W. Remember that assembler directives must begin with the characters \$, /, ., or #, and must begin in column 1.
3. If necessary, use the BASE directive to change the default base for the operands (CASM05W defaults to hexadecimal base).

5.5 ASSEMBLER OPTIONS

The CASM05W assembler supports all Motorola opcode mnemonics in the command set. For descriptions of the debugging commands, see Chapter 7, ICS05CW Debugging Command Set.

NOTE

Opcodes mnemonics cannot start in column one. If a label begins the line, there must be at least one space between the label and the opcode.

5.5.1 Operands and Constants

Operands are addresses, labels, or constants, as defined by the opcode. Assembly-time arithmetic is allowed within operands. Such arithmetic may use these operations:

*	multiplication
/	division
+	addition
-	subtraction
<	left shift
>	right shift
%	remainder after division
&	bitwise and
	bitwise or
^	bitwise xor

Operator precedence follows algebraic rules. You may use parentheses to alter precedence. If your expression contains more than one operator, parenthesis, or embedded space, you must put the entire expression inside braces ({ }).

```
jmp start           ;start is a previously defined label
jmp start+3        ;jump to location start + 3
jmp (start > 2)    ;jump to location start divided by 4
```

Constants are specific numbers in assembly-language commands. The default base for constants is hexadecimal, but you may change the default using the *Change Base Address* dialogs for the Memory and Code windows. To temporarily override the default base, use either the appropriate prefix or suffix (Table 5-1), but not both.

The assembler also accepts ASCII constants. Specify an ASCII constant by enclosing it in single or double quotes. A character ASCII constant has an equivalent value: 'A' is the same as 41H. An example of a string constant is:

```
db "this is a string"
```

Table 5-1. Change Base Prefixes/Suffixes

Base	Prefix	Suffix
2	%	Q
8	@	O
10	!	T
16		H

5.5.2 Comments

Use semicolons to delineate comments. A comment may start in any column and runs until the end of its line. Additionally, if any line has an asterisk (*) or semicolon (;) in column 1, the entire line is a comment.

5.6 ASSEMBLER DIRECTIVES

Assembler directives are keywords that control the progress and the modes of the CASM05W assembler. To invoke an assembler directive, enter a /, #, or \$ as the first character of a line. Enter the directive immediately after this initial character, along with the appropriate parameters values.

Directives supported by the assembler vary according to manufacturer. Table 5-2 summarizes the CASM05W assembler directives. A caret (^) indicates that a parameter value must follow the directive. Note also that a space must separate a directive and its parameter value.

5.6.1 BASE

The **BASE** assembler directive changes the default base of the current file. The parameter specified must be in the current base or have a base qualifier (prefix or suffix). The next base remains in effect until the end of the file, or until you enter another **BASE** directive.

The original default base is hexadecimal, but you can change the default to binary, octal, or decimal default bases instead. It is good practice to specify a base explicitly so that you are always sure that base is currently in effect.

5.6.2 Cycle Adder

The CASM05W assembler contains an internal counter for instruction cycles called the cycle adder. Two assembler directives, `CYCLE_ADDER_ON` and `CYCLE_ADDER_OFF`, control this counter.

When the assembler encounters the `CYCLE_ADDER_ON` directive, it clears the cycle adder. The cycle adder starts a running total of instruction cycles as subsequent instructions are assembled. For instructions that have variable numbers of instruction cycles, the cycle adder uses the smallest number.

When the assembler encounters the `CYCLE_ADDER_OFF` directive, it writes the current cycle-adder value to the `.LST` file and disables the cycle adder.

Table 5-2. Assembler Directives

Directive	Action
BASE ^	Change the default input base to binary, octal, decimal, or hexadecimal
CYCLE_ADDER_OFF	Stop accumulating instruction cycles and print the total
CYCLE_ADDER_ON	Start accumulating instruction cycles
INCLUDE ^	Include specified file in source code
MACRO ^	Create a macro
MACROEND	End a macro definition
RAMEND ^	Set logical end of RAM space
RAMSTART ^	Set default for ramloc pseudo operation
Conditional Directive	Action
SET	Sets the value of its parameter to true. Maximum number of SETs is 25.
SETNOT	Sets the value of its parameter to false. Maximum number of SETNOTs is 25.
IF or IFNOT	Determines the block of code to be used for conditional assembly; the code between the IF and ENDIF will be assembled if the given parameter value is true; the code between IFNOT and ENDIF will be assembled if the parameter value is false.
ELSEIF	Provides alternative to ENDIF when precedes ENDIF; for example, if the parameter value is true, the code between IF and ELSEIF will be assembled, but the code between ELSEIF and ENDIF will not be assembled. If the parameter value is false, code between IF and ELSEIF will not be assembled, but code between ELSEIF and ENDIF will be assembled. ELSEIF gives the same alternative arrangement to a directive sequence that begins with IFNOT.
ENDIF	See IF, IFNOT, ELSEIF

5.6.3 Conditional Assembly

The CASM05W assembler allows you to specify blocks of code to be assembled only upon certain conditions. To set up such conditional assembly procedures, use the conditional assembler directives summarized in Table 5.2.

Example of Conditional Assembly Directives

```
$SET debug           ;sets debug = true
$SETNOT test         ;sets test = false
nop                  ;always assembles
nop                  ;always assembles
$IF debug            ;if debug = true
  jmp start          ;assembles
$ELSEIF              ;if debug = false
  jmp end            ;does not assemble
$ENDIF ;
nop                  ;always assembles
nop                  ;always assembles
$IF test             ;if test = true
  jmp test           ;does not assemble
$ENDIF ;
```

5.6.4 INCLUDE

If the CASM05W assembler encounters the INCLUDE directive, it takes source code from the specified file and continues until it encounters another INCLUDE directive or until it reaches the end of the main file. When the assembler reaches the end of the main file, it continues taking source code from the file that contained the include directive.

The file specification of the INCLUDE directive must be in either single or double quotes. If the file is not in the current directory, the specification should also include the full path name as well as the filename.

You may nest included to a maximum depth of 10, that is, each included file may contain up to 10 additional included files.

Examples

```
$INCLUDE "INIT.ASM"
$INCLUDE "C:\project\init.asm*"
```

5.6.5 MACRO

A macro is a named block of text to be assembled. Similar in some ways to an included file, the macro allows labels and parameter values.

The MACRO directive begins the macro definition. The name of the macro is the parameter value for the MACRO direction. All subsequent code, until the assembler encounters the MACROEND directive, is considered the macro definition.

No assembler directives may be used within a macro, no does the definition require parameter names. Instead, the macro definition includes the sequential indicators %n for the nth parameter values of the macro call. The assembler will ignore parameter values on the MACRO directive line, so such values may be helpful for internal documentation.

Example

This macro example illustrates a macro that divides the accumulator value by 4:

```

$MACRO divide_by_4      ;starts macro definition
asr a                  ;divides accumulator by 2
asr a                  ;divides quotient by 2
$MACROEND              ;ends macro definition

```

This macro example illustrates a macro that creates a time delay:

```

$MACRO delay           count
                        ldaa #$01
loop:                  deca
                        bne loop
$MACROEND

```

In this macro, the CASM05W assembler ignores the parameter *count* on the MACRO directive line. The parameter *count* merely indicates the role of the parameter value passed to the macro. That value is substituted for the sequential indicator %1. The first time this macro is called, the CASM05W assembler changes the label *loop*, on lines 3 and 4, to *loop:0001*. If the calling line

```
delay 100t
```

invokes this macro, the loop would occur 100 times. The suffix *t* represents the decimal base.

The CASM05W assembler ignores extra parameter values sent to a macro. If the macro does not receive enough parameter values, the assembler issues an error message.

Labels change automatically each time they are used. Labels used within macros may not be longer than 10 characters, because the assembler appends a four-digit hexadecimal number to the label to insure label uniqueness.

Although code may not jump into a macro, it may jump out of a macro. Macros cannot be forward-referenced.

5.7 LISTING DIRECTIVES

List directives are source-code keywords that control output to the LST listing file. These directives pertain only to viewing the source-code output; the directives, which may be interspersed anywhere in source code, do not affect the actual code assembled. Table 5-4 summarizes the listing directives.

Table 5-3. Listing Directives

Directive	Action
eject or page	Begins a new page
header ^	Specifies a header on listing pages; the header can be defined only once; the default header is blank; the header string is entered in quotes.
list	Turns on the .lst file output.
nolist	Turns off the .lst file output. This directive is the counterpart of the list directive; at the end of a file, this directive keeps the symbol-table from being listed.
pagelength ^	Sets the length of the page; the default parameter value is 166 lines (! = decimal)
pagewidth ^	Sets the width of the output, word wrapping additional text; the default parameter value is 160 columns (! = decimal)f.
subheader ‘^’	Makes the string specified in quotes (double or single) a subheader on the listing pages; the subheader takes effect on the next page.
Note: the caret (^) character following a directive indicates a mandatory parameter value that must be supplied.	

5.7.1 Listing Files

If a listing file is requested using the L parameter in the command line of the Windows Program Item Properties, or the *Output Listing File* option is checked in the *Assembler/Compiler* tab in the *Environment Settings* dialog, the listing file (.LST) is created during the assembly.

This listing file has the same name as the file being assembled, but with the extension .LST. Any existing file with the same name will be overwritten.

The listing file has the following format (file fields shown in the example are described in Table 5-4):

```
AAAA                [CC]   VVVVVVVV   LLLL Source Code   .
. . . .
```

Example:

```
0202                [05]   1608 37   bset 3,tcsr       ;clear
timer overflow flag
```

The listing file fields are described in Table 5-4.

Table 5-4. Listing File Fields

Field Contents	Field Description
AAAA	The first field contains four hexadecimal digits indicating the address of the command in the target processor (MCU) memory. The assembler generates this field.
[CC]	The second field indicates the number of machine cycles used by the opcode. . The assembler generates this field. Note that this value appears only if the cycle counter (Cycle Cntr) was turned on before assembly. Also note that the CC value, which always appears in brackets, is a decimal value. If a command has several possible cycle counts and the assembler cannot determine the actual number, the CC field shows the best case (lowest number). An example of a command that may have several possible counts is a branch command.
VVVVVVVV	The third field contains a label consisting of four hexadecimal digits indicating the values placed into that memory address (and, possibly, the next several memory addresses). You may refer to this label in other commands. The size of this field depends on the actual opcode. The assembler derives this field from the source code.
LLLL	The fourth field may contain up to four digits indicating the line count. The assembler derives this field from the source code.
Source code	The last field contains the actual source code from the source code file.
Listing table	The listing table provides a summary of every label and its value, displayed in table format at the end of each listing file.

Example Listing Table

MAIN1.ASM Assembled with CASMW 2/27/97 12:06:39 PM PAGE 2

```
0000                    26    porta    equ     $0000
0000                    27    portb    equ     $0001
0000                    28    portc    equ     $0002
0000                    29    portd    equ     $0003
0000                    30    ddra     equ     $0004
0000                    31    ddrb     equ     $0005
0000                    32    ddrc     equ     $0006
0000                    33    ddrd     equ     $0007
```

. . . .
Symbol Table

```
DONSCN                08DD
DONSCN1               08EE
OPTSC1                0866
OPTSC2                0877
OPTSC3                0888
. . . .
```

5.7.2 Labels

As you write the program code, you will not necessarily know the addresses where commands will be located. The assembler solves this problem using a system of labels, providing you with a convenient way to identify specific points in the program without knowing the exact addresses. The assembler later converts these mnemonic labels into specific memory addresses and even calculates the offsets for branch commands in order for the CPU to use them.

Labels within macros must not exceed 10 characters in length.

Examples:

```
Label:
ThisIsALabel:
Loop_1
This_label_is_much_too_long:
```

The assembler would truncate the last example to 16 characters.

5.8 PSEUDO OPERATIONS

The CASM05W assembler also allows pseudo operations (in place of opcode mnemonics). The operations that the assembler allows are summarized in Table 5-5.

Table 5-5. Pseudo Operations Allowed by the CASM05W

Pseudo Op Code	Action
equ	Associates a binary value with a label.
fcb m or db m	Defines byte storage, where m = label, number, or string. Strings generate ASCII code for multiple bytes; number and label parameters receive single bytes. Separate multiple parameters with commas.
fdb n or dw n	Defines word storage, where n = label, number, or string. Two bytes are generated for each number or label. Separate multiple parameters with commas.
org n	Sets the origin to the value of the number or label n. No forward references of n are allowed.
rmb n or ds n	Defines storage, reserving n bytes, where n = number or label; no forward references of n are allowed.

5.8.1 Equate (EQU)

The equate directive associates a binary value with a label. The value may be either an 8-bit value or a 16-bit address value. This directive does not generate any object code.

During the assembly process, the assembler must keep a cross-reference list where it stores the binary equivalent of each label. When a label appears in the source program, the assembler looks in this cross-reference table to find the binary equivalent. Each EQU directive generates an entry in this cross-reference table.

An assembler reads the source program twice. On the first pass, the assembler just counts bytes of object code and internally builds the cross-reference table. On the second pass, the assembler generates the listing file and/or the S-record object file, as specified in the command line parameters for the assembler. This two-pass arrangement allows the programmer to reference labels that are defined later in the program.

EQU directives should appear near the beginning of a program, before their labels are used by other program statements. If the assembler encounters a label before it has been defined, the assembler has no choice but to assume the worse case, and assign the label a 16-bit address value. This would cause the extended addressing mode to be used in places where the more efficient direct addressing mode could have been used. In other cases, the indexed 16-bit offset addressing mode may be used where a more efficient 8-bit or no offset indexed command could have been used.

5.8.2 Form Constant Byte (FCB)

The arguments for this assembler directive are labels or numbers (separated by commas) that the assembler can convert into a single byte of data. Each byte specified by the FCB directive generates a byte of machine code in the object code file. Use FCB directives to define constants in a program.

5.8.3 Form Double Byte (FDB)

The arguments for this assembler directive are labels or numbers (separated by commas) that the assembler can convert into 16-bit data values. Each argument specified in an FDB directive generates two bytes of machine code in the object code file.

5.8.4 Originate (ORG)

The originate directive sets the location counter for the assembler. The location counter keeps track of the address where the next byte of machine code will be stored in memory.

As the assembler translates program statements into machine code commands and data, it advances the location counter to point to the next available memory location.

Every program has at least one ORG directive, to establish the program's starting place. Most complete programs will also have a second ORG directive near the end of the program to set the location counter to the address where the reset and interrupt vectors are located. You must always specify the reset vector. It is good practice to also specify interrupt vectors, even if you do not expect to use interrupts.

5.8.5 Reserve Memory Byte (RMB)

Use this assembler directive to set aside space in RAM for program variables. The RMB directive does not generate any object code, but it normally generates an entry in the assembler's internal cross-reference table.

5.9 ASSEMBLER ERROR MESSAGES

You can configure the CASM05W assembler to highlight any errors that it encounters during assembly, and display an error message on the prompt line. Table 5-6 summarizes these messages.

Table 5-6. Assembler Error Messages

Message	Probable Cause	Corrective Action
Conditional assembly variable not found	The variable in the IF or IFNOT statement has not been declared via a SET or SETNOT directive.	Declare the variable using the SET or SETNOT directive.
Duplicate label	The label in the highlighted line already has been used.	Change the label to one not used already.
Error writing .LST or .MAP file—check disk space	Insufficient disk space or other reason prevents creation of an .LST or .MAP file.	Make sure there is sufficient disk space. Make sure that your CONFIG.SYS file lets multiple files to be open at the same time (see your DOS or Windows manual for commands).
Error writing object file—check disk space	Insufficient disk space or other reason prevents creation of an object file.	Make sure there is sufficient disk space. Make sure your CONFIG.SYS file allows multiple files to be open at the same time (see your DOS or Windows manual for commands).
Include directives nested too deep	Includes are nested 11 or more levels deep.	Nest includes no more than 10 levels deep.
INCLUDE file not found	Assembler could not find the file specified in the INCLUDE directive	Make sure that quotes enclose the file name to be included; if necessary, specify the full path name as well.
Invalid base value	Value inconsistent with current default base (binary, octal, decimal, or hexadecimal)	use a qualifier prefix or suffix for the value, or change the default base.
Invalid opcode, too long	The opcode on the highlighted line is wrong.	Correct the opcode.
MACRO label too long	A label in the macro has 11 or more characters.	Change the label to have no more than 10 characters,

Table 5-6. Assembler Error Messages (continued)

Message	Probable Cause	Corrective Action
MACRO parameter error	The macro did not receive sufficient parameter values.	Send sufficient parameter values to the macro.
Out of memory	The assembler ran out of system memory	Create a file that consists only of an INCLUDE directive, which specifies your primary file. Assembling this file leaves the maximum memory available to the assembler.
Parameter invalid, too large, missing or out of range	Operand field of the highlighted line has an invalid number representation. Or the parameter value evaluates to a number too large for memory space allocated to the command.	Correct the representation or change the parameter value.
Too many conditional assembly variables	There are 26 or more conditional variables.	Limit conditional variables to 25 or fewer.
Too many labels	The assembler ran out of system memory.	Create a file that consists only of an INCLUDE directive, which specifies your primary file. Assembling this file leaves the maximum memory available to the assembler.
Undefined label	The label parameter in the highlighted line has not been declared.	Declare the label.
Unrecognized operation	The highlighted opcode is unknown or is inconsistent with the number and type of parameters.	Correct the opcode or make it consistent with parameters.
'}' not found	A mathematical expression is missing its closing brace.	Insert the closing brace.

5.10 USING FILES FROM OTHER ASSEMBLERS

To prepare a source file made by another assembler with the CASM05W, follow these steps:

1. Divide large files into smaller files no larger than 75K. Typically, use one file for system variables and EQUates, another file for I/O routines. The main file should be the one called. Remember that include filenames must be in quotes and must contain the file extensions.
2. Make sure all comments in the source file are preceded by a semicolon.
3. Use the global find-and-replace operation in the editor to change any assembler directives, listing directives, and/or pseudo operations, if they exist in the source code. Remember that assembler directives must begin with the character \$, /,., or #, and must start in column 1.
4. If necessary, use the BASE directive to change the default base for operands (CASM05W defaults to hexadecimal).

CHAPTER 6

ICS05CW SIMULATOR USER INTERFACE

6.1 OVERVIEW

This chapter describes the in-circuit simulator user interface, toolbar buttons, windows, sub-windows, messages, and menu options.

6.2 THE ICS05CW IN-CIRCUIT SIMULATOR

The ICS05CW.EXE is an in-circuit simulator for Motorola 68HC05c series microcontrollers that runs in Windows 3.x and Windows 95. The ICS05CW can get inputs and outputs (I/O) for the target device from an external pod, the M68ICS05C board, that is attached to the host computer. If you want to use actual inputs and outputs (I/O) from your own target board, you may attach the M68ICS05C board to your target board using the supplied extension cable.

The ICS05CW in-circuit simulator software is the debugging component of a complete development environment when used in conjunction with the WinIDE editing environment and the CASM05W command-line assembler.

6.2.1 ICS05CW Simulation Speed

The ICS05CW is *not a real-time debugger*. The speed at which the simulator executes code is much slower than the speed at which the actual processor can execute code. Therefore, if there are any critical timing issues to be resolved, you should use an emulator for the HC05C devices instead of the ICS05CW.

Alternately, you may simulate using the slow mode, then program an EPROM device to check the full speed operation.

NOTE

An *actual* speed of 10KHz indicates that the simulator on your host PC is running at the same speed as the real MCU with a 20-KHz crystal (a divide-by-2 is attached to the internal oscillator output). Typical values for *actual* speed are 3 to 50 kHz.

To calculate *actual* speed of the assembled code on the target MCU, you need a stopwatch and some source code. Follow these steps:

1. Load your code using the LOAD command on the ICS05CW Status Window command line.
2. Set the program counter to the beginning of the routine for which you wish to measure the speed.
3. Clear the cycle counter using the CYCLE (or CY) command with the 0 parameter, then press Enter:
4. Ready your stopwatch.
5. Enter the GO or G command on the ICS05CW Status Window command line.
6. Start the stopwatch and press the ENTER button *simultaneously* to begin code execution.
7. After 10 seconds, simultaneously stop the watch and execution (the fastest way to stop execution is to press the spacebar). Execution halts.
8. Now enter the CYCLES or CY command on the Status Window command line; the decimal value cycle count is displayed.
9. Divide the cycle count by 10. The result is the *actual* speed in kHz.

6.2.2 System Requirements for Running the ICS05CW

The ICS05CW runs under Windows 3.1 or Windows 95. There is a separate 32-bit version of the ICS05CW software for Windows 95/NT available directly from P&E Microcomputer Systems.

Your host computer should have a minimum of 2 MB of RAM (system memory) available for assembly processes, as well as sufficient disk space to store the files that the ICS05CW creates.

6.2.3 File Types and Formats

You can use a number of file types in conjunction with the ICS05CW simulator. The following topics describe the use and structure of each type.

- **Project Files:** Project files store two types of information:
 - Desktop information includes all the information stored concerning the files that are currently open in the project. Whenever you save the project file, WinIDE records information about each window open in the desktop, including:
 - ◆ Window size
 - ◆ Window position

- ◆ Window style (Maximized/Minimized/Normal)
- ◆ Markers currently set
- Environment Settings
 - ◆ User settings
 - ◆ WinIDE configuration parameters as specified in *the Environment Settings* dialog tabs

When you open the project, or if the project is open when the WinIDE starts, files are all opened with the settings stored in the project file.

- **S19 (Object) Files:** The ICS05CW software accepts any standard Motorola S19 files as input for simulation. S19 object files can be created by any HC05 assembler (such as CASM05W), and contain the actual object code that is simulated by the ICS05CW. Specify the S19 files to use on the command line or load it using the LOAD command in the ICS05CW Status window.
 - The object file has the same name as the file assembled, with the extension .HEX or .S19, and contains the actual assembled (or object) code to debug. If you specify an object file in the environment settings, it is created during assembly.
 - The CASMW (and some other assemblers) product object files in the .S19 format. The Motorola S19 object code format is described in detail in Appendix A. HEX files are the Intel 8-bit object code format.
- **Map Files** contain source level debugging information. To debug symbolic or source code in the code window you must also load one or more P&E map-files. The *.MAP source-level map file can be generated by specifying the map files option on the command line when running the CASMW assembler, or loaded using the LOADMAP command in the ICS05CW Status window. If you specify a map file in the environment settings, it is created during assembly.

NOTE

Map files contain directory information, so cannot be moved. To place map files in another directory, move the map file to the new directory and reassemble the file in the new directory so the new map file will contain the correct directory information.

If you use a third party assembly language or C compiler, it must be able to produce compatible source-level map files.

- **Error Files** contain assembly error information. The CASMW highlights any errors that it encounters during the assembly, and displays the error message in the CASMW window. Depending on the environment settings, the assembler may also open the file in which the error was encountered, and create an error file with the assembly filename and the .ERR extension.

- **Script Files** are plain ASCII text files containing ICS05CW simulator commands. You may use any command in the ICS05C command set in script files. Running the script file then has the effect of entering the commands in it in the ICS05CW command line. You can create script files in the WinIDE editor, or you can use files created by other text editors following these rules:
 - Enter each command on its own line.
 - Preface comments with a semi-colon.
 - Use commands from the ICS05CW command set and WAIT.
- **Listing Files** display each line of source code and the resulting (assembled or compiled) object code. Listing files show exactly how and where each code was assembled.
 - If you specify a listing file in the environment settings, it is created during assembly. The listing file will have the same name as the file being assembled, with the .LST extension, and will overwrite any previous file with the same name.
 - Listing files contains these fields in the following format:

```
AAAA [CC] VVVVVVVV LLLL Source Code . . . .
```

Where:

AAAA First four hexadecimal digits are the address of the command in the target processor memory.

[CC] The number of machine cycles used by the opcode. This value, which always appears in brackets, is a decimal value. If an instruction has several possible cycle counts (as would be the case when the assembler encounters a branch instruction) and the assembler cannot determine the actual number of cycle counts, the CC field will show the best case (lowest number).

VVVVVVVV Hexadecimal digits (the number of which depends on the actual opcode) representing values put into that memory address.

LLLL Line count.

Source code The actual source code

At the end of the listing file is the symbol table listing every label and its value.

- **Log Files** are simple ASCII text files, sometimes called scratch pad files. The log file records the sequence and content of commands executed, and the debugger responses to the commands. You can view log files from within the WinIDE editor. The ICS05CW simulator creates log files if the LOGFILE or LF command is active.

6.3 STARTING ICS05CW

You can start the ICS05CW simulator by itself in standalone mode (with no inputs or outputs from the target), or run it from within the WinIDE editor. You can also modify the ICS05CW environment in WinIDE editor.

- To run the simulator in standalone mode, double click the ICS05CW icon using either of these methods:
 - In Windows 3.x, in the Program Manager, double click the ICS05CW icon in the ICS05CW Program Group.
 - In Windows 95, choose the ICS05CW icon from the ICS05CW group in the Start menu.
- To run the simulator from the WinIDE editor, use either of these methods:
 - Click the Debugger (EXE1) button on the WinIDE toolbar
 - Press the F6 Hotkey
- To modify how the software starts from WinIDE editor:
 1. From the WinIDE Environment menu, choose the Setup Environment option to open the Environment Settings dialog.
 2. Select the EXE1 Debugger tab heading (see Figure 4-17), if it is not in already on top, to set options for the ICS05CW simulator. For more information about the options in the tab, see paragraph 4.10.5.4.

After startup, the software will establish communication with the board at the given parameters and the status bar will read *Attempting to contact COM 1*.

- If the ICS05CW software can communicate with the pod through the serial port, the status bar message reads, *Contact with pod established*.

- If the software is not able to connect with the board, the *Can't Contact Board* dialog (Figure 6-1) appears.

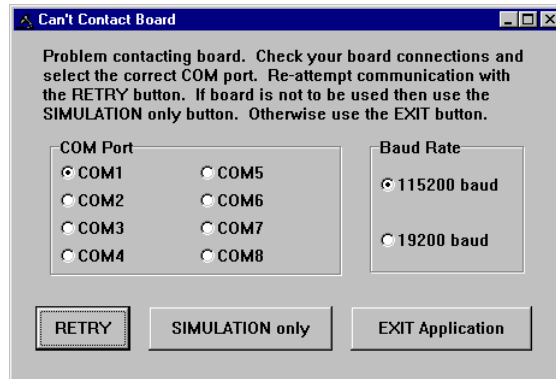

Figure 6-1. *Can't Contact Board* Dialog

If the communication parameters for the communications port and baud rate are incorrect in the *Can't Contact Board* dialog, change them and then press the RETRY button. If the board is not connected or you do not wish to use I/O from the board, then click the SIMULATION only button. Otherwise, press the EXIT Application button.

When you start the ICS05CW software for the first time, the *Pick Device* dialog offers choices of the C-series devices (chips). If you want to open this dialog and change the device later, enter the CHIPMODE command in the ICS05CW Status Window command line.

NOTE

If a file named STARTUP.05C exists in the current directory, the WinIDE runs it as a macro file on startup. See the MACRO command for more information.

6.4 ICS05CW WINDOWS

The ICS05CW user interface consists of windows in which system and code information is shown and into which the ICS05CW command set can be entered (Figure 6-2).

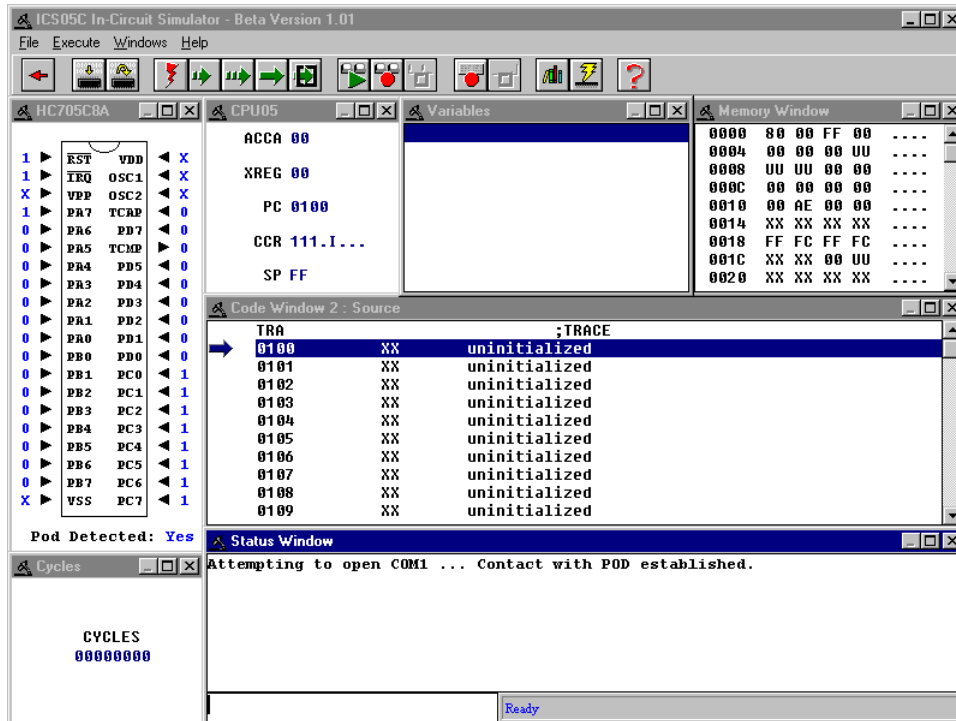

Figure 6-2. The ICS05CW Windows Default Positions

The ICS05CW also displays these sub-windows when appropriate:

- Stack Window
- Trace Window
- Breakpoint Window
- Programmer Windows
- Register Block Window

6.5 CODE WINDOWS

The Code windows (Code1 and Code2) can be set to display source code in either source or disassembly modes. Code windows also give visual positions of the current program counter (PC) and all breakpoints within the source code. You can display both code windows simultaneously. Each code window is independent: you can configure each window to display different parts of your source code, or different assembly modes.

The Code Window Shortcut menu contains options for working in the code windows (Figure 6-3).

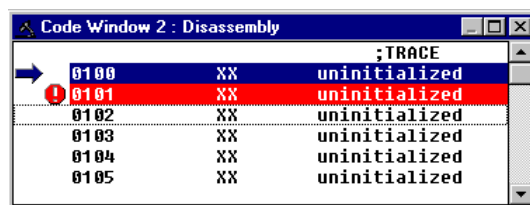

Figure 6-3. Code Window in Disassembly Mode with Breakpoint Toggled

6.5.1 To Display the Code Windows Shortcut Menus

To display the Code 1 or Code 2 Windows Shortcut Menu (Figure 6-4), position the cursor in either the Code1 or Code2 window and click the right mouse button.

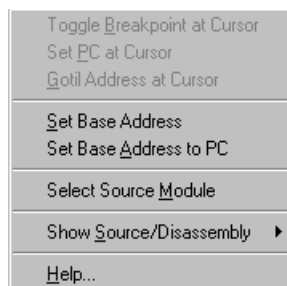

Figure 6-4. Code Window Shortcut Menu

6.5.2 Code Window Shortcut Menu Functions

The Code Window Shortcut Menu (Figure 6-4) offers these options:

- **Toggle Breakpoint at Cursor:** Choose this option to set or remove the breakpoint at the current cursor location.
- **Set PC at Cursor:** Choose this option to set the Program Counter (PC) to the current cursor location.
- **Goto Address at Cursor:** Choose this option to execute the source code until the Program Counter (PC) gets to the line at the current cursor location. When PC gets to that point, execution stops.
- **Set Base Address:** Choose this option to open the *Window Base Address* dialog (Figure 6-5) and set the new address for the first code line in the Code Window.

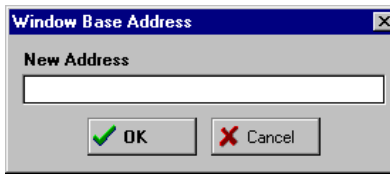

Figure 6-5. Window Base Address Dialog

- **Set Base Address to PC:** Choose this option to set the Program Counter (PC) to the address of the first line in the Code Window.
- **Select Source Module:** Choose this option to select a source module (if a MAP file has been loaded into memory).
- **Show Disassembly:** Choose this option to display the Code window contents in disassembly mode.
- **Show Source/Disassembly:** Choose this option to display the Code window contents in both disassembly and source modes.

6.5.3 Code Window Keyboard Commands

Use these keys to navigate in the Code Windows:

- Press the Up Arrow (\uparrow) key to scroll the Code Window contents up one line.
- Press the Down Arrow (\downarrow) key to scroll the Code Window contents down one line.
- Press the Home key to scroll to the Code Window's base address.
- Press the End key to scroll to the Code Window's last address.
- Press the Page Up key to scroll the Code Window up one page.
- Press the Page Down key to scroll the Code Window down one page.
- Press the F1 key to show the Help Contents topic.
- Press the Escape (Esc) key to move the cursor to the command line of the Status Window.

6.6 VARIABLES WINDOW

The Variables window (Figure 6-6) displays current variables during execution. Use the Variables window shortcut menu to add or remove variables from the current list.

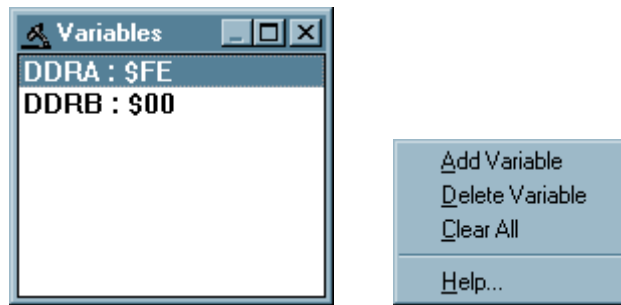

**Figure 6-6. Variables Window
with Shortcut Menu**

6.6.1 Displaying the Variables Shortcut Menu

To display the Variables shortcut menu, position the cursor in the Variables window and click the right mouse button.

6.6.2 Variables Window Shortcut Menu Options

The Variables Window Shortcut Menu offers these options for managing variables:

- **Add Variable:** Choose this option to open the *Add Variable* dialog (Figure 6-7) to add a variable or address to the current variable list. Select the variable type (size) and base.

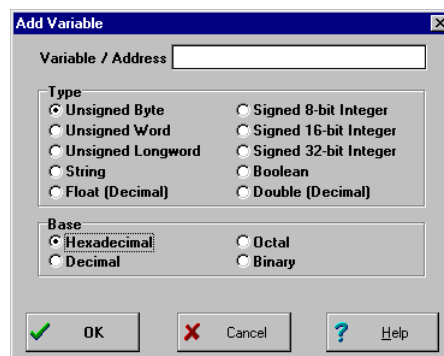

Figure 6-7. Add Variable Dialog

You may enter values for commands in the simulator as either labels (which you have defined in the map file or with the SYMBOL command), or as numbers. You may specify the base in which variables are shown using the options in the *Add Variable* dialog (Figure 6-7). The default number format for the ICS05CW is hexadecimal.

To override the default base for any number, you may also enter either a prefix or suffix (but not both) shown in Table 6-1 in the command lines.

Table 6-1. Base Prefixes and Suffixes

Base	Prefixes	Suffixes
16	'\$'	'H'
10	'!'	'T'
8	'@'	'O'
2	'%'	'Q'

Example

\$FF = !255 = @377 = %11111111 = 11111111Q = 377O = 255T =
OFFH

NOTE

If the '*' character is used as a parameter, the address of the cursor in the code window will be used (if it points to valid object code).

```
>PC 100      Change PC address to address $100.
>N 1        Assign value 1 to CCR N bit.
>MM C0 100T Place value 100 at location $C0.
>BR END     Set breakpoint at address of symbol END.
>PC *      Set program counter at address pointed to
           by cursor.
```

Use the *Type* options in the *Add Variable* dialog to choose a variable type: 8-bit bytes, 16-bit words, 32-bit longs, or ASCII strings.

- **Delete Variable:** Choose this option to remove the selected (highlighted) variable from memory and from the current variable list.
- **Clear All:** Choose this option to clear all variables in the current variable list.

6.6.3 Variable Window Keyboard Commands

Use these keys to navigate in the Variable Window:

- Press the Insert key to add a variable.
- Press the Delete key to delete a variable.
- Press the Up Arrow (↑) key to scroll the Variable Window up one variable.
- Press the Down Arrow (↓) to scroll the Variable Window down one variable.

- Press the Home key to scroll the Variable Window to the first variable.
- Press the End key to scroll the Variable Window to the last variable.
- Press the Page Up key to scroll the Variable Window up one page.
- Press the Page Down key to scroll the Variable Window down one page.
- Press the F1 key to shows the Help Contents topics.
- Press the Escape (Esc) key to move the cursor to the command line of the Status Window.

6.7 MEMORY WINDOW

Use the Memory Window (Figure 6-8) to view and modify the memory in the ICS05CW. View bytes by using the scrollbar on the right side of the window.

To modify a set of bytes:

1. Double click on the bytes to open the *Modify Memory* dialog for that address.
2. Enter the MM command in the command line of the Status Window.

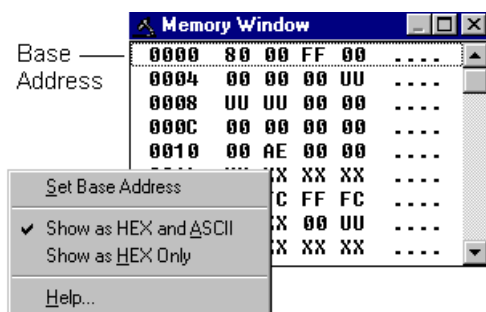

Figure 6-8. Memory Window with Shortcut Menu

Use the options from the Memory Window Shortcut menu to perform these memory functions:

- **Set Base Address:** Choose this option to set the first memory address to display in the Memory window.
- **Show as HEX and ASCII:** Choose this option to display memory map information in both HEX and ASCII formats.
- **Show as HEX Only:** Choose this option to display memory map information in HEX format only, allowing more bytes per row.

Use these keys to navigate in the Memory Window:

- Press the Up Arrow (↑) to scroll the Memory Window up one line.

- Press the Down Arrow (↓) to scroll the Memory Window down one line.
- Press the Home key to scroll the Memory Window to memory address \$0000.
- Press the End key to scroll the Memory Window to the last address in the memory map.
- Press the Page Up key to scroll the Memory Window up one page.
- Press the Page Down key to scroll the Memory Window down one page.
- Press the F1 key to show the Help Contents topic.
- Press the Escape (Esc) key to move the cursor to the command line of the Status Window.

6.8 STATUS WINDOW

The Status Window (Figure 6-9) accepts ICS05CW commands entered on the command line, executes them, and returns an error message or status update message, as in the message area of the window.

The Status Window message area displays all ICS05CW commands (including implemented ICS05CW menu options and toolbar buttons), and command results.

Use the scroll controls on the right side of the Status Window to view previous commands or use these keys to navigate within the message area:

- Press the up arrow (↑) key to scroll the window up one line
- Press the down arrow (↓) key to scroll the window down one line.
- Press the Home key to scroll the window to the first status line.
- Press the End key to scroll the window to the last status line.
- Press the Page Up key to scroll the window up one page.
- Press the Page Down key to scroll the window down one page.
- Press the F1 key to display the Help Contents topic.

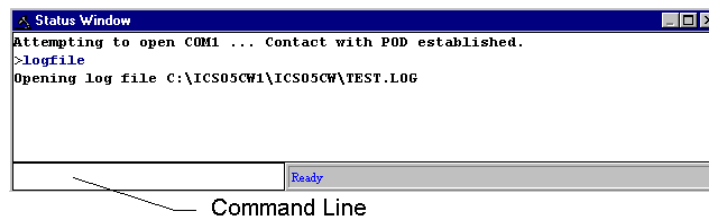

Figure 6-9. Status Window

To save the information displayed in the Status Window, enable logging:

- Choose the Start Logfile option from the ICS05CW File menu, or enter the LF command in the Status Window command line (Figure 6-10).

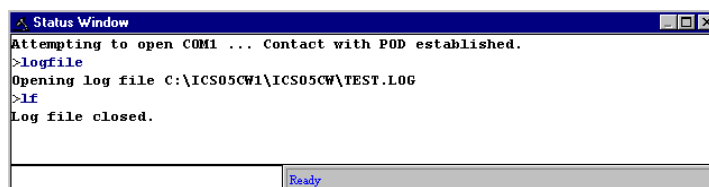

Figure 6-10. Results of Entering the LF Command in the Status Window

- The *Specify output LOG file* dialog (Figure 6-11) opens.

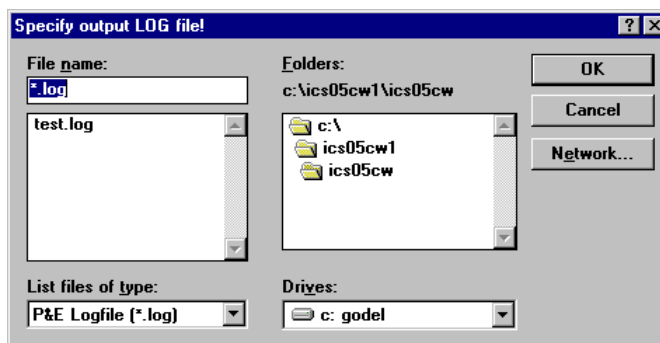

Figure 6-11. Specify Output LOG File! Dialog

- In the dialog, choose a path and filename for the logfile. Press OK to create the file (or Cancel to close the dialog without making changes).
- If you choose a logfile that already exists, the *Logfile Already Exists* message (Figure 6-12) appears, asking if you wish to overwrite the existing file or append the status messages to the end of the existing file. Choose Overwrite or Append to begin logging in the file or Cancel to close the dialog without opening the logfile.

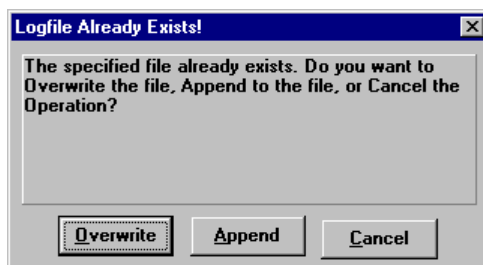

Figure 6-12. The Logfile Already Exists Message

- Status window messages are added to the logfile while logging is enabled.

To end logging, choose the End Logfile option from the ICS05CW File menu or enter the LF command in the ICS05CW Status window command line.

6.9 CPU WINDOW

The CPU Window displays the current register values.

6.9.1 Changing Register Values

Use the CPU Window (Figure 6-13) or its Shortcut Menu options to view and modify the current state of registers within the CPU.

- To change CPU register values using the Shortcut menu options, position the cursor in the CPU window and click the right mouse button. Choose the option from the shortcut menu shown on the right of Figure 6-13. Enter the new value in the dialog and press OK to close the dialog and save the new value.

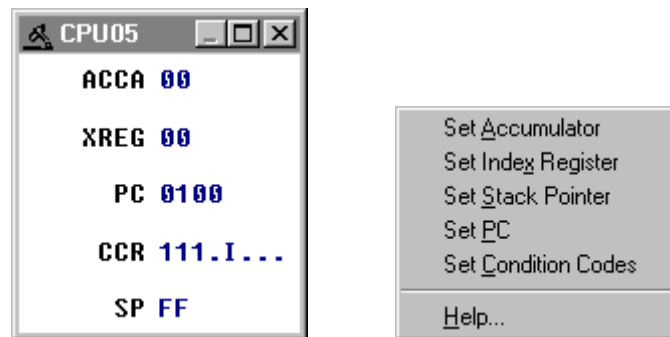

Figure 6-13. CPU Window with Shortcut Menu

- To change CPU register value in the CPU window:
 - To change the CPU accumulator (ACCA), index register (XREG), and program counter (PC) values from the CPU window, click on the value and enter the new value in the dialog. Press OK to close the dialog and save the new value.

- To change the CPU CCR values, double click the CCR value in the CPU window to open the *Change CCR* dialog (Figure 6-14). Change the H, I, N, Z, or C CCR bits by pressing the button below each to toggle condition code register bits between 1 (on) and 2 (off). Press OK to close the dialog and save the values.



Figure 6-14. The *Change CCR* Dialog

- To change the CPU stack pointer (SP) value from the CPU window, position the cursor in the CPU window and click the right mouse button to open the CPU shortcut menu. Choose the *Set Stack Pointer* option. In the *Change SP Value* dialog, enter the new value. Press OK to close the dialog and save the value.

NOTE

In the current version of the ICS05CW software, the values in the CPU window behave differently when clicked. You can open the appropriate dialog by clicking once on the ACCA and XREG values and by clicking twice on the PC and CCR values. To change the SP value, use the shortcut menu.

6.9.2 CPU Window Keyboard Commands

Use these keyboard commands to navigate in the CPU Window:

- Press the F1 key to shows the Help Contents topics.
- Press the Escape (Esc) key to move the cursor to the command line of the Status Window.

6.10 CHIP WINDOW

6.10.1 Reading Values in the Chip Window

Use the Chip Window (Figure 6-15) to see a visual representation of the logic levels at all pins of the chip.

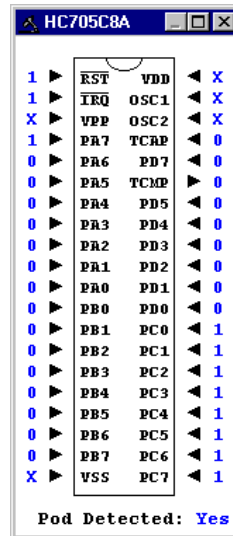

Figure 6-15. Chip Window

If the ICS05CW pod is connected to the software, the Chip Window reflects the values read from the pod. For I/O pins, the arrows indicate whether the pin is an input or an output.

6.10.2 Chip Window Keyboard Commands

Use these keyboard commands to navigate in the Chip Window:

- Press the F1 key to show the Help Contents topics.
- Press the Escape (Esc) key to move the cursor to the command line of the Status Window.

6.11 CYCLES WINDOW

Use the Cycles Window (Figure 6-16) to view the number of processor cycles that passed during execution of code in the simulator. This is valuable if you want to count the number of cycles that a section of code requires. In order to calculate the timing of code for a device, take the number of cycles shown in the window and multiply by the amount of time that a cycle represents in the target system. (i.e. for a 2MHz HC05, the time per cycle is 500 ns ($\frac{1}{2}\mu\text{sec.}$)



Figure 6-16. Cycles Window

6.12 STACK WINDOW

Use the Stack window (Figure 6-17) to view:

- Values that have been pushed on the stack
- The stack pointer value
- CPU results if a RTI or RTS instruction is executed at that time.

To display the stack window, enter the `STACK` command in the ICS05CW Status Window command line.

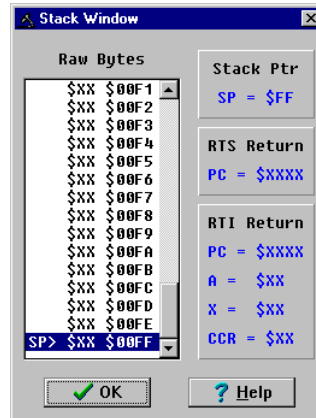

Figure 6-17. Stack Window

6.12.1 Interrupt Stack

During an interrupt, the Stack window displays:

- The interrupt stack
- Data values in the stack
- Values of the condition code register (CCR), accumulator (A) and index register (X).

This information indicates the restored state of the stack upon the return from the interrupt.

6.12.2 Subroutine Stack

During execution of a subroutine, the stack window displays the subroutine stack that indicates the restored state of the CPU upon return from a subroutine.

NOTE

M68HC05 MCUs store information in the stack (1) during an interrupt or (2) during execution of a subroutine. The stack window shows both these possible interpretations of stack data. It is important to know whether program execution is in an interrupt or in a subroutine, to know which stack data interpretation is valid.

6.13 TRACE WINDOW

Use the Trace Window (Figure 6-18) to view instructions captured while tracing is enabled.

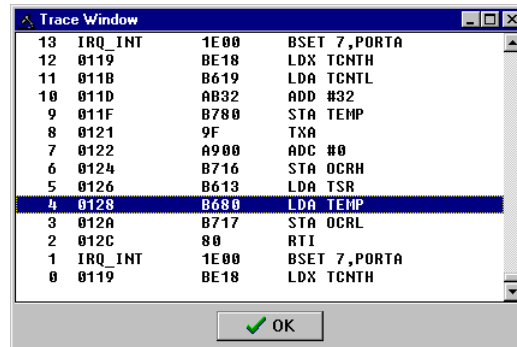

Figure 6-18. Trace Window

To display the Trace Window, enter the SHOWTRACE command in the command line of the ICS05CW Status Window.

To enable or disable tracing, enter the TRACE command. If tracing is off, the command will toggle tracing on; if tracing is on, the command toggles tracing off.

The trace buffer is a 1024 instruction circular buffer that contains all addresses that have been executed. When the trace window displays instructions, it disassembles instructions at the addresses stored in the trace buffer. For this reason, the tracing function cannot be used for self-modifying code. If a buffer slot does not have an address stored in it, the trace window displays the phrase "No Trace Available". The number in the beginning of a trace line is the slot number in the trace buffer. The slot number is an offset for the instruction in that slot compared to the current instruction executing (slot number=0).

6.14 BREAKPOINT WINDOW

Use the Breakpoint Window (Figure 6-19) to view all breakpoints currently set in the current debugging session, and to add, modify, or delete breakpoints. You can set a maximum of 64 breakpoints.

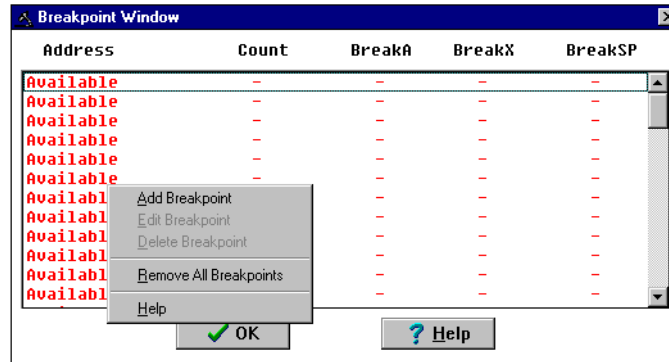

Figure 6-19. Breakpoint Window with Shortcut Menu

To display the Breakpoint Window, enter the SHOWBREAKS command in the ICS05CW Status Window command-line.

If a breakpoint slot is empty, the word 'Available' appears under the Address column.

6.14.1 Adding a Breakpoint

To add a breakpoint, with the cursor in the Breakpoint Window, click the right mouse button to open the Breakpoint Shortcut Menu. Select the *Add Breakpoint* option from the Shortcut Menu. In the *Edit Breakpoint* dialog (Figure 6-20), enter the address for the new breakpoint in the *Address* text box. Press the OK button to close the dialog and save the new breakpoint.

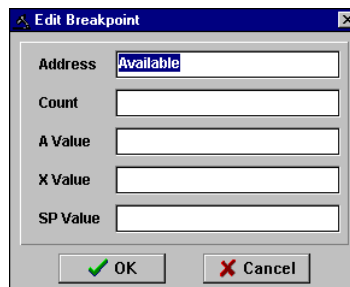

Figure 6-20. Edit Breakpoint Dialog

You may qualify the breakpoint using these qualifiers:

- **Count:** Enter the number of times the address will be reached before breaking, i.e., break after n times (the default is $n=1$).
- **Accumulator value:** Enter the number the accumulator value must reach before breaking, i.e., break if address and $A=n$.
- **X index register value:** Enter the number the index register value must reach before breaking, i.e., break if address and $X=n$.
- **Stack Pointer value:** Enter the number the stack pointer value must reach before breaking, i.e., break if address and $SP=n$.

6.14.2 Editing a Breakpoint

To edit a breakpoint or view address information, double click on any empty breakpoint slot in the Breakpoint Window listbox. The *Edit Breakpoint* dialog (Figure 6-20) displays address information for the empty breakpoint slot. Enter the appropriate address and other conditional qualifiers and press the OK button to exit.

In the Breakpoint Window, select the breakpoint to edit. Then use one of the following methods to open the Breakpoint Shortcut menu and edit the breakpoint:

- Click the right mouse button to open the Breakpoint Shortcut Menu and select the Edit Breakpoint menu option.
- Press the Insert key.
- Double click on the breakpoint in the listbox. In the *Edit Breakpoint* dialog, enter the new breakpoint address and conditional qualifiers. Press the OK button to close the dialog and store the new settings (or press the Cancel button to close the dialog without saving new settings).

6.14.3 Deleting a Breakpoint

In the Breakpoint Window, choose the breakpoint to delete, and use one of the following methods to delete the breakpoint:

- Click the right mouse button to open the Breakpoint Shortcut Menu and select the Delete Breakpoint menu option.
- Press the Delete key, to remove the selected breakpoint from the breakpoint list.

Press the OK button to close the Breakpoint Window and store the changes (or press Cancel to close the window without saving the changes).

6.14.4 Removing All Breakpoints

In the Breakpoint Window, click the right mouse button to open the Breakpoint Shortcut Menu. Choose the Remove All Breakpoints menu option to clear all breakpoints. Press the OK button to store changes and close the Breakpoint Window (or press the Cancel button to close the Breakpoint Window without saving changes).

6.15 PROGRAMMER WINDOWS

Use the Programmer Windows to enter or display programming information and to choose the files to upload or download.

Programming software in the PC controls the M68ICS05C pod programming socket (U2), and sends RESET, CLOCK, DATA, and other control signals to the pod by means of the serial connection.

During programming, you may use three Programming Windows:

- **Pick Window:** The Pick Window (Figure 6-21) displays all programming actions and functions for you to select.

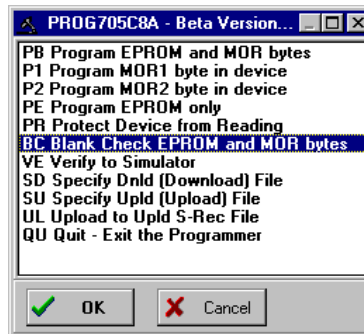

Figure 6-21. PROG05C Programmer Pick Window

- **Status Window:** The Programmer Status Window accepts programming commands on the command line or from the Pick Window and displays the command results in the message area. It is identical in form and function to the ICS05CW Status Window.

- **Files Window:** The Programmer Files window (Figure 6-22) identifies the filename of the download and upload files.

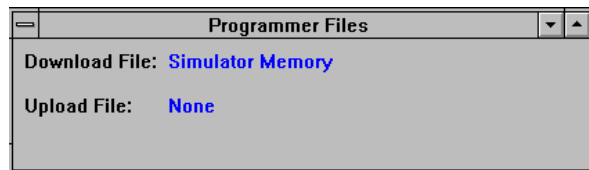

Figure 6-22. Programmer Files Window

For more information about using the Programmer windows, see the PROGRAM command explanation in Chapter 7.

6.16 REGISTER BLOCK WINDOW

The Register Block Window (Figure 6-23) can be opened by pressing the Register Files button on the ICS05CW toolbar or by entering the R command in the Status Window command line.



Figure 6-23. The Register Block Window

The R command loads the register interpreter and opens the Register Files window. From this window, you can establish the WinReg (Figure 6-24) and Register Window text, colors, and window positions and view the processor's register files (sold separately by P&E Microcomputer Systems).

If you have added register files to your host computer, you can select a file from the list of register files to display the addresses and address descriptions for each and to begin the interactive setup of system registers (for example, the I/O, timer, and COP Watchdog Timer).

You can view the registers, modify values, and store results in memory.

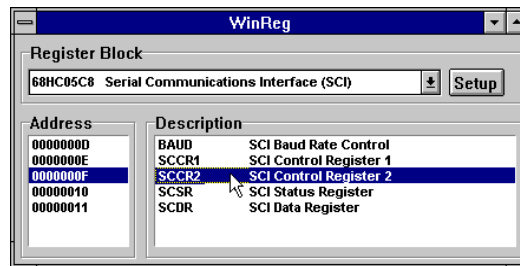

Figure 6-24. The WinReg Window with Typical Register File Information

6.17 ENTERING DEBUGGING COMMANDS

To enter commands in the ICS05CW Status window command line:

1. Type the command and its options and/or arguments in the text area (the command line).
2. When the command is complete, press the Enter key to execute the command.
3. If the command has not been entered correctly, the Status window will display a message such as *Invalid command or parameter*. If the command has been entered correctly, other prompts, messages, or data appropriate to the command entered are displayed in the Status window text area.
4. After the command has been executed, a new blank line appears in the command line.
5. The ICS05CW maintains a command buffer containing the commands and system responses to the commands entered on the command line. You can use the mouse or keyboard commands to sequence forward or backward through the command buffer.

For more instructions on using the ICS05CW command set, see Chapter 7, The ICS05CW Command Set.

6.18 ICS05CW TOOLBAR













The ICS05CW Toolbar (Figure 6-25) provides a number of convenient shortcut buttons that duplicate the function of the most frequently used menu options. A tool-tip or label pops up when the mouse button lingers over a toolbar button, identifying the button's function.



Figure 6-25. WinIDE Toolbar

Table 6-2 identifies and describes the WinIDE toolbar buttons.

Table 6-2. ICS05CW Toolbar Buttons

Icon	Button Label	Button Function
	Back to Editor	Return to the WinIDE editor.
	Load S19 File	Open the <i>Specify S19 File to Load</i> dialog to choose an S19 file.
	Reload Current S19	Reload the last (most currently loaded) S19 file.
	Reset	Simulate a reset of the MCU and sets the program counter (PC) to the contents of the reset vector (does not start execution of user code).
	Step	Execute the STEP command.
	Multiple Step	Execute the STEPFOR command.
	Go	Execute the GO command.
	Stop	Stop execution of assembly commands.
	Play Macro	Open the <i>Specify Macro File to Execute</i> dialog to choose a macro to execute.
	Record Macro	Open the <i>Specify Macro File to Record</i> dialog to enter a filename for the macro.
	Stop Macro Function	Stop recording the macro.
	Open Logfile	Execute the LOGFILE command. Opens the <i>Specify Output Logfile</i> dialog.
	Close Logfile	Execute the LOGFILE command; closes the current logfile.

6.19 ICS05CW MENUS

Table 6-3 summarizes WinIDE menu titles and options.

Table 6-3. ICS05CW Menus and Options Summary

Menu	Option	Description
File	Load S19 File	Open the <i>Specify S19 File to Open</i> dialog to choose S19 file.
	Reload Last S19	Reload the last S19 file used, or (if none loaded) display the <i>Specify S19 File to Open</i> dialog.
	Play Macro	Open the <i>Specify Macro File to Execute</i> dialog.
	Record Macro	Open the <i>Save As</i> dialog.
	Stop Macro	Close the macro or script file.
	Open Logfile	Executes the LOGFILE command.
	Close Logfile	Executes the LOGFILE command.
	Exit	Close the ICS05CW simulator.
Execute	Reset Processor	Reset the emulation MCU and program counter to the contents of the reset vector.
	Step	Execute the STEP command.
	Multiple Step	Execute the STEPFOR command.
	Go	Execute the GO command.
	Stop	Stop code execution.
	Repeat Command	Repeat the last command entered in the Status Window command line.

Table 6-3. ICS05CW Menus and Options Summary (continued)

Menu	Option	Description
Windows	Code 1	Toggles the Code 1 Window open/closed.
	Code 2	Toggles the Code 2 Window open/closed.
	Memory	Toggles the Memory Window open/closed.
	Variables	Toggles the Variables Window open/closed.
	Cycles	Toggles the Cycles Window open/closed.
	Status	Toggles the Status Window open/closed.
	CPU	Toggles the CPU Window open/closed.
	Chip	Toggles the Chip Window open/closed.
	Change Colors	Opens the <i>Changes Windows Colors</i> dialog.
	Reload Desktop	Executes the LOADDESK command to load the desktop settings from a file.
Save Desktop	Executes the SAVEDESK command to save the current desktop settings to a file.	

6.20 FILE OPTIONS

Use the ICS05CW File menu options to load, reload, open, or close files, play or record macros, or exit the ICS05CW application.

To perform a File operation, click once on the File menu (Figure 6-26) title to open the menu. Click on the option to execute.

Load S19 File	F2
Reload Last S19	F3
Play Macro	Ctrl+P
Record Macro	Ctrl+M
Stop Macro	Ctrl+S
Open Logfile	Ctrl+L
Close Logfile	Ctrl+C
Exit	Ctrl+X

Figure 6-26. File Menu

The following topics describe and explain the ICS05CW File operations and dialogs.

6.20.1 Load S19 File

Select the **Load S19 File** option from the File menu to open the *Specify S19 File to Load* dialog (Figure 6-27). If the S19 file is not in the default directory, choose a filename and drive/directory, and network path of an object file or source file to load in the Debugger main window. You can also use this option to load SLD Map files.

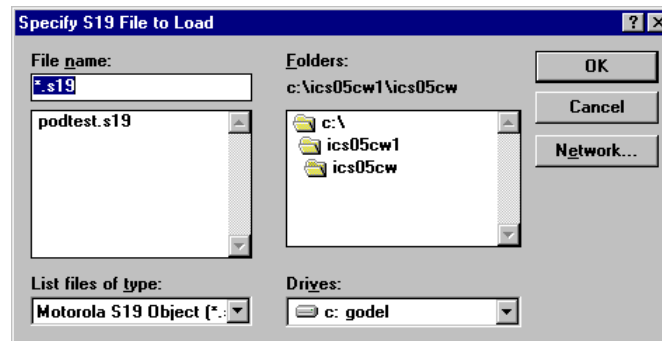

Figure 6-27. Specify S19 File to Load Dialog

To load an S19 or .MAP file, choose the **Load S19 File** option from the File menu to open the *Specify S19 File to Load* dialog. Choose the path and filename and press OK to open the selected file in the ICS05CW (or press Cancel to close the dialog without making a selection).

Alternatives: Press the **F2** function key or click the **Load S19 File** toolbar button, or enter the LOAD command and filename and other arguments in the Status window command line.

6.20.2 Reload Last S19

Select the **Reload Last S19** option from the File menu to open the *Specify S19 File to Load* dialog (Figure 6-27) and select the most recently opened S19 or .MAP file to open in the Debugger main window. Follow the procedure for loading an S19 file (above).

Alternatives: Press the **F3** function key or click the **Reload Current S19** toolbar button. These are the keyboard equivalents to choosing the **File - Reload Last S19** menu option.

6.20.3 Play Macro

Select the **Play Macro** option from the File menu to open the *Specify MACRO File to Execute* dialog (Figure 6-28) to specify a macro filename and drive/directory path to play.

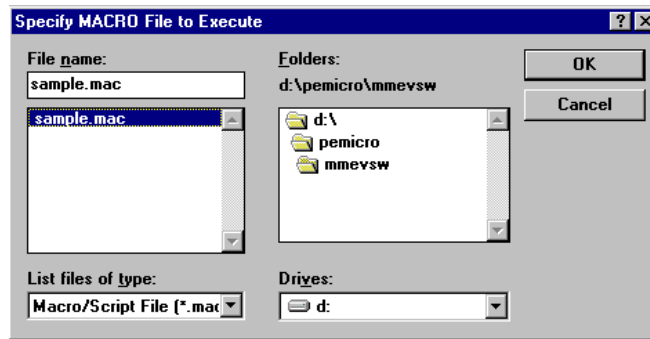

Figure 6-28. *Specify MACRO File to Execute* Dialog

Alternatives: Press the **Ctrl + P** key combination or click the **Play Macro** toolbar button. These are the keyboard equivalents to choosing the **File - Play Macro** menu option.

6.20.4 Record Macro

Select the **Record Macro** option from the File menu to open the *Specify MACRO File to Record* dialog (Figure 6-29) and specify a macro filename and drive/directory path to record.



Figure 6-29. *Specify MACRO File to Record* Dialog

After the macro file has been chosen, all keyboard commands entered in the Debugger window will be recorded in the macro file and can be repeated by playing “back” the macro using the **File - Play Macro** menu option.

Alternatives: Press the **Ctrl + M** key combination or click the **Record Macro** toolbar button. These are the keyboard equivalents to choosing the **File - Record Macro** menu option.

6.20.5 Stop Macro

Select the **Stop Macro** option from the File menu (or press the Ctrl + S key combination) to stop the active macro's execution.

Alternatives: Press the **Ctrl + S** key combination or click the **Stop Macro** toolbar button. These are the keyboard equivalents to choosing the **File - Stop Macro** menu option.

6.20.6 Open Logfile

Select the **Open Logfile** option from the File menu to open the *Specify Output LOG File* dialog (Figure 6-30). Use this dialog to specify a log filename and directory/drive path in which to save output log information for the current debugging session.

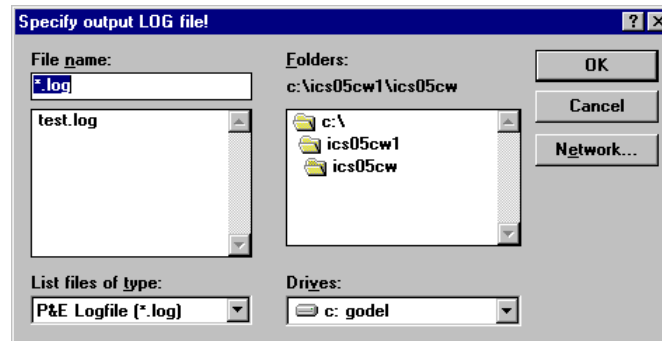

Figure 6-30. Specify Output LOG File Dialog

If the specified log file exists, a message box (Figure 6-31) prompts you to:

- Overwrite the existing logfile with current logging information
- Append the current logging information at the end of the existing logfile
- Cancel the Open Logfile command without saving logging information

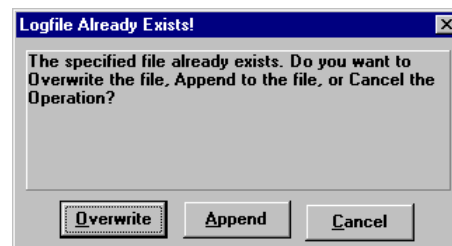



Figure 6-31. Logfile Already Exists Dialog

The open log file does not appear in the Debugger window. To enable logging in a currently active logfile, you must execute the **LF** (Log File) command as well, otherwise no logging occurs in the open log file.

The **LF** command begins logging of commands and responses to the specified external. While logging is enabled, any line appended to the command log window is also written to the log file (Figure 6-32). Logging to the external file continues until another **LF** command stops logging and closes the log file.



```
D:\PEMICRO\LOG\SAMPLE.LOG
Opening log file D:\PEMICRO\LOG\SAMPLE.LOG
>Logfile
Appending to log file D:\PEMICRO\LOG\SAMPLE.LOG
>LF
pReset
>Osc
>Baud
>Step
>Stepfor
Operator interrupt.
>Stepfor
```

Figure 6-32. A Sample Output Log File

You may view the logfile in the WinIDE editor or in any program that displays text files.

Alternatives: Press the **Ctrl + L** key combination or click the **Open Logfile** toolbar button. These are the keyboard equivalents to choosing the **File - Open Logfile** menu option.

6.20.7 Close Logfile

Choose **Close Logfile** from the File menu to stop logging and close the active logfile.

Alternatives: Type **Ctrl + C** or click the Close Logfile button on the toolbar, or enter the **LF** command in the Status window command line. These are the keyboard equivalents to choosing the **File - Close Logfile** menu option.

6.20.8 Exit

Choose **Exit** from the File menu to close the Debugger application.

Alternative: Type **Ctrl + X** to exit the Debugger application and close the subordinate and main windows. This is the keyboard equivalent to choosing the **File - Exit** menu option.

6.21 ICS05CW EXECUTE OPTIONS

Use the ICS05CW Execute menu options to reset the emulation microcontroller and perform debugger routines.

To perform an Execute operation, select Execute in the Menu bar to open the Execute menu (Figure 6-33). Click on an option to perform the operation.

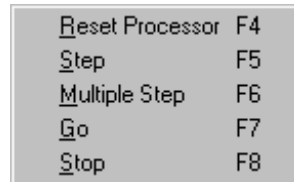

Figure 6-33. ICS05CW Execute Menu

6.21.1 Reset Processor

Choose **Reset Processor** from the Execute menu to send the RESET command to the emulation MCU and reset the program counter (PC) to the contents of the reset vector.

Alternative: Press the **F4** function key. This is the keyboard equivalent of the **Execute - Reset Processor** menu option.

6.21.2 Step

Choose **Step** from the Execute menu to send the Single Step (Trace) command to the MCU. The Step command executes a single instruction, beginning at the current program counter (PC) address value.

NOTE

The Step command does not execute instructions in real-time, so timer values cannot be tested using this command.

Alternative: Press the **F5** function key. This is the keyboard equivalent to choosing the **Execute - Step** menu option.

6.21.3 Multiple Step

Choose **Multiple Step** from the Execute menu to send the STEPFOR command to the MCU. The STEPFOR command begins continuous instruction execution, beginning at the current program counter (PC) address value, and continuing until any key is pressed.

NOTE

The **Multiple Step** command does not execute instructions in real-time, so timer values cannot be tested using this command.

Alternative: Press the **F6** function key. This is the keyboard equivalent to choosing the **Execute - Multiple Step** menu option.

6.21.4 Go

Choose **Go** from the Execute menu to start execution of code in the ICS05CW at the current address. Code execution continues until a stop command is entered, a breakpoint is reached, or an error occurs.

Alternative: Press the **F7** function key. This is the keyboard equivalent to choosing the **Execute - Go** menu option.

6.21.5 Stop

Choose **Stop** from the Execute menu to stop program execution and update the ICS05CW simulator windows with current data.

Alternative: Press the **F8** function key. This is the keyboard equivalent to choosing the **Execute - Stop** menu option.

6.21.6 Repeat Command

Choose **Repeat Command** from the Execute menu to repeat the execution of the last command entered in the Status Window command line.

Alternative: Press the **F9** function key. This is the keyboard equivalent to choosing the **Execute - Repeat Command** menu option.

6.22 ICS05CW WINDOW OPTIONS

Use the Window menu options to change the window displays in the ICS05CW simulator.

To make changes to the windows, select Window in the Menu bar to open the Window Menu (Figure 6-34). Click on an option to perform the operation.

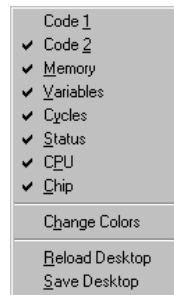

Figure 6-34. Window Menu

6.22.1 Open Windows

The Window menu options itemize the source file windows that can be opened in the ICS05CW. A check beside the window name toggles that window display to *on*. Uncheck the window name to close the window; check the window name to open it.

For example, Figure 6-35 indicates that all ICS05CW windows are open except Code 1. To open the Code 1 window, click on the Code 1 option. To close the Chip Window, click on the Chip option to remove the check and close the window.

6.22.2 Change Colors

Choose **Change Colors** from the Windows menu to open the *Change Window Colors* Dialog (Figure 6-35).

The *Change Window Colors* dialog displays the color settings for the ICS05CW debugger windows or window components. To see the current settings, select the window or window element from the list on the left. To change the foreground or background color setting for this window or element, uncheck the Use Defaults for Foreground/Background checkbox, and use the left mouse button to select a foreground color, or use the right mouse button to select a background color. Press the OK button to save the color changes (or press the Cancel button to close the dialog without saving changes).

Some window items allow only the foreground or background to be changed.

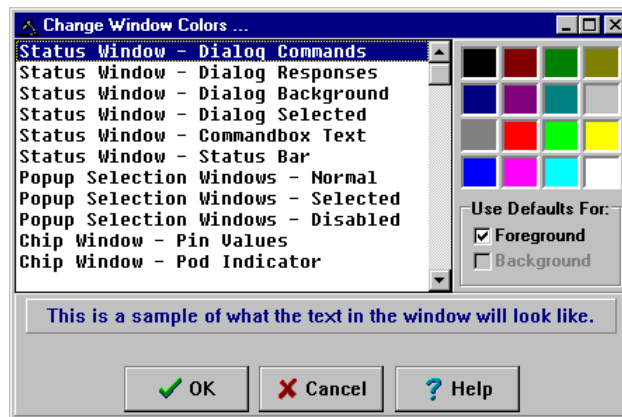

Figure 6-35. Change Window Colors Dialog

6.22.3 Reload Desktop

Choose **Reload Desktop** from the Windows menu to reload the stored configuration for the current project.

This option is useful for restoring desktop window to their stored sizes and locations after making changes. To make changes permanent, choose the Save Desktop option. The new window sizes and locations will be written over the old settings, and stored with other project files.

6.22.4 Save Desktop

Choose **Save Desktop** from the Windows menu to save the current configuration of the desktop, the position and size of the windows in the ICS05CW simulator.

CHAPTER 7

ICS05CW DEBUGGING COMMAND SET

7.1 OVERVIEW

This chapter consists of:

- A logical overview of the ICS05CW debugging command set
- An explanation of rules for using the command set, including command syntax and arguments
- A summary of commands by type and function
- Detailed descriptions of the commands, with example usage

The ICS05CW simulator command set consists of commands for simulating, debugging, analyzing, and programming microcontroller programs. Use the commands to:

- Initialize emulation memory
- Display and store data
- Debug user code
- Control the flow of code execution

7.2 ICS05CW COMMAND SYNTAX

A command is a line of ASCII text that you enter from the computer keyboard. For ICS05CW debugging commands, enter the command and its arguments in the ICS05CW Status window command line. Press Enter to terminate each line and activate the command. The typical command syntax is:

```
command [<argument>]...
```

Where:

command	A command name, in upper- or lower-case letters.
<i><argument></i>	An argument indicator; when arguments are italicized, they represent a placeholder for the actual value you enter; when not italicized, they indicate the actual value to enter. Table 7-1 explains the possible argument values.

In command syntax descriptions:

[]	brackets enclose optional items,
	a vertical line means <i>or</i> ,
...	an ellipsis means that you can repeat the preceding item,
()	parentheses enclose items only for syntactical purposes

Except where otherwise noted, numerical values in debugging command examples are hexadecimal.

7.3 COMMAND-SET SUMMARY

Table 7-1 lists the argument types used for commands. Table 7-2 lists the commands alphabetically and summarizes their functions.

7.3.1 Argument Types

Table 7-1. Argument Types

Type	Syntax Indicators	Explanation
Numeric	<n>, <rate>, <data>, <signal>, <frame>, <frequency>, <clips>, <count>, <value>	Hexadecimal values, unless otherwise noted. For decimal values, use the prefix ! or the suffix T. For binary values, use the prefix % or the suffix Q. Example: 64 = !100 = 100T = %1100100 = 1100100Q.
Address	<address>	Four or fewer hexadecimal digits, with leading zeros when appropriate. If an address is decimal or binary, use a prefix or suffix, per the explanation of numeric arguments.
Range	<range>	A range of addresses or numbers. Specify the low value, then the high value, separated by a space. Use leading zeros if appropriate.
Symbol	<symbol>, <label>	Symbols of ASCII characters, usually symbols from source code.
Filename	<filename>	The name of a file, in DOS format: eight or fewer ASCII characters. You may include an optional extension (three or fewer characters) after a period. If the file is not in the current directory, precede the name with one or more directory names.
Keyword	Capital letters, such as CLIPS	A word to be entered as shown, although optionally in lower case.
	<type>, <state>, <id>, <mcuid>, <tag>, <signal>, <mode>, <v>	Sets of keywords: enter one of the set for a command.
Operator	<op>	+ (add); - (subtract); * (multiply); or / (divide)

7.3.2 Command Summary

Table 7-2. ICS05CW Command Overview

Command	Description
A	Set the accumulator to specified value and display new value in CPU Window. (Identical to the ACC command.)
ACC	Set the accumulator to specified value and display new value in CPU Window. (Identical to the A command.)
ASM	Assemble M68HC05 instruction mnemonics and place resulting machine code in memory at the specified address.
BELL	Sound PC bell the specified number of times.
BF	Fill a block of memory with a specified byte, word, or long value.
BR	Display or set instruction breakpoint to specified values or at cursor location.
BREAKA	Set accumulator breakpoint to halt code execution when the accumulator value equals the specified value.
BREAKSP	Set stack pointer breakpoint to halt code execution when the SP equals the specified value.
BREAKX	Set index breakpoint to halt code execution when the X or Index register equals the specified value.
C	Set or clear the C bit of the CCR.
CAPTURE	Specify location to be monitored for changes in value.
CAPTUREFILE	Open a capture file to record changed values. (Identical to the CF command.)
CCR	Set the CCR in the CPU to the specified hexadecimal value.
CF	Open a capture file to record changed values. Identical to the CAPTUREFILE command.
CHIPMODE	Set chip for simulation
CLEARMAP	Remove the current MAP file from memory.
CLEARSYMBOL	Remove all user-defined symbols from memory.
COLORS	Set simulator colors
CY	Change the value of the cycles counter.
CYCLES	Change the value of the cycles counter.

Table 7-2. ICS05CW Command Overview (continued)

Command	Description
DASM	Disassemble machine instructions, display addresses and contents as disassembled instructions in the Code Window.
DDRA	Assign the specified byte value to the Port A data direction register (DDRA).
DDRB	Assign the specified byte value to the Port B data direction register (DDRB).
DUMP	Send contents of a block of memory to the Status Window in bytes, words or longs.
EVAL	Evaluate a numerical term or expression and give the result in hexadecimal, decimal, octal, and binary format.
EXIT	Terminate the software and close all windows. (Identical to QUIT.)
G	Start execution of code at the current PC address or at an optional specified address. (Identical to the GO and RUN commands.)
GO	Start execution of code at the current PC address or at an optional specified address. (Identical to the G and RUN commands.)
GOMACRO	Execute the program in the simulator beginning at the address in the PC and continue until a keypress, Stop Macro command (from the Toolbar), breakpoint, or error occurs.
GOTIL	Execute code beginning at the PC address and continue until the PC contains the specified ending address or until a keypress, Stop Macro command (from the Toolbar), breakpoint, or error occurs.
GOTOCYCLE	Execute code beginning at the current PC and continue until the cycle counter is equal to or greater than the value specified.
H	Set or clear the H bit in the CCR.
HELP	Open the ICS05CW Help File
I	Set or clear the I bit of the CCR.
INFO	Display information about the line highlighted in the source window.
INPUTA	Set the simulated inputs to Port A.
INPUTB	Set the simulated inputs to Port B.
INPUTS	Show the simulated input values to Port A and B.
INT	View or assign the state value of the MCU IRQ pin. (Identical to the IRQ command.)

Table 7-2. ICS05CW Command Overview (continued)

Command	Description
IRQ	View or assign the state value of the MCU IRQ pin. (Identical to the INT command.)
LF	Open a new or specified external file to receive log entries of commands and responses in the Status Window. (Identical to the LOGFILE command.)
LISTOFF	Turn off screen listing of stepping information.
LISTON	Turn on screen listing of stepping information.
LOAD	Load S19 object file and associated MAP file into the ICS05CW.
LOADDESK	Load the desktop settings for window positions, size, and visibility.
LOADMAP	Load a MAP file containing source level debug information into the ICS05CW.
LOGFILE	Open a new or specify an existing external file to receive log entries of commands and responses from the Status Window. (Identical to the LF command.)
MACRO	Execute a macro file containing debug command sequences.
MACROEND	Close the macro file in which the debug command sequences are being saved.
MACROSTART	Open a macro file and save all subsequent debug commands to this file until closed by the MACROEND command during an active ICS05CW session.
MAP	View information from the current MAP file stored in memory. (Identical to the SHOWMAP command.)
MD	Display the contents of memory locations beginning at the specified address in the Memory Window.
MM	Modify contents of memory beginning at the specified address, and/or select bytes, words, longs.
N	Set or clear the N bit of the CCR.
NOBR	Remove one or all of active breakpoints.
NOMAP	Remove the current MAP file from memory, forcing the ICS05CW to show disassembly in the code windows instead of user source code. (Identical to the CLEARMAP command.)
NOSYMBOL	Remove all user-defined symbols from memory; symbols defined in a loaded MAP file are not affected by the NOSYMBOL command.
PC	Assign the specified value to the MCU program counter.

Table 7-2. ICS05CW Command Overview (continued)

Command	Description
POD	Attempt to connect with the ICS05CW circuit board through the specified COM port; when successful, the POD command returns the current status of ports, reset and IRQ pins on the ICS05CW board and the board version number.
PORTA	Assign the specified value to the Port A output register latches. (Identical to the PRTA command.)
PORTB	Assign the specified value to the Port B output register latches. (Identical to the PRTB command.)
PROGRAM	Start the programmer for the desired device.
PRTA	Assign the specified value to the Port A output register latches. (Identical to the PORTA command.)
PRTB	Assign the specified value to the Port B output register latches. (Identical to the PORTB command.)
QUIT	Terminate the ICS05CW application and close all windows. (Identical to the EXIT command.)
R	Open window for Register files (available separately from P&E Microcomputer Systems) and starts interactive setup of system registers such as I/O, time, COP.
REG	Display contents of CPU registers in the Status Window. (Identical to the STATUS command.)
REM	Enter comments in a macro file.
RESET	Simulate a reset of the MCU and sets the PC to the contents of the reset vector. Does not start execution of user code.
RESETGO	Simulates a reset of the MCU, sets PC to contents of the reset vector, and starts execution from the PC address.
RUN	Start execution of code at the current PC current or specified address. (Identical to the G or GO command.)
SAVEDESK	Save the desktop settings for the ICS05CW program when it is first opened or for use with the LOADDESK command.
SCRIPT	Execute a macro file containing debug command sequences. (Identical to the MACRO command.)
SHOW	Display the contents of memory locations in the Memory Window beginning at the specified address. (Identical to the MD command.)

Table 7-2. ICS05CW Command Overview (continued)

Command	Description
SHOWBREAKS	Open window displaying breakpoints used in the current debug session, and allow modifying breakpoints.
SHOWCODE	Display code in the Code Windows beginning at the specified address, but without changing the value of the PC.
SHOWMAP	View current MAP file.
SHOWPC	Display code starting from address in the PC in the Code Window.
SHOWTRACE	Display the Trace Window with the last 1024 instructions executed since the TRACE command issued.
SNAPSHOT	Save window data to the open log file.
SP	Assign specified value to the stack pointer used by the CPU and display in the CPU Window.
SS	Step through a specified number of source code instructions, starting at the current PC address value, then halt.
ST	Step through a specified number of assembly instructions, starting at the current PC address value, then halt. (Identical to the STEP and T commands.)
STACK	Open the HC05 Stack Window showing the stack pointer value, data stored on the stack, and the results of RTS or RTI instruction.
STATUS	Display the contents of the CPU registers in the Status Window. (Identical to the REG command.)
STEP	Step through a specified number of assembly instructions, starting at the current program counter address value, then halt. (Identical to the ST or T commands.)
STEPFOR	Execute instructions continuously, one at a time, starting at the current PC address and continuing until reaching an error condition, breakpoint, or keypress.
STEPTIL	Step through instructions starting at current PC address and continue until PC value reaches the specified address, or until keypress, breakpoint, or error occurs.
SYMBOL	View current or create new symbols.
SYSINFO	Show the amount of system memory available to the ICS05CW and the largest memory block available.

Table 7-2. ICS05CW Command Overview (continued)

Command	Description
T	Step through a specified number of assembly instructions, starting at the current PC address, then halt. (Identical to the ST or STEP commands.)
TRACE	Toggle tracing.
UPLOAD_SREC	Upload the content of the specified memory block (range) in S19 file format and display the contents in the Status Window, and enter information into the current log file.
VAR	Display specified address and contents in the Variables Window for viewing during code execution.
VER	Display version and data of ICS05CW. (Identical to the VERSION command.)
VERSION	Display version and data of ICS05CW. (Identical to the VER command.)
WAIT	Delay simulator command execution by a specified number of cycles.
WHEREIS	Display value of the specified symbol.
X	Set the X register to the specified value and display in the CPU Window. (Identical to the XREG command.)
XREG	Set the X register to the specified value and display in the CPU Window. (Identical to the X command.)
Z	Toggle the Z bit in the CCR.

7.4 COMMAND DESCRIPTIONS

The following sections, which are arranged alphabetically by command name, describe the commands in detail.

A or ACC

Set Accumulator Value

The ACC command sets the accumulator to a specified value. The value entered with the command is shown in the CPU window. The ACC and A commands are identical.

Syntax:

```
ACC <n>
```

where:

<n> The value to be loaded into the accumulator.

Example:

```
A 10                   Set the accumulator to $10.
```

ASM

Assemble Instructions

The ASM command assembles M68HC05-family instruction mnemonics and places the resulting machine code into memory at the specified address. The command displays a window with the specified address (if given) and current instruction, and prompts for a new instruction. Enter the new instruction in the *New Instruction* text box. Press the Enter key to assemble the new instruction, store and display the resulting machine code, then move to the next memory location where you will be prompted for another instruction.

If there is an error in the instruction format, the address stays at the current address and an assembly error flag appears. To exit assembly, press the Exit button.

Syntax:

```
ASM [<address>]
```

where:

<address> Address where machine code is to be generated. If you do not specify an <address> value, the system checks the address used by the previous ASM command, then uses the next address for this ASM command.

Examples:

With an address argument:

```
ASM 100
```

The Assembly Window appears as shown on the left of Figure 7-1; the Assembly Window with the ASM command and no argument is shown on the right).

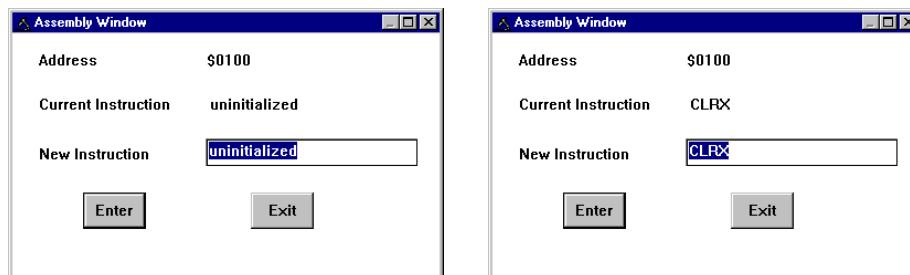

Figure 7-1. Assembly Window — ASM Command with (left), without (right) Argument

BELL

Sound PC Bell

The BELL command sounds the PC bell the specified number of times. If you enter no argument, the bell sounds once. To turn off the bell as it is sounding, press any key.

Syntax:

```
BELL [<n>]
```

where:

<n> The number of times to sound the bell.

Example:

```
BELL 3                    Ring PC bell 3 times.
```

BF

Block Fill Memory

The BF command fills a block of memory with a specified byte, word, or long value. The optional argument specifies whether to fill the block in bytes (.B, the default, 8 bits), in words (.W, 16 bits), or in longs (.L, 32 bits).

Syntax:

```
BF [.B | .W | .L] <startrange> <endrange> <n>
```

where:

<startrange> Beginning address of the memory block (range).
<endrange> Ending address of the memory block (range).
 <n> Byte, word, or long value to be stored in the specified block.

- If the byte variant (.B) is used , then <n> must be a 8-bit value.
- If the word variant (.W) is used , then <n> must be a 16-bit value.
- If the long variant (.L) is used , then <n> must be a 32-bit value.

Examples:

```
BF C0 CF FF            Store FF in bytes at addresses C0-CF.
```

```
BF.W 300 31F 4143      Store word value 4143 at addresses 300-31F.
```

BR

Set Instruction Breakpoint

The BR command displays or sets instruction breakpoints, according to its parameter values:

- If you enter no parameter values, the BR command displays a list of all current breakpoints in the status window.
- If you enter an *<address>* value, the BR command sets a breakpoint at the specified address.

You may also enter an optional value *<n>* with the address to specify a break count. The BR command sets a breakpoint at the specified address, but code execution does not break until the *n*th time it arrives at the breakpoint.

NOTE

The maximum number of breakpoint addresses is 64. Each BR, BREAKA, BREAKSP, or BREAKX command that includes an address value uses an additional breakpoint address, unless the address is a duplicate. For example, if 64 BR commands already have taken up 64 addresses, the only way to include an address value in a BREAKA, BREAKSP, or BREAKX command is to duplicate one of those 64 addresses.

If source code is displayed in either code window, you can set, remove, or clear all breakpoints using mouse or keyboard commands:

1. Position the cursor on the line of code for which you want to set a breakpoint.
2. Press the right mouse button once to open the Code Window Shortcut Menu.
3. Select *Toggle Breakpoint at Cursor* option. If there is no current breakpoint set at this line of code, a breakpoint will be set. If there is a current breakpoint set at this line of code, the breakpoint will be removed.

To remove all breakpoints:

- Enter the NOBR command in the Status Window command line.

BR**(continued)**

Syntax:

```
BR [<address> [<n>]] ;set a breakpoint
BR ;list current breakpoints
```

where:

<address> The address for a breakpoint.

<n> Break after value: code execution passes through the breakpoint *n*-1 times, then breaks the *n*th time it arrives at the breakpoint.

Examples:

```
BR 300 Set a breakpoint at address 300
BR 330 8 Set a breakpoint at address 330, break on eighth arrival at 330.
```

BREAKA

Set Accumulator Breakpoint

The BREAKA command sets an accumulator breakpoint to halt code execution when the value of the accumulator equals the specified *n* value.

- With an *n* value, the command forces a break in execution as soon as the accumulator value equals *n*.
- With *n* and *address* values, the command forces a break in execution when the accumulator value equals *n* and execution arrives at the specified address. (If the accumulator value changes from *n* by the time execution arrives at the address, no break occurs).

NOTE

The maximum number of breakpoint addresses is 64. Each BR, BREAKA, BREAKSP, or BREAKX command that includes an address value uses an additional breakpoint address, unless the address is a duplicate. For example, if 64 BR commands already have taken up 64 addresses, the only way to include an address value in a BREAKA, BREAKSP, or BREAKX command is to duplicate one of those 64 addresses.

If you enter the BREAKA command without an *address* value, the halt in code execution clears the accumulator breakpoint. To cancel the accumulator breakpoint before the halt occurs, enter the BREAKA command without any parameter values. (If you enter the BREAKA command without an *address* value, the accumulator breakpoint does not show in the BREAKPOINT WINDOW.)

If you enter the BREAKA command with an address value, you may clear the accumulator breakpoint by one of these methods:

- Enter the NOBR command
- Position the cursor on that address in the code window, then press the right mouse button, and select Toggle Breakpoint at Cursor menu item.

Syntax:

```
BREAKA [<n> [<address>]]
```

where:

<i><n></i>	Accumulator value that triggers a break in execution.
<i><address></i>	Optional address for the break in execution (provided that the accumulator value equals <i>n</i>).

BREAKA

(continued)

Examples:

BREAKA 55

Break execution when the accumulator value equals 55.

BREAKA

Cancel the accumulator breakpoint.

BREAKA 55 300

Break execution at address 300 if accumulator value equals 55.

BREAKSP

Set Stack Pointer Breakpoint

The BREAKSP command sets a stack pointer breakpoint to halt code execution when the value of the stack pointer equals a specified value.

- With an *n* value, the command forces a break in execution as soon as the stack pointer value equals *n*.
- With *n* and *address* values, the BREAKSP command forces a halt in execution when the stack pointer value equals *n* and execution arrives at the specified address. (If the stack pointer value changes from *n* by the time execution arrives at the address, no break occurs).

NOTE

The maximum number of breakpoint addresses is 64. Each BR, BREAKA, BREAKSP, or BREAKX command that includes an address value uses an additional breakpoint address, unless the address is a duplicate. For example, if 64 BR commands already have taken up 64 addresses, the only way to include an address value in a BREAKA, BREAKSP or BREAKX command is to duplicate one of those 64 addresses.

If you enter the BREAKSP command without an *address* value, the halt in code execution clears the stack pointer breakpoint. To cancel the stack pointer breakpoint before the halt occurs, enter the BREAKSP command without any parameter values. (If you enter the BREAKSP command without an *address* value, the stack pointer breakpoint does not show in the Breakpoint Window.)

If you enter the BREAKSP command with an address value, you may clear the stack pointer breakpoint by one of these methods:

- Enter the NOBR command
- Position the cursor on that address in the code window, then press the right mouse button, and select Toggle Breakpoint at Cursor menu item.

BREAKSP

(continued)

Syntax:

```
BREAKSP [<n> [<address>]]
```

where:

<i><n></i>	Stack pointer value that triggers a break in execution.
<i><address></i>	Optional address for the break in execution (when that the stack pointer value equals <i>n</i>).

Examples:

BREAKSP E0	Break execution when the stack pointer (SP) value equals E0.
BREAKSP	Cancel the SP breakpoint.
BREAKSP E0 300	Break execution at address 300 if SP value equals E0.

BREAKX Set Index Register Breakpoint

The BREAKX command sets an index breakpoint to halt code execution when the value of the index register equals the specified *n* value.

- With an *n* value, the command forces a break in execution as soon as the index register value equals *n*.
- With *n* and *address* values, the command forces a halt in execution when the index register value equals *n* and execution arrives at the specified address. (If the index register value changes from *n* by the time execution arrives at the address, no halt occurs).

NOTE

The maximum number of breakpoint addresses is 64. Each BR, BREAKA, BREAKSP, or BREAKX command that includes an address value uses an additional breakpoint address, unless the address is a duplicate. For example, if 64 BR commands already have taken up 64 addresses, the only way to include an address value in a BREAKA, BREAKSP or BREAKX command is to duplicate one of those 64 addresses.

If you enter the BREAKX command without an *address* value, the halt in code execution clears the index register breakpoint. To cancel the index register breakpoint before the halt occurs, enter the BREAKX command without any parameter values. (If you enter the BREAKX command without an *address* value, the index register breakpoint does not show in the Breakpoint Window.)

If you enter the BREAKX command with an *address* value, you may clear the index register breakpoint using one of these methods:

- Enter the NOBR command
- Position the cursor on that address in the code window, then press the right mouse button, and select Toggle Breakpoint at Cursor menu item.

Syntax:

```
BREAKX [<n> [<address>]]
```

where:

<i><n></i>	Index register value that triggers a break in execution.
<i><address></i>	Optional address for the break in execution (when that the index register value equals <i>n</i>).

BREAKX

(continued)

Examples:

BREAKX A9

Break execution when the index register value equals A9.

BREAKX

Cancel the index breakpoint.

BREAKX A9 300

Break execution at address 300 if index register value equals A9.

C**Set/Clear Carry Bit**

The C command sets or clears the C bit of the condition code register (CCR).

NOTE

The CCR bit designators are in the lower portion of the CPU window. The CCR pattern is 111HINZC (H is half-carry, I is IRQ interrupt mask, N is negative, Z is zero and C is carry). A letter in these designators means that the corresponding bit of the CCR is set; a period means that the corresponding bit is clear.

Syntax:

C 0|1

Examples:

C 0 Clears the C bit of the CCR.

C 1 Sets the C bit of the CCR.

CAPTURE

Capture Changed Data

The CAPTURE command specifies locations to be monitored for changes in value. If the value of such a location changes and if a capture file is open, the file records the change in value. (See the CAPTUREFILE or CF command for more information about capture files).

To stop monitoring a location, specify that same location in another CAPTURE command, or close the capture file. (Closing the capture file undoes the specifications for all monitoring locations).

NOTE

Before you enter the CAPTURE command, open a capture file via the CAPTUREFILE or CF command. The CAPTURE command has no effect unless a capture file is open.

Syntax:

```
CAPTURE <address> [<address>...]
```

where:

<address> Location to be monitored for a change in value.

Examples:

CAPTURE PORTA	Monitor location PORTA for any value changes.
CAPTURE C0	Monitor RAM location C0 for any value changes.
CAPTURE D0 D1 D2	Monitor for any value changes in an array of locations.

CAPTUREFILE or CF

Open/Close Capture File

The CAPTUREFILE command opens a capture file to record changed values. If the specified file does not yet exist, this command creates the file. If the file already exists, you can use an optional parameter to specify whether to overwrite existing contents (R, the default) or to append the log entries (A). If you omit this parameter, a prompt asks for this overwrite/append choice.

The command interpreter does not assume a filename extension for the capture file. To close the capture file, enter this command without any parameter values.

The CF and CAPTUREFILE commands are identical. If no CAPTURE command has specified locations to be monitored, the CF and CAPTUREFILE commands have no effect.

NOTES

The CAPTURE command specifies the location to be monitored for value changes. Closing the capture file deletes the location specification. The simulator continues writing to an open capture file. The capture file must be closed within a reasonable time, to prevent the file from growing large.

Syntax:

```
CAPTUREFILE [<filename> [R | A]]
```

where:

<filename> Name of the capture file.

Examples:

```
CAPTUREFILE TEST.CAP              Open capture file TEST.CAP  
CF TEST4.CAP A                    Open capture file TEST4.CAP; append new entries
```

CCR

Set Condition Code Register

The CCR command sets the condition code register (CCR in the CPU) to the specified hexadecimal value. The value entered with the command displays in the CPU Window.

NOTE

The CCR bit designators are in the lower portion of the CPU window. The CCR binary pattern is 111HINZC (H is half-carry, I is IRQ interrupt mask, N is negative, Z is zero and C is carry). A letter in these designators means that the corresponding bit is set; a period means that the corresponding bit is clear.

Syntax:

CCR <n>

where:

<n> The new hexadecimal value for the CCR.

Example:

CCR E4

Assign the value E4 to the CCR. This makes the binary pattern 11100100; the N bit set, other bits clear.

CHIPMODE

Set Chip for Simulation

The CHIPMODE command displays the *Pick Device* dialog containing a list of the HC05 devices that can be simulated with ICS05C for Windows. Select the device in the following window:

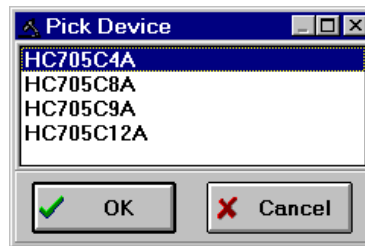

Figure 7-2. Pick Device Dialog

NOTE

The selection of a new chip does not take effect until the next debugging session.

Syntax:

CHIPMODE

Example:

CHIPMODE

Choose the device for simulation.

CLEARMAP

Clear .MAP File

The CLEARMAP command removes the current MAP file from memory, forcing the debugger to show disassembled code in the Code Windows instead of source code. Symbols defined using the SYMBOL command are not affected by this command. (The NOMAP command is identical to CLEARMAP.)

Syntax:

```
CLEARMAP
```

Example:

```
CLEARMAP           Clears symbols and their definitions.
```

CLEARSYMBOL

Clear User Symbols

The CLEARSYMBOL command removes all the user-defined symbols (created with the SYMBOL command). Debug information from MAP files, used for source level debugging, is not affected by the CLEARSYMBOL command.

NOTE

List the current user-defined symbols using the SYMBOL command.

Syntax:

```
CLEARSYMBOL
```

Example:

```
CLEARSYMBOL           Clears user defined symbols.
```

COLORS

Set Simulator Colors

The COLORS command opens the *Change Window Colors* dialog that lets you choose the text and background colors for windows in the ICS05CW simulator. After you set colors options for the windows, save the changes using the SAVEDESK command. For more information about using the *Change Window Colors* dialog, see paragraph 6.22.2.

Syntax:

```
COLORS
```

Example:

```
COLORS
```

Open the colors window.

CYCLES

Set Cycles Counter

The CYCLES command changes the value of the cycle counter. The cycle counter counts the number of processor cycles that have passed during execution. The Cycle Window shows the cycle counter. The cycle count can be useful for timing procedures.

Syntax:

```
CYCLES <n>
```

where:

<n> Integer value for the cycles counter.

Examples:

```
CYCLES 0 Reset cycles counter.
```

```
CY 1000 Set cycle-counter value to 1000.
```

DASM

Disassemble Memory

The DASM command disassembles machine instructions, displaying the addresses and their contents as disassembled instructions in the debug window.

- If the command includes an address value, one disassembled instruction is shown, beginning at that address.
- If you enter the command without any parameter values, the software finds the most recently disassembled instruction then shows the next instruction, disassembled.
- If the command includes *startrange* and *endrange* values, the software shows disassembled instructions for the range.

NOTE

If you enter the DASM command with a range, sometimes the disassembled instructions scroll through the status window too rapidly to view. In this case, enter the LF command, to record the disassembled instructions in a logfile, or use the scroll bars in the status window.

Syntax:

```
DASM [address | startrange endrange]
```

where:

<i>address</i>	First address of three instruction opcodes to be disassembled.
<i>startrange</i>	Starting address for a range of instructions to be disassembled.
<i>endrange</i>	Ending address for a range of instructions to be disassembled.

Examples:

```
DASM 300
0300          A6E8  LDA #0E8
DASM 200 208
0200          5F   CLRX
0201          A680  LDA #80
0203          B700  STA PORTA
0205          A6FE  LDA #FE
0207          B704  STA DDRA
```

DDRA

Set Port A Direction Register

The DDRA command assigns the specified byte value to the port A data direction register (DDRA). Bits assigned 0 denote input pins; bits assigned 1 denote output pins.

Syntax:

```
DDRA <n>
```

where:

<n> The byte value to be placed into DDRA.

Examples:

```
DDRA FF                    Set all port A pins to be outputs.
```

```
DDRA 00                    Set all port A pins to be inputs.
```

DDRB

Set Port B Direction Register

The DDRB command assigns the specified byte value to the port B data direction register (DDRB). Bits assigned 0 denote input pins; bits assigned 1 denote output pins.

Syntax:

```
DDRB <n>
```

where:

<n> The byte value to be placed into DDRB.

Examples:

```
DDRB 03                    Set the lower two bits of port B pins as outputs, set the  
                             others to be inputs.
```

```
DDRB FF                    Set all port B pins to be outputs.
```

DUMP

Dump Memory to Screen

The DUMP command sends contents of a block of memory to the status window, in bytes, words, or longs. The optional variant specifies whether to fill the block in bytes (.B, the default), in words (.W), or in longs (.L).

NOTE

When you enter the DUMP command, sometimes the memory contents scroll through the debug window too rapidly to view. Accordingly, you can either the LF command to record the memory locations in a logfile, or use the scroll bars in the status window.

Syntax:

```
DUMP [.B | .W | .L] <startrange> <endrange> [<n>]
```

where:

<startrange>	Beginning address of the memory block.
<endrange>	Ending address of the memory block (range).
<n>	Optional number of bytes, words, or longs to be written on one line.

Examples:

DUMP C0 CF	Dump array of RAM values, in bytes.
DUMP.W 300 37S	Dump ROM code in address 300-37S in words.
DUMP.B 200 300	Dump contents of addresses 200-300 in rows of eight bytes.

EVAL

Evaluate Expression

The EVAL command evaluates a numerical term or simple expression, giving the result in hexadecimal, decimal, octal, and binary formats. In an expression, spaces must separate the operator from the numerical terms.

NOTE

Octal numbers are not valid as parameter values. Operand values must be 16 bits or less. If the value is an ASCII character, this command also shows the ASCII character as well. The parameters for the command can be a number, or a sequence of: number, space, operator, space, and number. Supported operations are addition (+), subtraction (-), multiplication (*), division (/), logical AND (&), and logical OR (^).

Syntax:

```
EVAL <n> [<op> <n>]
```

where:

<n>	Alone, the numerical term to be evaluated. Otherwise either numerical term of a simple expression.
<op>	The arithmetic operator (+, -, *, /, &, or ^) of a simple expression to be evaluated.

Examples:

```
EVAL 45 + 32
```

```
0077H 119T 0001670 0000000001110111Q "w"
```

```
EVAL 100T
```

```
0064H 100T 0001440 0000000001100100Q "d"
```

EXIT or QUIT

Exit/Quit Application

The EXIT command terminates the software and closes all windows. The QUIT command is identical to EXIT.

Syntax:

```
EXIT
```

Example:

```
EXIT
```

Finish working with the program.

GO

Begin Program Execution

The GO command starts execution of code at the current program counter (PC) address, or at an optional specified address.

The G, GO, and RUN commands are identical.

If you enter only one address, that address is the starting address. If you enter a second address, the execution stops at that address. If you specify only one address, the execution continues until you press a key, it arrives at a breakpoint, or an error occurs.

NOTE

If you want to see the windows update with information during execution of code, use the STEPFOR command.

Syntax:

```
GO [<startaddr> [<endaddr>]]
```

where:

<i><startaddr></i>	Optional execution starting address. If the command does not have a <i><startaddr></i> value, execution begins at the current PC value.
<i><endaddr></i>	Optional execution ending address.

Examples:

GO	Begin code execution at the current PC value.
GO 346	Begin code execution at address 346.
G 300 371	Begin code execution at address 300. End code execution just before the instruction at address 371.
RUN 300	Begin code execution at address 300.

GOMACRO

Execute Macro after Break

The GOMACRO command executes the program in the simulator beginning at the address in the program counter (PC). Execution continues until you press a key, until it arrives at a breakpoint, or until an error occurs. Afterwards it runs the specified macro file just like the MACRO command.

Syntax:

```
GOMACRO <filename>
```

where:

<filename>

The name of a script file to be executed, with or without extension .MAC, or a pathname that includes an asterisk (*) wildcard character. When the asterisk is entered, the command displays a list of appropriate files, from which you can select the required file.

Example:

```
GOMACRO AVCALC.MAC
```

Begin code execution at the current PC value; at breakpoint execute macro AVCALC.MAC.

GOTIL

Execute Until Address

The GOTIL command executes code beginning at the address in the program counter (PC). Execution continues until the program counter contains the specified ending address, or until you press a key or the Stop button on the ICS05CW toolbar, or until it reaches a breakpoint, or until an error occurs.

Syntax:

```
GOTIL <endaddr>
```

where:

<endaddr> The address at which execution stops.

Example:

```
GOTIL 2F0                    Executes code up to address 2F0.
```

GOTOCYCLE **Execute to Cycle Counter Value**

The GOTOCYCLE command executes the program in the simulator beginning at the address in the program counter (PC). Execution continues until the cycle counter is equal to or greater than the specified value, or until you press a key or the Stop button on the ICS05CW toolbar, until it reaches a breakpoint, or an error occurs.

Syntax:

```
GOTOCYCLE <n>
```

where:

 <n> Cycle-counter value at which execution stops.

Examples:

```
GOTOCYCLE 100                      Execute the program until the cycle counter equals 100.
```

H

Set/Clear Half-Carry Bit

The H command sets or clears the H bit in the condition code register (CCR).

NOTE

The CCR bit designators are in the lower portion of the CPU window. The CCR pattern is 111HINZC (H is half-carry, I is IRQ interrupt mask, N is negative, Z is zero and C is carry). A letter in these designators means that the corresponding bit of the CCR is set; a period means that the corresponding bit is clear.

Syntax:

H 0|1

Examples:

H 1

Sets the H bit in the CCR.

H 0

Clear the H bit of the CCR.

HELP

Open Help

The **HELP** command opens the Windows help file for the program. An alternative way to open the help system is to press the F1 key.

Syntax:

`HELP`

Examples:

`HELP`

Open the help system

I **Set/Clear Interrupt Mask**

The I command sets or clears the I bit of the condition code register (CCR).

NOTE

The CCR bit designators are in the lower portion of the CPU window. The CCR pattern is 111HINZC (H is half-carry, I is IRQ interrupt mask, N is negative, Z is zero and C is carry). A letter in these designators means that the corresponding bit of the CCR is set; a period means that the corresponding bit is clear.

Syntax:

I 0|1

Examples:

I 1	Set the I bit in the CCR.
I 0	Clear the I bit of the CCR.

INFO

Display Line Information

The INFO command displays information about the line highlighted in the source window. Information displayed includes the name of the file in the window, the line number, the address, the corresponding object code, and the disassembled instruction.

Syntax:

```
INFO
```

Example:

```
INFO                                Display information about the cursor line.
Filename:PODTEST.ASM              Line number:6
Address:$0100
Disassembly:START                  5F CLRX
```

INPUTA

Set Port A Inputs

The INPUTA command sets the simulated inputs to port A. The CPU reads this input value when port A is set as an input port.

NOTE

If the ICS05C circuit board is connected, port A inputs come from the board, so this command has no effect.

Syntax:

```
INPUTA <n>
```

where:

<n> Eight-bit simulated value for port A.

Example:

```
INPUTA AA                    Simulate the input AA on port A.
```

INPUTB

Set Port B Inputs

The INPUTB command sets the simulated inputs to port B. The CPU reads this input value when port B is set as an input port.

NOTE

If the ICS05C circuit board is connected, port B inputs come from the board, so this command has no effect.

Syntax:

```
INPUTB <n>
```

where:

<n> Eight-bit simulated value for port B.

Example:

```
INPUTB 01                    Simulate the input 01 on port B.
```

INPUTS

Show Port Inputs

The INPUTS command shows the simulated input values to port A and B (entered via the INPUTA or INPUTB commands).

NOTE

If the ICS05C circuit board is connected, this command shows input values from the board.

Syntax:

```
INPUTS
```

Example:

```
INPUTS
```

Show I/O port input values.

```
Port A - AA
```

```
Port B - 01
```

IRQ

Set IRQ Pin State

The IRQ command assigns the state value of the MCU IRQ pin. To see the current simulated value on the pin, enter this command without any parameter value. The external interrupt is simulated as a level or edge/level triggered interrupt, depending on the IRQ bit in the MOR register. (The INT command is identical).

NOTE

If the ICS05C circuit board is connected, the IRQ pin value come from the board, so this command has no effect.

Syntax:

```
IRQ [0 | 1]
```

Examples:

INT 0	Assign 0 to the IRQ pin.
IRQ 1	Assign 1 to the IRQ pin.

LISTOFF

Turn Off Step Listing

The LISTOFF command turns off the screen listing of the step-by-step information for stepping. Register values and program instructions do not appear in the status window as code runs. (This display state is the default when the software is first started.)

To turn on the display of stepping information, use the LISTON command.

Syntax:

```
LISTOFF
```

Example:

```
LISTOFF
```

Do not show step information.

LISTON

Turn On Step Listing

The LISTON command turns on the screen listing of the step by step information during stepping. The register values and program instructions are displayed in the status window while running code. The values shown are the same values seen by the REG instruction.

To turn off this step display, use the LISTOFF command.

Syntax:

```
LISTON
```

Example:

```
LISTON
```

Show step information.

LOAD

Load S-Records

The LOAD command loads an S-record (*.S19) object file and associated map file into the debugger. Entering this command without a filename value brings up a list of .S19 files in the current directory. Select a file for loading from this list. Upon loading, if the reset vector is defined in the code, the debugger sets the PC to that address.

Syntax:

```
LOAD [filename]
```

where:

<filename>

The name of the .S19 file to be loaded. The .S19 extension can be omitted. The filename value can be a pathname that includes an asterisk (*) wildcard character. If so, the command displays a window that lists the files in the specified directory, having the .S19 extension.

Examples:

LOAD PROG1.S19	Load file PROG1.S19 and its map file into the simulator at the load addresses in the file.
LOAD PROG2	Load file PROG2.S19 and its map file into the simulator at the load addresses in the file.
LOAD A:	Display the names of the .S19 files on the diskette in drive A:, for user selection.
LOAD	Display the names of the .S19 files in the current directory, for user selection.

LOADDESK

Load Desktop Settings

The LOADDESK command loads the debugger window (desktop) settings for window position, size, and visibility, allowing you to choose how the windows will be set up for the project.

Use the SAVEDESK command to save the debugger window settings to the desktop file.

Syntax:

```
LOADDESK
```

Example:

```
LOADDESK
```

Get window settings from desktop file.

LOADMAP

Load Map File

The LOADMAP command loads into the ICS05CW simulator a map file that contains source level debug information. Entering this command without a filename parameter brings up a list of .MAP files in the current directory. From this a file can be selected directly for loading map file information.

Syntax:

```
LOADMAP [<filename>]
```

where:

<filename>

The name of a map file to be loaded. The .MAP extension can be omitted. The filename value can be a pathname that includes an asterisk (*) wildcard character; If so, the command displays a lists of all files in the specified directory that have the .MAP extension.

Examples:

```
LOADMAP PROG.MAP
```

Load map file PROG.MAP into the host computer.

```
LOADMAP PROG1
```

Load map file PROG1.MAP into the host computer.

```
LOADMAP A:
```

Displays the names of the .MAP files on the diskette in drive A:

```
LOADMAP
```

Display the names of the .MAP files in the current directory.

LOGFILE

Open/Close Log File

The LOGFILE command opens an external file to receive log entries of the commands entered in the command line of the ICS05CW Status Window and the system responses to those commands that appear in the Status Window message area.

- If the specified file does not exist, this command creates the file.
- If the file specified file exists, you can enter an optional parameter to specify whether to overwrite existing contents (R, the default) or to append the log entries (A). If this parameter is omitted, a prompt window asks if you want to overwrite the existing file or append information to the existing file.

While logging is in effect, any line appended to the command log window is also written to the log file.

Logging continues until another LOGFILE or LF command is entered without any parameter values. This second command disables logging and closes the log file.

The command interpreter does not assume a filename extension.

Syntax:

```
LF [filename] [R | A]
```

where:

filename The filename of the log file (or logging device to which the log is written).

Examples:

```
>LF TEST.LOG R                Start logging. Overwrite file TEST.LOG (in the current directory) with all lines that appear in the status window.
```

```
>LF TEMP.LOG A                Start logging. Append to file TEMP.LOG (in the current directory) all lines that appear in the status window.
```

```
>LOGFILE                      (If logging is enabled): Disable logging and close the log file.
```

MACRO

Execute Batch File

The MACRO command executes a macro file, a file that contains a sequence of debug commands. Executing the macro file has the same effect as executing the individual commands, one after another. The SCRIPT command is identical.

Entering this command without a filename value brings up a list of macro (.MAC) files in the current directory. You can select a file for execution directly from this list.

NOTE

A macro file can contain the MACRO command, allowing you to next macro files up to 16 levels deep.

The most common use of the REM and WAIT commands is within macro files. The REM command displays comments while the macro file executes; the WAIT command establishes a pause between the execution of the macro file commands.

If a startup macro file is in the directory, startup routines run the macro file each time the application starts. See the STARTUP command for more information.

Syntax:

```
MACRO <filename>
```

where:

<filename> The name of a macro file to be executed, with or without extension .MAC. The filename can be a pathname that includes an asterisk (*) wildcard character. If so, the software displays a list of macro files, for selection.

Examples:

MACRO INIT.MAC	Execute commands in file INIT.MAC.
SCRIPT *	Display names of all .MAC files (then execute the selected file).
MACRO A:*	Display names of all .MAC files in drive A (then execute the selected file).
MACRO	Display names of all .MAC files in the current directory, then execute the selected file.

MACROEND Stop Saving Commands to Batch File

The MACROEND command closes the macro file in which the software has saved debug commands. (The MACROSTART command opened the macro file). This stops saving debug commands to the macro file.

Syntax:

```
MACROEND
```

Example:

```
MACROEND
```

Stop saving debug commands to the macro file, then close the file.

MACROSTART Save Debug Commands to Batch File

The MACROSTART command opens a macro file and saves all subsequent debug commands to that file for later use. This file must be closed by the MACROEND command before the ICS05CW session is ended.

Syntax:

```
MACROSTART [<filename>]
```

where:

<i><filename></i>	The name of the macro file to save commands. The .MAC extension can be omitted. The filename can be a pathname followed by the asterisk (*) wildcard character; if so, the command displays a list of all files in the specified directory that have the .MAC extension.
-------------------------	--

Example:

```
MACROSTART TEST.MAC    Save debug commands in macro file TEST.MAC
```

MD

Display Memory at Address

The MD command displays (in the memory window) the contents of memory locations beginning at the specified address. The number of bytes shown depends on the size of the window and whether ASCII values are displayed. If a log file is open, this command also writes the first 16 bytes to the log file. The MD and SHOW commands are identical.

Syntax:

```
MD <address>
```

where:

<address>

The starting memory address for display in the upper left corner of the memory window.

Examples:

```
MD 200
```

Display the contents of memory beginning at address 200.

```
SHOW 100
```

Display the contents of memory beginning at address 100.

MM

Modify Memory

The MM command directly modifies the contents of memory beginning at the specified address. The optional variant specifies whether to fill the block in bytes (.B, the default), in words (.W), or in longs (.L). If, however, the command has only an *address* value, the *Modify Memory* dialog (Figure 7-3) appears showing the specified address and its present value. Use the dialog to enter a new value for the address or to modify the address type by selecting 8-bit bytes, 16-bit words, 32-bit longs. To modify several memory locations from this dialog, enter the new value in the *New Value* text box and press the >> button to increment the current address, or the << button to decrement the current address, or the = button to display the same address.

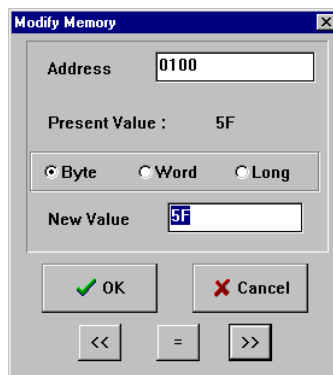

Figure 7-3. Modify Memory Dialog

If the MM command includes optional data values, the software assigns the values to the specified addresses sequentially, then the command ends. No window appears in this case.

Syntax:

```
MM [.B|.W|.L] <address>[<n> ...]
```

where:

<address>	The address of the first memory location to be modified.
<n>	The value(s) to be stored (optional).

Examples:

With only one address:

MM 90	Start memory modify at address \$90.
MM 300 00	Assign value 00 to address \$300.
MM 100 00 01 10 11	Assign values 00-11 to bytes 100-103.
MM.L 200 123456	Place long value \$123456 at address \$200.

N**Set/Clear Negative Bit**

The N command sets or clears the N bit of the condition code register (CCR).

NOTE

The CCR bit designators are in the lower portion of the CPU window. The CCR pattern is 111HINZC (H is half-carry, I is IRQ interrupt mask, N is negative, Z is zero and C is carry). A letter in these designators means that the corresponding bit of the CCR is set; a period means that the corresponding bit is clear.

Syntax:

N 0|1

Example:

N 1

Set the N bit of the CCR.

N 0

Clear the N bit of the CCR.

NOBR

Remove Breakpoints

The NOBR command removes one or all active breakpoints. If this command has an address value, it removes the breakpoint at that address. If this command has no parameter values, it removes all current breakpoints. To set breakpoints use the BR command.

An alternative way for clearing a breakpoint in the code window is to position the cursor on a line of code, then press the right mouse button and select Toggle Breakpoint at Cursor menu item. This removes the breakpoint from the line.

Syntax:

```
NOBR [<address>]
```

where:

<address> Optional address of a single breakpoint to be removed.

Examples:

```
NOBR                              Remove all current instruction breakpoints.  
NOBR 120                         Remove the instruction breakpoint at address 120.
```

NOSYMBOL

Clear User Symbols

The NOSYMBOL command removes all user defined symbols created using the SYMBOL from memory. Symbols are created using the SYMBOL command. Symbols defined via a loaded MAP file are not affected.

Syntax:

```
NOSYMBOL
```

Example:

```
NOSYMBOL
```

Clears user defined symbols and their definitions.

PC

Set Program Counter

The PC command assigns the specified value to the MCU program counter. As the PC always points to the address of the next instruction to be executed, assigning a new PC value changes the flow of code execution; the code windows change accordingly. The value entered with the command is displayed in the CPU Window.

An alternative way for setting the PC in a code window is to position the cursor on a line of code, then press the right mouse button and select the Set PC at Cursor menu item. This assigns the address of that line to the PC.

Syntax:

```
PC <address>
```

where:

<address> The new PC value.

Example:

```
PC 0200                      Sets the PC value to 0200.
```

POD

Change Serial Port

The POD command connects to the ICS05C circuit board through the specified serial (COM) port. If successful, this command responds with the current status of ports, reset, and IRQ pins on the board. The command also shows the version of the board.

Syntax:

```
POD <n>
```

where:

<n> The number (1...8) of a serial port (COM1 through COM8) on the PC.

Example:

```
POD 1                                   Connect to serial port COM1.  
Port A - 80  
Port B - 00  
Reset - 1  
IRQ - 1  
Version - 01
```

PORTA or PRTA

Set Port A Output Latches

The PORTA command assigns the specified value to the port A output register latches. (The PRTA command is an alternate form of the PORTA command).

NOTE

If the ICS05C circuit board is connected, the system sends the *n* parameter value of this command to the board.

Syntax:

```
PORTA <n>
```

where:

<*n*> The new value for the port A output latches.

Example:

```
PORTA FF            Set all port A output latches high.
```

PORTB or PRTB

Set Port B Output Latches

The PORTB command assigns the specified value to the port B output register latches. (The PRTB command is an alternate form of the PORTB command).

NOTES

If the ICS05C circuit board is connected, the system sends the *n* parameter value of this command to the board.

Syntax:

```
PORTB <n>
```

where:

<*n*> The new value for the port B output latches.

Example:

```
PORTB 03            Set the port B output latches to 03.
```

PROGRAM

Start Programmer

The PROGRAM command starts the programmer. The programmer is used for such procedures as programming, verifying, blank-checking the sample EPROM, and programming the MOR byte for the desired device.

Programming software installed on the host computer can control the M68ICS05C pod programming socket (U2). The host computer can send RESET, CLOCK, DATA, and other control signals from to the pod through the serial connection.

After entering the PROGRAM command and before beginning to program the EPROM, follow the directions in the popup windows for setting the power switches and control signals. After these have been set, the Pick window displays the command choices summarized in Table 7-3.

During programming, you may use the three programming windows:

Pick Window

The Pick Window (Figure 7-4) displays all programming actions and functions.

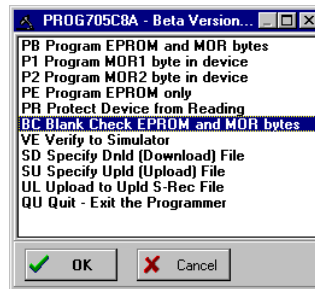

Figure 7-4. PROG05P Programmer Pick Window

Status Window

The Programmer Status Window accepts programming commands on the command line or from the Pick Window, then displays the command results in the message area. It is identical in form and function to the ICS05CW Status Window.

File Window

The Programmer File window identifies the filenames of the downloaded and uploaded files.

PROGRAM

(continued)

Table 7-3. PROGRAM Commands

Cmd	Function	Description
BC	Blank Check - \$00 everywhere?	Checks whether the device has been erased.
PB	Program Both EPROM then MOR	Programs all of the EPROM space, then the MOR byte of the HC705C device from the download file specified by the SD programming command and shown in the Programmer Files Window.
PE	Program EPROM only	Programs only the EPROM space of the HC705P9 (not the MOR) from the file specified in the file window.
PM	Program MOR byte in device	Asks for a value for the MOR byte and then programs that location only in the HC705C device.
QU	Quit; Exit the Programmer	Powers down the programmed device and returns to the simulator.
SD	Specify Dnld (Download) File	Gives the name of the S19 file to be programmed (shown in file window).
SU	Specify Upld (Upload) File	Gives the name of the S19 file in which to upload code (shown in file window).
UL	Upload to Upld S-Rec File	Reads the entire EPROM space (including MOR byte) of the HC705C device and places it into the upload file. Verifies that an upload file has been specified.
VE	Verify to Simulator OR -Verify to Dnld S-Rec File	Verifies the device to the download file specified in the status window.

To execute a programming command in the Pick Window, double-click on the command (or select the command and press the OK button).

The programming commands are saved in a file. The default file for downloading command comes from simulator memory. If you wish to use another S19 file to program the device, use the SD command to open the dialog and enter or select the new download filename. The Programmer Files window shows the download and upload filenames. When MCU programming completes, the ICS05CW simulator interface returns.

PROGRAM

(continued)

Syntax:

PROGRAM

Example:

PROGRAM

Starts the programmer.

R

Use Register Files

The R command pulls up windows for the register files (sold separately by P&E) and starts interactive setup of such system registers as the I/O, timer, and COP.

Entering this command opens the register files window, which can present a list of register files for the device (if set up previously). Selecting a file brings up a display of values and significance for each bit of the register. The user can view any of the registers, modify their values, and store the results back into memory.

An alternate way to bring up the register files window is to press the Register Files speed button.

Syntax:

R

Example:

R

Start interactive system register setup.

REG

Show Registers

The REG command displays the contents of the CPU registers in the Status window. (The STATUS command is identical to the REG command.)

Syntax:

```
REG
```

Example:

```
REG
```

Displays the contents of the CPU registers.

RESET

Simulate Processor Reset

The RESET command simulates a reset of the MCU and sets the program counter (PC) to the contents of the reset vector. This command does not start execution of user code. (To reset and execute code, use the RESETGO command.)

Syntax:

```
RESET
```

Example:

```
RESET
```

Simulate reset of the MCU.

RESETGO

Reset and Restart MCU

The RESETGO command simulates a reset of the MCU, sets the program counter (PC) to the contents of the reset vector, then starts execution from that address.

Syntax:

```
RESETGO
```

Example:

```
RESETGO
```

Simulate reset of the MCU and start execution of code.

SAVEDESK

Save Desktop Settings

The SAVEDESK command saves window position, size, and other desktop settings. Opening the application or entering the LOADDESK command loads the saved settings.

Syntax:

```
SAVEDESK
```

Example:

```
SAVEDESK           Save window settings for the application.
```

SHOWBREAKS

Display Breakpoint Window

The SHOWBREAKS command brings up the Breakpoint Window that displays the breakpoints used in the current debugging session. Breakpoints can be modified through this window

Syntax:

```
SHOWBREAKS
```

Example:

```
SHOWBREAKS
```

Open the breakpoint window.

SHOWCODE

Display Code at Address

The SHOWCODE command displays code in the code windows beginning at the specified address, without changing the value of the program counter (PC). The code window shows either source code or disassembly from the given address, depending on which mode is selected for the window. This command is useful for browsing through various modules in the program. To return to code where the PC is pointing, use the SHOWPC command.

Syntax:

```
SHOWCODE <address>
```

where:

<address> The address or label where code is to be shown.

Example:

```
SHOWCODE 200                      Show code starting at location $200.
```

SHOWMAP

Show Information in Map File

The SHOWMAP command lets you view information from the current map file stored in the memory. All symbols defined in the source code used for debugging will be listed. The debugger defined symbols, defined with the SYMBOL command, will not be shown. The MAP command is identical to the SHOWMAP command.

Syntax:

```
SHOWMAP
```

Example:

```
SHOWMAP
```

Shows symbols from the loaded map file and their values.

SHOWTRACE

Display Trace Window

The SHOWTRACE command displays the trace window, showing the last 1024 instructions that were executed after the TRACE command is used.

Syntax:

```
SHOWTRACE
```

Example:

```
SHOWTRACE           Open the trace window.
```

SNAPSHOT

Save Window Data to Log File

The SNAPSHOT command sends textual information about the debugger windows to the open log file. If no log file is open, the command has no effect.

Syntax:

```
SNAPSHOT
```

Example:

```
SNAPSHOT           Save window data to the log file.
```

SP**Set Stack Pointer**

The SP command assigns the specified value to the stack pointer (SP) used by the CPU. The value entered with the command should be reflected in the CPU Window.

Syntax:

SP <n>

where:

<n> The new stack pointer value.

Example:

SP \$E0 Set the stack pointer value to \$E0.

SS

Execute Source Step(s)

The SS command steps through a specified number of source code instructions, beginning at the current program counter (PC) address value, then halts. All windows are refreshed as each instruction is executed. This makes the SS command useful for high level language compilers (such as C) so that the user can step through compiler source code instead of assembly instructions.

If the number argument is omitted, one source instruction is executed. If the SS command is entered with an *n* value, the command steps through *n* source instructions.

Syntax:

```
SS [<n>]
```

where:

<n> number of instructions to step through.

Examples:

SS	Step through the instruction at the PC address value.
SS 8	Step through eight instructions, starting at the current PC address value.

ST or STEP or T

Execute Single Step

The STEP command steps through a specified number of assembly instructions, beginning at the current program counter (PC) address value, then halts. All windows are refreshed as each instruction is executed. If the number argument is omitted, one instruction is executed. If you enter the STEP command with a parameter value, the command steps through that many instructions. (The ST and T commands are identical to the STEP command.)

Syntax:

```
STEP [<n>]
```

where:

<n> The hexadecimal number of instructions to be executed by each command.

Examples:

STEP	Execute the assembly instruction at the PC address value.
ST 2	Execute two assembly instructions, starting at the PC address value.

STACK

Show Stack Window

The **STACK** command opens the HC05 Stack Window, which shows the stack pointer (SP) value, data stored on the stack, and results of an RTS or RTI instruction.

Syntax:

```
STACK
```

Example:

```
STACK           Open the stack window.
```

STEPFOR

Step Forever

The STEPFOR command continuously executes instructions, one at a time, beginning at the current Program Counter (PC) address. Execution continues until an error condition occurs, until it reaches a breakpoint, or until you press a key or the Stop button on the ICS05CW toolbar. All windows are refreshed as each instruction is executed.

Syntax:

```
STEPFOR
```

Example:

```
STEPFOR
```

Step through instructions continuously.

STEPTIL

Step Until Address

The STEPTIL command continuously steps through instructions beginning at the current program counter (PC) address until the PC value reaches the specified address. Execution continues to the specified address or until you press a key or the Stop button on the ICS05CW toolbar, or it reaches a breakpoint, or until an error occurs.

Syntax:

```
STEPTIL <address>
```

where:

<address> Execution stop address. This must be an instruction address.

Example:

```
STEPTIL 0200           Execute instructions continuously until PC value is 0200.
```

SYMBOL

Add Symbol

The SYMBOL command creates a new symbol, which can be used anywhere in the debugger, in place of the symbol value. If this command is entered with no parameters, it will list the current user-defined symbols. If parameters are specified, the SYMBOL command will create a new symbol.

The symbol label is case-insensitive and has a maximum length of 16T. It can be used with the ASM and MM commands and replaces all addresses in the Code and Variables windows.

Syntax:

```
SYMBOL [<label> <value>]
```

where:

<label>	The ASCII-character string label of the new symbol.
<value>	The value of the new symbol (label).

Examples:

```
SYMBOL
```

Show the current user-defined symbols.

```
SYMBOL timer_control $08
```

Define new symbol “timer_control”, with value \$08. Subsequently, to modify the value of “timer_control”, enter the command:

```
MM timer_control new_value
```

TRACE

Enable/Disable Tracing

The TRACE command enables or disables instruction captures. When tracing is enabled, the debugger records instructions in a 1024-element circular buffer. Note that tracing slows execution somewhat.

The debugger disassembles captured information when buffer contents are viewed through the trace window. To view tracing results, use the SHOWTRACE command. If tracing is not enabled or if a trace slot is empty, the Trace Window will display the message *No Trace Available*. To clear the Trace Window, toggle tracing OFF and then ON using the TRACE command.

Syntax:

```
TRACE
```

Example:

```
TRACE           Enable (or disable) instruction tracing.
```

UPLOAD_SREC

Upload S Record to Screen

The UPLOAD_SREC command uploads the contents of the specified memory block (range), in .S19 object file format, displaying the contents in the status window. If a log file is opened, UPLOAD_SREC puts the information into the log file as well.

NOTE

If the UPLOAD_SREC command is entered, sometimes the memory contents scroll through the debug window too rapidly to view. Accordingly, either the LOGFILE command should be used, which records the contents into a file, or use the scroll bars in the status window.

Syntax:

```
UPLOAD_SREC <startrange> <endrange>
```

where:

<startrange>	Beginning address of the memory block.
<endrange>	Ending address of the memory block (range)

Example:

```
UPLOAD_SREC 300 7FF Upload the 300-7FF memory block in .S19 format.
```

VAR

Display Variable

The VAR command displays the specified address and its contents in the Variables window for viewing during code execution. Variants of the command display a byte, a word, a long, or a string. As the value at the address changes, the variables window updates the value. The maximum number of variables is 32.

In ASCII displays of variables, control characters or other non-printing characters appear as periods (.). Byte, word, long, or string variants determine the display format:

- Byte (.B): hexadecimal and binary (the default)
- Word (.W): hexadecimal and decimal
- Long (.L): hexadecimal and decimal
- String (.S): ASCII characters

The optional *<n>* parameter specifies the number of string characters to be displayed; the default value is 1. The *<n>* parameter has no effect for byte, word, or long values.

Syntax:

```
VAR [.B|.W|.L|.S] <address> [<n>]
```

where:

<i><address></i>	The address of the memory variable.
<i><n></i>	Optional number of characters for a string variable; default value is 1, does not apply to byte or word variables.

Examples:

VAR C0	Show byte value of address C0 (hex and binary)
VAR.B D4	Show byte value of address D4 (hex and binary)
VAR.W E0	Show word value of address E0 (hex & decimal)
VAR.S C0 5	Show the five-character ASCII string at address C0

VERSION or VER

Display Software Version

The VERSION command displays the version and date of the software. (VER is an alternate form of this command.)

Syntax:

VERSION

Examples:

VERSION

Display version and date of the software.

VER

Display version and date of the software.

WAIT

Wait for *n* Cycles

The WAIT command delays simulator command execution by the specified number of cycles. This command is used in MACRO files to control when inputs come into the simulator. If a WAIT command is encountered, control is passed back to the keyboard. Then the macro file execution waits for a command to be entered such as GO or STEP, which starts MCU execution once again. As soon as the number of cycles that pass is equal to the <n> value of the WAIT command, the simulator resumes executing commands of the macro file until another WAIT is encountered or the two mentioned conditions happens again.

Syntax:

```
WAIT <n>
```

where:

<n> The hexadecimal number of cycles to wait.

Example:

```
WAIT A                    Delay command execution for 10 MCU cycles.
```

WHEREIS

Display Symbol Value

The WHEREIS command displays the value of the specified symbol. Symbol names are defined through source code or the SYMBOL command. Alternatively, this command returns the symbol at a specified address.

Syntax:

```
WHEREIS <symbol> | <address>
```

where:

<i><symbol></i>	A symbol listed in the symbol table.
<i><address></i>	Address for which a symbol is defined.

Examples:

WHEREIS START	Display the symbol START and its value.
WHEREIS 0300	Display the value 0300 and its symbol name if any.

X or XREG

Set X Register Value

The X command sets the index (X) register to the specified value. The value entered with the command is displayed in the CPU Window. (The X command is identical to the XREG command.)

Syntax:

```
X <value>
```

where:

<value> The new value for the X register.

Examples:

```
X 05                            Set the index register value to 05.  
XREG F0                        Set the index register value to F0.
```

Z

Set/Clear Zero Bit

The Z command sets or clears the Z bit in the condition code register (CCR).

NOTE

The CCR bit designators are in the lower portion of the CPU window. The CCR pattern is 111HINZC (H is half-carry, I is IRQ interrupt mask, N is negative, Z is zero and C is carry). A letter in these designators means that the corresponding bit of the CCR is set; a period means that the corresponding bit is clear.

Syntax:

Z 0|1

Examples:

Z 0 Clear the Z bit of the CCR.

Z 1 Set the Z bit of the CCR.

CHAPTER 8

EXAMPLE PROJECT

8.1 OVERVIEW

This section provides information that will guide you through a first-time use of the ICS05CW software and through a typical setup of the WinIDE.

8.2 SETTING UP A SAMPLE PROJECT

To demonstrate how source code to be assembled is handled using the ICS05CW simulator, WinIDE editor, and CASM05W assembler software as an integrated development environment, consider as an example the following typical project.

NOTE

The sample files referred to are referenced for illustration purposes only and are not provided with the software. Create your own *.ASM files for your projects using the ICS05CW software components. For information about using files created by other assemblers, see paragraph 5.4.4.

8.2.1 Set Up the Environment

To begin the project, start the WinIDE editor and establish the desktop and environment settings for the project:

1. Start the WinIDE editor by selecting the icon from the Windows 95 Start Menu or by double-clicking on the icon ICS05CW Program Group in the Windows 3.1 Program Manager.
2. In the WinIDE editor, choose the Setup Environment option from the File menu to open the *Environment Settings* dialog.

3. Enter environment options for the modules of the WinIDE development environment, represented by the *General Editor*, *General Environment*, *EXE1*, *EXE2*, and *Assembler/Compiler* tabs. For the example project:
 - a. In the *General Environment* tab, choose the environment options you prefer. In the *%FILE% Parameter passed to external program is* text box, enter the path and filename (*MAIN.ASM*).
 - b. In the *General Editor* tab, choose the editing options you prefer.
 - c. In the *EXE1* tab, make sure the *EXE Path* text box points to the *ICS05CW.EXE* path and filename, and that the *Options* text box indicates the proper communications port (if the pod is to be used).
 - d. In the *Assembler/Compiler* tab, make sure these options are selected:
 - The *EXE Path* text box indicates the path and filename for the *CASM05W.EXE*.
 - The *Type* text box specifies the P&E *CASMW* Assembler.
 - To view the *CASM05W* window during assembly, check the *Show Assembler Progress* option in the *Assembly Preferences* section of the tab.
4. Press the OK button to save the settings made in the *Environment Settings* dialog tabs and close the dialog.

You have now set up the environment for your project. To save it for later use:

1. In the WinIDE, select the *Save Project As* option from the Environment menu.
2. In the dialog box, enter a path and a descriptive project filename with the PPF extension. Place the project file in the directory where the source files will be located.

8.2.2 Create the Source Files

Create new or edit existing source code files using the WinIDE editor:

1. From the File menu, choose the *New File* option to create a blank source window in which you can enter source code (or open an existing file using the *Open File* option). You can all the source code files in the WinIDE editor and work on them individually.
2. When you have created the new file or edited the existing file, from the File menu, choose the *Save File* option to assign a path and filename to the source file (or choose the *Save File As* option to assign a new path and filename to an existing file).
3. Create all the source code files required for the project.

The example project consists of 12 source code files created in the WinIDE editor. The files are then assembled into *.ASM files using WinIDE *Assemble/Compile* toolbar button. The 12 files are then listed in a separate file *MAIN.ASM*.

The *MAIN.ASM* file consists of \$INCLUDE functions, each followed by the filename for the source code file, followed by an optional comment describing the function of the code in that file. Using the \$INCLUDE function in a main file lets you organize your source code logically into a number of small files, ultimately making it easier to develop, manage, and work with the source code. For more information about using the \$INCLUDE function, see paragraph 5.6.4.

The example *MAIN.ASM* file:

```
*****
Include files
*****
$include "equates.asm"
$include "init.asm"
$include "charge.asm"
$include "dcharge.asm"
$include "options.asm"
$include "misc.asm"
$include "readv.asm"
$include "isr.asm"
$include "display.asm"
$include "eeprom.asm"
$include "text.asm"
$include "vectors.asm"
```

8.2.3 Assemble the Project

Now you are ready to assemble your project. In the WinIDE, follow these steps:

1. With the *MAIN.ASM* file in the active window, press the *Assemble/Compile File* button (third button from the left) on the WinIDE toolbar to start the assembler from the WinIDE editor.
2. The assembler concatenates the files in the source code window, assembles them, and creates the output *MAIN.ASM* file. *MAIN.ASM* replaces any previous assembly code file of the same name in the same directory.
3. If the assembler encounters errors during assembly, the assembler stops and the first error is displayed highlighted in red in the source file. To correct the errors, click on the *Debugger (EXE1)* toolbar button (left-most button) on the WinIDE toolbar to open or move to the ICS05CW simulator to debug the source code. When you have finished debugging the code in the ICS05CW simulator, return to the WinIDE editor by clicking the *Back to Editor* button (the left-most button) in the ICS05CW toolbar.
4. Continue assembling, debugging, and editing the source files until the assembly completes successfully.

5. Based on the *Output Control* options selected in the *Assembler/Compiler* tab of the *Environment Settings* dialog, the assembler creates additional output files with the filename of the main file and an extension which indicates the file type. The S19 and MAP files are required; the LST file is optional.
 - a. *MAIN.S19*: Motorola S-Record (S19) object code file that you can download into the simulator.
 - b. *MAIN.MAP*: Map file containing information necessary for source level debugging
 - c. *MAIN.LST*: Listing file.
6. The CASM05W window displays during assembly, showing the files and progress of the assembler in the Status area. When assembly completes successfully, the assembler window appears like the one shown in Figure 8-1.

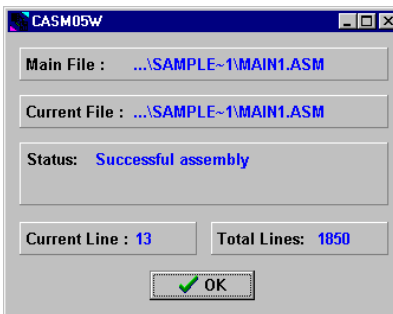

Figure 8-1. CASM05W Window

APPENDIX A

S-RECORD INFORMATION

A.1 OVERVIEW

The Motorola S-record format was devised for the purpose of encoding programs or data files in a printable format for transport between computer platforms. The format also provides for editing of the S-records and monitoring the cross-platform transfer process.

A.2 S-RECORD CONTENT

Each S-record is a character string composed of several fields which identify:

- record type
- record length
- memory address
- code/data
- checksum

Each byte of binary data is encoded in the s-record as a two-character hexadecimal number:

- The first character represents the high-order four bits of the byte
- The second character represents the low-order four bits of the byte

The five fields that comprise an S-record are shown in the Table A-1.

Table A-1. S-Record Fields

TYPE	RECORD LENGTH	ADDRESS	CODE/DATA	CHECKSUM
------	---------------	---------	-----------	----------

The S-record fields are described in Table A-2.

Table A-2. S-Record Field Contents

Field	Printable Characters	Contents
Type	2	S-record type — S0, S1, etc.
Record Length	2	Character pair count in the record, excluding the type and record length.
Address	4, 6, or 8	2-, 3-, or 4-byte address at which the data field is to be loaded into memory
Code/Data	0-2n	From 0 to n bytes of executable code, memory loadable data, or descriptive information. For compatibility with teletypewriter, some programs may limit the number of bytes to as few as 28 (56 printable characters in the S-record)
Checksum	2	Least significant byte of the one's complement of the sum of the values represented by the pairs of characters making up the record length, address, and the code/data fields

Each record may be terminated with a CR/LF/NULL. Additionally, an S-record may have an initial field to accommodate other data such as line number generated by some time-sharing systems.

Accuracy of transmission is ensured by the record length (byte count) and checksum fields.

A.3 S-RECORD TYPES

Eight types of S-records have been defined to accommodate the several needs of the encoding, transport, and decoding functions. The various Motorola upload, download, and other record transport control programs, as well as cross assemblers, linkers, and other file-creating or debugging programs, utilize only those S-records which serve the purpose of the program. For specific information on which S-records are supported by a particular program, consult the user manual for the program.

NOTE

The ICS05CW supports only the S0, S1, and S9 record types. All data before the S1 record is ignored. Thereafter, all records must be S1 type until the S9 record, which terminates data transfer.

An S-record format may contain the record types in Table A-3.

Table A-3. S-Record Types

Record Type	Description
S0	Header record for each block of S-records. The code/data field may contain any descriptive information identifying the following block of S-records. The address field is normally zeroes.
S1	Code/data record and the two-byte address at which the code/data is to reside.
S2-S8	Not applicable to ICS05CW
S9	Termination record for a block of S1 records. Address field may optionally contain the two-byte address of the instruction to which control is to be passed. If not specified, the first interplant specification encountered in the input will be used. There is no code/data field.

Only one termination record is used for each block of S-records. Normally, only one header record is used, although it is possible for multiple header records to occur.

A.4 S-RECORD CREATION

S-record format programs may be produced by dump utilities, debuggers, cross assemblers, or cross linkers. Several programs are available for downloading a file in the S-record format from a host system to an 8- or 16-bit microprocessor-based system.

A.5 S-RECORD EXAMPLE

A typical S-record format, as printed or displayed, is shown in this example:

Example

```
S00600004844521B
S1130000285F245F2212226A00042429008237C2A
S11300100002000800082529001853812341001813
S113002041E900084#42234300182342000824A952
S107003000144ED492
S9030000FC
```

In the example, the format consists of:

- an S0 header
- four S1 code/data records
- an S9 termination record

A.5.1 The S0 Header Record

The S0 header record is described in Table A-4.

Table A-4. S0 Header Record

Field	S-Record Entry	Description
Type	S0	S-record type S0, indicating a header record
Record Length	06	Hexadecimal 06 (decimal 6), indicating six character pairs (or ASCII bytes) follow
Address	0000	Four-character two-byte address field, zeroes
Code/Data	48 44 52	Descriptive information identified the following S1 records: ASCII H, D, and R — "HDR"
Checksum	18	Checksum of S0 record

A.5.2 The First S1 Record

The first S1 record is described in Table A-5.

Table A-5. S1 Header Record

Field	S-Record Entry			Description	
Type	S1			S-record type S1, indicating a code/data record to be loaded/verified at a two-byte address	
Record Length	13			Hexadecimal 13 (decimal 19), indicating 19 character pairs, representing 19 bytes of binary data, follow.	
Address	0000			Four-character two-byte address field; hexadecimal address 0000, indicates location where the following data is to be loaded.	
Code/Data	Opcode			Instruction	
	28	5F		BHCC	\$f0161
	24	5F		BCC	\$0163
	22	12		BHI	\$0118
	22	6A		BHI	\$0172
	00	04	2	BRSE	0, \$04, \$012F
	29	00	4	T	\$010D
	08	23		BHCS	4, \$23, \$018C
			7	BRSE	
				T	
Checksum	2A			Checksum of the first S1 record	

The 16 character pairs shown in the code/data field of Table A-5 are the ASCII bytes of the actual program.

The second and third S1 code/data records each also contain \$13 (19) character pairs and are ended with checksum 13 and 52, respectively. The fourth S code/data record contains 07 character pairs and has a checksum of 92.

A.5.3 The S9 Termination Record

The S9 termination record is described in Table A-6.

Table A-6. S-9 Header Record

Field	S-Record Entry	Description
Type	S9	S-record type S9, indicating a termination record
Record Length	03	Hexadecimal 04, indicating three character pairs (three bytes) follow
Address	0000	Four-character two-byte address field, zeroes
Code/Data		There is no code/data in a S9 record
Checksum	FC	Checksum of S9 record

A.5.4 ASCII Characters

Each printable ASCII character in an S-record is encoded in binary. Table A-6 gives an example of encoding for the S1 record. The binary data is transmitted during a download of an S-record from a host system to an 9- or 16-bit microprocessor-based system.

APPENDIX B

SUPPORT INFORMATION

B.1 OVERVIEW

This appendix provides technical support information for the M68ICS05C In-Circuit Simulator Kit, including:

- Functional description of the kit
 - Emulation
 - Programming
- Troubleshooting the Quick Start
- Troubleshooting the Programmer
- Schematic diagrams
- Parts List
- Board layout diagram

B.2 FUNCTIONAL DESCRIPTION OF THE KIT

The M68ICS05C pod consists of two components:

- C emulator
- 705C Programmer (including V_{PP} generation)

B.2.1 The Emulator

The core of the emulation component of the pod U4 is the MC68HC705C8 device. This MCU provides the required input/output information that lets the host computer simulate code, performing all functions except for maintaining port values. The internal EPROM in the C8 device runs a program which generates the appropriate port values.

The ICS05CW software on the host computer lets the host computer become a simulator. When the ICS requires port data, the computer requests the data through the host's serial connection to the C8 device. The C8 responds by sending the data to the host via the serial connection. It is this arrangement that lets the ICS simulator interface with the real world.

The M68ICS05C pod's 7.37-MHz crystal provides a clock signal for the C8 device. The clock runs the device at a 3.68-MHz bus rate. Note that the simulation speed will be less than the bus rate, because the host computer is the simulator.

NOTE

The C8 device differs from the emulated C device in that it does not have programmable pull-ups. Accordingly, the M68ICS05C pod has external pull-up resistors, which you can select using jumper headers W4 through W11. To disable the pull-ups, remove the fabricated jumpers from the corresponding headers.

B.2.2 Programming

In addition to controlling the input and output port signals, the C8 MCU also controls the programming of the C devices.

NOTE

To program a 705C device, the EPROM of the device must first be erased.

Programming begins with the initialization sequence:

- The host computer sends signals to the C8 device to initiate the programming sequence, then releases the RESET line.
- The host computer then sends data to the 705C device through the C8.
- The 705C device self-programs its EPROM array using the data downloaded by the host computer.
- The pod's MC34063 (U3) device generates the programming voltage (16.5 volts), controlled at the programming socket by the switch S1 (the Programmer software prompts you to turn switch S1 on or off as appropriate). In the case of the 705C, this programming voltage is used only to put the P device in the programming mode. The C device contains an internal charge pump that supplies internal V_{PP} .

B.3 TROUBLESHOOTING THE QUICK START

If you should experience difficulties quick-starting your kit using the procedure outlined in paragraph 1.7, follow these steps:

1. If the 705C8 part (at board location U4) is a windowed device, make certain that a black opaque label covers the window.
2. Make sure that no hardware security key or other devices are attached to the serial port.

3. Make sure that the serial cable is correctly attached to the pod, and to the correct serial port on the host computer.
4. Check the power supply: first make sure that the pod is not connected to the power supply, then measure the power to confirm that it produces 5 volts. Make sure the power connector is securely attached. You can measure this voltage with a voltmeter's ground connection to the tab of U1 (7805), and the U1's output pin (the pin located closest to R1). This voltage should measure $\pm 5V$ (5%).
5. With the pod still disconnected, measure the voltage at the output of U1; if it is less than 5 volts:
 - a. Verify that your power supply is properly plugged into an active wall socket.
 - b. Verify that the power supply is not being current limited, but providing 9 volts to the board. You can measure the voltage at the opposite pin of U1 (located closest to the edge of the board).
 - c. Remove the C8 part. If the voltage at U1 climbs to 5 volts, the C8 may be defective. Remove the U5 part.
 - d. If the voltage is still below 5 volts with both the U4 and U5 removed, the board may be defective.
 - e. Call Motorola Board Repair (800-451-3464) to arrange for replacement.
6. If you measure 5 volts at U1 when the C8 part is installed, measure the voltage between VDD (pin 3) and VSS (pin 20) of the C8 part at U4. If the level is not also 5 volts, check for a bent pin or other structural problem with the socket or the board trace. If you can find no structural problem, call Motorola Board Repair to arrange for a board replacement.
7. If there are 5 volts between pins 3 and 20, use an oscilloscope to check the output of pin 39 of the device at U4. Set the oscilloscope to 0.5 (sec per division). You should observe approximately 3.5 cycles per division; this corresponds to a 7.36 MHz signal. If you do not get this result, it may be due to any of these problems:
 - a. Bad crystal at location Y1
 - b. Bad resistor at location R11
 - c. Bad capacitor at location C14 or C15
 - d. Bad C8 part at location U4
 - e. Bad socket at location U4
 - f. Broken trace on pod
 - g. Cold solder joint on pod
8. If, after checking the board parts, you still have not found the problem, measure the signals on the clock and serial input pins (2, 3) of connector P2. There should be

activity on these pins when you enter the POD command. If there is no activity on these pins, check for the following faults:

- a. Bad C8 part at location U4
 - b. Bad socket at location U4
 - c. Bad connector at location J2
 - d. Broken trace on pod
 - e. Cold solder joint on pod
9. If the problem persists, check LED at DS1: remove the C8 device, then short socket U5 pin 4 to ground. If the LED does not light, it may be defective or installed backwards.
 10. If during the quick-start, the LED at DS1 still does not flash, consult a field application engineer from your Motorola distributor or sales office.
 11. If during the quick-start, the LED at DS1 continues to flash, check that U5 pin 12 goes low when you push switch S4. If it does not go low, ohm out resistor R18 and switch S4. Consult Motorola Board Repair if needed.

B.4 TROUBLESHOOTING THE PROGRAMMER

If you should experience difficulties when programming a 705C part with which you can perform other simulator functions, follow these steps:

1. Test the sockets XU6, XU7, and XU8:
 - a. Verify that no part is in socket XU6, XU7, or XU8.
 - b. Verify that the voltage on pin 40 of socket XU6 is 5 volts. If not, the socket may be bad or there may be a bad pod trace.
2. Calibrate V_{PP} : If pin 3 has 5 volts, calibrate the V_{PP} using these steps:
 - a. Turn switch S2 ON.
 - b. Measure the signal on pin 2 of socket XU6.
 - c. Adjust potentiometer VR1 until your meter reads 12.5 ± 0.5 volts.
 - d. Turn switch S2 to OFF and disconnect VDD power
3. Retest programmer:
 - a. In the ICS, enter the PROGRAM command and follow the programming instructions that appear on the screen.
 - b. Before reinserting the 705C device in socket XU6, XU7, or XU8, make sure that its erase window is covered.

Use the oscilloscope to measure V_{PP} as the 705P device is being programmed; the V_{PP} should not drop below 12.5 volts. If the V_{PP} drops below 12.5 volts, either or both the 705C device or the MC34063 device may be defective.

To replace defective parts, call Motorola Board Repair (800-451-3464).

B.5 SCHEMATIC DIAGRAM AND PARTS LIST

Figures B-1 and B-2 diagram the M68ICS05C logic components. Table B-1 itemizes and describes the M68ICS05C parts list.

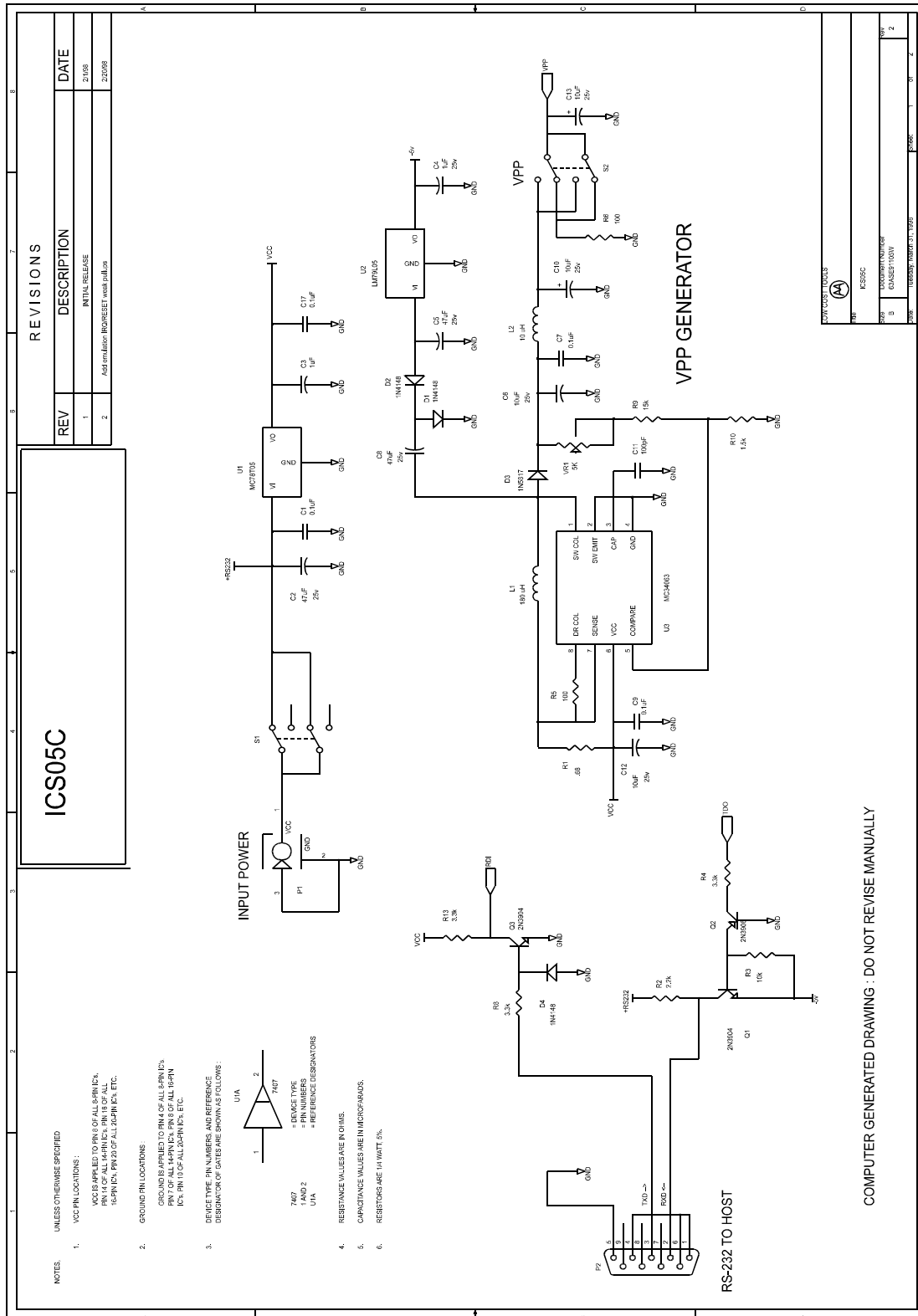

Figure B-1. M68ICS05C Schematic Diagram (Sheet 1 of 2)

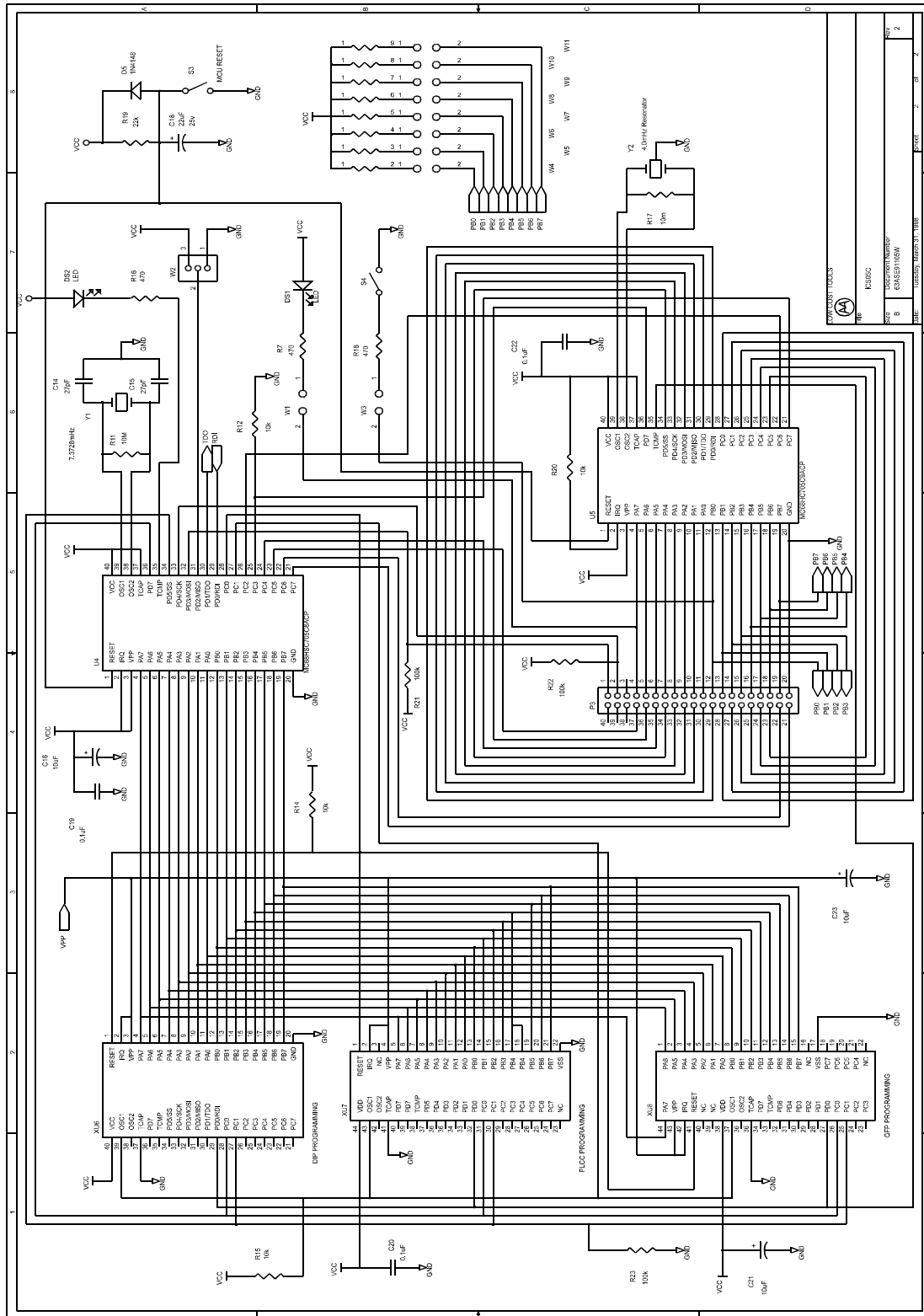

Figure B-2. M68ICS05C Schematic Diagram (Sheet 2 of 2)

Table B-1. M68ICS05C Parts List

Part Number	Description	Manufacturer	Reference Designator
EC05ZD0104K	CAP, .1uF 10% 50V	THOMSON	C1, C7, C9, C17, C19, C20, C22
21RD160	CAP, 100pF 10% 25V	MALLORY	C11
140-CD50S2-027J	CAP, 27pF 10% 25V	XICON	C14, C15
RE22MF25V	CAP, 22uF 10% 25V ELECTROLYTIC	XICON	C18
RE47MF35V	CAP, 47uF 10% 35V ELECTROLYTIC	XICON	C2, C5, C8
ECS-F1VE105K	CAP, 1uF 10% 25V TANTALUM	PANASONIC	C3, C4
ECS-F1VE106K	CAP, 10uF 10% 25V TANTALUM	PANASONIC	C6, C10, C12, C13, C16, C21, C23
1N4148	DIODE	MOTOROLA	D1, D2, D4, D5
1N5817	DIODE, 1A 20V SCHOTTKY	MOTOROLA	D3
LN28RP	LED, T-1 3/4 RED DIFFUSED LED	PANASONIC	DS1, DS2
SFB181	IND, 180uH WW/W SLEEVE	WILCO	L1
IM-2-10.0	IND, CHOKE 10uH 10%	DALE	L2
PJ-002A	CONN, POWER JACK, MALE, 2.1mm	CUI	P1
24-326	CONN, DB9-FEMALE RA PCB MOUNT	KRISTA	P2
TSW-120-07-T-D	CONN, .23 IN, 20 X 2 HDR	SAMTEC	P3
2N3904	TRANSISTOR, NPN	MOTOROLA	Q1, Q3
2N3906	TRANSISTOR, PNP	MOTOROLA	Q2
RSS1R68JT50	RES, .68 ohm 5% 1W	KOA	R1
CF1/4152JT52	RES, 1.5K 5% 1/4W	KOA	R10
CF1/4106JT52	RES, 10M 5% 1/4W	KOA	R11, R17
CF1/4223JT52	RES, 22K 5% 1/4W	KOA	R19

Table B-1. M68ICS05C Parts List (continued)

Part Number	Description	Manufacturer	Reference Designator
CF1/4222JT52	RES, 2.2K 5% 1/4W	KOA	R2
CF1/4104JT52	RES, 100K 5% 1/4W	KOA	R21, R22, R23
CF1/4103JT52	RES, 10K 5% 1/4W	KOA	R3, R12, R14, R15, R19, R20
CF1/4332JT52	RES, 3.3K 5% 1/4W	KOA	R4, R8, R13
CF1/4101JT52	RES, 100 ohm 5% 1/4W	KOA	R5, R6
CF1/4471JT52	RES, 470 ohm 5% 1/4W	KOA	R7, R16, R18
CF1/4153JT52	RES, 15K 5% 1/4W	KOA	R9
4610X-101-104	RNET, 100K 10 PIN SIP, Pin 1 common	BOURNS	RN1
MHS-222	SWITCH, SLIDE DPDT	ALCO	S1, S2
EVQ-QS205K	SWITCH, PUSHBUTTON SPST	PANASONIC	S3, S4
MC78T05CT	IC, VOLTAGE REGULATOR	MOTOROLA	U1
MC79L05ACP	IC, VOLTAGE REGULATOR	MOTOROLA	U2
MC34063AP1	IC, DC/DC CONVERTER	MOTOROLA	U3
M07D001	IC, MCU, MC68HSC705C8ACP	MOTOROLA	U4
M09D000	IC, MCU, MC68HSC705C9ACP	MOTOROLA	U5
3386T-5K	RES, VARIABLE, 5K 10% 1/2W	BOURNS	VR1
TSW-102-07-T-S	CONN, .23 IN. 2 X 1 HDR	SAMTEC	W1, W3
24-872	CONN, SHUNT 2 POS	KRISTA	W1-W11
TSW-103-07-T-S	CONN, .23 IN. 3 X 1 HDR	SAMTEC	W2
TSW-108-07-T-D	CONN, .23 IN. 8 X 2 HDR	SAMTEC	W4-W11

Table B-1. M68ICS05C Parts List (continued)

Part Number	Description	Manufacturer	Reference Designator
ICE-406-S-TG	40 PIN MACHINED DIP SOCKET .600"	ROB NUGENT	XU4,XU5
613-7400316	40 PIN TEST LIF SOCKET .6" SPACING	WELLS CTI	XU6
IC120-0444-306	44 PIN PLCC SOCKET	YAMAICHI	XU7
IC51-0444-467	44 PIN QFP SOCKET	YAMAICHI	XU8
ECS-73-20-4	CRYSTAL, 7.3728 MHZ	ECS	Y1
ZTT-4.00MG	CERAMIC RESONATOR, 4.0 MHZ w CAPS	ECS	Y2
4009-00-5072	BUMPER PAD, BLK	FASTEX	
84-RE91105W REV A	PRINTED WIRING BOARD	WESTAK	

B.6 BOARD LAYOUT

Figure B-3 shows the M68ICS05C board layout and component locations.

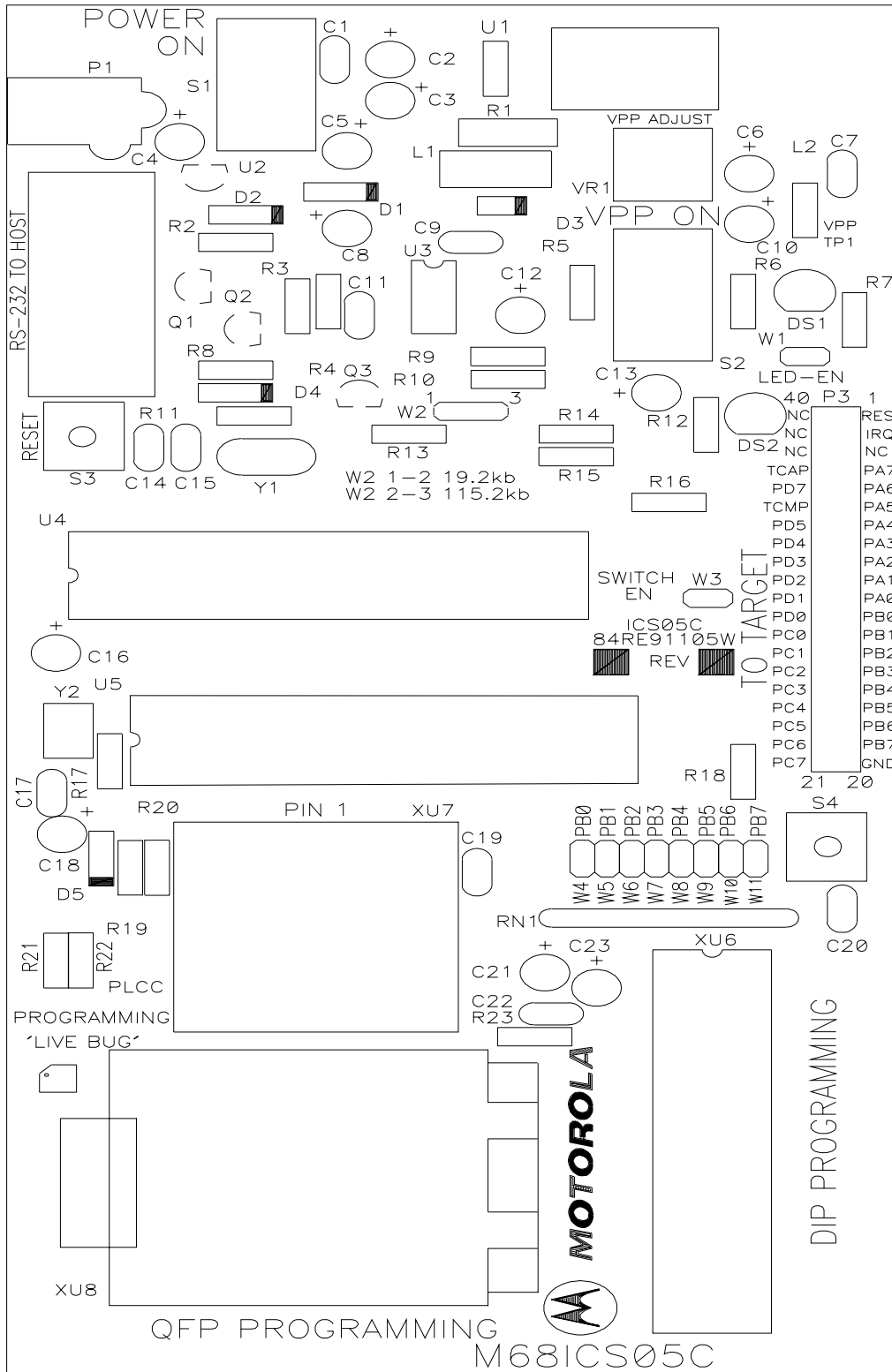

Figure B-3. M68ICS05C Board Layout

GLOSSARY

8-bit MCU	A microcontroller whose data is communicated over a data bus made up of eight separate data conductors. Members of the M68HC05 family of microcontrollers are 8-bit MCUs.
A	Abbreviation for the accumulator of the M68HC05 MCU.
accumulator	An 8-bit register of the M68HC05 CPU. The contents of this register may be used as an operand of an arithmetic or logical instruction.
assembler	Software program that translates source code mnemonics into opcodes that can then be loaded into the memory of a microcontroller.
assembly language	Instruction mnemonics and assembler directives that are meaningful to programmers and can be translated into an object code program that a microcontroller understands. The CPU uses opcodes and binary numbers to specify the operations that make up a computer program. Humans use assembly language mnemonics to represent instructions. Assembler directives provide additional information such as the starting memory location for a program. Labels are used to indicate an address or binary value.
ASCII	American Standard Code for Information Interchange. A widely accepted correlation between alphabetic and numeric characters and specific 7-bit binary numbers.
breakpoint	During debugging of a program, it is useful to run instructions until the CPU gets to a specific place in the program, and then enter a debugger program. A breakpoint is established at the desired address by temporarily substituting a software interrupt (SWI) instruction for the instruction at that address. In response to the SWI, control is passed to a debugging program.
byte	A set of exactly eight binary bits.
C	Abbreviation for “carry/borrow” in the condition codes register of the M68HC05. When adding two unsigned 8-bit numbers, the C bit is set if the result is greater than 255 (\$FF).

CCR	Abbreviation for “condition codes register” in the M68HC05. The CCR has five bits (H, I, N, Z, and C) that can be used to control conditional branch instructions. The values of the bits in the CCR are determined by the results of previous operations. For example, after a load accumulator (LDA) instruction, Z will be set if the loaded value was \$00.
clock	A square wave signal that is used to sequence events in a computer.
command set	The command set of a CPU is the set of all operations that the CPU knows how to perform. One way to represent an instruction set is with a set of shorthand mnemonics such as LDA meaning “load A.” Another representation of an instruction set is the set of opcodes that are recognized by the CPU.
condition codes register	The CCR have five bits (H, I, N, Z, and C) that can be used to control conditional branch commands. The values of the bits in the CCR are determined by the results of previous operations. For example, after a load accumulator (LDA) instruction, Z will be set if the loaded value was \$00.
CPU	Central Processor Unit. The part of a computer that controls execution of instructions.
CPU cycles	A CPU clock cycle is one period of the internal bus-rate clock. Normally this clock is derived by dividing a crystal oscillator source by two or more so the high and low times will be equal. The length of time required to execute an instruction is measured in CPU clock cycles.
CPU registers	Memory locations that are wired directly into the CPU logic instead of being part of the addressable memory map. The CPU always has direct access to the information in these registers. The CPU registers in an M68HC05 are A (8-bit accumulator), X (8-bit index register), CCR (condition codes register containing the H, I, N, Z, and C bits), SP (stack pointer), and PC (program counter).
cycles	See CPU cycles
data bus	A set of conductors that are used to convey binary information from a CPU to a memory location or from a memory location to a CPU; in the M68HC05, the data bus is 8-bits.

development tools	Software or hardware devices used to develop computer programs and application hardware. Examples of software development tools include text editors, assemblers, debug monitors, and simulators. Examples of hardware development tools include simulators, logic analyzers, and PROM programmers. An in-circuit simulator combines a software simulator with various hardware interfaces.
EPROM	Erasable, Programmable Read-Only Memory. A non-volatile type of memory that can be erased by exposure to an ultra-violet light source. MCUs that have EPROM are easily recognized by their packaging: a quartz window allows exposure to UV light. If an EPROM MCU is packaged in an opaque plastic package, it is termed a “one-time-programmable” OTP MCU, since there is no way to erase and rewrite the EPROM.
H	Abbreviation for “half-carry” in the condition codes register of the M68HC05. This bit indicates a carry from the low-order four bits of an 8-bit value to the high-order four bits. This status indicator is used during BCD calculations.
I	Abbreviation for “interrupt mask bit” in the condition codes register of the M68HC05.
index register	An 8-bit CPU register in the M68HC05 that is used in indexed addressing mode. The index register (X) can also be used as a general purpose 8-bit register (in addition to the 8-bit accumulator).
input-output (I/O)	Interfaces between a computer system and the external world: for example, a CPU reads an input to sense the level of an external signal and writes to an output to change the level on an external signal.
instructions	Instructions are operations that a CPU can perform. Instructions are expressed by programmers as assembly language mnemonics. A CPU interprets an opcode and its associated operand(s) as an instruction.
listing	A program listing shows the binary numbers that the CPU needs alongside the assembly language statements that the programmer wrote. The listing is generated by an assembler in the process of translating assembly language source statements into the binary information that the CPU needs.
MCU	Microcontroller: a complete computer system including CPU, memory, clock oscillator, and I/O on a single integrated circuit.

memory location	In the M68HC05, each memory location holds one byte of data and has a unique address. To store information into a memory location the CPU places the address of the location on the address bus, the data information on the data bus, and asserts the write signal. To read information from a memory location the CPU places the address of the location on the address bus and asserts the read signal. In response to the read signal, the selected memory location places its data onto the data bus.
N	Abbreviation for “negative,” a bit in the condition codes register of the M68HC05. In twos-complement computer notation, positive signed numbers have a zero in their MSB and a negative numbers have a one in their MSB. The N condition code bit reflects the sign of the result of an operation. After a load accumulator instruction, the N bit will be set if the MSB of the loaded value was a one.
object code file	A text file containing numbers that represent the binary opcodes and data of a computer program. An object code file can be used to load binary information into a computer system. Motorola uses the S-record file format for object code files.
operand	An input value to a logical or mathematical operation.
opcode	A binary code that instructs the CPU to do a specific operation in a specific way. The M68HC05 CPU recognizes 210 unique 8-bit opcodes that represent addressing mode variations of 62 basic instructions.
OTPROM	A non-volatile type of memory that can be programmed but cannot be erased. An OTPROM is an EPROM MCU that is packaged in an opaque plastic package, it is called a “one-time-programmable” MCU because there is no way to expose the EPROM to a UV light.
PC	Abbreviation for program counter CPU register of the M68HC05.
program counter	The CPU register that holds the address of the next instruction or operand that the CPU will use.
RAM	Random Access Memory. Any RAM location can be read or written by the CPU. The contents of a RAM memory location remain valid until the CPU writes a different value or until power is turned off.

registers	Memory locations that are wired directly into the CPU logic instead of being part of the addressable memory map. The CPU always has direct access to the information in these registers. The CPU registers in the M68HC05 are A (8-bit accumulator), X (8-bit index register), CCR (condition codes register containing the H, I, N, Z, and C bits), SP (stack pointer), and PC (program counter). Memory locations that hold status and control information for on-chip peripherals are called I/O and control registers.
reset	Reset is used to force a computer system to a known starting point and to force on-chip peripherals to known starting conditions.
S-record	A Motorola standard format used for object code files.
simulator	A computer program that copies the behavior of a real MCU.
source code	See source program
SP	Abbreviation for stack pointer CPU register in the M68HC05 MCU.
source program	A text file containing instruction mnemonics, labels, comments, and assembler directives. The source file is processed by an assembler to produce a composite listing and an object file representation of the program.
stack pointer	A CPU register that holds the address of the next available storage location on the stack.
V_{DD}	The positive power supply to a microcontroller (typically 5 volts dc).
V_{SS}	The 0 volt dc power supply return for a microcontroller.
Word	A group of binary bits. Some larger computers consider a set of 16 bits to be a work but this is not a universal standard.
X	Abbreviation for “index register,” a CPU register in the M68HC05.
Z	Abbreviation for “zero,” a bit in the condition codes register of the M68HC05. A compare instruction subtracts the contents of the tested value from a register. If the values were equal, the result of this subtraction would be zero so the Z bit would be set; after a load accumulator instruction, the Z bit will be set if the loaded value was \$00.

-
- MACRO directive, 5-12
 - macros, 5-12
 - object files, 6-3
 - outputs, 3-1, 5-5
 - pseudo-operations, 5-16
 - quick-start, 1-6
 - sample project, 8-1
 - shortcut, 5-3
 - substituting, 3-1, 5-6, 5-20
 - user interface, 5-2
 - window, 1-6, 5-2, 5-4
 - CC value, 5-14
 - CCR command, 7-25
 - CF command, 7-24
 - changes
 - bases, 6-11
 - CPU information, 6-15
 - restoring, 4-15
 - reverses, 4-14
 - save options, 4-19
 - saving, 4-13
 - software startup, 6-5
 - checksum, A-1
 - child windows, 4-2
 - chip logic, representing, 6-17
 - Chip Window, 6-17
 - CHIPINFO, 1-2
 - clearing
 - Clear All, 6-11
 - markers, 4-6
 - variables, 6-11
 - CLEARMAP command, 7-27
 - CLEARSYMBOL command, 7-28
 - client windows
 - WinIDE, 4-2
 - clock signal, B-2
 - closing files
 - current project file, 4-18
 - WinIDE, 4-13
 - code timing, 6-18
 - Code Window, 6-7, 6-8, 7-87
 - code/data, A-1
 - Color, 4-29
 - column numbers, 4-3
 - command
 - buffer, 6-25
 - sequences, 1-2
 - syntax, 7-2
 - command-line
 - entering commands, 6-13
 - parameters, 4-6
 - comments, 5-8
 - communications, pod-to-host, 1-2, 3-3
 - Compact, 3-3
 - compiler
 - customized, 3-2
 - options, 4-17
 - third party, 6-3
 - types, 4-23
 - components
 - ICS05CW, 1-1
 - conditional assembly, 5-11
 - configuring external programs in WinIDE, 4-22
 - Confirm command line, 4-25, 4-28
 - context-sensitive Help, 1-2
 - copying text, 4-15
 - counting
 - breakpoints, 6-22
 - cycles, 6-18
 - CPU
 - registers, 6-15
 - results, 6-18
 - Window, 6-15
 - Create Backup, 4-21
 - creating
 - new file
 - WinIDE, 4-11
 - script files, 6-4
 - source files, 4-14
 - Currently edited filename, 4-20
 - customizing environments, 1-6
 - cycles
 - adding, 5-9
 - counter, 5-14
 - counting, 6-18
 - Cycle Adder, 5-9
 - Cycle Cntr, 5-14
 - CYCLES command, 7-30
 - Cycles Window, 6-18
 - field in listing file, 6-4
 - including information in list file, 4-24
 - CYCLES command, 7-30
- ## D
- DASM command, 7-31
 - DDRA command, 7-32
 - DDRB command, 7-33
 - debugger
 - customized, 3-2
 - options, 4-17
 - routines, 6-33
 - third-party, 4-22
 - debugging commands
 - command set, 7-1
 - description, 7-1
 - detailed listing, 7-9
 - entering, 6-25
 - summary, 7-3, 7-4
 - syntax, 7-2
 - deleting
 - breakpoint, 6-22
 - text, 4-16
 - variables, 6-11
 - desktop information, 4-17
 - direct addressing mode, 5-17
 - Direction, 4-30
 - displaying

Code Window Shortcut menu, 6-8
source code, 6-7
Stack Window:, 6-18
Trace Window, 6-20
Variables Shortcut menu, 6-10
distribution media, 3-2
download files, 6-24
drive space, 1-2
DUMP command, 7-34

E

editing
breakpoints, 6-22
options, WinIDE, 4-14, 4-20
source files, 4-14
text, 3-1
editor
description, 1-2, 3-1
files, saving, 4-20
options, 4-20
options, WinIDE, 4-14
Effects, 4-29
emulator, B-1
environment
building, 4-3
customizing, 1-6
Environment Menu, 1-4, 4-17
Environment Settings Dialog, 1-4
options, 4-16
path, 4-22
settings, 4-16, 4-17
storing settings, 4-16
EPROM, 1-1, 1-2
EQU, 5-16
equate directive, 5-16
errors
files, 4-26, 6-3
format, 4-26
messages, assembler, 5-18
output batch file, 4-26
EVAL command, 7-35
examples
changing number format, 6-11
conditional assembly directives, 5-11
labels, 5-15
listing table, 5-15
macro directive, 5-12
S-records, A-3
EXE 1 (Debugger) tab, 4-26
EXE 2 (Programmer) tab, 4-26
EXE Path, 4-27
executable options, 4-17
executing
source code, 6-8
Exit Application, 4-20
EXIT command, 7-36
exiting
application, 4-20

WinIDE, 4-11, 4-14
Expand Includes in List, 4-24
Expand Macros in Listing, 4-24
extended addressing mode, 5-17
extension
specifying, 4-6
External Program 1 toolbar button, 4-5
external programs, 4-26
configuring in WinIDE, 4-22
running, 4-22
external pull-down resistors, B-2

F

FCB directive, 5-17
FDB directive, 5-17
fields
listing files, 6-4
file options
ICS, 6-28
WinIDE, 4-11
filename
storing as parameter, 4-19
filename parameter, 4-6
files
ASCII, 3-2, 6-4
assembler, 3-3
assembly, 3-2
ICS, 3-3
ICS05CW, 3-3
listing, 8-4
map, 3-2
object code, 3-2
printing, 4-13
programmer download, 6-24
programmer upload, 6-24
S19, 3-2, 6-3
saving, 4-12, 4-20
script, 6-4
startup, 6-6
WinIDE, 3-3
filetypes
WinIDE, 4-4
Find Dialog
WinIDE, 4-29
Find Next button, 4-30
Find what textbox, 4-30
Fixed Tabs, 4-22
Font, 4-28
font settings, 4-16
Font Style, 4-28
Form Constant Byte, 5-17
Form Double Byte, 5-17

G

G command, 7-37
General Editor, 1-5
General Editor options, 4-17

General Editor Tab, 4-20, 4-21
 General Environment, 1-5
 General Environment options, 4-17
 General Environment Tab, 4-19
 General Options, 4-21
 Give user option to save each file, 4-20
 GO command, 7-37
 GOMACRO command, 7-38
 Gotil Address at Cursor, 6-8
 GOTIL command, 7-39
 GOTOCYCLE command, 7-40

H

H command, 7-41
 hardware
 installation, 2-1
 requirements, 1-2
 specifications, 1-3
 Help, 1-2
 HELP command, 7-42
 HEX format, 6-12
 hexadecimal number format, 6-10
 hexadecimal values
 field in listing file, 6-4
 humidity, 1-3

I

I command, 7-43
 I/O, 1-1
 I/O pins, 6-17
 ICS, 6-1
 Execute Menu, 6-33
 Execute Options, 6-33
 File Menu, 6-28
 File options, 6-28
 files, 3-3
 menu options
 Close Logfile, 6-32
 Exit, 6-32
 Go, 6-34
 Load S19 File, 6-29
 Multiple Step, 6-34
 Open Logfile, 6-31
 Open Window, 6-35
 Play Macro, 6-30
 Record Macro, 6-30
 Reload Desktop, 6-36
 Reload Last S19, 6-29
 Reset Processors, 6-33
 Save Desktop, 6-36
 Stop, 6-34
 Stop Macro, 6-31
 starting, 6-5
 Window Options, 6-35
 windows
 Breakpoint Window, 6-21
 Chip Window, 6-17

Code Windows, 6-7
 CPU Window, 6-15
 CPU Wndow, 6-15
 Cycles Window, 6-18
 Memory, 6-12
 Memory Window, 6-12
 Personality EEPROM Window, 6-20
 Programmer Window, 6-23
 Stack Window, 6-18, 6-19
 Status Window, 6-13
 Trace Window, 6-20
 Variables Window, 6-9, 6-10
 ICS05CW, 3-2
 ICS05CW, 1-1, 1-2, 1-4, 1-6
 Components, 1-1
 features, 1-2
 ICS05CW command argument types, 7-3
 ICS05CW command overview, 7-4, 7-5, 7-6, 7-7, 7-8, 7-9
 ICS05CW command set, 7-1
 ICS05CW COMMAND SYNTAX, 7-2
 ICS05CW commands, 6-13
 ICS05CW simulation speed, 6-1
 If Modified files exist just prior to external program
 execution:, 4-20
 In-Circuit Simulator, 1-1
 user interface, 6-1
 INCLUDE, 8-3
 INCLUDE directive, 5-11
 included files
 expanding, 4-24
 using, 4-20
 indentation, 4-20
 INFO command, 7-44
 initialization sequence, B-2
 INPUTA command, 7-45
 INPUTB command, 7-46
 INPUTS command, 7-47
 installation
 compact, 3-3
 typical, 3-3
 installing
 ICS05CW software, 3-2
 M68HC705J1A pod, 2-1
 M68ICS05C pod, 2-1
 software, 3-1, 3-2
 INT command, 7-48
 integrated development environment, 1-1
 internal charge pump, B-2
 internal registers, 6-15
 Interrupt Stack, 6-19
 IRQ command, 7-48

J

jumper headers, B-2

L

labels, 5-12, 5-14, 5-15, 6-10

- LF command, 6-5
- line count, 5-14
 - field in list file, 6-4
- line numbers, 4-3
- lines
 - total, 4-3
- listing directives, 5-13
- listing files, 4-4, 4-24, 5-6, 5-13, 6-4
 - fields, 5-14
- Listing Options, 4-24
- listing table, 5-14
- LISTOFF command, 7-49
- LISTON command, 7-50
- LOAD command, 7-51
- Load S19 File, 6-29
- LOADDESK command, 7-52
- loading
 - map files, 6-29
- LOADMAP command, 7-53
- Log Files, 6-5
 - opening, 6-31
 - specifying, 6-31
- LOGFILE command, 6-5

M

- M68HC05 MCUs, 6-19
- M68HC705C, 1-1, 1-2
- M68ICS05C, 1-1, 1-2, 1-3, 1-4, 2-1, 4-4, 6-1, 6-23, 7-67,
 - B-1, B-2
 - board layout, B-10
 - board repair, B-5
 - features, 1-2
 - parts list, B-8, B-9, B-10
 - pod, 4-4
 - schematic diagram, B-5, B-6, B-7
 - support information, B-1
- machine cycles, 5-14
- MACRO command, 7-55
- MACRO directive, 5-12
- MACROEND command, 7-56
- macros
 - expanding, 4-24
 - forward referencing, 5-13
 - jumping from, 5-13
 - recording, 6-30
 - running, 6-30
 - stopping, 6-31
- MACROSTART command, 7-57
- Main Filename, 4-20
- Main Filename option
 - WinIDE, 4-25
- managing
 - Code Window contents, 6-8
 - open windows, 4-31
 - project information, 4-16
 - variables, 6-10
 - WinIDE files, 4-11
- map files, 3-2, 5-6

- loading, 6-29
- Marker Sub-menu, 4-6
- markers
 - clearing, 4-6
 - moving, 4-5, 4-6
 - setting, 4-5, 4-6
 - using, 4-5
- Match Case, 4-30, 4-31
- Match Whole Word Only, 4-30
- MC68HC705C8 device, B-1
- MCUs, 1-1
- MD command, 7-58
- media, 3-2
- memory, 1-2
 - address, 5-14, A-1
 - map, 1-2, 6-12
 - modifying, 6-12
 - viewing, 6-12
- Memory Window, 6-12
 - Shortcut menu, 6-12
- menu options
 - WinIDE, 4-9, 4-10, 6-27, 6-28
- menus
 - WinIDE, 4-9
- microcontrollers, 1-1
- MM command, 6-12, 7-59
- modifying
 - memory, 6-12
 - memory bytes, 6-12
- Motorola Board Repair, B-5

N

- N command, 7-60
- navigating
 - in IDE environment, 4-5
 - in sour files, 4-5
- No Trace Available, 6-20
- NOBR command, 7-61
- NOMAP command, 7-62
- non-P&E compiler, 4-23
- NOSYMBOL command, 7-62
- number format, 6-10

O

- object files, 3-2, 5-5
- opcode mnemonics, 5-7
- Open File dialog
 - WinIDE, 4-12
- Open Logfile, 6-31
- Open Project, 1-4
- opening
 - log files, 6-31
 - WinIDE files, 4-12
- operating system, 1-2
- Options, 4-27
- ORG, 5-17
- originate directive, 5-17

Other Assembler/Compiler, 4-25
 Output Debug File, 4-23
 Output Listing File, 4-23
 Output S19 Object, 4-23

P

P&E compiler, 4-23
 P1, 2-1
 P2, 1-4, 2-1
 parameters
 command-line, 4-6
 parts list, B-8, B-9, B-10
 pasting text, 4-16
 path, EXE, 4-22
 PC command, 7-63
 Pick Window, 6-23
 PIF files, 4-22
 pin-out, 1-2
 pins, 6-17
 Play Macro, 6-30
 pod, 1-1, 1-2, 1-4, 6-17
 communications, 3-3
 connector P2, 1-4
 installation, 2-1
 POD command, 7-64
 PORTA command, 7-65
 PORTB command, 7-66
 ports
 data, B-1
 serial, 1-2
 power
 requirements, 1-3
 supply, connecting, 1-4
 switch, 2-1
 PPF files, 4-17
 printing, 4-11, 4-13
 processor cycles
 viewing number, 6-18
 PROG05P3 Programmer Pick Window, 6-23
 program counter
 setting, 6-8
 Program Manager, 3-3
 Programmer Files Window, 6-24
 Programmer Status Window, 6-23
 Programmer Window, 6-23
 programming C devices
 control, B-2
 equipment, 4-22
 troubleshooting, B-4
 voltage, B-2
 project
 environment, 4-3, 4-16
 files, 4-17
 name, 4-16
 sample, 8-1
 saving, 4-18
 Project Files, 6-2
 PRTA command, 7-65

PRTB command, 7-66
 pseudo operations, 5-16

Q

quick start, 1-4
 Quick Start troubleshooting, B-2
 QUIT command, 7-36

R

R command, 7-70
 RAM, 1-2
 Real Tabs, 4-22
 record length, A-1
 Record Macro, 6-30
 record type, A-1
 recording macros, 6-30
 Recover Error from Compiler, 4-25
 Redo
 WinIDE, 4-15
 REG command, 7-71
 registers, 1-2
 Reload Last S19, 6-29
 REM command, 7-72
 removing
 breakpoints, 6-22
 Replace Dialog, 4-30
 requirements
 hardware, 1-2
 host, 6-2
 host computer, 1-2
 software, 1-2
 Reserve Memory Byte, 5-17
 reset
 microcontroller, 6-33
 switch, 2-1
 RESET command, 7-73
 RESETGO command, 7-74
 reversing changes, 4-14
 RMB directive, 5-17
 RS-232 serial connector, 2-1
 RTI, 6-18
 RTS, 6-18
 Run, 3-2
 RUN command, 7-37
 running
 macros, 6-30

S

S1, 2-1
 S19 files, 3-2, 6-3
 S3, 2-1
 Sample, 4-29
 sample project, 8-1
 Save all files before running, 4-28
 Save files before Assembling, 4-24, 4-25

-
- SAVEDESK command, 7-75
 - saving
 - changing options, 4-19
 - files, 4-12
 - projects, 4-18
 - Saving the Project, 4-20
 - schematic diagram, B-5, B-6, B-7
 - scratch pad files, 6-5
 - SCRIPT, 1-2, 4-29
 - Script Files, 6-4
 - Search Menu
 - WinIDE, 4-29
 - Select Source Module, 6-9
 - selecting text, 4-16
 - serial port
 - connector, 1-4, 2-1
 - use, 1-2
 - Set Base Address, 6-8, 6-12
 - Set Base Address to PC, 6-9
 - Set PC at Cursor, 6-8
 - setting
 - base address, 6-8
 - breakpoints, 6-8
 - markers, 4-5, 4-6
 - program counter, 6-8
 - setup, 3-2
 - ICS05CW software, 1-4
 - Setup Environment option, 1-4
 - Setup Fonts Dialog, 4-28
 - Show as HEX and ASCII, 6-12
 - Show as HEX Only, 6-12
 - Show Assembler Progress, 4-24
 - Show Cycles in Listing, 4-24
 - Show Disassembly, 6-9
 - Show Source/Disassembly, 6-9
 - SHOWBREAKS command, 6-21, 7-76
 - SHOWCODE command, 7-77
 - SHOWTRACE command, 6-20, 7-79
 - simulation
 - mode, ICS05CW, 4-4
 - speed, 6-1
 - simulator, 1-2, 4-22
 - Size, 4-28
 - SLD map files, 6-29
 - Smart Tabs, 4-22
 - software
 - installation, 3-2
 - loading, 3-1
 - modifying startup, 6-5
 - requirements, 1-2
 - starting, 3-3
 - WinIDE, 1-1
 - Sound Bell on Error, 4-24
 - source code, 5-14
 - assembly mode, 6-8
 - disassembly mode, 6-8
 - editing, 3-1
 - executing, 6-8
 - files, 4-4
 - source files
 - creating, 4-14
 - editing, 4-14
 - preparing, 5-6
 - source window
 - WinIDE, 4-3
 - source-level debugging, 5-6
 - SP command, 7-81
 - specifications
 - hardware, 1-3
 - Specify project file to save Dialog, 4-18
 - specifying
 - ASCII constants, 5-8
 - speed
 - calculating, 6-2
 - simulation, 6-1
 - Split Bar, 4-36
 - Split Pointer, 4-36
 - S-records
 - content, A-1
 - creating, A-3
 - field contents, A-2
 - fields, A-1
 - overview, A-1
 - S0 header record, A-4
 - S0 record, A-4
 - S1 record, A-5
 - S9 record, A-6
 - termination record, A-6
 - types, A-2
 - SS command, 7-82
 - STACK command, 7-84
 - stack data interpretations, 6-19
 - stack pointer value, 6-18, 6-22
 - stack values
 - viewing, 6-18
 - Stack Window, 6-18, 6-19
 - displaying, 6-18
 - standalone mode, 6-5
 - Start Menu, 3-2, 3-3
 - starting
 - ICS, 6-5
 - ICS05CW, 1-4
 - software, 3-3
 - WinIDE, 4-4
 - startup files, 6-6
 - STARTUP.05P, 6-6
 - status bar
 - WinIDE, 4-3
 - Status Window, 6-13
 - command-line area, 6-13
 - message area, 6-13
 - STEP command, 7-83
 - STEPFOR command, 7-85
 - STEPTIL command, 7-86
 - Stop Macro, 6-31
 - storing
 - desktop information, 4-17
 - environment settings, 4-16

executable options, 4-17
 Strikeout, 4-29
 Subroutine Stack, 6-19
 switches

- compiler/assembler, 4-25
- DIP, 1-1
- power, 2-1
- reset, 2-1

 SYMBOL command, 6-10, 7-87
 symbol table, 5-15

- list file, 6-4

 system

- progress, 4-3
- requirements, 6-2
- status, 4-3

T

tab settings, 4-20, 4-22
 Tab Size, 4-22
 temperature

- operating, 1-3
- storage, 1-3

 text files, 4-4
 timing code, 6-18
 title bar

- WinIDE, 4-3

 Toggle Breakpoint at Cursor, 6-8
 toolbar

- WinIDE, 4-7, 6-25

 TRACE command, 6-20, 7-88
 Trace Window, 6-20

- displaying, 6-20

 tracing

- trace buffer, 6-20
- trace buffer slot numbers, 6-20
- viewing, 6-20

 transformer

- connecting, 1-4

 troubleshooting

- programmer, B-4
- Quick Start, B-2

 TYPE, 4-23, 4-27
 Typical, 3-3

U

U2, 6-23
 Underline, 4-29
 Understanding Small Microcontrollers, 1-2
 Undo

- WinIDE, 4-14

 upload files, 6-24
 UPLOAD_SREC command, 7-89
 Upon Exiting WinIDE, 4-19
 user interface

- ICS, 6-1
- WinIDE, 4-1

 user manual, 1-2

V

values on stack, 6-18
 VAR command, 7-90
 variables

- adding, 6-10
- choosing types, 6-11
- clearing, 6-11
- deleting, 6-11
- managing, 6-10

 Variables Window, 6-9, 7-87

- Shortcut menu options, 6-10

 vector, 1-2
 VERSION command, 7-91
 viewing

- breakpoints, 6-21
- command results, 6-13
- CPU information, 6-15
- instructions during tracing, 6-20
- memory, 6-12

W

WAIT command, 7-92
 Wait for Assembler Result, 4-24
 Wait for compiler to finish, 4-25
 Wait for program completion, 4-28
 WHEREIS command, 7-93
 Window Base Address dialog, 6-8
 windows

- CASM05W, 8-4
- ICS, 6-7
- WinIDE, 4-1

 Windows 3.x, 1-1, 1-2, 3-3
 Windows 95, 1-1, 1-2, 1-4, 3-3
 WinIDE, 1-1

- Assembler/Compiler Tab, 4-22
- closing files, 4-13
- configuration parameters, 4-17
- configuring external programs, 4-22
- Edit menu, 4-14
- Edit options, 4-14
 - Close/New Project, 4-18
 - Copy, 4-15
 - Cut, 4-15
 - Delete, 4-16
 - Open Project, 4-17
 - Paste, 4-16
 - Redo, 4-15
 - Save Project, 4-18
 - Save Project As, 4-18
 - Select All, 4-16
 - Setup Environment, 4-18
 - Undo, 4-14
- Edit shortcut menu, 4-5
- Environment Menu, 4-17
- Environment options, 4-16
 - Setup Fonts, 4-28
- Environment Settings Dialog, 1-5

Environment Settings dialog
 EXE1 Tab, 1-5
exiting, 4-14
file management, 4-11
file options, 4-11
 Close File, 4-13
 Exit, 4-14
 New File, 4-11
 Open File, 4-12
 Print, 4-13
 Print Setup, 4-14
 Save File, 4-12
 Save File As, 4-12
files, 3-3
filetypes, 4-4
 listing, 4-4
 source code, 4-4
 text, 4-4
font information, 4-16
General Environment Tab, 4-19
INI file, 1-5, 4-16
main window, 4-2
menu options, 4-1, 4-9, 4-10, 6-27, 6-28
menus, 4-9
printing, 4-11
saving files, 4-12
Search options, 4-29
 Find, 4-29
 Find Next, 4-31
 Go to Line, 4-31
shortcut buttons, 4-7, 6-25
source directory, 4-16
source window, 4-3
starting, 4-4
status bar, 4-3
title bar, 4-3
toolbar, 4-7, 6-25
user interface, 4-1
window components, 4-2
Window Menu, 4-32
Window options, 4-31
 Arrange Icons, 4-34
 Cascade, 4-32
 Minimize All, 4-35
 Split, 4-36
 Tile, 4-33
windows, 4-1
WINIDE.INI file, 1-5, 4-16
word wrap, 4-20, 4-21
Word Wrap OFF, 4-22
Wrap to Column, 4-21
Wrap to Window, 4-21

Z

Z command, 7-95

X

X command, 7-94
X index register value, 6-22
XREG command, 7-94

