

Description

The PAM2401 is a high efficiency, current mode, fixed frequency, step-up DC/DC converter with true output disconnect and inrush current limiting. The device includes one 0.10Ω N-channel MOSFET switch and one 0.15Ω P-channel synchronous rectifier. This product has the ability to simply program the output voltage from 2.5V to 5.0V. The switching frequency is 1.0MHz, programmable current limit set by an external resistor from 1.0A to 3.0A with internal soft-start. When loading became light, the converter will automatically enter into PSM to improve the efficiency.

Quiescent current is only 150μA during Pulse Skip Mode operation, maximizing battery life in portable applications. Other features include : <1μA shutdown, anti-ringing control, Hiccup mode at short protection, over voltage protection and over temperature protection.

The PAM2401 is available in MSOP-8 and U-DFN3030-12 packages

Features

- Up to 95% Efficiency
- True Output Disconnect
- Inrush Current Limiting When Power On
- Output Current up to 1000mA at $V_{IN} = 3V$ and $V_{OUT} = 5.0V$
- Fixed Frequency Operation Up to 1MHz
- 0.9V to 4.75V Input Range
- 2.5V to 5.0V Adjustable Output Voltage
- Guaranteed 1.0V Start-Up
- Programmable Current Limit
- Internal Soft-Start
- Internal Compensation
- Pulse Sipping Mode at Light Load Operation
- Hiccup Mode Short Protection
- Over Voltage Protection
- Over Temperature Protection
- <1μA Shutdown Current
- Power Good Indicator
- MSOP-8 and U-DFN3030-12 packages
- **Totally Lead-Free & Fully RoHS Compliant (Notes 1 & 2)**
- **Halogen and Antimony Free. "Green" Device (Note 3)**

- Notes:
1. No purposely added lead. Fully EU Directive 2002/95/EC (RoHS) & 2011/65/EU (RoHS 2) compliant.
 2. See http://www.diodes.com/quality/lead_free.html for more information about Diodes Incorporated's definitions of Halogen- and Antimony-free, "Green" and Lead-free.
 3. Halogen- and Antimony-free "Green" products are defined as those which contain <900ppm bromine, <900ppm chlorine (<1500ppm total Br + Cl) and <1000ppm antimony compounds.

Pin Assignments

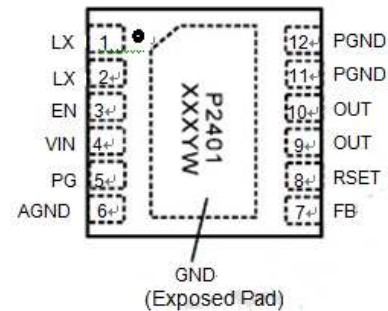
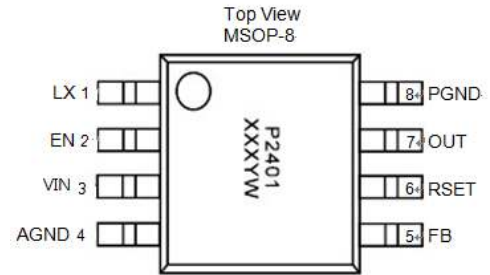

Applications

- Handheld Computers
- Cordless Phones
- GPS Receivers
- Battery Backup Supplies

Typical Applications Circuit

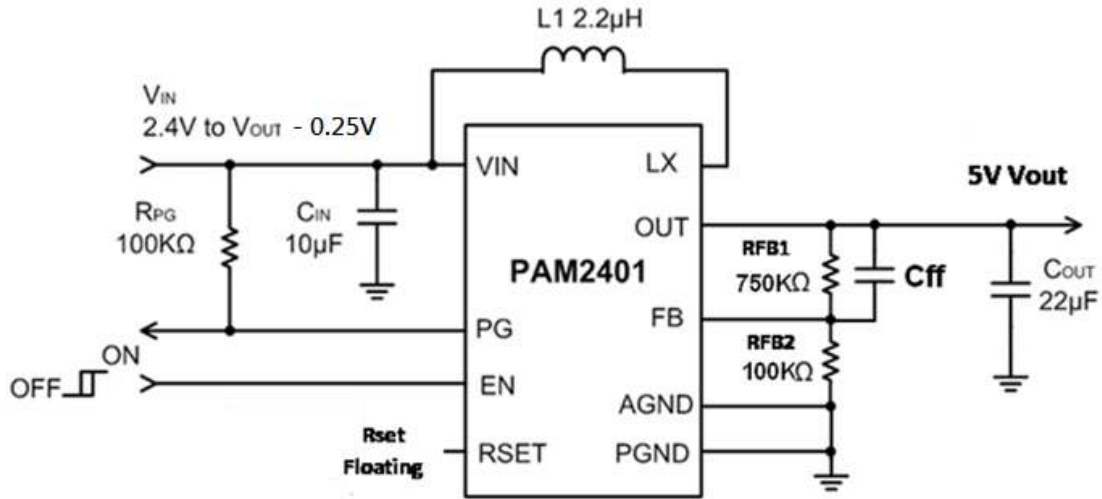

Pin Descriptions

MSOP-8	U-DFN3030-12	Name	Function
1	1,2	LX	Switch Pin
2	3	EN	Enables Control Input.
3	4	VIN	Input Voltage Pin
--	5	PG	Power Good Indicator Pin, Open Drain Output
4	6	AGND	Analog Ground
5	7	FB	Feedback Pin Internally Set to 0.6V.
6	8	RSET	Current Limit Setting
7	9,10	OUT	Output Pin
8	11,12	PGND	Power Ground
	Exposed Pad	EP	Thermal Pad of the Package. Can Be Connected to PGND

Functional Block Diagram

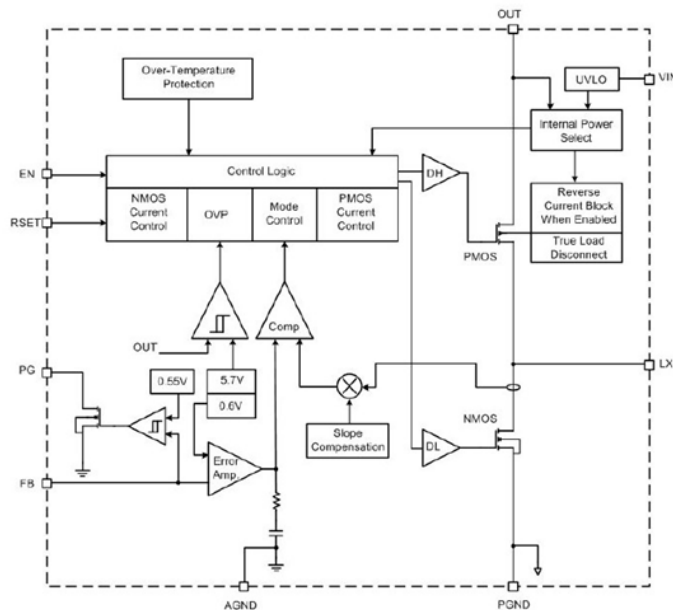

Absolute Maximum Ratings (@T_A = +25°C, unless otherwise specified.)

These are stress ratings only and functional operation is not implied. Exposure to absolute maximum ratings for prolonged time periods may affect device reliability. All voltages are with respect to ground.

Parameter	Rating	Unit
Input Voltage	-0.3 to +6.0	V
SW Voltage	-0.3 to +6.0	V
SHDN, FB Voltage	-0.3 to +6.0	V
V _{OUT}	-0.3 to +6.0	V
Operating Temperature Range	-40 to +85	°C
Storage Temperature Range	-65 to +125	°C
Lead Temperature (Soldering, 10 sec)	300	°C

Recommended Operating Conditions (@T_A = +25°C, unless otherwise specified.)

Parameter	Rating	Unit
Ambient Temperature Range	-40 to +85	°C
Junction Temperature Range	-40 to +125	

Thermal Information

Parameter	Package	Symbol	Max	Unit
Thermal Resistance (Junction to Case)	MSOP-8	Θ _{JC}	75	°C/W
	U-DFN3030-12		8.5	
Thermal Resistance (Junction to Ambient)	MSOP-8	Θ _{JC}	180	
	U-DFN3030-12		60	
Internal Power Dissipation	MSOP-8	P _D	0.55	W
	U-DFN3030-12		1.66	

Electrical Characteristics ($T_A = +25^\circ\text{C}$, $V_{IN} = 3.3\text{V}$, $V_{OUT} = 5\text{V}$, $L = 2.2\mu\text{H}$, unless otherwise noted.)

PARAMETER	SYMBOL	Test Conditions	Min	Typ	Max	Units
Input Voltage Range	V_{IN}	No load, $V_O = 5\text{V}$	0.9		4.75	V
		$I_O = 1\text{A}$, $V_O = 5\text{V}$	2.7		4.75	
Minimum Startup Voltage	$V_{STARTUP}$	$I_O = 0.1\text{A}$, $V_O = 3.3\text{V}$		1		V
Shutdown Supply Current	I_{SD}			0.1	1	μA
Quiescent Current	I_q	No load, switching (measured with external feedback); $V_O = 5\text{V}$		150		μA
Oscillator Frequency	f_{OSC}		0.8	1	1.2	MHz
Maximum Duty Cycle	D_{MAX}			87.5		%
Output-Voltage Adjust Range	V_O		2.5		5	V
FB Regulation Voltage	V_{FB}	No Load	0.588	0.6	0.612	V
Load Regulation	LDR	$I_{OUT} = 1\text{mA}$ to 1000mA		2.5		%
Line Regulation	LNR	$V_O = 2.5\text{V}$ to 4.75V , $I_O = 0.5\text{A}$		0.3		%/V
Drain-Source On-State Resistance	$R_{DS(ON)}$	P MOSFET		150	250	$\text{m}\Omega$
		N MOSFET		100	170	$\text{m}\Omega$
N-Channel Current Limit (Note)	I_{LIMIT}	R_{SET} Floating or $R_{SET} > 200\text{K}\Omega$		3		A
		$R_{SET} = 100\text{K}\Omega$		1.5		A
		$R_{SET} = 66\text{K}\Omega$		1		A
Pre-charge Current	I-Charge	$V_{OUT} + 0.5\text{V} < V_{IN}$		500		mA
Pre-charge Time	T-Charge	$V_{OUT} + 0.5\text{V} < V_{IN}$		400		μs
SW Leakage Current	I_{LSW}		0.1		2	μA
Power Good Threshold	VPG			92		%
EN Threshold High	V_H	$V_{IN} = 0.9\text{V}$	0.8			V
	V_H	$V_{IN} = 3.3\text{V}$	1.5			
EN Threshold Low	V_L	$V_{IN} > 1.2\text{V}$			0.2	V
Over Temperature Threshold	TOTSD			160		$^\circ\text{C}$
Over Temperature Hysteresis	THYS			50		$^\circ\text{C}$

Note: N-Channel current limit is guaranteed by design.

Application Information

Output Voltage Set Equation

The output voltage of the PAM2401, V_{OUT} , is set by an external resistor divider from V_{OUT} to ground as shown in figure 1. The divider tap is connected to the FB pin and the typical value of the voltage at the FB pin is 0.6V. The following equation is used to set the V_{OUT} : $V_{OUT} = 0.6 (1+R1/R2)$ For example, if output voltage of 5V is needed, with a chosen $R2$ value of 100k Ω , the value of $R1$ can be calculated according to the equation, so a 750k Ω resistor should be chosen for $R1$.

Inductor Selection

To select an inductor for use in PAM2401 applications, it is worth noting that the inductor current saturation rating should be larger than the possible peak inductor current to ensure proper operation, and should have low DCR (DC resistance). Using an inductor the saturation current of which is lower than required can cause a dramatic drop in the inductance and can decay the maximum output current levels severely. For most applications, the value of the inductor should be in the range of 1 μ H to 4.7 μ H. Its value is chosen based on the desired ripple current.

Larger value inductors result in lower ripple currents, and smaller value inductors result in higher ripple currents. A 1.5 μ H or 2.2 μ H inductor will be the best choice for most PAM2401 applications. The following equation can also help give a good approximate value for the inductor.

$$L = \frac{V_{IN} \times D}{\Delta I_L \times f}$$

D Duty Cycle = $1 - V_{IN}/V_{OUT}$, F Switching Frequency = 1.0MHz, ΔI_L Ripple Current in the Inductor, i.e., 20% to 40% of the maximum inductor current (I_p).

Output and Input Capacitor Selection

Input Capacitor

At least a 10 μ F input capacitor is recommended to reduce the input ripple and switching noise for normal operating conditions, while a 10-22 μ F capacitor may be required for higher power and dynamic loads. Larger values and lower ESR (Equivalent Series Resistance) may be needed if the application require very low input ripple. It follows that ceramic capacitors are a good choice for applications. Note that the input capacitor should be located as close as possible to the IC.

Output Capacitor

A minimum output capacitor value of 22 μ F is recommended and may be increase to a larger value. The ESR of the output capacitor is important because it determines the peak to peak output voltage ripple by the following equation:

$$\Delta V_{OUT} \gg 2\Delta I_L \times RESR$$

Multilayer ceramic capacitors are an excellent choice as they have extremely low ESR and are available in small footprints.

Typical Performance Characteristics ($T_A = +25^\circ\text{C}$, $V_{IN} = 3.3\text{V}$, $V_{OUT} = 5\text{V}$, unless otherwise noted.)

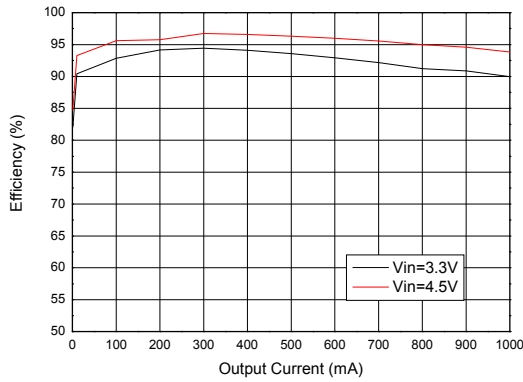

Figure 4 Efficiency vs. Output Current (MSOP-8)

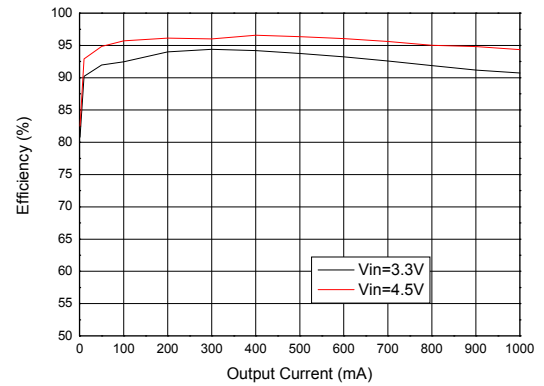

Figure 5 Efficiency vs. Output Current (U-DFN)

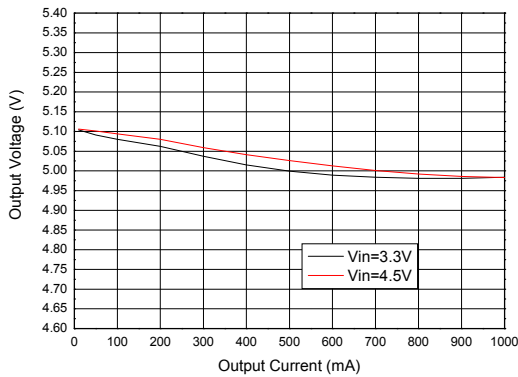

Figure 6 Output Voltage vs. Output Current

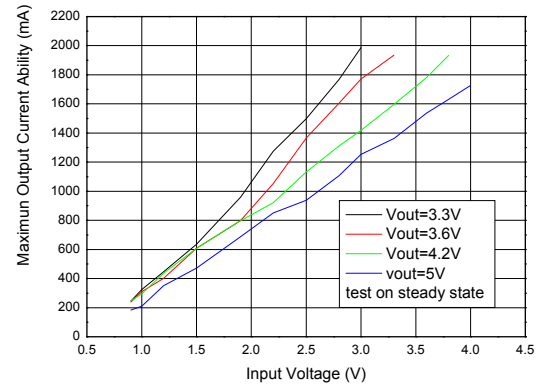

Figure 7 Maximum Output Current vs. Input Voltage

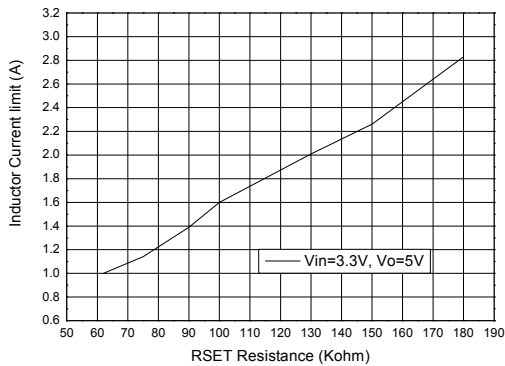

Figure 8 Inductor Current Limit vs. RSET Resistance

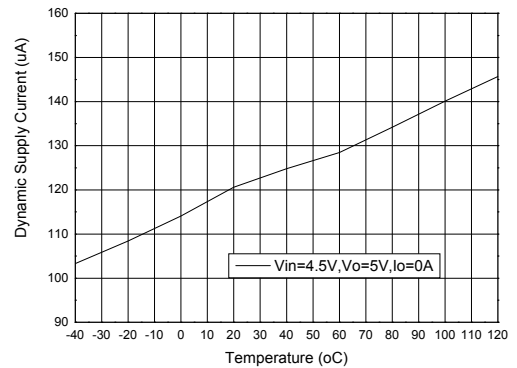

Figure 9 Dynamic Supply Current vs. Temperature

Typical Performance Characteristics (cont.) ($T_A = +25^\circ\text{C}$, $V_{IN} = 3.3\text{V}$, $V_{OUT} = 5\text{V}$, unless otherwise noted.)

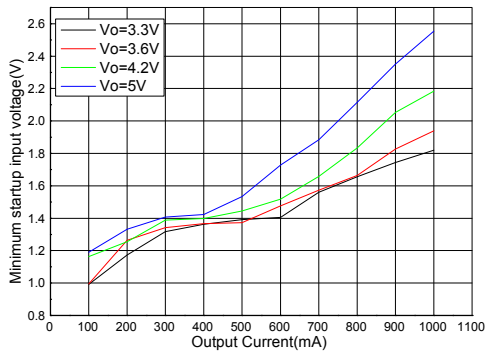

Figure 10 Minimum Startup Input Voltage vs. Output Current

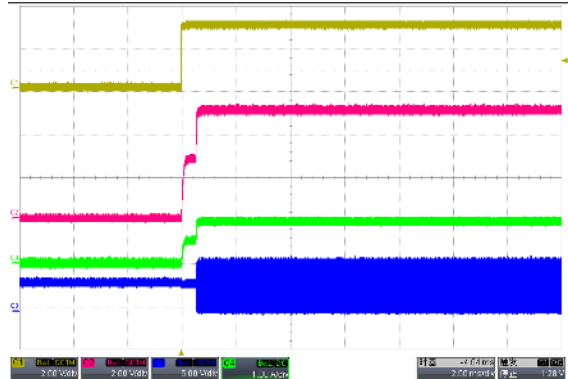

Figure 11 Enable Turn On ($I_O = 1\text{A}$)
(CH1: Enable; CH2: V_{OUT} ; CH3: SW; CH4: I_O)

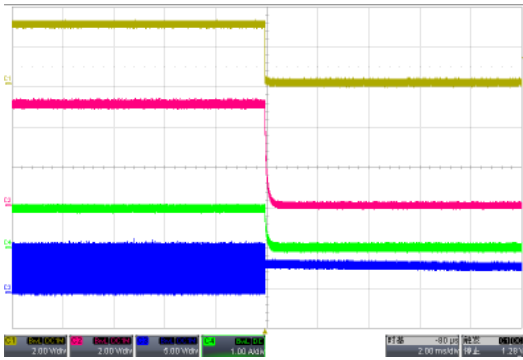

Figure 12 Enable Turn Off ($I_O = 1\text{A}$)
(CH1: Enable; CH2: V_{OUT} ; CH3: SW; CH4: I_O)

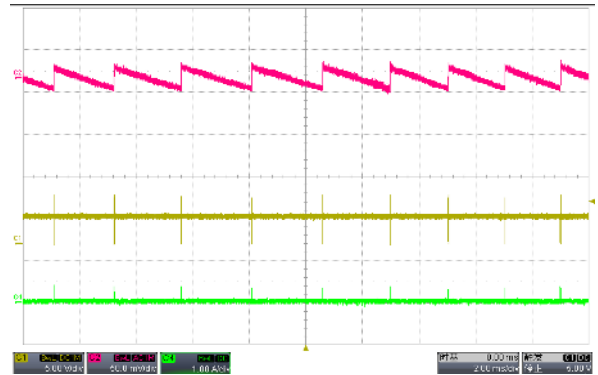

Figure 13 Output Ripple ($I_O = 0\text{A}$)
(CH1: SW; CH2: V_{OUT-AC} ; CH4: IL)

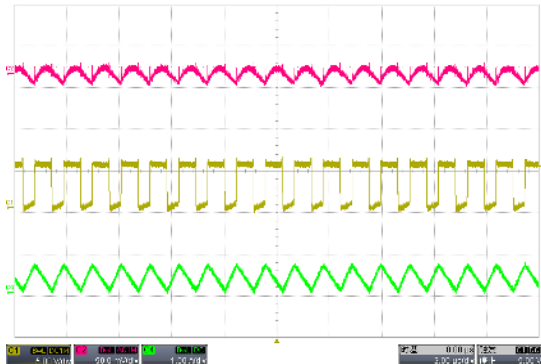

Figure 14 Output Ripple ($I_O = 0.2\text{A}$)
(CH1: SW; CH2: V_{OUT-AC} ; CH4: IL)

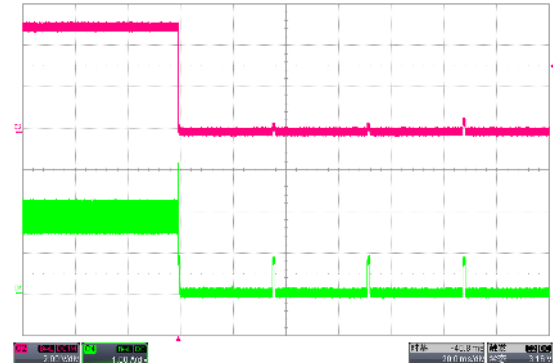

Figure 15 V_{OUT} Short Protection ($I_O = 1\text{A}$)
(CH2: V_{OUT} ; CH3: IL)

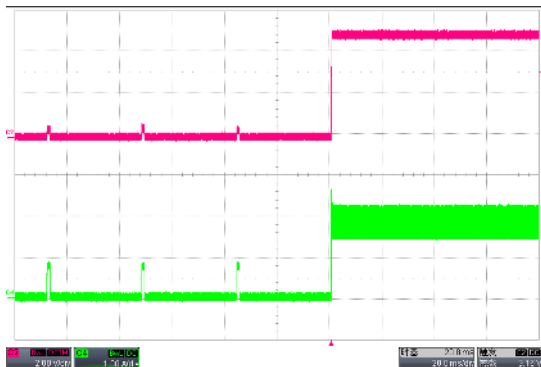
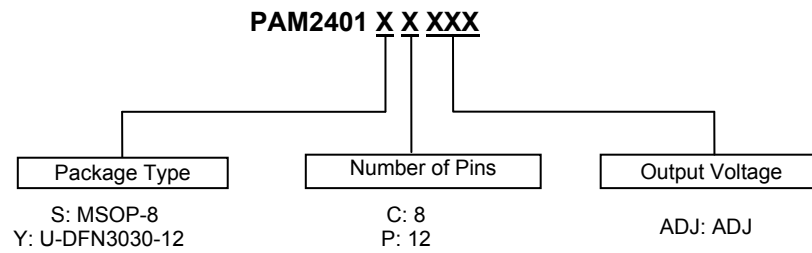

Figure 16 V_{OUT} Short Recovery ($I_O = 1\text{A}$)
(CH2: V_{OUT} ; CH3: IL)

Ordering Information



Part Number	Marking	Package Type	Standard Package
PAM2401SCADJ	P2401 XXXYW	MSOP-8	2,500 units/ Tape & Reel
PAM2401YPADJ	P2401 XXXYW	U-DFN3030-12	3,000 units/ Tape & Reel

Marking Information

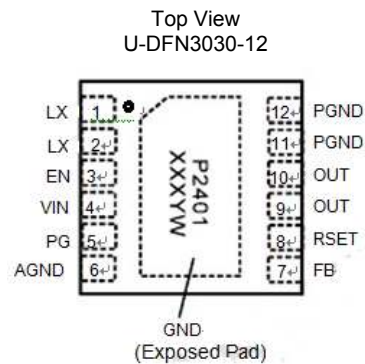
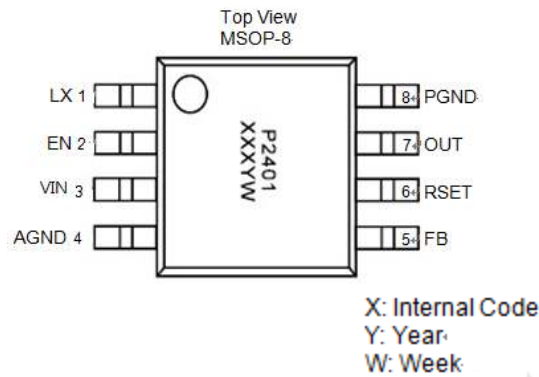

Package Outline Dimensions (All dimensions in mm.)

Please see AP02002 at <http://www.diodes.com/datasheets/ap02002.pdf> for the latest version.

(1) MSOP-8

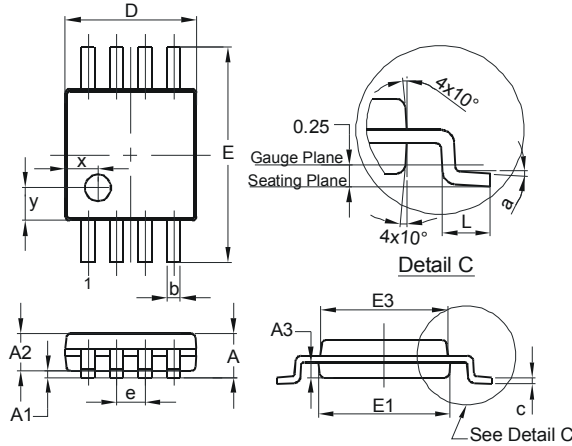

MSOP-8			
Dim	Min	Max	Typ
A	-	1.10	-
A1	0.05	0.15	0.10
A2	0.75	0.95	0.86
A3	0.29	0.49	0.39
b	0.22	0.38	0.30
c	0.08	0.23	0.15
D	2.90	3.10	3.00
E	4.70	5.10	4.90
E1	2.90	3.10	3.00
E3	2.85	3.05	2.95
e	-	-	0.65
L	0.40	0.80	0.60
a	0°	8°	4°
x	-	-	0.750
y	-	-	0.750
All Dimensions in mm			

(2) U-DFN3030-12

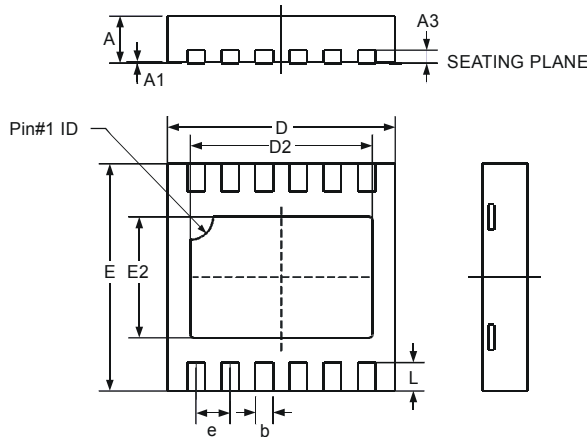

U-DFN3030-12			
Dim	Min	Max	Typ
A	0.57	0.63	0.60
A1	0	0.05	0.02
A3	—	—	0.15
b	0.18	0.28	0.23
D	2.90	3.10	3.00
D2	2.30	2.50	2.40
e	—	—	0.45
E	2.90	3.10	3.00
E2	1.50	1.70	1.60
L	0.25	0.55	0.40
All Dimensions in mm			

Suggested Pad Layout

Please see AP02001 at <http://www.diodes.com/datasheets/ap02001.pdf> for the latest version.

(1) MSOP-8

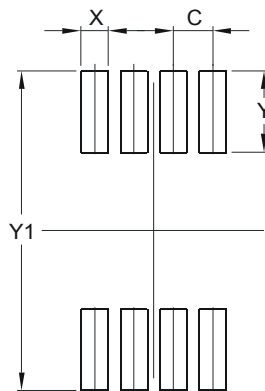

Dimensions	Value (in mm)
C	0.650
X	0.450
Y	1.350
Y1	5.300

Suggested Pad Layout (cont.)

Please see AP02001 at <http://www.diodes.com/datasheets/ap02001.pdf> for the latest version.

(2) U-DFN3030-12

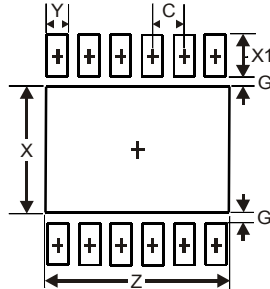

Dimensions	Value (in mm)
Z	2.60
G	0.15
X	1.80
X1	0.60
Y	0.28
C	0.45

IMPORTANT NOTICE

DIODES INCORPORATED MAKES NO WARRANTY OF ANY KIND, EXPRESS OR IMPLIED, WITH REGARDS TO THIS DOCUMENT, INCLUDING, BUT NOT LIMITED TO, THE IMPLIED WARRANTIES OF MERCHANTABILITY AND FITNESS FOR A PARTICULAR PURPOSE (AND THEIR EQUIVALENTS UNDER THE LAWS OF ANY JURISDICTION).

Diodes Incorporated and its subsidiaries reserve the right to make modifications, enhancements, improvements, corrections or other changes without further notice to this document and any product described herein. Diodes Incorporated does not assume any liability arising out of the application or use of this document or any product described herein; neither does Diodes Incorporated convey any license under its patent or trademark rights, nor the rights of others. Any Customer or user of this document or products described herein in such applications shall assume all risks of such use and will agree to hold Diodes Incorporated and all the companies whose products are represented on Diodes Incorporated website, harmless against all damages.

Diodes Incorporated does not warrant or accept any liability whatsoever in respect of any products purchased through unauthorized sales channel. Should Customers purchase or use Diodes Incorporated products for any unintended or unauthorized application, Customers shall indemnify and hold Diodes Incorporated and its representatives harmless against all claims, damages, expenses, and attorney fees arising out of, directly or indirectly, any claim of personal injury or death associated with such unintended or unauthorized application.

Products described herein may be covered by one or more United States, international or foreign patents pending. Product names and markings noted herein may also be covered by one or more United States, international or foreign trademarks.

This document is written in English but may be translated into multiple languages for reference. Only the English version of this document is the final and determinative format released by Diodes Incorporated.

LIFE SUPPORT

Diodes Incorporated products are specifically not authorized for use as critical components in life support devices or systems without the express written approval of the Chief Executive Officer of Diodes Incorporated. As used herein:

A. Life support devices or systems are devices or systems which:

1. are intended to implant into the body, or
2. support or sustain life and whose failure to perform when properly used in accordance with instructions for use provided in the labeling can be reasonably expected to result in significant injury to the user.

B. A critical component is any component in a life support device or system whose failure to perform can be reasonably expected to cause the failure of the life support device or to affect its safety or effectiveness.

Customers represent that they have all necessary expertise in the safety and regulatory ramifications of their life support devices or systems, and acknowledge and agree that they are solely responsible for all legal, regulatory and safety-related requirements concerning their products and any use of Diodes Incorporated products in such safety-critical, life support devices or systems, notwithstanding any devices- or systems-related information or support that may be provided by Diodes Incorporated. Further, Customers must fully indemnify Diodes Incorporated and its representatives against any damages arising out of the use of Diodes Incorporated products in such safety-critical, life support devices or systems.

Copyright © 2014, Diodes Incorporated

www.diodes.com