

SMDB03C THRU SMDB24C TVS ARRAY SERIES



Description

The SMDBXXC series of TVS array have been designed to provide bidirectional protection for sensitive electronics from damage due to voltage transients caused by electrostatic discharge (ESD), electrical fast transients (EFT), lightning and other voltage-induced transient events. The device can be used to protect combinations of four Bidirectional lines.

Schematic & Pin Configuration

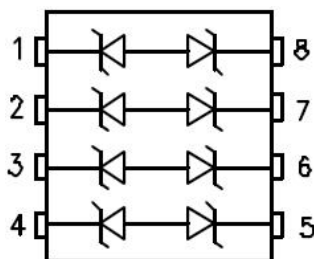

Features

- Protects 3.3, 5, 12, 15, 24 V Components
- Bidirectional
- Provides Electrically Isolated Protection
- 500 W @ 8/20 us
- Protects 4 Lines
- SO-8 Packaging
- This is a Pb – Free Device
- “-A” is an AEC-Q101 qualified device
- All SMC parts are traceable to the wafer lot
- Additional testing can be offered upon request

Mechanical Characteristics

- SO-8 Surface Mount Package
- Approximate Weight: 0.1 grams
- PIN #1 Indicator: DOT on top of package
- Packaging: Tubes or Tape & Reel per EIA Standard 481

Application

- RS-232 data lines
- Microprocessor Based Equipment
- Notebooks, Desktops, & Servers
- LAN/WAN Equipment
- Serial and Parallel Port
- Peripherals

Absolute Maximum Ratings:

Parameter	Symbol	Value	Units
Peak Pulse Power, 8/20 μ s Wave shape	P	500	W
Operating Temperature	T _J	-55 to +125	°C
Storage Temperature	T _{stg}	-55 to +150	°C
Lead Soldering Temperature	T _L	260 (10 Sec.)	°C

Electrical Characteristics@25°C

Part Number	Stand-off Voltage V_{wm} (V) Max	Breakdown Voltage V_{BR} @1mA (V) Min	Clamping Voltage V_c @ 1 A (V) Max	Leakage Current I_R @ V_{wm} (μ A) Max	Capacitance (f = 1MHz) C @ 0V (pF) Max	Temperature Coefficient of V_{BR} a(V_{BR}) mv/°C Max
SMDB03C	3.3	4	7	200	400	-5
SMDB05C	5.0	6	9.8	40	300	1
SMDB12C	12.0	13.3	19	1	94	8
SMDB15C	15.0	16.7	24	1	70	11
SMDB24C	24.0	26.7	43	1	45	28

Ratings and Characteristics Curves

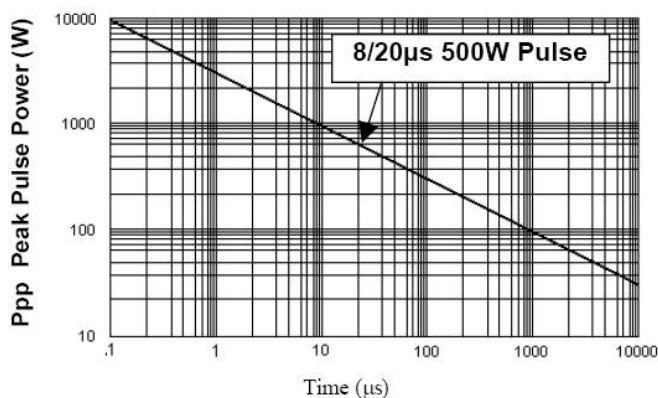

Figure 1. Peak Pulse Power Vs Pulse Time (μ s)

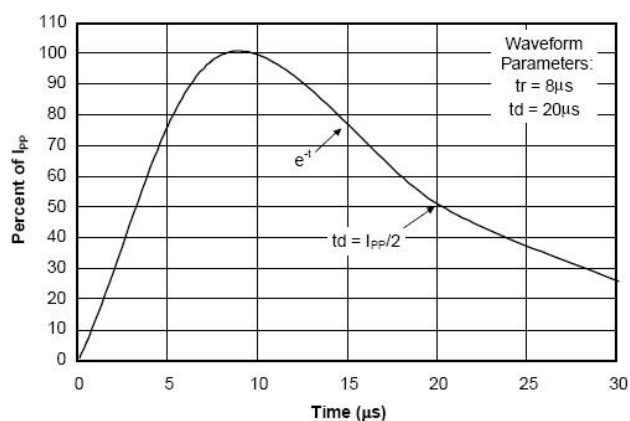

Figure 2. Pulse Wave Form

Ordering Information

Device	Package	Shipping
SMDB03C THRU SMDB24C	SO-8 (Pb-Free)	2500pcs / reel
SMDB03CTR THRU SMDB24CTR	SO-8 (Pb-Free)	2500pcs / reel

For information on tape and reel specifications, including part orientation and tape sizes, please refer to our tape and reel packaging specification.

Marking Diagram

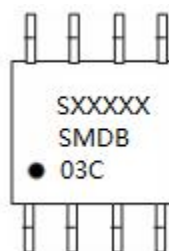

Where XXXXX is YYWWL

SMDB03C = Part Number
S = S
YY = Year
WW = Week
L = Lot Number

Circuit Diagram

The SMDBxxC series of devices are designed to protect up to four data lines. The devices are connected as follows:

- ✓ The SMDBxxC are bidirectional devices and are designed for use on line where the normal operating voltage is above ground. Pins 1, 2, 3, and 4 are connected to the protected lines. Pins 5, 6, 7, and 8 are connected to ground. Since the device is electrically symmetrical, these connections may be reversed. The ground connections should be made directly to the ground plane for best results. The path length is kept as short as possible to reduce the effects of parasitic inductance in the board traces.

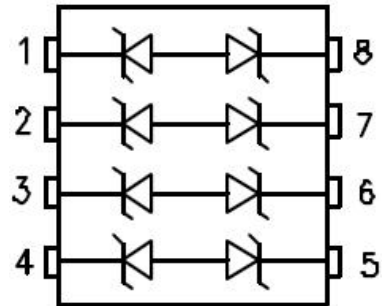

Mechanical Dimensions SO-8

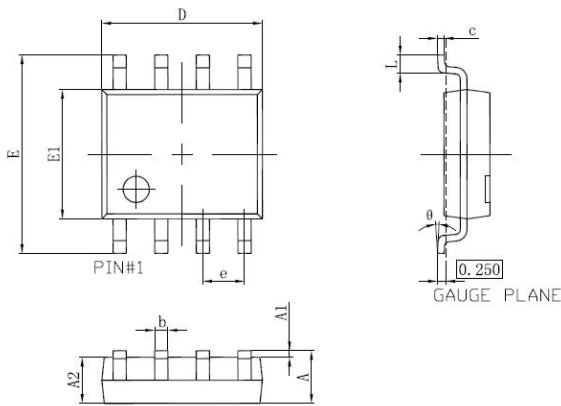

SYMBOL	Millimeters		Inches	
	MIN.	MAX.	MIN.	MAX.
A	1.350	1.800	0.053	0.071
A1	0.100	0.250	0.004	0.010
A2	1.350	1.750	0.053	0.069
b	0.306	0.510	0.012	0.020
c	0.150	0.300	0.006	0.012
D	4.720	5.120	0.186	0.202
e	1.140	1.400	0.045	0.055
E	5.700	6.300	0.224	0.248
E1	3.750	4.150	0.148	0.163
L	0.300	1.270	0.012	0.050
θ	0°	8°	0°	8°

Carrier Tape Specification SO-8

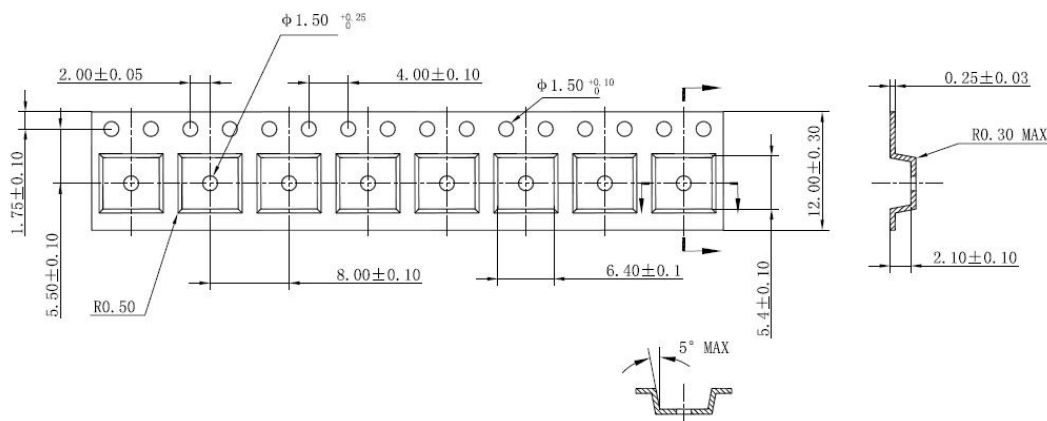



DISCLAIMER:

- 1- The information given herein, including the specifications and dimensions, is subject to change without prior notice to improve product characteristics. Before ordering, purchasers are advised to contact the SMC Diode Solutions sales department for the latest version of the datasheet(s).
- 2- In cases where extremely high reliability is required (such as use in nuclear power control, aerospace and aviation, traffic equipment, medical equipment, and safety equipment), safety should be ensured by using semiconductor devices that feature assured safety or by means of users' fail-safe precautions or other arrangement.
- 3- In no event shall SMC Diode Solutions be liable for any damages that may result from an accident or any other cause during operation of the user's units according to the datasheet(s). SMC Diode Solution assumes no responsibility for any intellectual property claims or any other problems that may result from applications of information, products or circuits described in the datasheets.
- 4- In no event shall SMC Diode Solutions be liable for any failure in a semiconductor device or any secondary damage resulting from use at a value exceeding the absolute maximum rating.
- 5- No license is granted by the datasheet(s) under any patents or other rights of any third party or SMC Diode Solutions.
- 6- The datasheet(s) may not be reproduced or duplicated, in any form, in whole or part, without the expressed written permission of SMC Diode Solutions.
- 7- The products (technologies) described in the datasheet(s) are not to be provided to any party whose purpose in their application will hinder maintenance of international peace and safety nor are they to be applied to that purpose by their direct purchasers or any third party. When exporting these products (technologies), the necessary procedures are to be taken in accordance with related laws and regulations..