

# User Manual

## PCE-5026

LGA1155

Intel® Core™ i7/i5/i3/Pentium®  
PICMG 1.3 System Host Board  
with DDR3 / SATA2.0 / USB2.0 /  
Single GbE LAN

**ADVANTECH**

*Enabling an Intelligent Planet*

## Copyright

The documentation and the software included with this product are copyrighted 2012 by Advantech Co., Ltd. All rights are reserved. Advantech Co., Ltd. reserves the right to make improvements in the products described in this manual at any time without notice. No part of this manual may be reproduced, copied, translated or transmitted in any form or by any means without the prior written permission of Advantech Co., Ltd. Information provided in this manual is intended to be accurate and reliable. However, Advantech Co., Ltd. assumes no responsibility for its use, nor for any infringements of the rights of third parties, which may result from its use.

## Acknowledgements

AMIBIOS is a trademark of American Megatrends Inc.

Intel<sup>®</sup>, Intel<sup>®</sup> Core™ i7/i5/i3, Pentium<sup>®</sup> and Xeon<sup>®</sup> are trademarks of Intel<sup>®</sup> Corporation.

Nuvoton is a trademark of Nuvoton Technology Corp.

All other product names or trademarks are the properties of their respective owners.

## Product Warranty (2 years)

Advantech warrants to you, the original purchaser, that each of its products will be free from defects in materials and workmanship for two years from the date of purchase.

This warranty does not apply to any products which have been repaired or altered by persons other than repair personnel authorized by Advantech, or which have been subject to misuse, abuse, accident or improper installation. Advantech assumes no liability under the terms of this warranty as a consequence of such events.

Because of Advantech's high quality-control standards and rigorous testing, most of our customers never need to use our repair service. If an Advantech product is defective, it will be repaired or replaced at no charge during the warranty period. For out-of-warranty repairs, you will be billed according to the cost of replacement materials, service time and freight. Please consult your dealer for more details.

If you think you have a defective product, follow these steps:

1. Collect all the information about the problem encountered. (For example, CPU speed, Advantech products used, other hardware and software used, etc.) Note anything abnormal and list any onscreen messages you get when the problem occurs.
2. Call your dealer and describe the problem. Please have your manual, product, and any helpful information readily available.
3. If your product is diagnosed as defective, obtain an RMA (return merchandise authorization) number from your dealer. This allows us to process your return more quickly.
4. Carefully pack the defective product, a fully-completed Repair and Replacement Order Card and a photocopy proof of purchase date (such as your sales receipt) in a shippable container. A product returned without proof of the purchase date is not eligible for warranty service.
5. Write the RMA number visibly on the outside of the package and ship it prepaid to your dealer.

Part No. 2006502610

Printed in China

Edition 1

October 2012

# Declaration of Conformity

## FCC Class A

Note: This equipment has been tested and found to comply with the limits for a Class A digital device, pursuant to part 15 of the FCC Rules. These limits are designed to provide reasonable protection against harmful interference when the equipment is operated in a commercial environment. This equipment generates, uses, and can radiate radio frequency energy and, if not installed and used in accordance with the instruction manual, may cause harmful interference to radio communications. Operation of this equipment in a residential area is likely to cause harmful interference in which case the user will be required to correct the interference at his own expense.

**Caution!** *There is a danger of a new battery exploding if it is incorrectly installed. Do not attempt to recharge, force open, or heat the battery. Replace the battery only with the same or equivalent type recommended by the manufacturer. Discard used batteries according to the manufacturer's instructions.*



## A Message to the Customer

### Advantech Customer Services

Each and every Advantech product is built to the most exacting specifications to ensure reliable performance in the harsh and demanding conditions typical of industrial environments. Whether your new Advantech equipment is destined for the laboratory or the factory floor, you can be assured that your product will provide the reliability and ease of operation for which the name Advantech has come to be known.

Your satisfaction is our primary concern. Here is a guide to Advantech's customer services. To ensure you get the full benefit of our services, please follow the instructions below carefully.

### Technical Support

We want you to get the maximum performance from your products. So if you run into technical difficulties, we are here to help. For the most frequently asked questions, you can easily find answers in your product documentation. These answers are normally a lot more detailed than the ones we can give over the phone.

So please consult this manual first. If you still cannot find the answer, gather all the information or questions that apply to your problem, and with the product close at hand, call your dealer. Our dealers are well trained and ready to give you the support you need to get the most from your Advantech products. In fact, most problems reported are minor and are able to be easily solved over the phone.

In addition, free technical support is available from Advantech engineers every business day. We are always ready to give advice on application requirements or specific information on the installation and operation of any of our products.

# Memory Compatibility

## PCE-5026 Compatible Memory

Brand	Capacity	Speed	Type	ECC	Vendor PN	Memory	Advantech PN
Transcend	1GB	1066	DDR3	N	TS128MLK64V1U	SEC K4B1G0846G-BCH9	96D3-1G1066NN-TR
	2GB	1066	DDR3	N	TS256MLK64V1U	SEC K4B1G0846G-BCH9	96D3-2G1066NN-TR
	1GB	1333	DDR3	N	TS128MLK64V3U	ELPIDA EDJ1108BFBG-DJ-F	96D3-1G1333NN-TR
	2GB	1333	DDR3	N	TS256MLK64V3U	SEC K4B1G0846G-BCH9	96D3-2G1333NN-TR4
	4GB	1600	DDR3	N	TS512MLK64V6N	MICRON IUM22 D9PFJ	N/A
	2GB	1600	DDR3	N	TS256MLK64V6N	MICRON IRM72 D9PFJ	N/A
	8GB	1600	DDR3	N	TS1GLK64V6H	Micron IZD27 D9PBC 512x8	N/A
Apacer	1GB	1066	DDR3	N	78.01GC3.420	ELPIDA J1108BDBG-DJ-F (128x8)	96D3-1G1066NN-AP
	2GB	1066	DDR3	N	78.A1GC3.421	ELPIDA J1108BDBG-DJ-F (128x8)	96D3-2G1066NN-AP
	4GB	1066	DDR3	N	78.B1GDJ.AF1	HYNIX H5TQ2G83BFR-H9C	N/A
	1GB	1333	DDR3	N	78.01GC6.AF0	H5TQ1G83DFR-H9C	96D3-1G1333NN-AP1
		1333				H5TQ1G83TFR-H9C	
	2GB	1333	DDR3	N	78.A1GDE.4200C	ELPIDA J2108BCSE-DJ-F	96D3-2G1333NN-AP2
	2GB	1333	DDR3	N	78.A1GDE.AF00C	Hynix H5TQ2G838FR(256x8)	96D3-2G1333NN-AP1
	4GB	1333	DDR3	N	78.B1GDE.AF1	HYNIX H5TQ2G83BFR-H9C	96D3-4G1333NN-AP
	8GB	1333	DDR3	N	78.C1GEP.4210C	ELPIDA J4208BASE-DJ-F 512x8	96D3-8G1333NN-AP
8GB	1600	DDR3	N	78.C1GET.ATF0C	Micron 2FD27 D9PCP (512x8)	96D3-8G1600NN-APL	
Kingston	4GB	1333	DDR3	N	KVR1333D3N9/4G	KINGSTON D2568JENCPCGD9U(512x64)	N/A
DSL	2GB	1600	DDR3	N	D3US56081XH12AA	SEC 113 HCK0 K4B2G0846C 256x8	N/A
	4GB	1600	DDR3	N	D3US56082XH12AA	SEC 113 HCK0 K4B2G0846C 256x8	N/A
ATP	8GB	1600	DDR3	N	XQ16B8N8GS-9-AV	SEC K4B4G0846B (512x8)	N/A

## Specification Comparison

Part Number	PCH	Memory	Backplane	LAN	VGA	DVI-D	COM	SATA 2.0	USB 2.0	Raid	iAMT
PCE-5026VG-00A1E	H61	Non-ECC	PCE-5BXX	1	Yes	Optional	2	4	10	N/A	N/A

## Processor Support

Processor \ PN	PCE-5026VG-00A1E
Core i7-3770	Yes
Core i7-2600	Yes
Core i5-3550S	Yes
Core i5-2400	Yes
Core i3-3220	Yes
Core i3-2120	Yes
Pentium G2120	Yes
Pentium G850	Yes
Celeron G540	Yes

## Backplane Support Matrix Table

Model \ Backplane	PCE-5XXX	PCE-7XXX
PCE-5026VG-00A1E	Yes	-

**Note!** *If PCE-5026 is used on different backplanes which have different PCIe configurations the message below will be displayed the first time the unit is powered on. The user has to turn off AC power and then turn it back on for PCIe re-configuration.*



**Caution!** *PCIe configuration error! Please turn off AC power before re-configuration.*



---

## Initial Inspection

Before you begin installing your motherboard, please make sure that the following materials have been shipped:

- 1 PCE-5026 PICMG 1.3 System Host Board
- 1 PCE-5026 startup manual
- 1 CD with utility
- 2 Serial ATA HDD data cable P/N: 1700003194
- 2 Serial ATA HDD power cable P/N: 1703150102
- 1 COM + printer ports cable kit P/N: 1701260305
- 1 4-port USB cable kit P/N: 1700008461
- Keyboard and mouse Y cable P/N: 1700060202
- 1 jumper package P/N: 9689000068
- 1 warranty card

If any of these items are missing or damaged, contact your distributor or sales representative immediately. We have carefully inspected the PCE-5026 mechanically and electrically before shipment. It should be free of marks and scratches and in perfect working order upon receipt. As you unpack the PCE-5026, check it for signs of shipping damage. (For example, damaged box, scratches, dents, etc.) If it is damaged or it fails to meet the specifications, notify our service department or your local sales representative immediately. Also notify the carrier. Retain the shipping carton and packing material for inspection by the carrier. After inspection, we will make arrangements to repair or replace the unit.

# Contents

<b>Chapter 1</b>	<b>Hardware Configuration</b>	<b>1</b>
1.1	Introduction	2
1.2	Features & Benefits	2
1.3	Specifications	3
1.3.1	System	3
1.3.2	Memory	3
1.3.3	Input/Output	3
1.3.4	Graphics	3
1.3.5	Ethernet LAN	4
1.3.6	Industrial Features	4
1.3.7	Mechanical and Environmental Specifications	4
1.4	Jumpers and Connectors	4
	Table 1.1: Jumper List	4
	Table 1.2: Connectors	5
1.5	Board Layout: Jumper and Connector Locations	6
	Figure 1.1 Jumper and Connector Locations	6
1.6	Block Diagram	7
	Figure 1.2 PCE-5026 Block Diagram	7
1.7	Safety Precautions	7
1.8	Jumper Settings	8
1.8.1	How to Set Jumpers	8
1.8.2	BIOS CMOS (JCMOS1)	8
	Table 1.3: Clear BIOS CMOS/Data (JCMOS1)	8
1.8.3	Watchdog Timer Output (JWDT1)	9
	Table 1.4: Watchdog Timer Output (JWDT1)	9
	Table 1.5: H/W Monitor Alarm (JOBS1)	9
1.9	System Memory	10
1.10	Memory Installation Procedures	10
1.11	Cache Memory	10
1.12	Processor Installation	10
1.13	Processor Cooler Installation	12
<b>Chapter 2</b>	<b>Connecting Peripherals</b>	<b>13</b>
2.1	Introduction	14
2.2	Parallel Port (LPT1)	14
2.3	USB Ports (USB12, USB34, USB5, USB6)	14
2.4	VGA Connectors (VGA1)	15
2.5	Serial Ports (COMD1 & COM2)	15
2.6	PS/2 Keyboard and Mouse Connector (KBMS1/KBMS2)	16
2.7	CPU Fan Connector (CPUFAN1)	16
2.8	Front Panel Connectors (JFP1, JFP2 & JFP3)	17
2.8.1	ATX Soft Power Switch (JFP1)	17
2.8.2	Reset Connector (JFP1)	17
2.8.3	HDD LED Connector (JFP2)	17
2.8.4	External speaker (JFP2)	18
2.8.5	Power LED and Keyboard Lock (JFP3)	18
	Table 2.1: PS/2 or ATX Power Supply LED Status	18
2.9	H/W Monitor/Watchdog Timer/Infrared	18
2.9.1	H/W Monitor Alarm (JOBS1)	19
2.9.2	Watchdog Timer (JWDT1)	19
2.9.3	Infrared Interface (JIR1)	19
2.10	LAN Port (LAN1)	19
	Table 2.2: LAN LED Indicators	19

2.11	High Definition Audio Module Interface (HDAUD1) .....	20
	Figure 2.1 Jumper and connector locations of PCA-AUDIO-HDA1E .....	21
2.12	GPIO Header (GPIO1).....	22
2.13	Case Open Connector (JCASE1).....	22
2.14	Front Panel LAN Indicator Connector (LANLED1).....	23
	Table 2.3: LAN LED Indicators .....	23
2.15	Serial ATA Interface (SATA1~SATA4).....	24
2.16	LPC Extension Interface (LPC1).....	24

## **Chapter 3 AMI BIOS Setup..... 25**

3.1	Introduction .....	26
	Figure 3.1 Setup Program Initial Screen .....	26
3.2	Entering Setup .....	27
3.2.1	Main Setup.....	27
	Figure 3.2 Main Setup Screen.....	27
3.2.2	Advanced BIOS Features Setup.....	28
	Figure 3.3 Advanced BIOS Features Setup Screen.....	28
	Figure 3.4 Advantech BIOS Update V1.3.....	29
	Figure 3.5 PCI Subsystem Settings.....	30
	Figure 3.6 PCI Express Settings .....	31
	Figure 3.7 ACPI Settings .....	32
	Figure 3.8 Trust Computing.....	33
	Figure 3.9 S5 RTC Configuration .....	34
	Figure 3.10 CPU Configuration .....	34
	Figure 3.11 SATA Configuration.....	35
	Figure 3.12 Intel Trusted Execution Technology Configuration...	36
	Figure 3.13 USB Configuration.....	37
	Figure 3.14 Smart Settings.....	38
	Figure 3.15 Super I/O Configuration.....	38
	Figure 3.16 Serial Port 1 Configuration .....	39
	Figure 3.17 Serial Port 2 Configuration .....	39
	Figure 3.18 Parallel Configuration .....	40
	Figure 3.19 PC Health Status .....	41
	Figure 3.20 CPU PPM Configuration.....	42
3.2.3	Chipset.....	43
	Figure 3.21 Chipset .....	43
	Figure 3.22 PCH I/O Configuration.....	43
	Figure 3.23 PCI Express Configuration .....	44
	Figure 3.24 USB Configuration.....	45
	Figure 3.25 PCH Azalia Configuration.....	46
	Figure 3.26 System Agent (SA) Configuration .....	47
	Figure 3.27 Graphics Configuration.....	48
	Figure 3.28 NB PCIe Configuration .....	49
	Figure 3.29 Memory Information .....	50
3.2.4	Boot .....	50
	Figure 3.30 Boot .....	50
3.2.5	Security.....	51
	Figure 3.31 Security .....	51
3.2.6	Save & Exit .....	52
	Figure 3.32 Save & Exit.....	52

## **Chapter 4 Chipset Software Installation Utility 55**

4.1	Before You Begin.....	56
4.2	Introduction .....	56
4.3	Windows® XP / Windows® 7 Driver Setup.....	57



<b>Chapter</b>	<b>5</b>	<b>Integrated Graphic Device Setup .....</b>	<b>59</b>
	5.1	Introduction .....	60
	5.2	Windows XP/Windows 7 Driver Setup .....	60
<b>Chapter</b>	<b>6</b>	<b>LAN Configuration.....</b>	<b>61</b>
	6.1	Introduction .....	62
	6.2	Features .....	62
	6.3	Installation .....	62
	6.4	Win XP /Win 7 Driver Setup (LAN).....	62
<b>Chapter</b>	<b>7</b>	<b>Intel ME .....</b>	<b>63</b>
	7.1	Introduction .....	64
	7.2	Installation .....	64
<b>Appendix A</b>		<b>Programming the Watchdog Timer..</b>	<b>65</b>
	A.1	Introduction .....	66
	A.1.1	Watchdog Timer Overview.....	66
	A.1.2	Programming the Watchdog Timer .....	66
		Table A.1: Watchdog Timer Registers .....	67
	A.1.3	Example Program .....	68
<b>Appendix B</b>		<b>I/O Pin Assignments.....</b>	<b>73</b>
	B.1	Parallel Port Connector (LPT1).....	74
		Table B.1: Parallel port Connector (LPT1).....	74
	B.2	VGA Connector (VGA1).....	74
		Table B.2: VGA Connector (VGA1) .....	74
	B.3	RS-232 Seral Port (COMD1).....	75
		Table B.3: COM Connector (COMD1) .....	75
	B.4	RS-232 Serial Port (COM2) .....	75
		Table B.4: RS-232 Serial Port (COM2).....	75
	B.5	USB 2.0 Header (USB12 & USB34) .....	76
		Table B.5: USB Header (USB12 & USB34).....	76
	B.6	PS/2 Keyboard/Mouse Connector (KBMS1).....	76
		Table B.6: PS/2 Keyboard/Mouse Connector (KBMS1) .....	76
	B.7	External Keyboard Connector (KBMS2) .....	77
		Table B.7: External Keyboard Connector (KBMS2).....	77
	B.8	CPU Fan Power Connector (CPUFAN1) .....	77
		Table B.8: CPU Fan Power Connector (CPUFAN1).....	77
	B.9	Power LED and Keyboard Lock Connector (JFP3 / PWR_LED & KEY LOCK) .....	77
		Table B.9: Power LED and Keyboard Lock Connector (JFP3 / PWR_LED & KEY LOCK).....	77
	B.10	External Speaker Connector (JFP2 / SPEAKER) .....	78
		Table B.10:External Speaker Connector (JFP2 / SPEAKER).....	78
	B.11	Reset Connector (JFP1 / RESET) .....	78
		Table B.11:Reset Connector (JFP1 / RESET).....	78
	B.12	HDD LED (JFP2 / HDDLED).....	78
		Table B.12:HDD LED (JFP2 / HDDLED) .....	78
	B.13	ATX Soft Power Switch (JFP1 / PWR_SW).....	79
		Table B.13:ATX Soft Power Switch (JFP1 / PWR_SW) .....	79
	B.14	Hi-definition Audio Link Connector (HDAUD1).....	79

	Table B.14:Hi-Definition Audio Link Connector (HDAUD1) .....	79
B.15	SM Bus Connector (JFP2 / SNMP).....	79
	Table B.15:SM Bus Connector (JFP2 / SNMP).....	79
B.16	LAN1 LED Connector (LANLED1).....	80
	Table B.16:LAN1 LED Connector (LANLED1) .....	80
B.17	GPIO Header (GPIO1).....	80
	Table B.17:GPIO Header (GPIO1) .....	80
B.18	Fixed I/O Ranges Decoded by Intel PCH .....	81
	Table B.18:Fixed I/O Ranges Decoded by PCH.....	81
B.19	System I/O Ports.....	83
	Table B.19:System I/O Ports .....	83
B.20	Interrupt Assignments .....	83
	Table B.20:Interrupt Assignments .....	83
B.21	1 MB Memory Map.....	84
	Table B.21:1 MB Memory Map .....	84
B.22	PCI Bus Map.....	84
	Table B.22:PCI Bus Map .....	84

## **Appendix C      Programming the GPIO ..... 85**

C.1	Supported GPIO Register .....	86
C.2	GPIO Registers.....	86
C.3	GPIO Example Program-1 .....	86

# Chapter 1

Hardware  
Configuration

## 1.1 Introduction

PCE-5026, is a PICMG 1.3 full size form-factor system host board, designed with an Intel® H61 PCH for industrial applications needing high computing power and strong I/O capability. PCE-5026 features either Intel® 22nm or 32nm manufacturing technology processors: Intel® Core™ i7/i5/i3 and Pentium® LGA1155. It comes with integrated memory and graphic controllers, supporting DDR3 1066/1333/1600\* DRAM up to 16 GB (8GB per DIMM). Within advanced silicon technology, PCE-5026 is suitable for power hungry industrial computing applications.

PCE-5026 has excellent 3D graphics processing capability and provides strong 2D transcoding power with an embedded Intel® HD Graphics processor. With the embedded graphics controller, there is no additional cost for discrete graphics cards. Moreover, it also reduces system power consumption and thermal output.

PCE-5026 also has rich I/O interfaces and supports Advantech PCE-5BXX backplanes to offer various expansions such as PCI, PCI-X and PCIe interfaces. PCE-5026 provides four SATA 2.0, ten USB 2.0 and two RS-232 ports for general industrial applications. With flexible I/O interfaces and powerful graphics capability, PCE-5026 is an excellent, cost effective graphics or I/O oriented hardware platform. Accompanied by outstanding performance and exceptional features, PCE-5026 is the ideal computing solution for most industrial applications.

**Note!** PCE-5026 supports PCE-5Bxx series backplane.



## 1.2 Features & Benefits

Features	Benefits
PCE-5026 supports Intel 3rd and 2nd generation processors	Intel's 3rd and 2nd generation Core i7/i5/i3/Pentium processor with quad/dual-core computing power brings quantum-leap performance improvements.
PCE-5026 supports DDR3 1066/1333/1600* SDRAM up to 16GB (8GB per DIMM). *DDR3 1600 is supported by Intel Generation 3 CPU.	To provide higher memory data transmitting and processing efficiency, bringing higher system performance.
PCE-5026 provides one PCIe x16 to backplane.	PCE-5026 supports up to 19 PCE-5BXX series backplanes.
Fully supports Advantech SUSI APIs and Utilities.	To reduce customer S/W development effort with more reliable S/W quality, also provides value-added utilities such as system monitor and Embedded Security ID.
Internal USB type A connector	PCE-5026 supports 2 USB 2.0 type A connectors for USB key lock or dongles to enhance system security.

## 1.3 Specifications

### 1.3.1 System

- **CPU:** LGA1155-socket Core i7/i5/i3 and Pentium processors
- **L2 Cache:** Please refer to CPU specifications for detailed information.
- **BIOS:** AMI SPI BIOS (64 Mb SPI)
- **System Chipset:** Intel H61
- **SATA hard disk drive interface:** Four SATA 2.0(300MB/s) ports, can be enabled or disabled in BIOS menu.

**Note!** PCE-5026 does NOT support PATA(IDE) interface.



### 1.3.2 Memory

- **RAM:**
  - PCE-5026: Up to 16 GB (8GB per DIMM) in two 240-pin DIMM sockets. Supports dual-channel DDR3 1066/1333/1600\* MHz SDRAM WITHOUT ECC function.

**Note!** Wrong memory configuration may cause no boot or system instability problems.



Only Intel generation 3 CPU can support up to DDR3 1600.

### 1.3.3 Input/Output

- **Backplane Support:**  
**Backplane Support Matrix Table:**

Model	Backplane
PCE-5026VG-00A1E	PCE-5BXX

- **PCI bus:** Four PCI masters to the backplane, 32-bit, 33 MHz PCI 2.2 compliant.
- **Enhanced parallel port:** This EPP/SPP/ECP port can be configured for LPT1, LPT2, LPT3 or disabled. A standard DB-25 female is connector provided.
- **Serial ports:** Two RS-232 serial ports
- **PS/2 keyboard and mouse connector:** One 6-pin mini-DIN connector is located on the mounting bracket for easy connection to a PS/2 keyboard and mouse via the Y-cable included in the package.
- **USB port:** Supports 10 USB 2.0 ports with transfer rate of up to 480 Mbps. (6 ports are on the CPU card and 4 ports are on the backplane)

### 1.3.4 Graphics

- **Controller:** Intel® HD Graphics controller is embedded in Intel processor.
- **Display memory:** Shared memory is subject to operating system (Please install 2 GB or above memory for basic system configuration).
- **CRT:** Up to 2048 x 1536 resolution, 400 MHz RAMDAC.
- **PCI express x16 slot on the backplane:** A discrete graphics card can be installed in the PCI-E x16 slot for stronger 2D/3D graphic capability.

### 1.3.5 Ethernet LAN

- Supports single 10/100/1000 Mbps Ethernet port via the dedicated PCI Express x1 bus which provides 500 MB/s data transmission rate.
- **Controller:** LAN 1: Intel® 82579V

### 1.3.6 Industrial Features

- **Watchdog timer:** To generate a system reset. The watchdog timer is programmable, with each unit equal to one second or one minute (255 levels).

### 1.3.7 Mechanical and Environmental Specifications

- **Operating temperature:** 0 ~ 60° C (32 ~ 140° F, Depending on CPU)
- **Storage temperature:** -40 ~ 85° C (-40 ~ 185° F)
- **Humidity:** 20 ~ 95% non-condensing
- **Power supply voltage:** +12 V, +5 V, +3.3 V, +5 V<sub>SB</sub>
- **Power consumption:** Processor: Intel Core i7-3770; Memory: DDR3 1333 8 GB x 2  
Voltage    +12 V        +5 V        +3.3 V        +5 V<sub>SB</sub>  
Current    5.87 A        0.89 A        1.96 A        0.21 A
- **Board size:** 338.58 mm (L) x 126.39 mm (W) (13.3" x 4.98")
- **Board weight:** 0.490 kg

## 1.4 Jumpers and Connectors

Connectors on the PCE-5026 system host board link it to external devices such as hard disk drives and a keyboard. In addition, the board has a number of jumpers used to configure the system for your application.

The tables below list the function of each of the board jumpers and connectors. Later sections in this chapter give instructions on setting jumpers. Chapter 2 gives instructions for connecting external devices to the motherboard.

**Table 1.1: Jumper List**

Label	Function
JCMOS1	CMOS clear
JWDT1	Watchdog Reset
JOBS1	HW Monitor Alarm

**Table 1.2: Connectors**

<b>Label</b>	<b>Function</b>
LPT1	Parallel port, supports SPP/EPP/ECP mode
LAN1	Intel 82579V for all SKUs
VGA1	D-SUB connector
KBMS1	PS/2 keyboard and mouse connector
KBMS2	External keyboard/mouse connector
COMD1	9-pin D-SUB connector
COM2	Serial port: COM2; RS-232 (9-pin Box Header)
JIR1	Infrared connector
JFP3 (Keyboard Lock and Power LED)	Power LED
	Suspend: Fast flash (ATX/AT)
	System On: ON (ATX/AT)
	System Off: OFF (AT)
JFP2	External speaker / SATA HDD LED connector
JFP1	Power Switch / Reset connector
JCASE1	Case Open
CPUFAN1	CPU FAN connector (4-pin)
LANLED1	LAN1/2 LED extension connector
HDAUD1	HD audio extension module connector
USB12	USB port 0, 1
USB34	USB port 2, 3
USB5	USB port 4
USB6	USB port 5
SATA1	Serial ATA1
SATA2	Serial ATA2
SATA3	Serial ATA3
SATA4	Serial ATA4
CPU1	CPU Socket
DIMMA1	Memory connector channel A
DIMMB1	Memory connector channel B
GPIO1	GPIO pin header (SMD pitch-2.0 mm)
LPC1	COM port module expansion pin-header

## 1.5 Board Layout: Jumper and Connector Locations

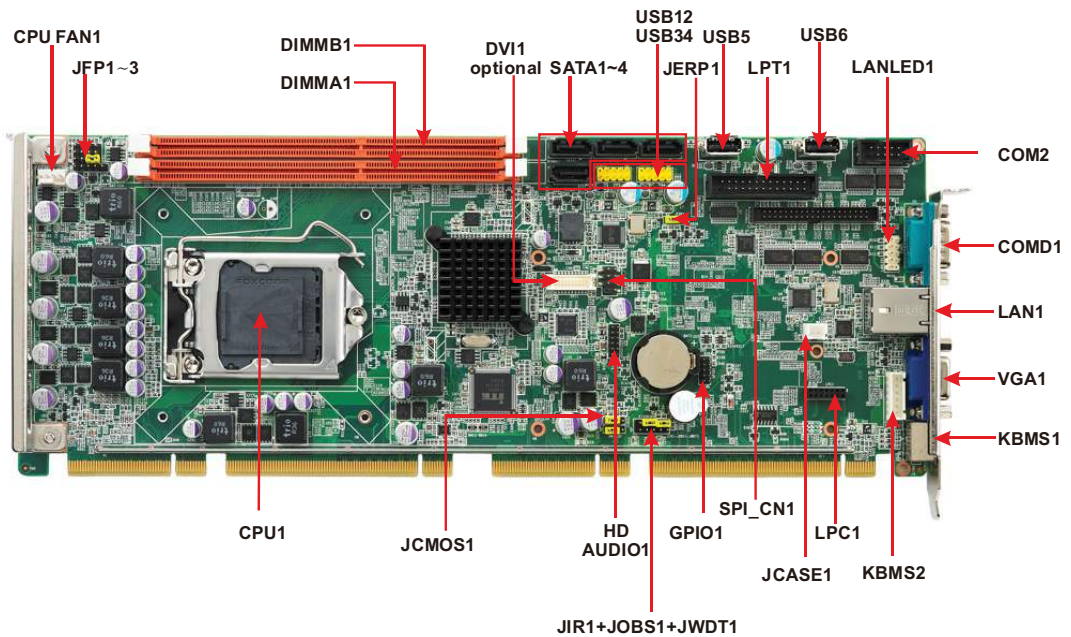


Figure 1.1 Jumper and Connector Locations



## 1.6 Block Diagram

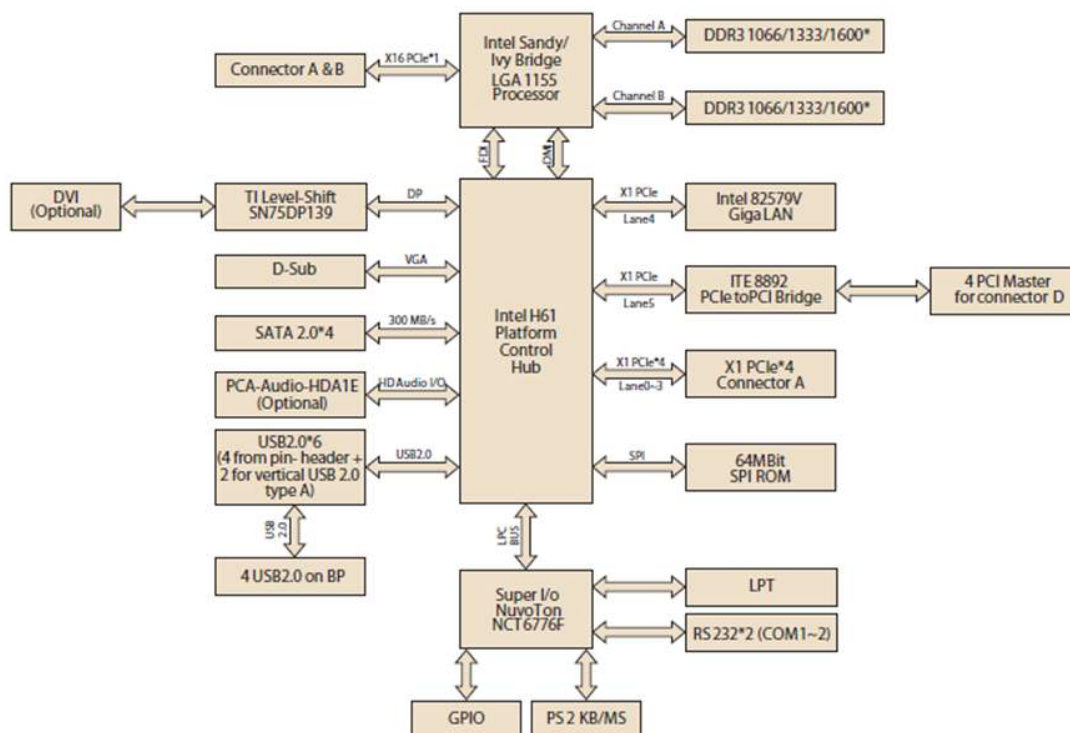


Figure 1.2 PCE-5026 Block Diagram

## 1.7 Safety Precautions

**Warning!** Always completely disconnect the power cord from your chassis whenever you work with the hardware. Do not make connections while the power is on. Sensitive electronic components can be damaged by sudden power surges. Only experienced electronics personnel should open the PC chassis.



**Caution!** Always ground yourself to remove any static charge before touching the motherboard. Modern electronic devices are very sensitive to static electrical discharges. As a safety precaution, use a grounding wrist strap at all times. Place all electronic components on a static-dissipative surface or in a static-shielded bag when they are not in the chassis.



**Caution!** The computer is provided with a battery-powered real-time clock. There is a danger of explosion if battery is incorrectly replaced. Replace only with same or equivalent type recommended by the manufacturer. Discard used batteries according to manufacturer's instructions.



**Caution!** There is a danger of a new battery exploding if it is incorrectly installed. Do not attempt to recharge, force open or heat the battery. Replace the battery only with the same or equivalent type recommended by the manufacturer. Discard used batteries according to the manufacturer's instructions.



## 1.8 Jumper Settings

This section provides instructions on how to configure your motherboard by setting the jumpers. It also includes the motherboard's default settings and your options for each jumper.

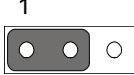

### 1.8.1 How to Set Jumpers

You can configure your motherboard to match the needs of your application by setting the jumpers. A jumper is a metal bridge that closes an electrical circuit. It consists of two metal pins and a small metal clip (often protected by a plastic cover) that slides over the pins to connect them. To “close” (or turn ON) a jumper, you connect the pins with the clip. To “open” (or turn OFF) a jumper, you remove the clip. Sometimes a jumper consists of a set of three pins, labeled 1, 2 and 3. In this case you connect either pins 1 and 2, or 2 and 3. A pair of needle-nose pliers may be useful when setting jumpers.

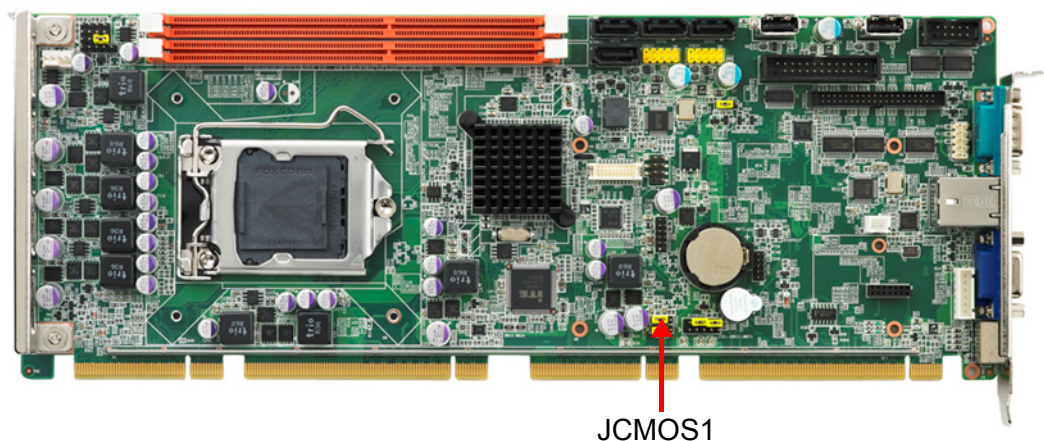
### 1.8.2 BIOS CMOS (JCMOS1)

The PCE-5026 CPU card contains a jumper that can erase BIOS CMOS resetting data about the system BIOS information. Normally this jumper should be set with pins 1-2 closed. If you want to reset data, set JCMOS1 to 2-3 closed for just a few seconds, and then move the jumper back to 1-2 closed. This procedure will reset the CMOS to its last status or default setting.

**Table 1.3: Clear BIOS CMOS/Data (JCMOS1)**

Function	Jumper Setting
*Keep BIOS CMOS data	 1-2 closed
Clear BIOS CMOS data	 2-3 closed

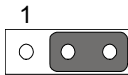
\* default setting

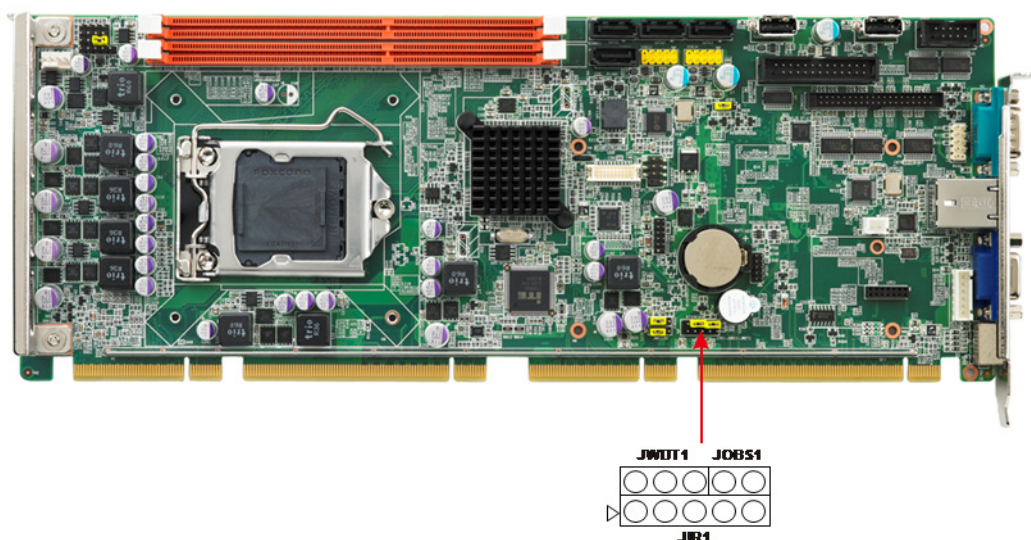


### 1.8.3 Watchdog Timer Output (JWDT1)



The PCE-5026 contains a watchdog timer that will reset the CPU in the event the CPU stops processing. This feature means the PCE-5026 will recover from a software failure or an EMI problem. The JWDT1 jumper settings control the outcome of what the computer will do in the event the watchdog timer is triggered.

**Table 1.4: Watchdog Timer Output (JWDT1)**

Function	Jumper Setting
* Reset	 1                      2-3 closed
*default setting	



**Table 1.5: H/W Monitor Alarm (JOBS1)**

Function	Jumper Setting
Enabled	 1    2                      1-2 closed
Disabled	 1    2                      1-2 opened

(JOBS1) is a 2-pin connector for enabling/disabling alarm while the on-board security event is active.

## 1.9 System Memory

PCE-5026 has two 240-pin memory sockets for Non-ECC DDR3 1066/1333/1600\* memory modules with maximum capacity of 16 GB. (Maximum 8 GB for each DIMM)

**Note!** PCE-5026 does NOT support registered DIMMs (RDIMMs).



## 1.10 Memory Installation Procedures

To install DIMMs, first make sure the two handles of the DIMM socket are in the “open” position; e.g., the handles lean outward. Slowly slide the DIMM module along the plastic guides on both ends of the socket. Then press the DIMM module right down into the socket, until you hear a click. This is when the two handles have automatically locked the memory module into the correct position of the DIMM socket. To remove the memory module, just push both handles outward, and the memory module will be ejected by the mechanism in the socket.

## 1.11 Cache Memory

Intel CPU supports L3 cache. Please refer to the Intel CPU data sheet for detailed information.

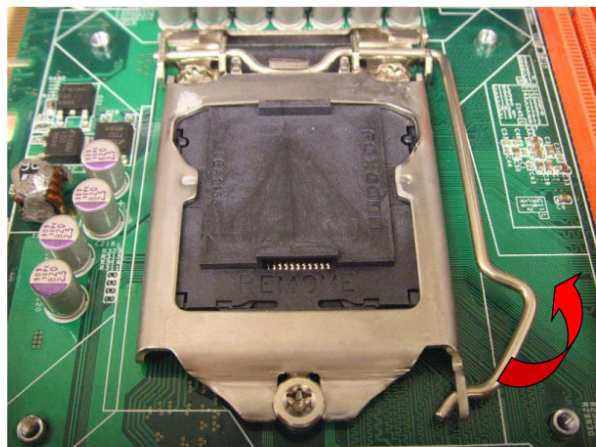
## 1.12 Processor Installation

**Warning!** Without a fan or heat sink, the processor will overheat and cause damage to both the processor and the system host board computer. To install a processor, first turn off your system.

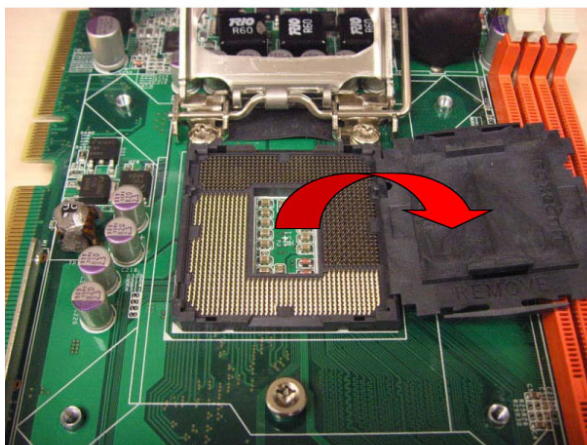


The PCE-5026 is designed for Intel® LGA 1155 socket processors.

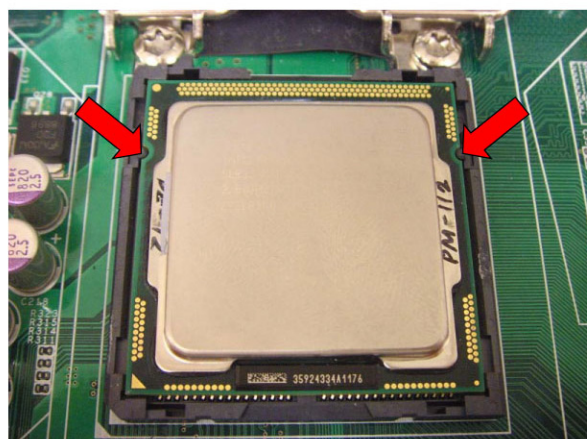
1. Pull the bar beside the processor socket outward and lift it.



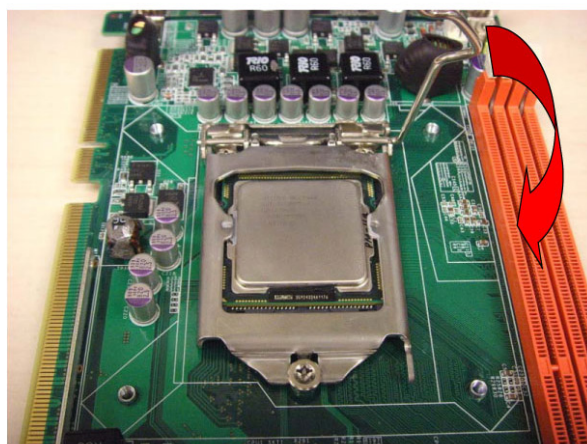
2. Remove the socket protection cap.



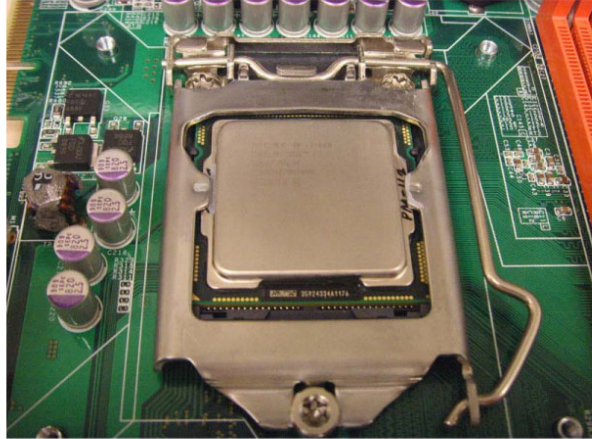
3. Align the cuts on the processor with the edges of the socket.



4. Replace the socket cap; lower the retainer bar and clip it shut.



5. Finished processor installation.



## 1.13 Processor Cooler Installation

Purchasing PCE-5026's proprietary CPU cooler (P/N: 1960047831N001) from Advantech is a must. Other brand CPU coolers are NOT compatible with PCE-5026.

Advantech offers a specially designed CPU cooler for PCE-5026 for better heat dissipation efficiency and enhancing rigidity of the CPU card: part number 1960047831N001. Buy it only for the PCE-5026 CPU card since it is NOT compatible with other brand CPU coolers (it is also not compatible with Intel boxed CPU cooler).

Please install P/N 1960047831N001 CPU cooler following these instructions:

Attach the CPU cooler on CPU card by fastening four screws of the CPU cooler into the steel back-plate on the PCB.



Note the direction of CPU cooler; it must follow the diagram shown above. Installing a CPU cooler in the wrong direction may cause poor heat dissipation that could damage the CPU card.

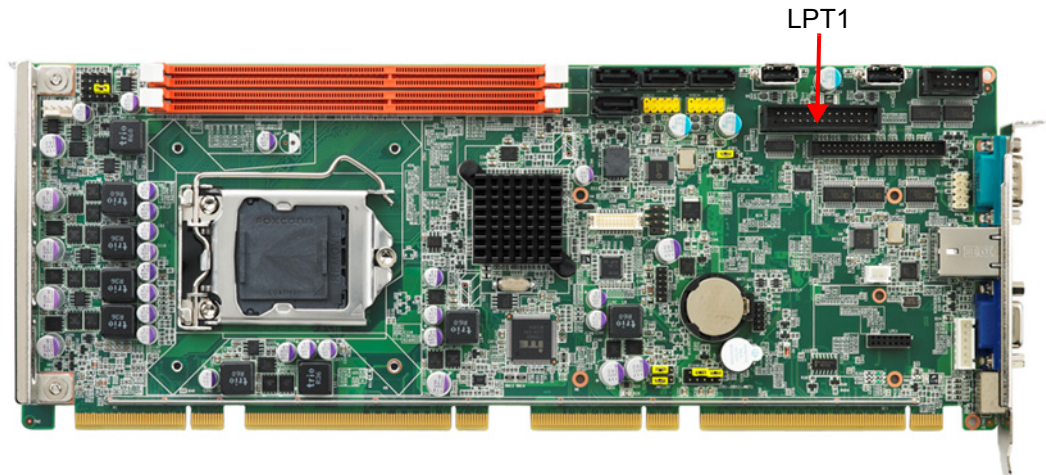
# Chapter 2

Connecting  
Peripherals

## 2.1 Introduction

You can access most of the connectors from the top of the board. If you have a number of cards installed, you may need to partially remove the card to make all the connections.

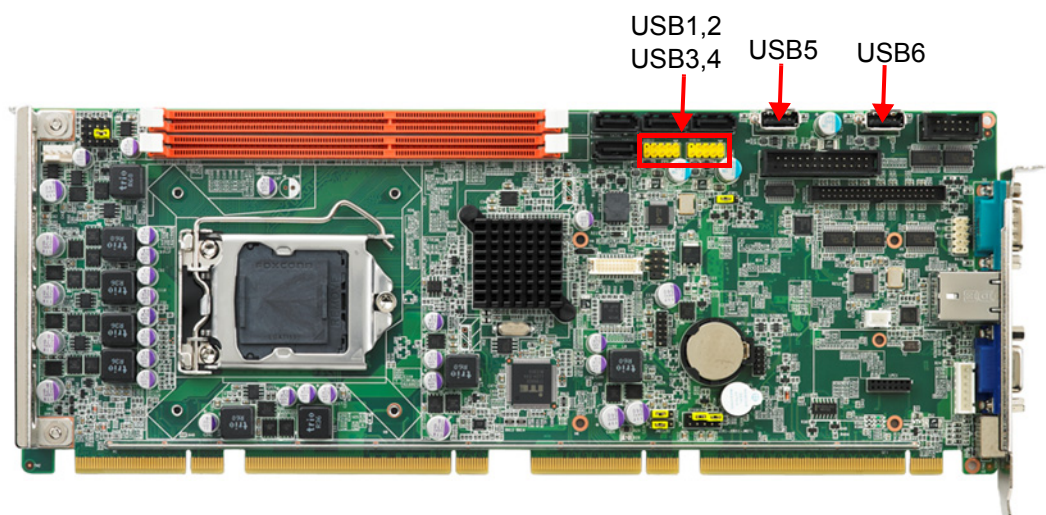
## 2.2 Parallel Port (LPT1)



The parallel port is normally used to connect the motherboard to a printer. The PCE-5026 includes an onboard parallel port, accessed through a 26-pin flat-cable connector, LPT1.

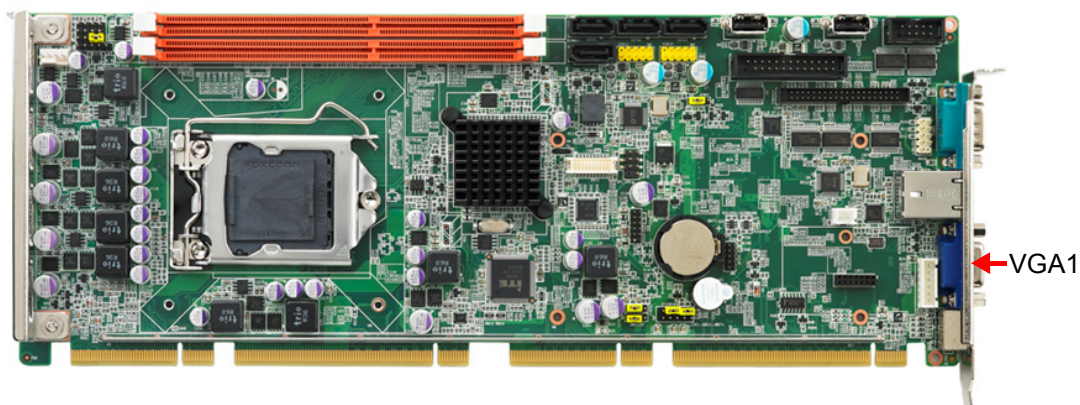
## 2.3 USB Ports (USB12, USB34, USB5, USB6)

The PCE-5026 provides up to 6 USB (Universal Serial Bus) on-board ports with complete Plug & Play and hot swap support for up to 127 external devices. These USB ports comply with USB Specification 2.0, supporting transfer rates up to 480 Mbps (USB2.0). The USB interface can be disabled in the system BIOS setup.



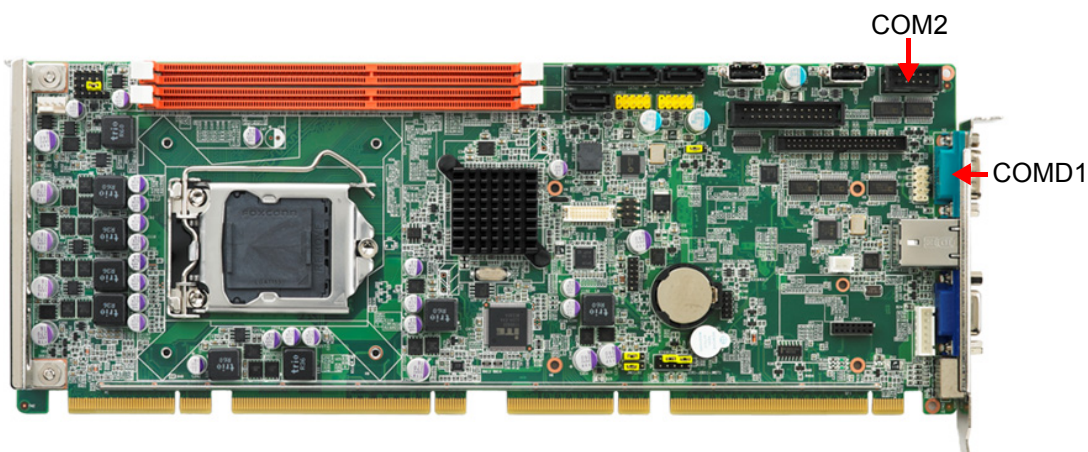


## 2.4 VGA Connectors (VGA1)



This CPU card has VGA outputs that can drive conventional CRT displays. VGA1 is a standard 15-pin D-SUB connector commonly used for VGA.

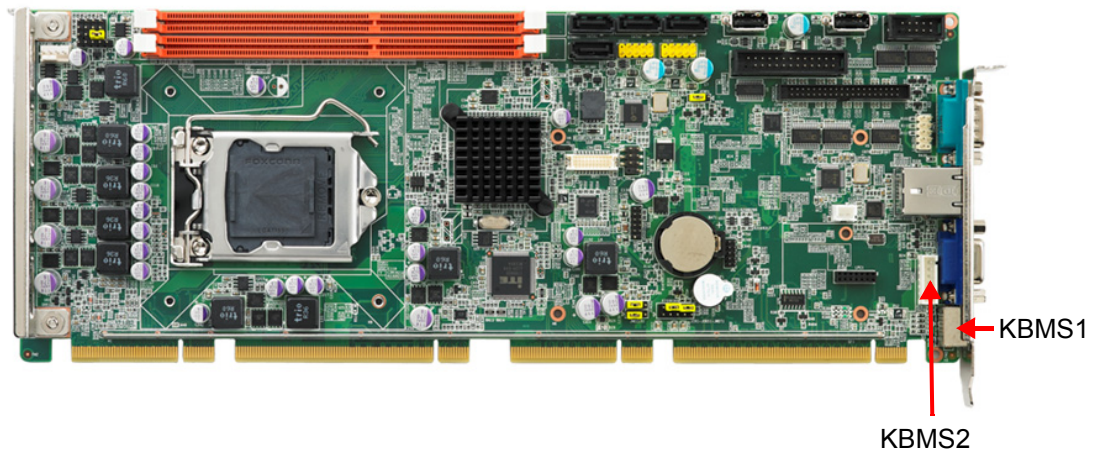
## 2.5 Serial Ports (COMD1 & COM2)



The PCE-5026 offers two serial ports. These ports can connect to serial devices, such as a communication network device.

The IRQ and address ranges for both ports are fixed. However, if you want to disable the port or change these parameters later, you can do this in the system BIOS setup.

## 2.6 PS/2 Keyboard and Mouse Connector (KBMS1/KBMS2)

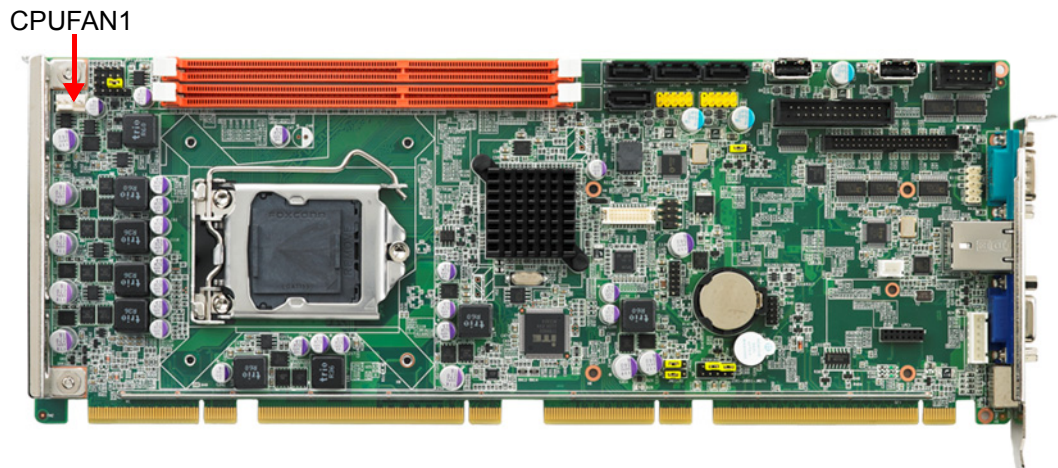


Two on-board 6-pin mini-DIN connectors (KBMS1) provide connection to PS/2 keyboard and mouse by the Y-cable (1700060202) in the package.

The on-board KBMS2 pin header provides connection to the front panel PS/2 keyboard and mouse connector of the chassis.

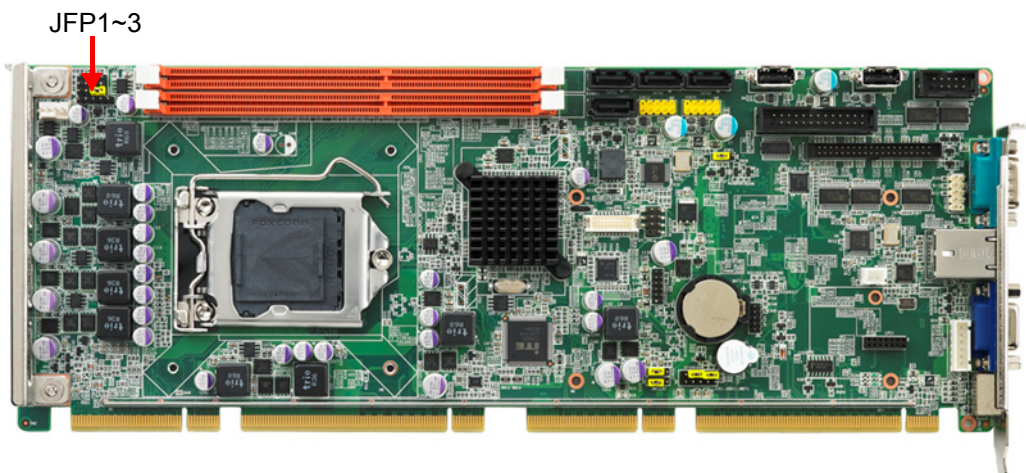
## 2.7 CPU Fan Connector (CPUFAN1)

This connector supports cooling fans of 500 mA (6 W) or less, and it also supports smart fan control when using 4-pin or 3-pin cooler.



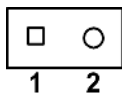
## 2.8 Front Panel Connectors (JFP1, JFP2 & JFP3)

There are several external switches to monitor and control the PCE-5026.



### 2.8.1 ATX Soft Power Switch (JFP1)

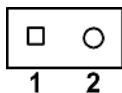
If your computer case is equipped with an ATX power supply, you should connect the power on/off button on your computer case to JFP1. This connection enables you to turn your computer on and off.



JFP1	PWR_SW	Reset
JFP2	HDD LED	SNMP
	Speaker	
JFP3	PWR_LED & Key Lock	

### 2.8.2 Reset Connector (JFP1)

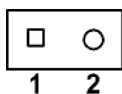
Many computer cases offer the convenience of a reset button. Connect the wire from the reset button.



JFP1	PWR_SW	Reset
JFP2	HDD LED	SNMP
	Speaker	
JFP3	PWR_LED & Key Lock	

### 2.8.3 HDD LED Connector (JFP2)

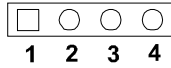
You can connect an LED to connector JFP2 to indicate when the HDD is active.



JFP1	PWR_SW	Reset
JFP2	HDD LED	SNMP
	Speaker	
JFP3	PWR_LED & Key Lock	

## 2.8.4 External speaker (JFP2)

JFP2 is a 4-pin connector for an external speaker. The PCE-5026 provides an onboard buzzer as an alternative to an external speaker. To enable the buzzer, set pins 3 and 4 as closed.



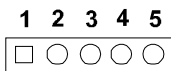
JFP1	PWR_SW	Reset
JFP2	HDD LED	SNMP
	Speaker	
JFP3	PWR_LED & Key Lock	

## 2.8.5 Power LED and Keyboard Lock (JFP3)

JFP3 is a 5-pin connector for the power LED. Refer to Appendix B for detailed information on the pin assignments. If a PS/2 or ATX power supply is used, the system's power LED status will be indicated as shown below:

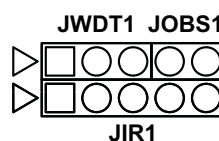
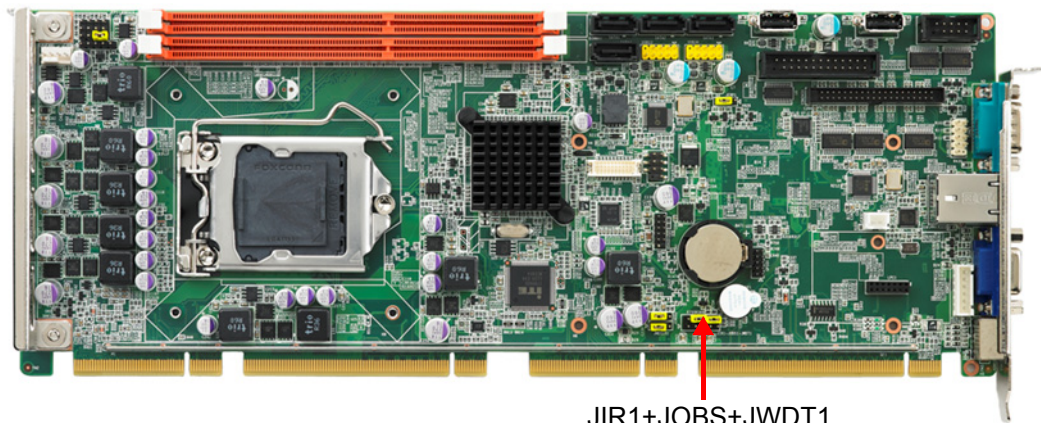
**Table 2.1: PS/2 or ATX Power Supply LED Status**

Power mode	LED (PS/2 power)	LED (ATX power)
System On	On	On
System Suspend	Flashes	Flashes
System Off	Off	Off



JFP1	PWR_SW	Reset
JFP2	HDD LED	SNMP
	Speaker	
JFP3	PWR_LED & Key Lock	

## 2.9 H/W Monitor/Watchdog Timer/Infrared



### 2.9.1 H/W Monitor Alarm (JOBS1)

This 2-pin header is for enabling/disabling H/W monitor alarm function.

Closed: Enables OBS Alarm

Open: Disables OBS Alarm

### 2.9.2 Watchdog Timer (JWDT1)

This is for setting action trigger by watchdog timer.

1-2 Pin Close: No Action

2-3 Pin Close: System Reset

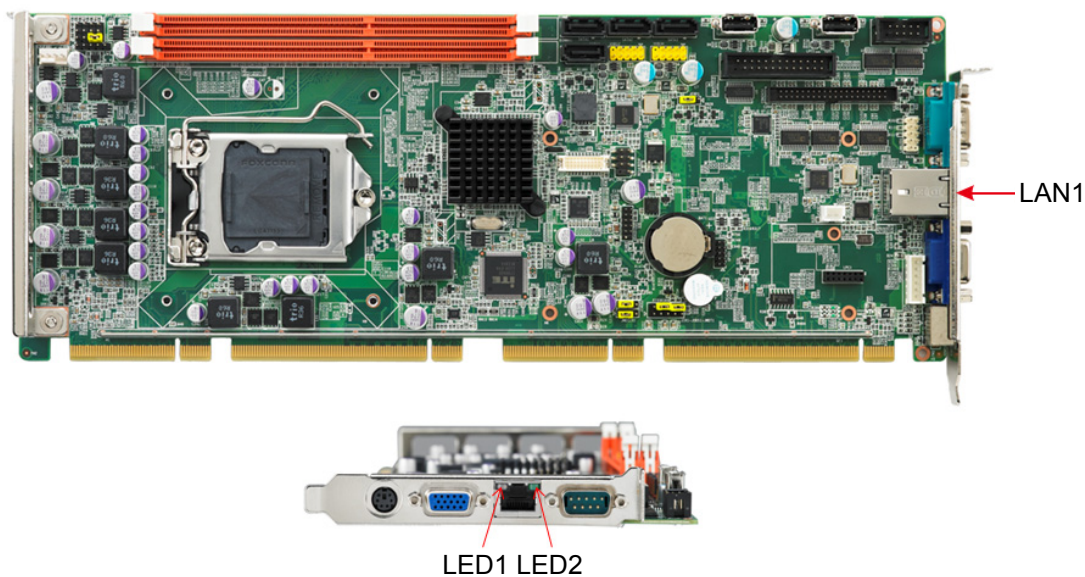
### 2.9.3 Infrared Interface (JIR1)

This is a 5-pin header for an infrared device.

**Note!** Please refer to Figure 3.17 to change COM2 device mode in BIOS menu before using IR device.



## 2.10 LAN Port (LAN1)



The PCE-5026 is equipped with one or two high-performance 1000 Mbps Ethernet LANs. They are supported by all major network operating systems. The RJ-45 jacks on the rear plate provide convenient connectivity.

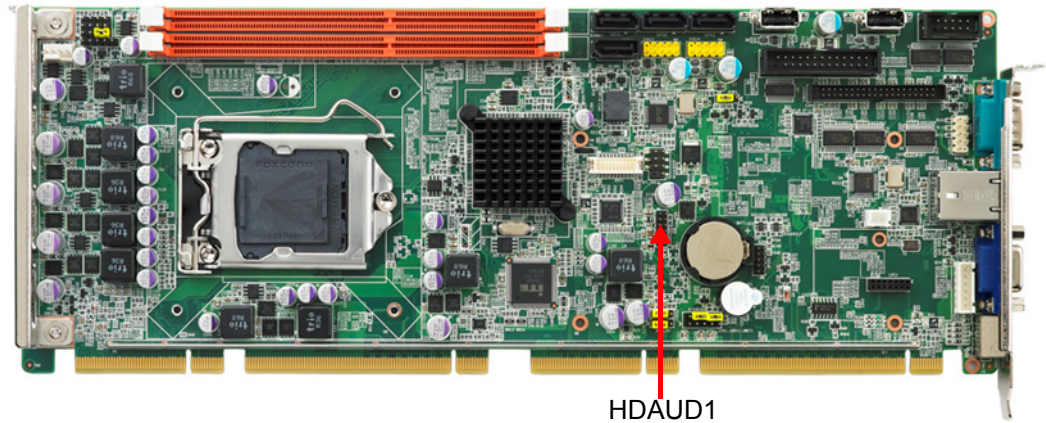
**Table 2.2: LAN LED Indicators**

LAN Mode	LED1	LED2
1000Mbps Link On	Green On	On
1000Mbps Active	Green on	Flash
1000Mbps Link Off	Off	Off
100Mbps Link On	Orange On	On
100Mbps Active	Orange On	Flash

**Table 2.2: LAN LED Indicators**

100Mbps Link Off	Off	Off
10Mbps Link On	Off	On
10Mbps Active	Off	Flash
10Mbps Link Off	Off	Off

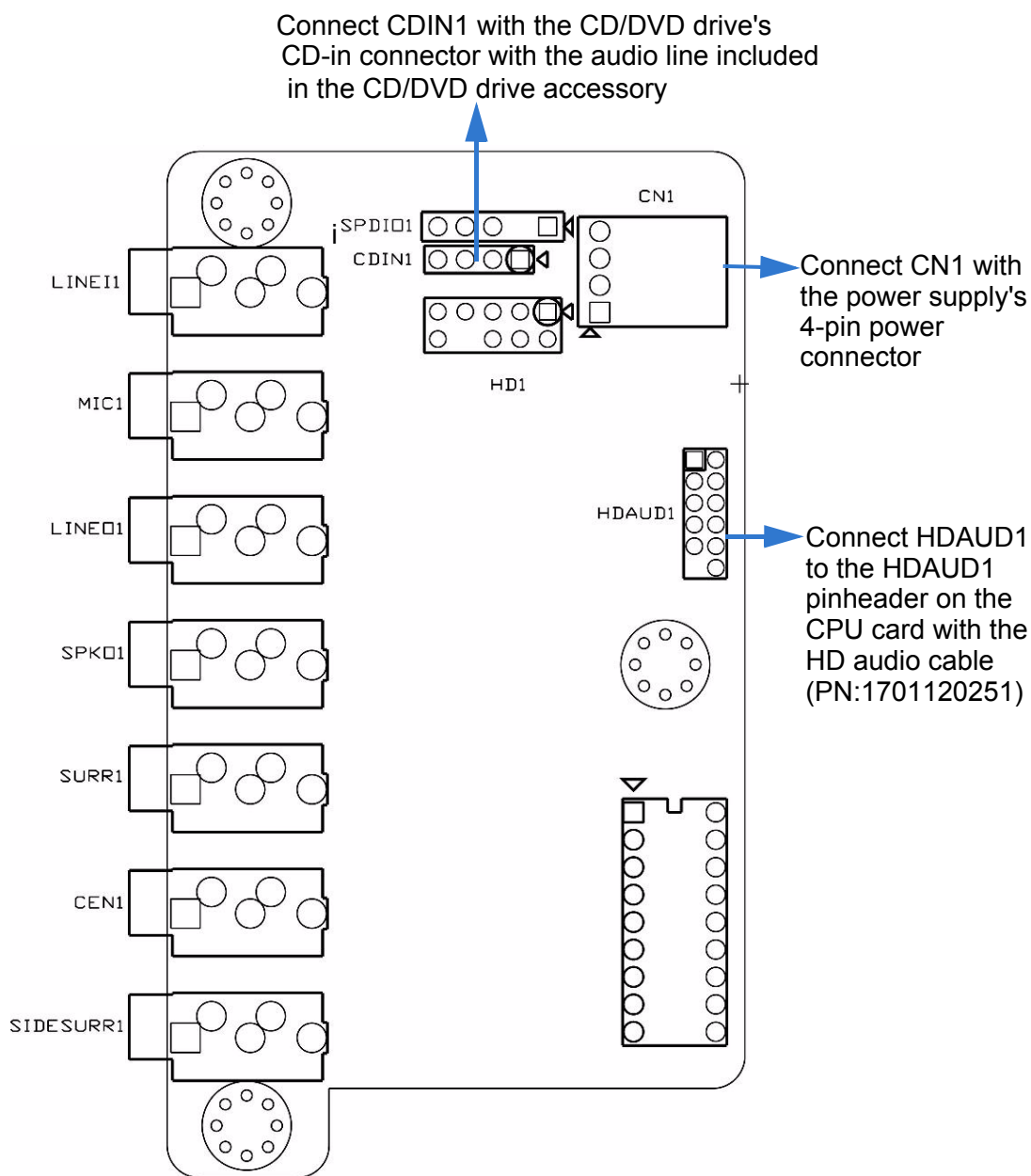
## 2.11 High Definition Audio Module Interface (HDAUD1)



This HDAUD1 pin header is the connection interface to Advantech's 7.1 channel high definition audio module.

**Note!** Advantech 7.1 channel high-definition audio module: PCA-AUDIO-HDA1E.



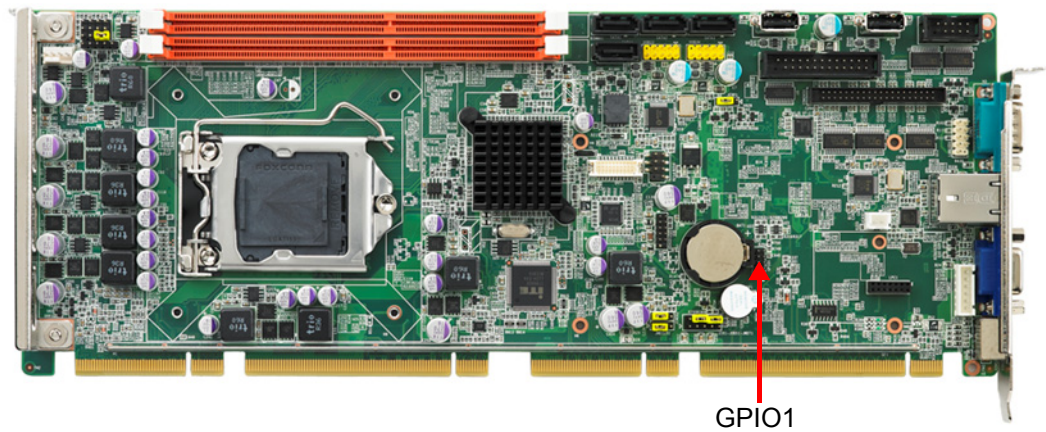


**Figure 2.1** Jumper and connector locations of PCA-AUDIO-HDA1E

**Note!** Please remove the yellow jumper cap on the CPU card's HDAUD1 pinheader before connecting the HD audio cable to it.

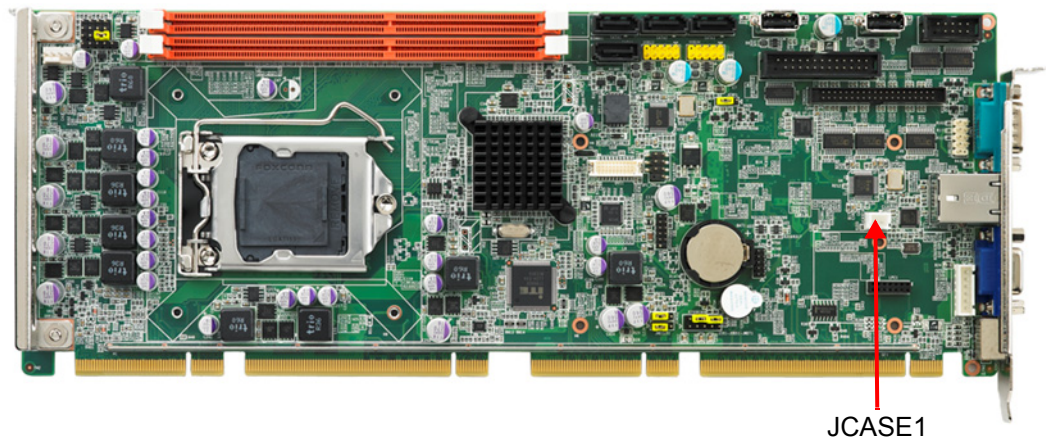


## 2.12 GPIO Header (GPIO1)



Provides 10-Pin pin header for 8-bit Digital I/O usage. Refer to Appendix B for detailed information on the pin assignments and programming guide in Appendix C.

## 2.13 Case Open Connector (JCASE1)



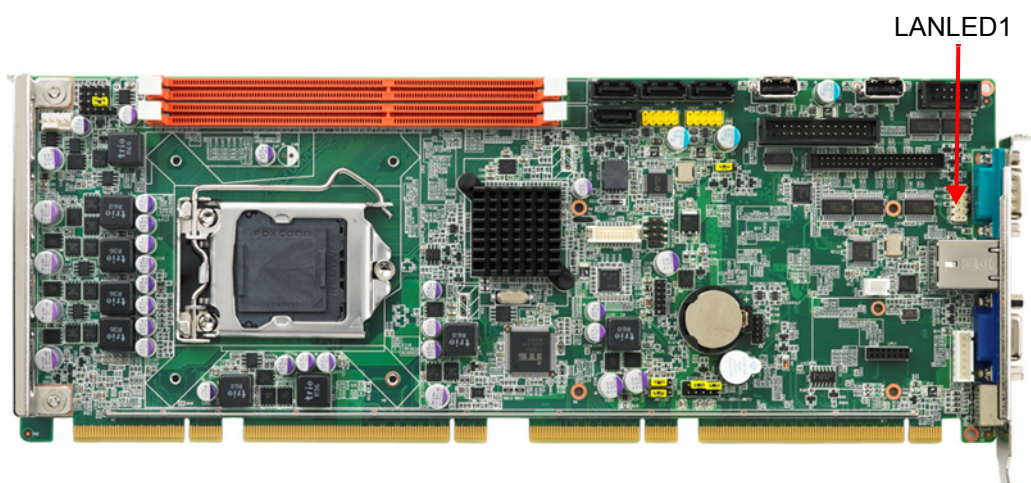
The 2-pin case open connector is for chassis with a case open sensor. When the case is open, the buzzer on motherboard will beep.



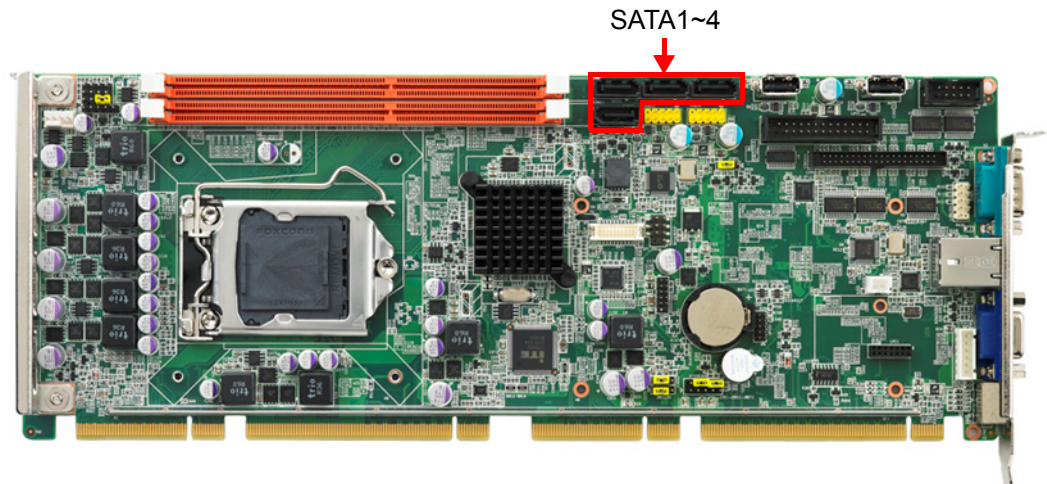
## 2.14 Front Panel LAN Indicator Connector (LANLED1)

**Table 2.3: LAN LED Indicators**


LAN Mode	LED1	LED2
1000Mbps Link On	Green On	On
1000Mbps Active	Green on	Flash
1000Mbps Link Off	Off	Off
100Mbps Link On	Orange On	On
100Mbps Active	Orange On	Flash
100Mbps Link Off	Off	Off
10Mbps Link On	Off	On
10Mbps Active	Off	Flash
10Mbps Link Off	Off	Off



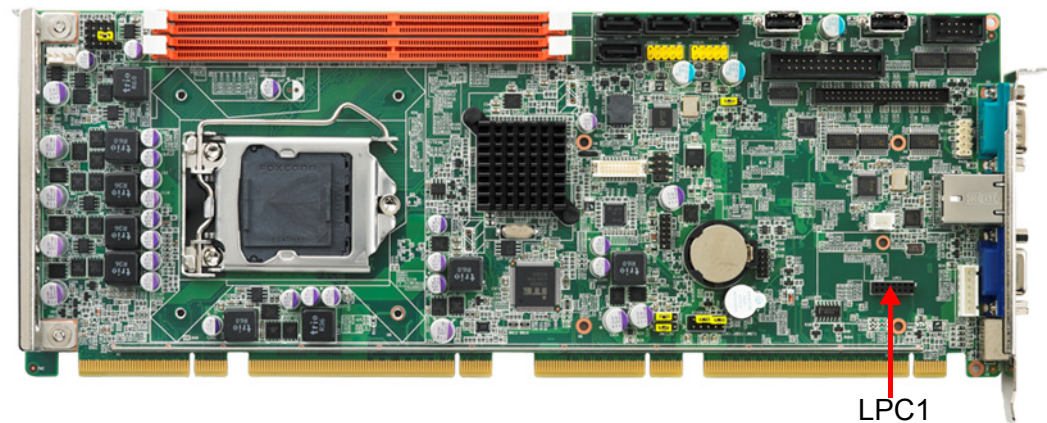
## 2.15 Serial ATA Interface (SATA1~SATA4)



The PCE-5026 features high performance serial ATA interface (4\* 300MB/s) which eases cabling to hard drivers or CD/DVD drives with long cables.

**Note!** We recommend plugging in CD/DVD drives on SATA3 and 4.  
 When you install Linux OS, we recommend you to set AHCI mode in BIOS setting, otherwise the system may not recognize hard drives (using IDE mode) during Linux OS installation.

## 2.16 LPC Extension Interface (LPC1)



LPC1 is a 14-pin female pinheader for adopting for adopting Advantech LPC module.

# Chapter 3

AMI BIOS Setup

## 3.1 Introduction

AMI BIOS has been integrated into motherboards for over a decade. In the past, people often referred to the AMI BIOS setup menu as BIOS, BIOS setup or CMOS setup. With the AMI BIOS Setup program, you can modify BIOS settings and control the special features of your computer. The Setup program uses a number of menus for making changes and turning the special features on or off. This chapter describes the basic navigation of the PCE-5026 setup screens.

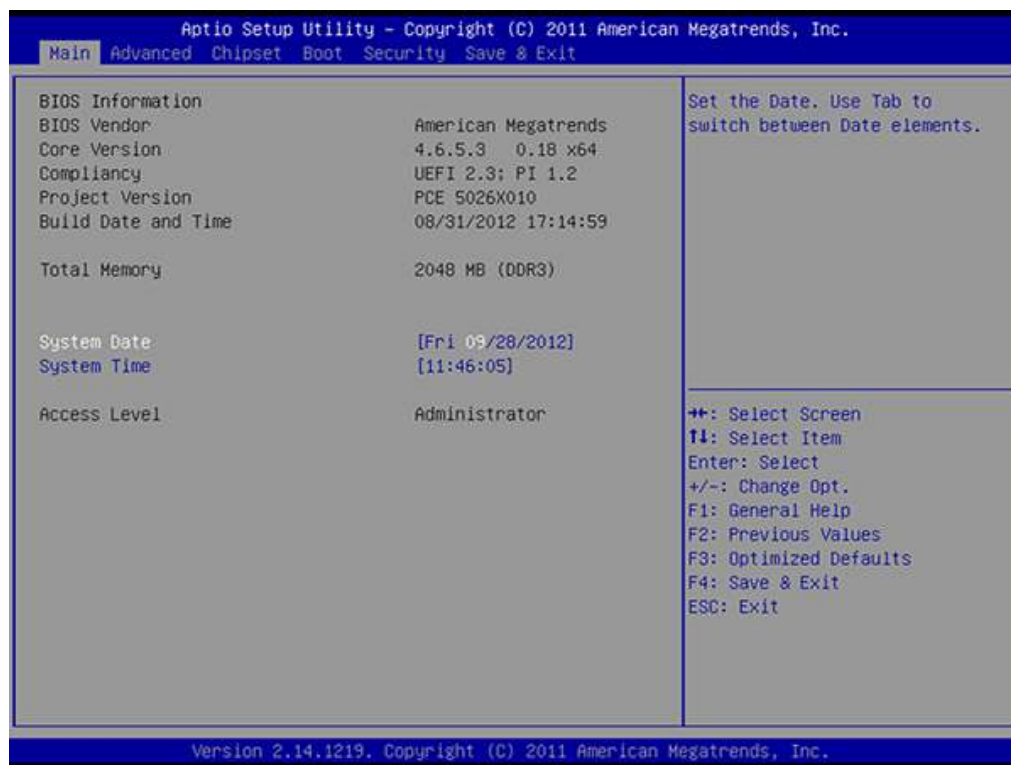


Figure 3.1 Setup Program Initial Screen

## 3.2 Entering Setup

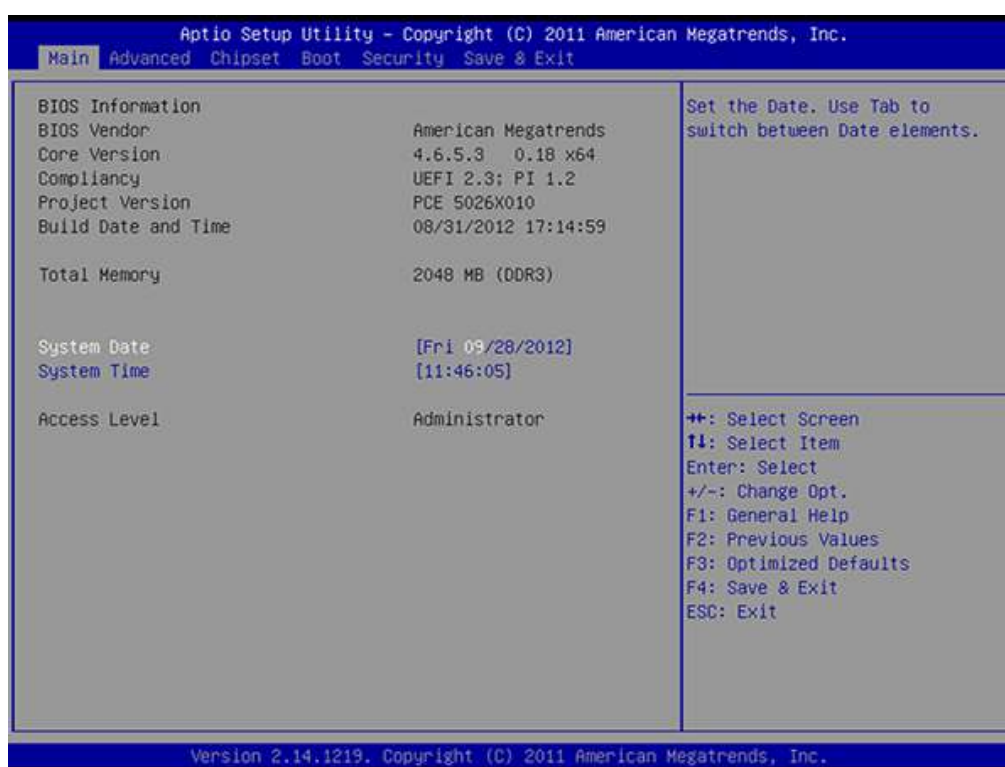
Turn on the computer and activate BIOS as well. The setup program is triggered by pressing “DEL” or “F2” key.

**Note!** *If the message disappears before you press the “DEL” or “F2” key, please restart the computer and try it again.*



### 3.2.1 Main Setup

When you first enter the BIOS Setup Utility, you will enter the Main setup screen. You can always return to the Main setup screen by selecting the Main tab. There are two Main Setup options. They are described in this section. The Main BIOS Setup screen is shown below.



**Figure 3.2 Main Setup Screen**

The Main BIOS setup screen has two main frames. The left frame displays all the options that can be configured. Grayed-out options cannot be configured; options in blue can. The right frame displays the key legend.

Above the key legend is an area reserved for a text message. When an option is selected in the left frame, it is highlighted in white. Often a text message will accompany it.

#### ■ System Time / System Date

Use this option to change the system time and date. Highlight System Time or System Date using the <Arrow> keys. Enter new values through the keyboard. Press the <Tab> key or the <Arrow> keys to move between fields. The date must be entered in MM/DD/YY format. The time must be entered in HH:MM:SS format.

### 3.2.2 Advanced BIOS Features Setup

Select the Advanced tab from the PCE-5026 setup screen to enter the Advanced BIOS Setup screen. You can select any of the items in the left frame of the screen, such as CPU Configuration, to go to the sub menu for that item. You can display an Advanced BIOS Setup option by highlighting it using the <Arrow> keys. All Advanced BIOS Setup options are described in this section. The Advanced BIOS Setup screen is shown below, and the sub menus are described on the following pages.

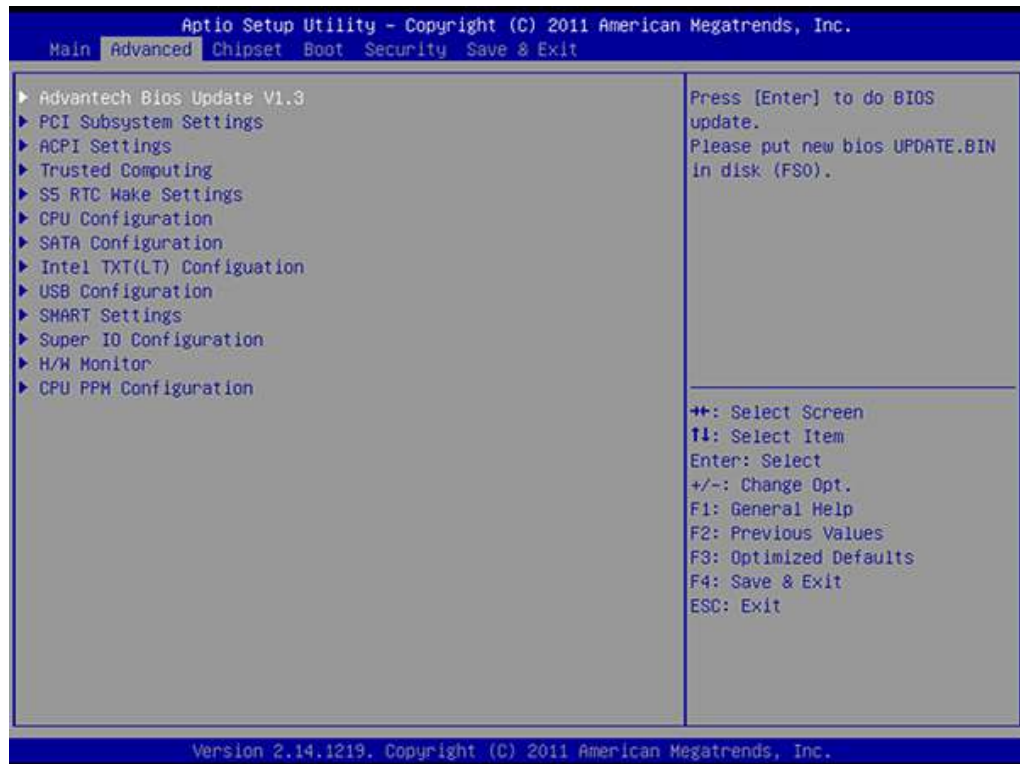
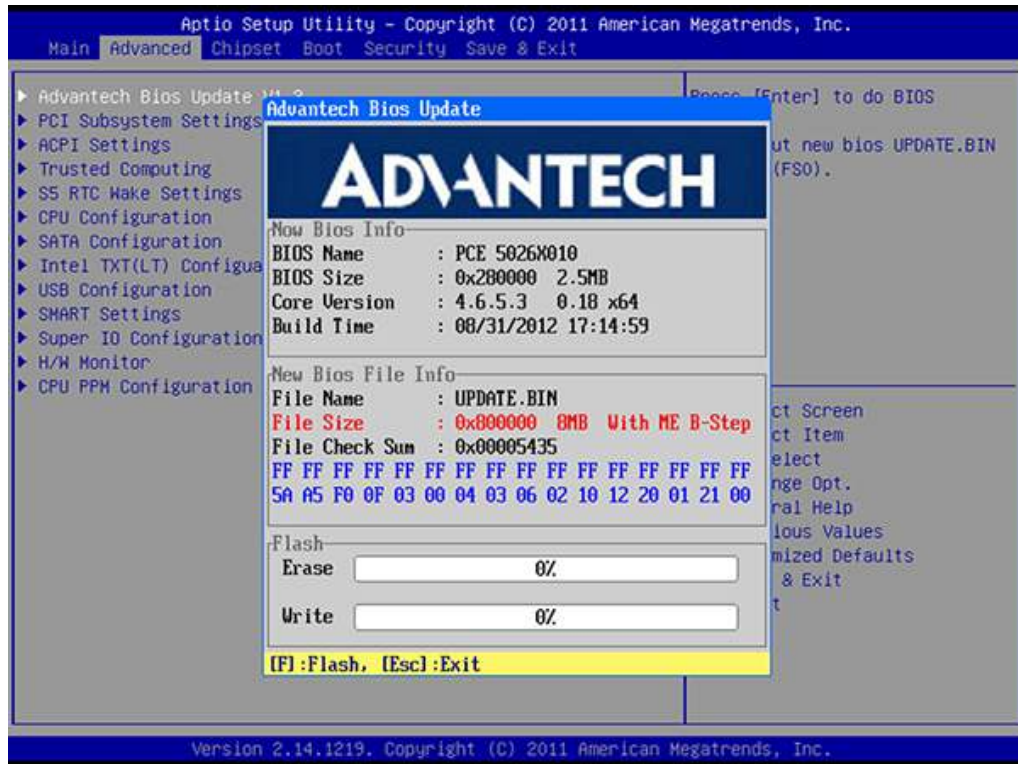


Figure 3.3 Advanced BIOS Features Setup Screen

### 3.2.2.1 Advantech BIOS Update V1.3



**Figure 3.4 Advantech BIOS Update V1.3**

You can update BIOS via USB storage device in FAT32 format.

**Note!** BIOS file name must be UPDATE.BIN.



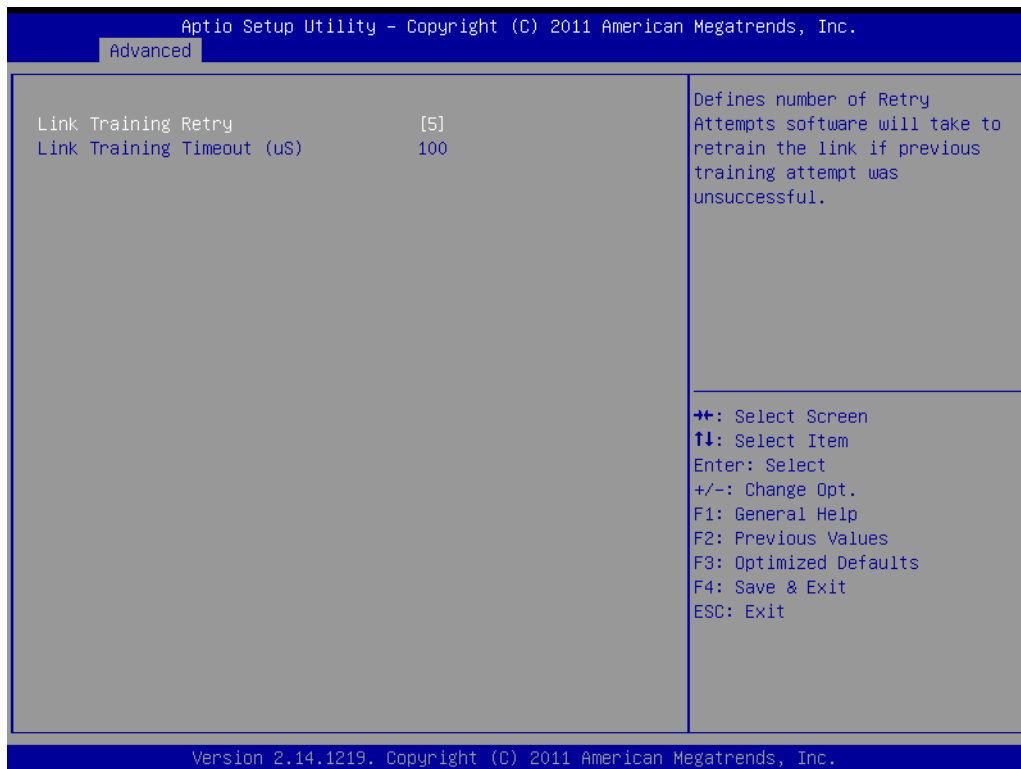
### 3.2.2.2 PCI Subsystem Settings



**Figure 3.5 PCI Subsystem Settings**

- **PCI 64-bit Resources Handling Above 4G Decoding**  
Enable/Disable 64-bit capable devices to be decoded above 4G address space (only if system supports 64-bit PCI decoding).
- **PCI Common Settings**
  - PCI Latency Timer**  
Value to be programmed into PCI Latency Timer Register.
  - VGA Palette Snoop**  
Enables/Disables VGA palette registers snooping.

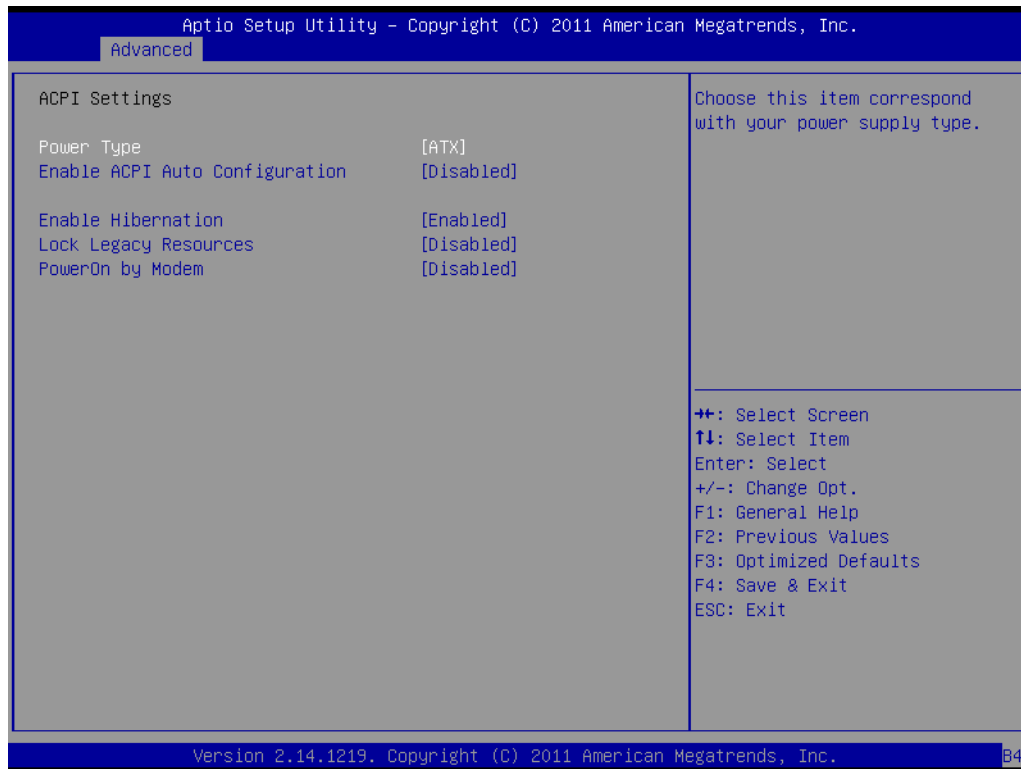




**Figure 3.6 PCI Express Settings**

- **Link Training Retry**  
Defines number of retry attempts software will take to retrain the link if previous training attempt was unsuccessful.
- **Link Training Timeout**  
Defines number of micro-seconds software will wait before polling “Link Training” bit in link status register. Value range from 10 to 1000 uS.

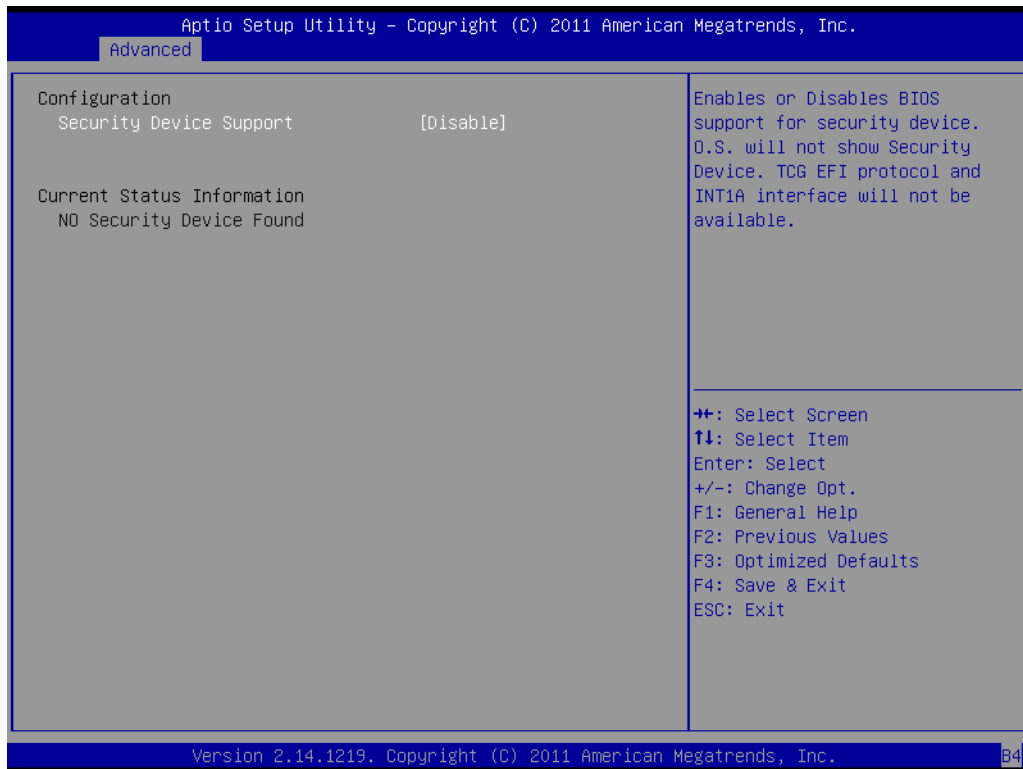
### 3.2.2.3 ACPI Settings



**Figure 3.7 ACPI Settings**

- **Power Type**  
Choose the item that corresponds with your power supply type, ATX or AT.
- **Enable ACPI AUTO configuration**  
Enable or disable ACPI auto configuration
- **Enable Hibernation**  
Enable or disable Hibernate (OS/S4 Sleep State). This option may not be effective with some OSs.
- **Lock Legacy Resources**  
Enable or Disable Lock Legacy Resources.
- **PowerOn by Modem**  
Enable or Disable Power On by Modem

### 3.2.2.4 Trust Computing



**Figure 3.8 Trust Computing**

- **Security Device Support**

Enable or disable BIOS support for security device. You can purchase Advantech's TPM (Trust Platform Module), PCA-TPM-00A1E, for your security device.

### 3.2.2.5 S5 RTC Wake Setting



Figure 3.9 S5 RTC Configuration

- **Wake System with Fixed Time**

Enable or disable system wake on alarm event, When enabled, system will wake on the hr:min:sec specified.

### 3.2.2.6 CPU Configuration

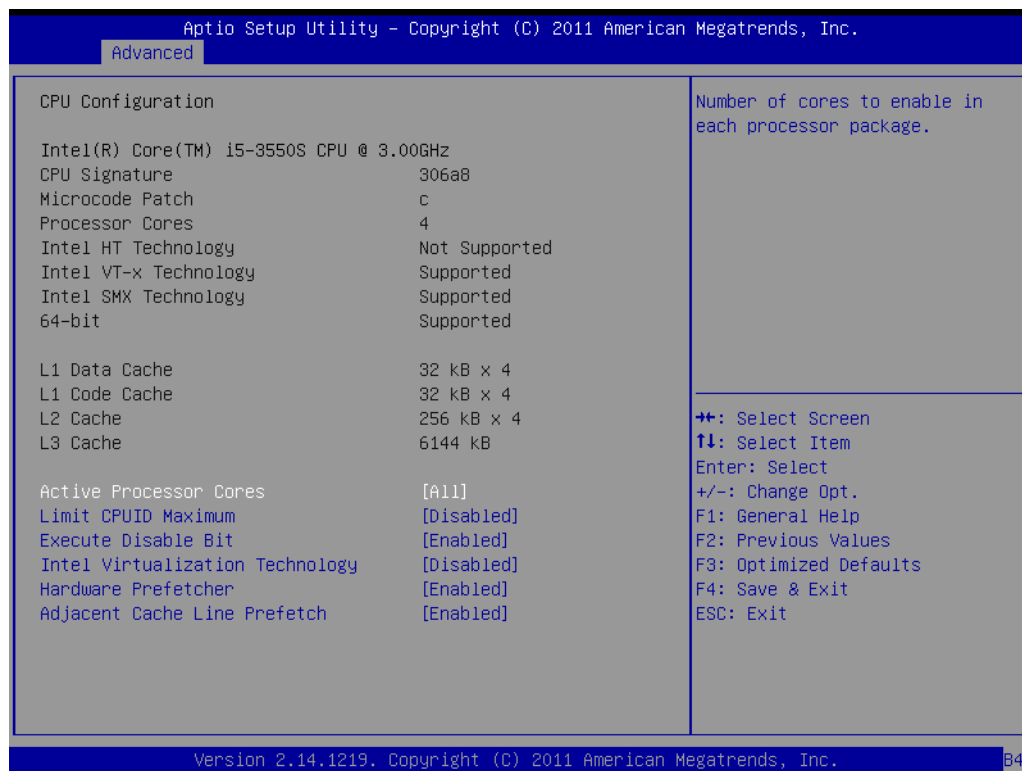


Figure 3.10 CPU Configuration

- **Active Processor Core**  
Use this to select how many processor cores you want to activate when you are using a dual or quad core processor.
- **Limit CPUID Maximum**  
Setting this item to [Enable] allows legacy operating systems to boot even without support for CPUs with extended CPUID functions.
- **Execute Disable Bit**  
This item specifies the Execute Disable Bit Feature. The settings are Enabled and Disabled. The Optimal and Fail-Safe default setting is Enabled. If Disabled is selected, the BIOS forces the XD feature flag to always return to 0.
- **Intel Virtualization Technology**  
This feature is used to enable or disable the Intel Virtualization Technology (IVT) extension. It allows multiple operating systems to run simultaneously on the same system. It does this by creating virtual machines, each running its own x86 operating system.
- **Hardware Prefetcher**  
Hardware Prefetcher is a technique that fetches instructions and/or data from memory into the CPU cache memory well before the CPU needs it, so that it can improve the load-to-use latency. You may choose to enable or disable it.
- **Adjacent Cache Line Prefetch**  
The Adjacent Cache-Line Prefetch mechanism, like automatic hardware prefetch, operates without programmer intervention. When enabled through the BIOS, two 64-byte cache lines are fetched into a 128-byte sector, regardless of whether the additional cache line has been requested or not. You may choose to enable or disable it.

### 3.2.2.7 SATA Configuration

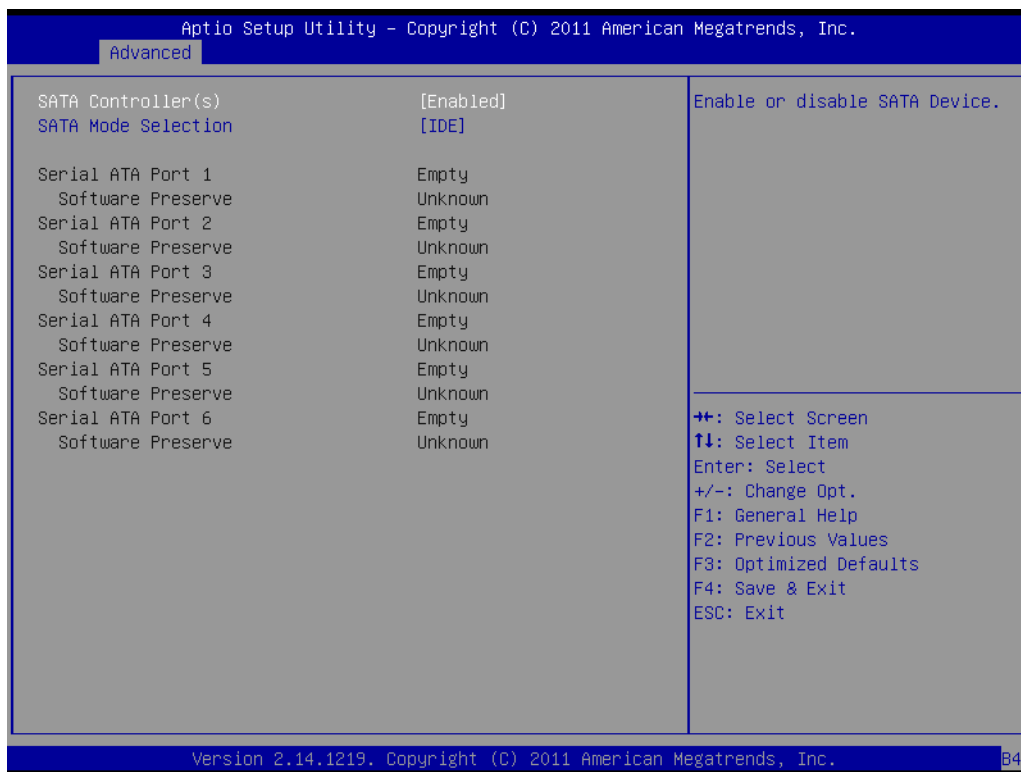


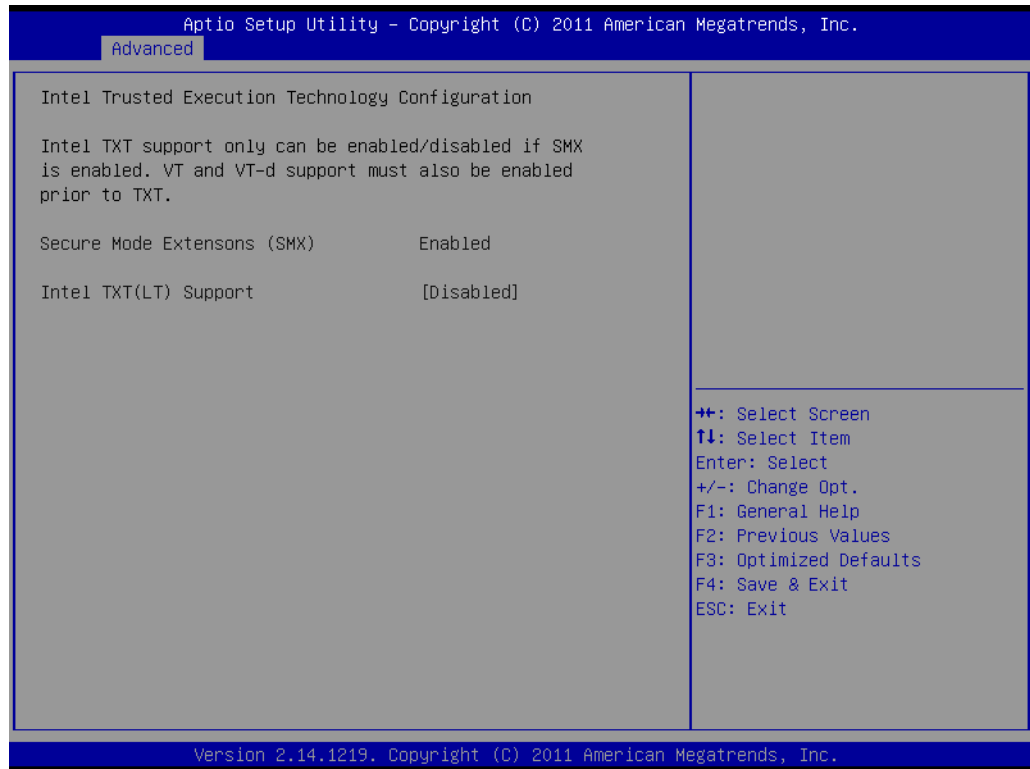
Figure 3.11 SATA Configuration

- **SATA Controller(s)**  
Enable or disable SATA Device
- **SATA Mode**  
This can be configured as IDE and AHCI.

**Note!** *Some Operating systems request to install under AHCI mode. Please consult local OS agent for detailed information. For example, Fedora 14/15/16 should be installed under AHCI mode.*



### 3.2.2.8 Intel Trusted Execution Technology Configuration



**Figure 3.12 Intel Trusted Execution Technology Configuration**

- **Intel Trusted Execution Technology Configuration**  
This enables or disables Intel® Trusted Execution Technology.

**Note!** *Hardware platform should support Trust Platform Module (TPM1.2) to enable Intel Trusted Execution Technology.*



*Advantech TPM module P/N: PCA-TPM-00A1E*

### 3.2.2.9 USB Configuration



Figure 3.13 USB Configuration

- **Legacy USB Support**  
This is for supporting USB devices under legacy OSs such as DOS. When choosing "AUTO," the system will automatically detect if any USB device is plugged into the computer and enable USB legacy mode when a USB device is plugged and disable USB legacy mode when no USB device is plugged.
- **EHCI Hand-off**  
This is a workaround for OSs without EHCI hand-off support. The EHCI ownership change should be claimed by EHCI driver.
- **USB Transfer Time-out**  
Allows you to select the USB transfer time-out value. [1, 5, 10, 20 sec]
- **Device Reset Time-out**  
Allows you to select the USB device reset time-out value. [1, 5, 10, 20 sec]
- **Device Power-up Delay**  
This item appears only when you set the Device power-up delay item to [manual].

### 3.2.2.10 Smart Settings

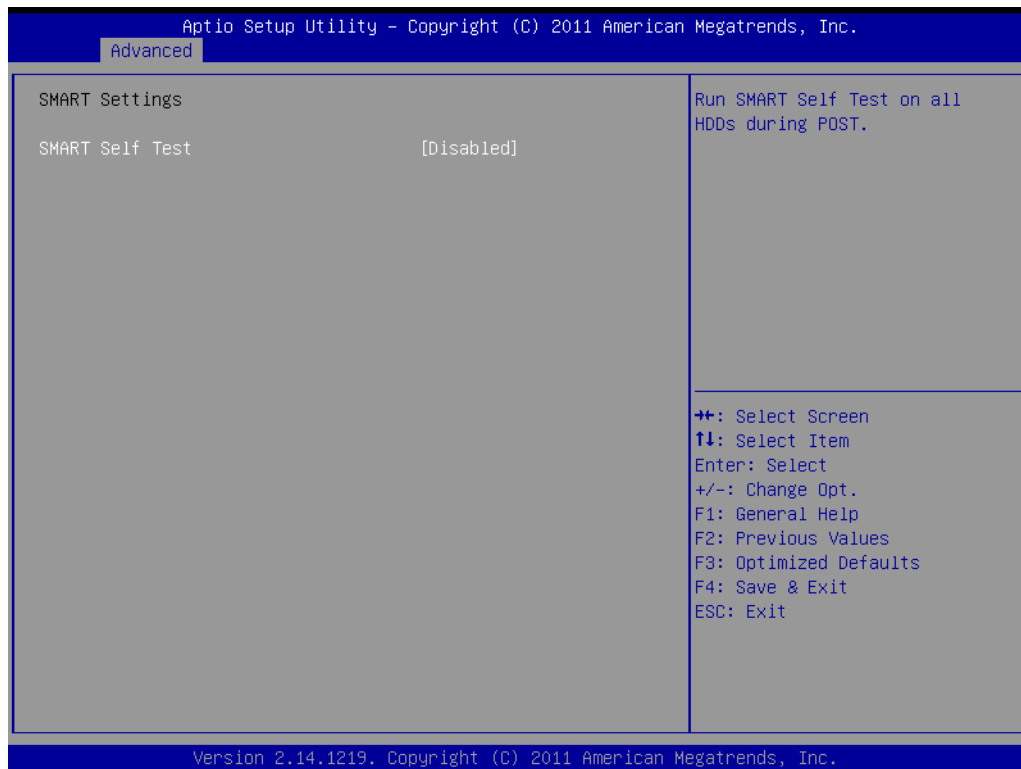


Figure 3.14 Smart Settings

- **Smart Self test**  
Run SMART Self Test on all HDDs during POST.

### 3.2.2.11 Super I/O Configuration

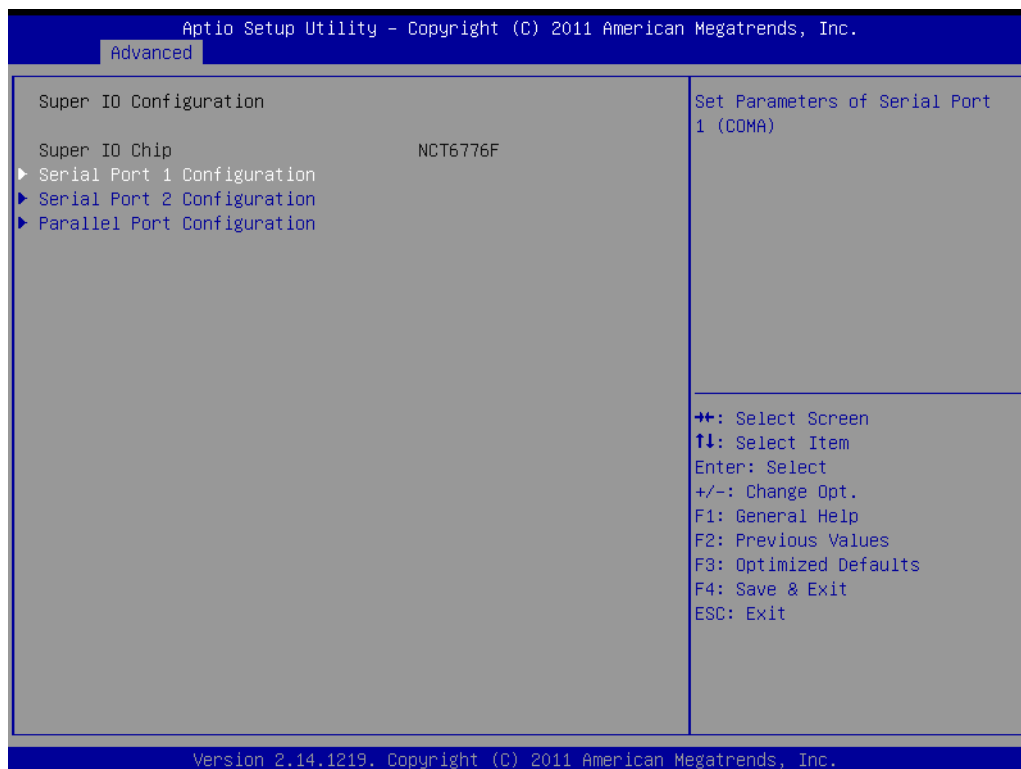


Figure 3.15 Super I/O Configuration



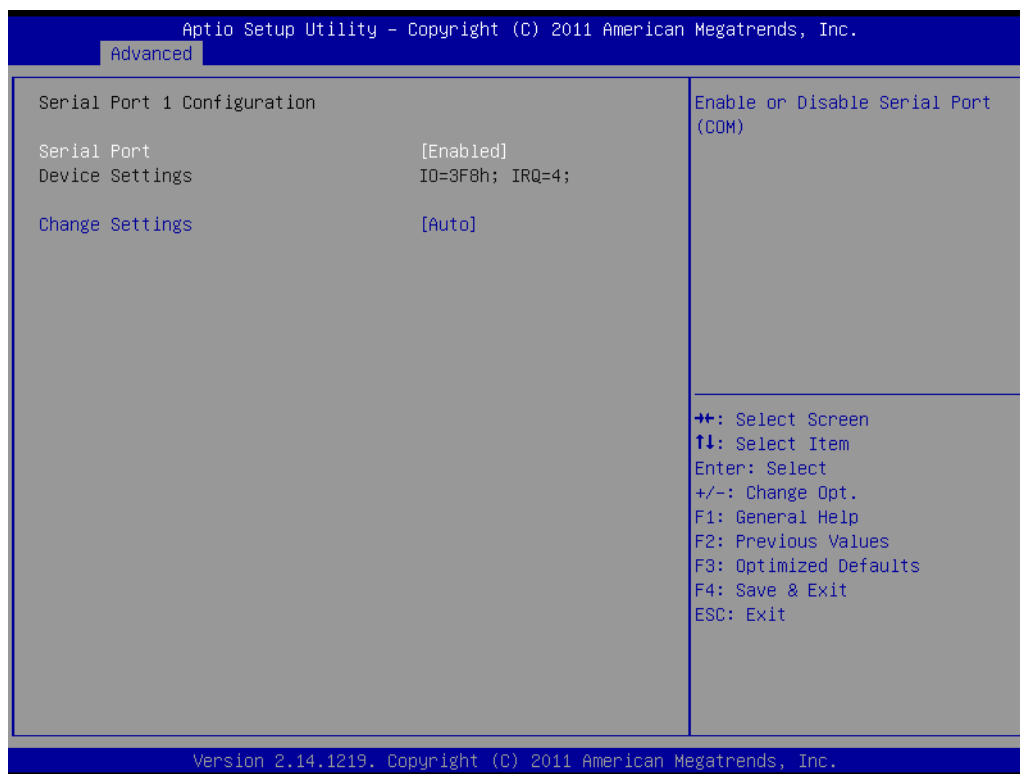


Figure 3.16 Serial Port 1 Configuration

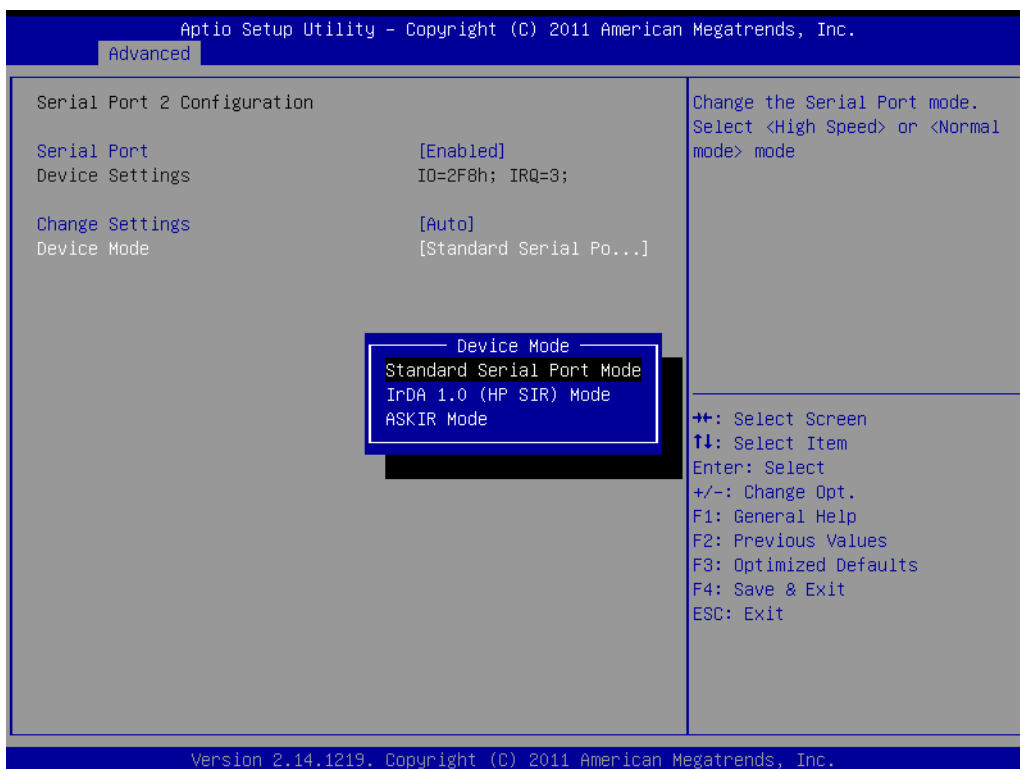
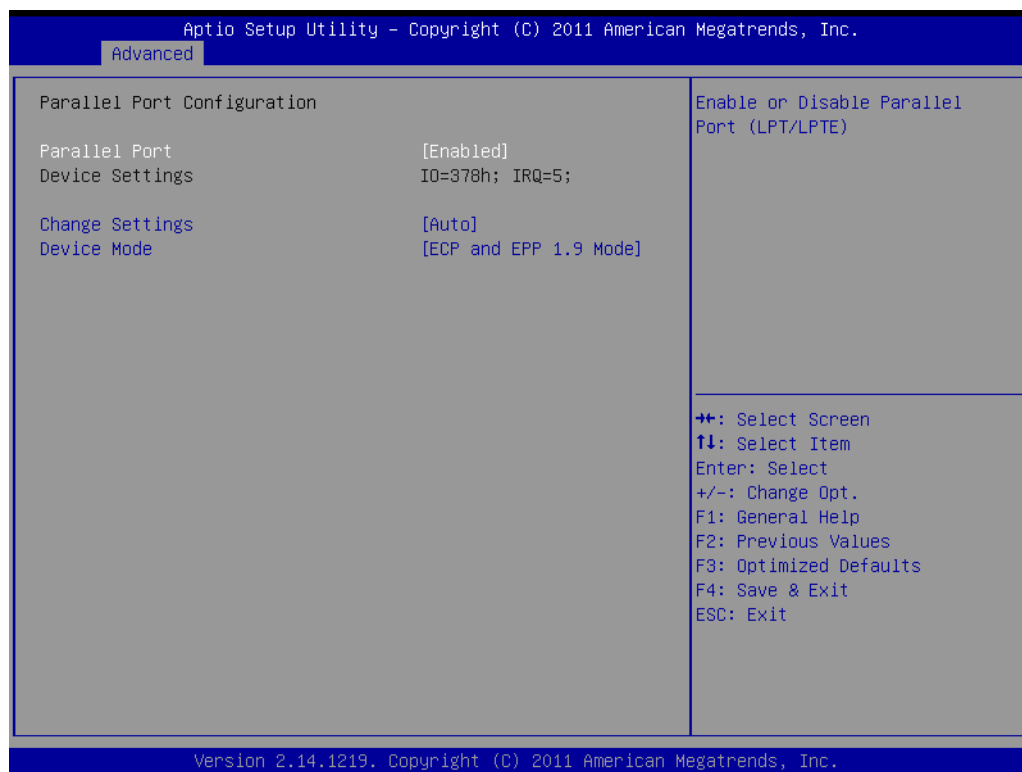


Figure 3.17 Serial Port 2 Configuration



**Figure 3.18 Parallel Configuration**

- **Serial Port 1 -2 Configuration**

“Enable” or “Disable” Serial Port

**Note!** *Only serial port 2 can be configured to IrDA or ASKIR mode via BIOS setting menu.*



- **Parallel Port Configuration**

“Enable” or “Disable” Parallel Port

## 3.2.2.12 H/W Monitor

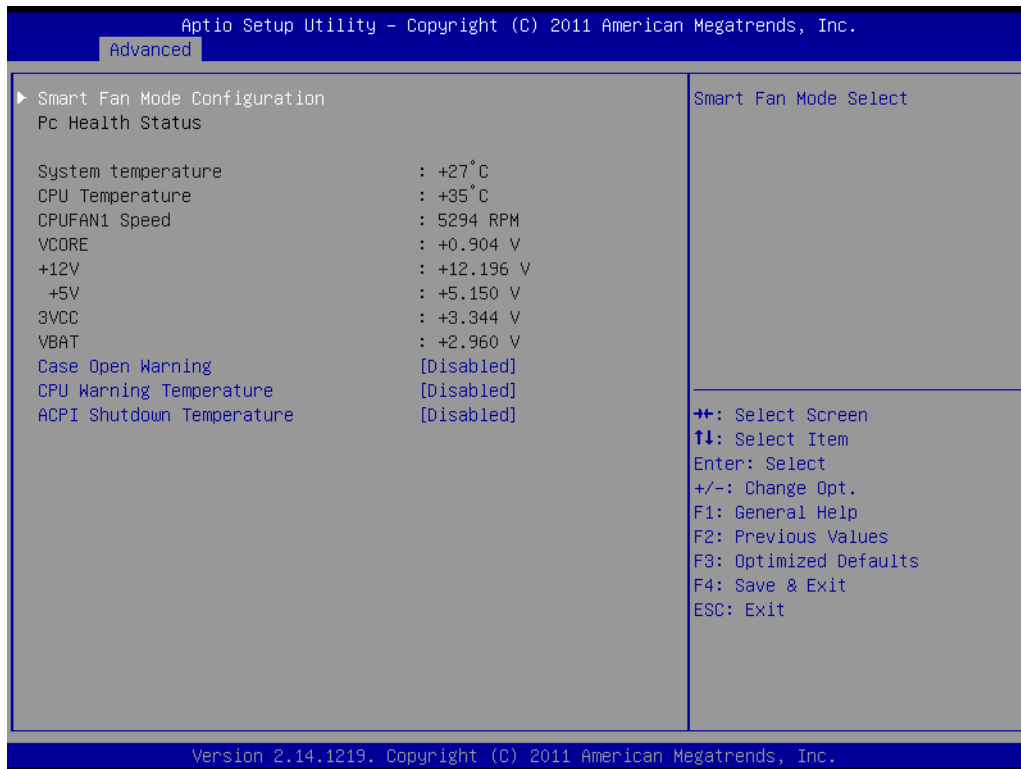


Figure 3.19 PC Health Status

- **Smart Fan Mode Configuration**  
Enable or disable Smart fan
- **Case Open Warning**  
Enable/Disable the Chassis Intrusion monitoring function. When enabled and the case is opened, the speaker beeps.
- **CPU Warning Temperature**  
Use this to set the CPU warning temperature threshold. When the system reaches the warning temperature, the speaker will beep.
- **ACPI Shutdown Temperature**  
Use this to set the ACPI shutdown temperature threshold. When the system reaches the shutdown temperature, it will be automatically shut down by ACPI OS to protect the system from overheating damage.

### 3.2.2.13 CPU PPM Configuration

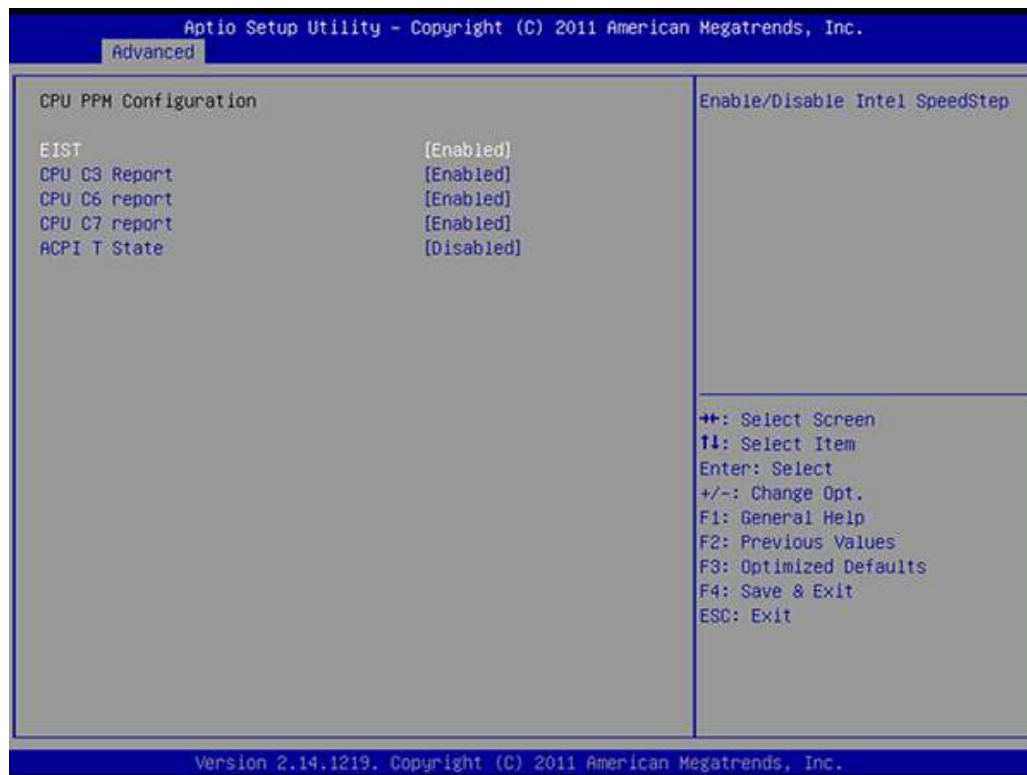


Figure 3.20 CPU PPM Configuration

- **EIST**  
Enable/Disable Intel Speedstep
- **CPU C3 Report**  
Enable/Disable CPU C3 (ACPI C2) report to OS.
- **CPU C6 Report**  
Enable/Disable CPU C6 (ACPI C2) report to OS.
- **CPU C7 Report**  
Enable/Disable CPU C7 (ACPI C2) report to OS.
- **ACPI T State**  
Enable/Disable ACPI T state support

### 3.2.3 Chipset

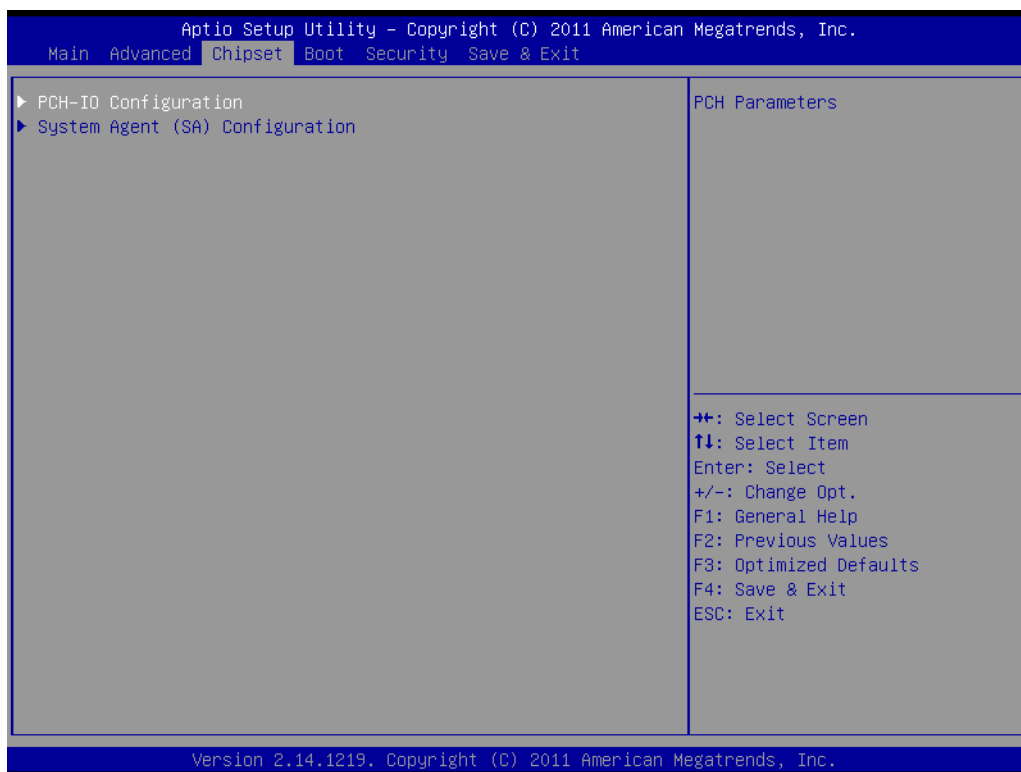


Figure 3.21 Chipset

#### 3.2.3.1 PCH-I/O Configuration

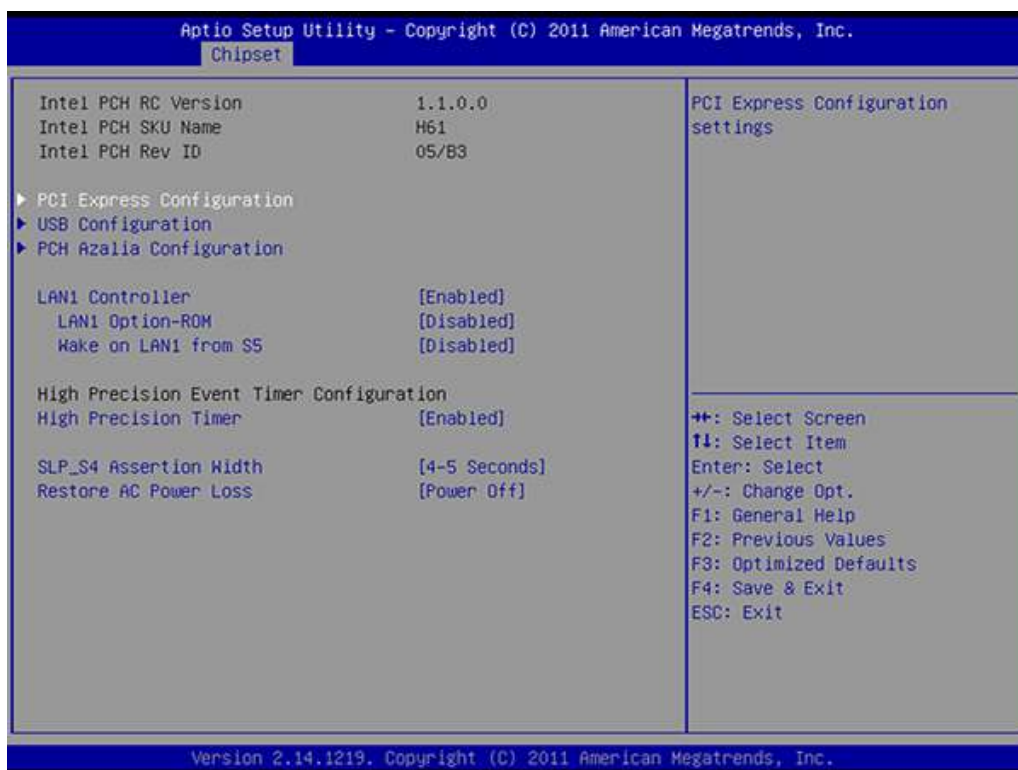
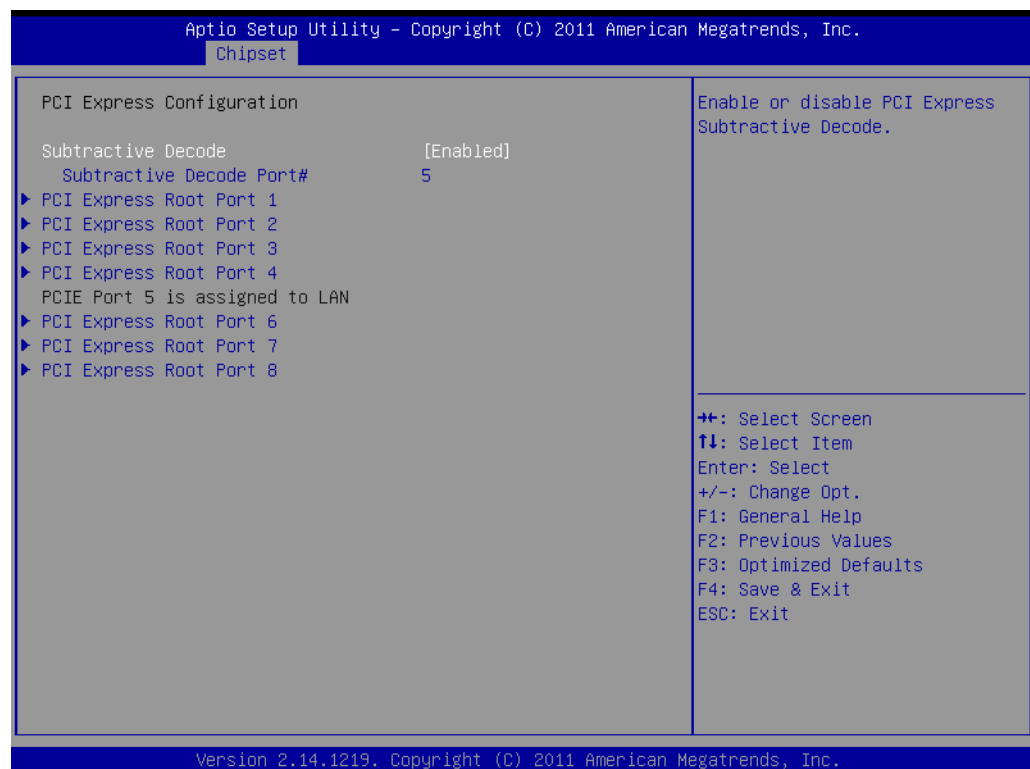


Figure 3.22 PCH I/O Configuration

- **LAN1 Controller**  
Enable or Disable LAN1 Controller.

- **LAN 1 Option-ROM**  
Enable or Disable LAN 1 boot option for legacy network devices.
- **Wake on LAN1 from S5**  
Enable or Disable LAN1 to wake the system. (The wake on LAN cannot be disabled if ME is on at Sx state).
- **High precision Timer**  
Enable or Disable High Precision Event Timer.
- **SLP\_S4 Assertion Width**  
Select a minimum assertion width of the SLP\_S4# signal.
- **Restore AC Power Loss**  
Power Off, power On or Last State to restore AC power loss

### 3.2.3.2 PCI Express Configuration



**Figure 3.23 PCI Express Configuration**

- **Subtractive Decode**  
Enable or disable PCI Express Subtractive Decode.
- **PCI Express Configuration**  
PCI Express Root Port 1 to 8 Setting.

### 3.2.3.3 USB Configuration

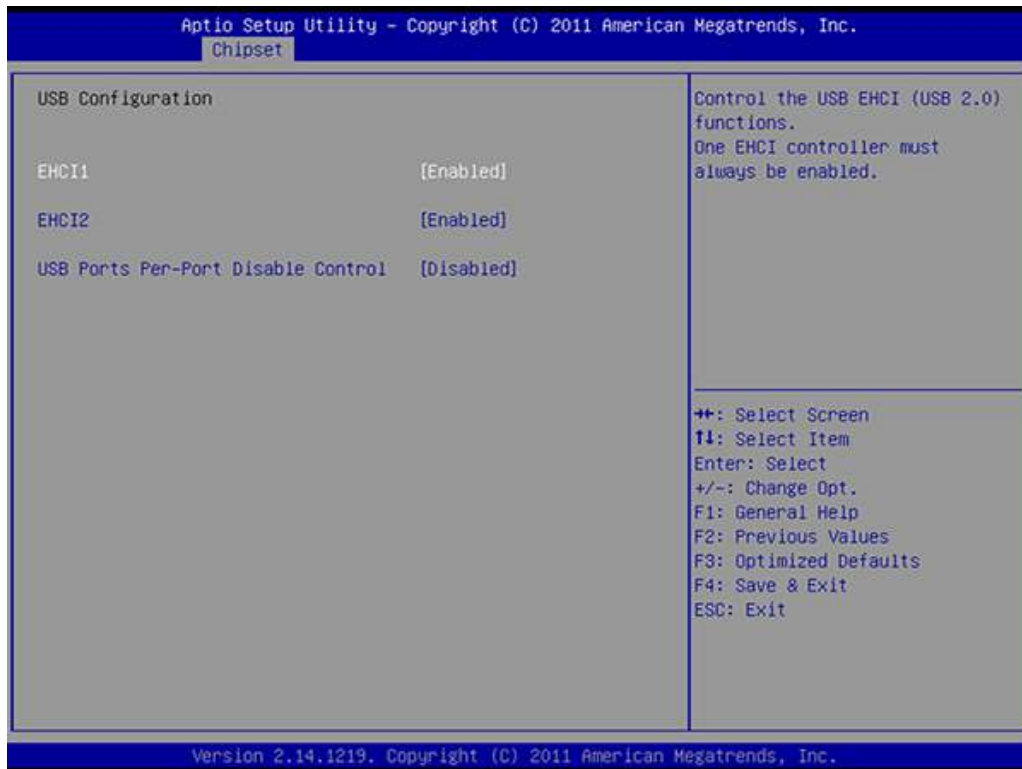
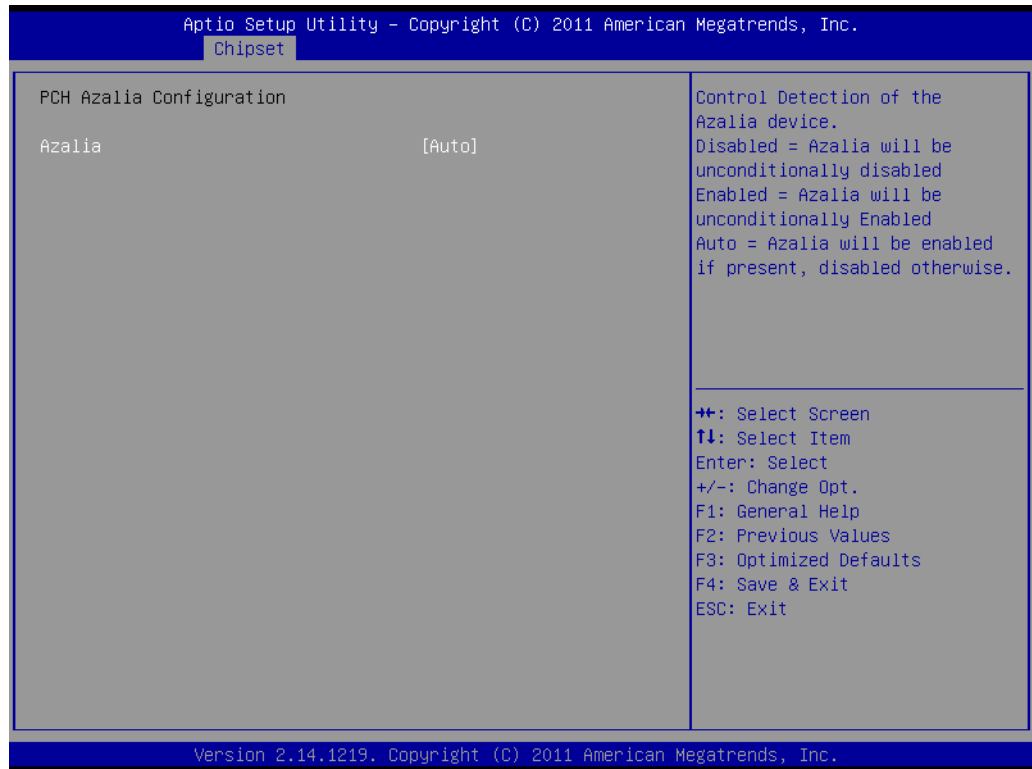


Figure 3.24 USB Configuration

- **EHCI1**  
Control the USB EHCI(USB2.0) functions. One EHCI controller must always be enabled.
- **EHCI2**  
Control the USB EHCI(USB2.0) functions. One EHCI controller must always be enabled.
- **USB Ports Per-port Disable Control**  
Control each of the USB ports disabling.

### 3.2.3.4 PCH Azalia Configuration

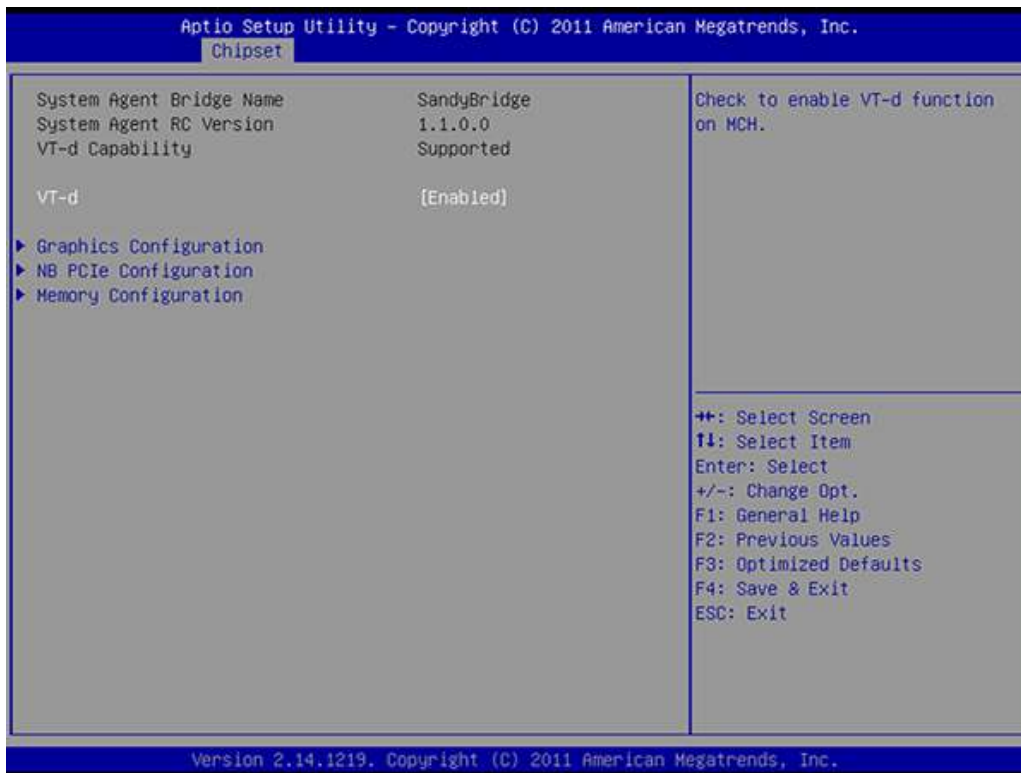


**Figure 3.25 PCH Azalia Configuration**

- **Azalia**  
Control detection of the Azalia device.  
Disable=Azalia will be disabled  
Enable=Azalia will be enabled  
Auto=Azalia will be enabled if present, disabled otherwise.



### 3.2.3.5 System Agent (SA) Configuration



**Figure 3.26 System Agent (SA) Configuration**

- **VT-d**  
Check to enable VT-d function on MCH

### 3.2.3.6 Graphics Configuration

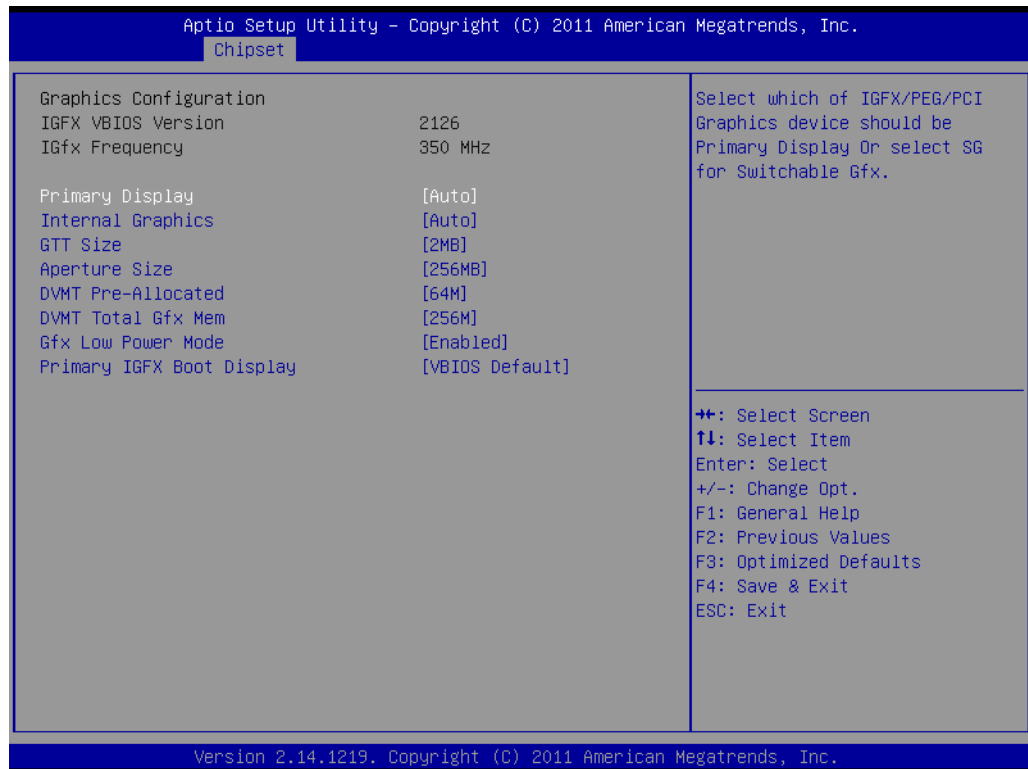
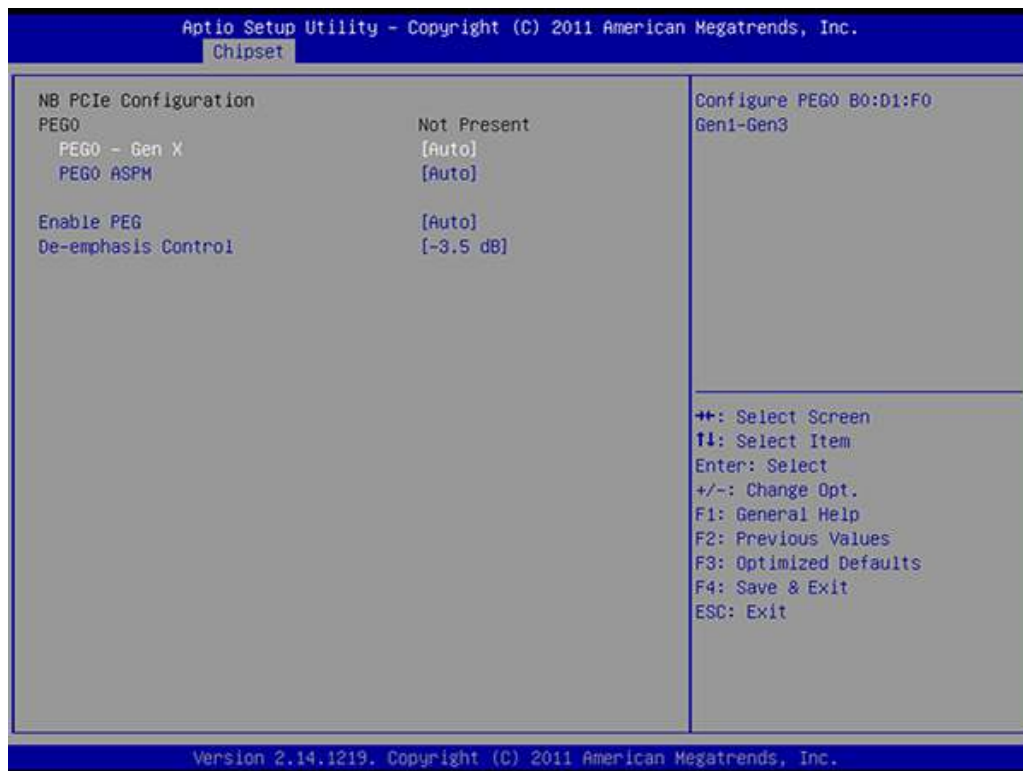


Figure 3.27 Graphics Configuration

- **Primary Display**  
Select which of IGFX/PEG/PCI Graphics device should be Primary display or select SG for switchable Gfx.
- **Internal Graphics**  
Keep IGD enabled based on the setup options.
- **GTT Size**  
Select the GTT size.
- **Aperture Size**  
Select the aperture size.
- **DVMT Pre-Allocated**  
Select DVMT5.0 Pre-allocated (fixed) graphics memory size, up to 1024 M, used by the internal graphics device.
- **DVMT Total Gfx Mem**  
Select 128 M, 256 M or MAX DVMT5.0 total graphics memory size used by the internal graphics device.
- **Gfx Low Power Mode**  
This option is applicable for SFF only.
- **Primary IGFX Display**  
Select the video device which will be activated during POST. This has no effect if external graphics present. Secondary boot display selection will appear based on your selection. VGA modes will be supported only on primary display. Note: DOS mode only supports either VGA or DVI single output.

### 3.2.3.7 NB PCIe Configuration



**Figure 3.28 NB PCIe Configuration**

- **PEG0-Gen X**  
Configure auto, Gne1, Gen2, or Gen 3.
- **PEG0 ASPM**  
Control ASPM support for the PEG: Device 1 Function 0. This has no effect if PEG is not the currently active device.
- **Enable PEG**  
Enable/Disable/Auto the PEG.
- **De-emphasis Control**  
Configure the De-emphasis control on PEG

### 3.2.3.8 Memory Configuration

Overview of detailed memory information.

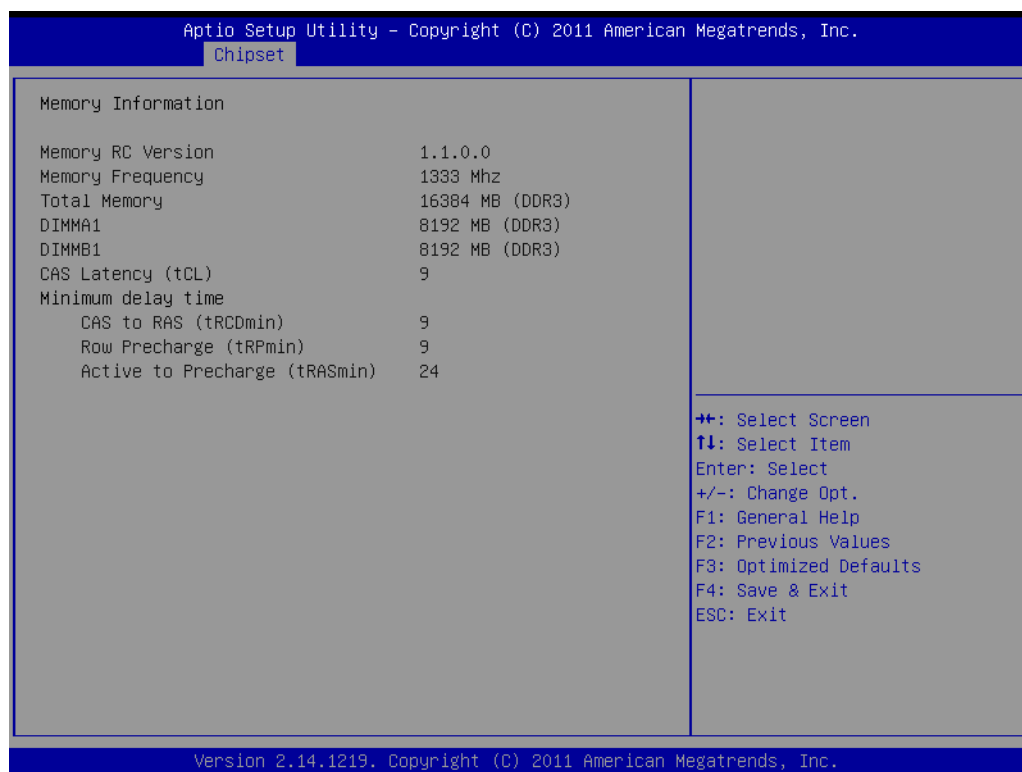


Figure 3.29 Memory Information

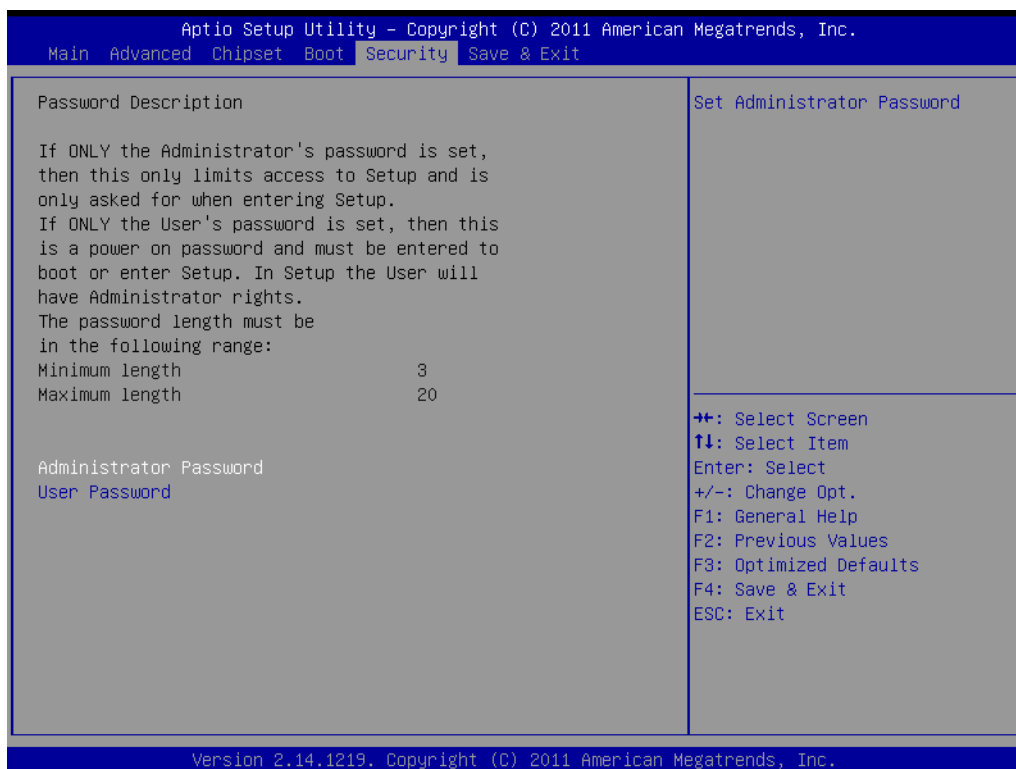
### 3.2.4 Boot



Figure 3.30 Boot

- **Setup Prompt timeout**  
Number of seconds to wait for setup activation key.
- **Bootup NumLock State**  
Select the keyboard Numlock state.
- **Quiet Boot**  
Enable/Disable Quiet Boot option.
- **GateA20 Active**  
Upon request-GA20 can be disabled using BIOS services.  
Always-do not allow disabling GA20; this option is useful when any RT code is executed above 1 MB.
- **Option Rom Messages**  
Set display mode for option ROM.
- **INT19 Trap Response**  
Bios reaction on INT19 trapping via ROM option:  
IMMEDIATE-execute the trap right away  
POSTPONED-execute the trap during legacy boot.
- **Boot Option Priorities**  
you can see the information of boot priority option of devices.
- **Hard Drive BBS Priorities**  
Set the order of the legacy devices in this group.

### 3.2.5 Security



**Figure 3.31 Security**

Select Security Setup from the PCE-5026 Setup main BIOS setup menu. All Security Setup options, such as password protection and virus protection are described in this section. To access the sub menu for the following items, select the item and press <Enter>

## 3.2.6 Save & Exit

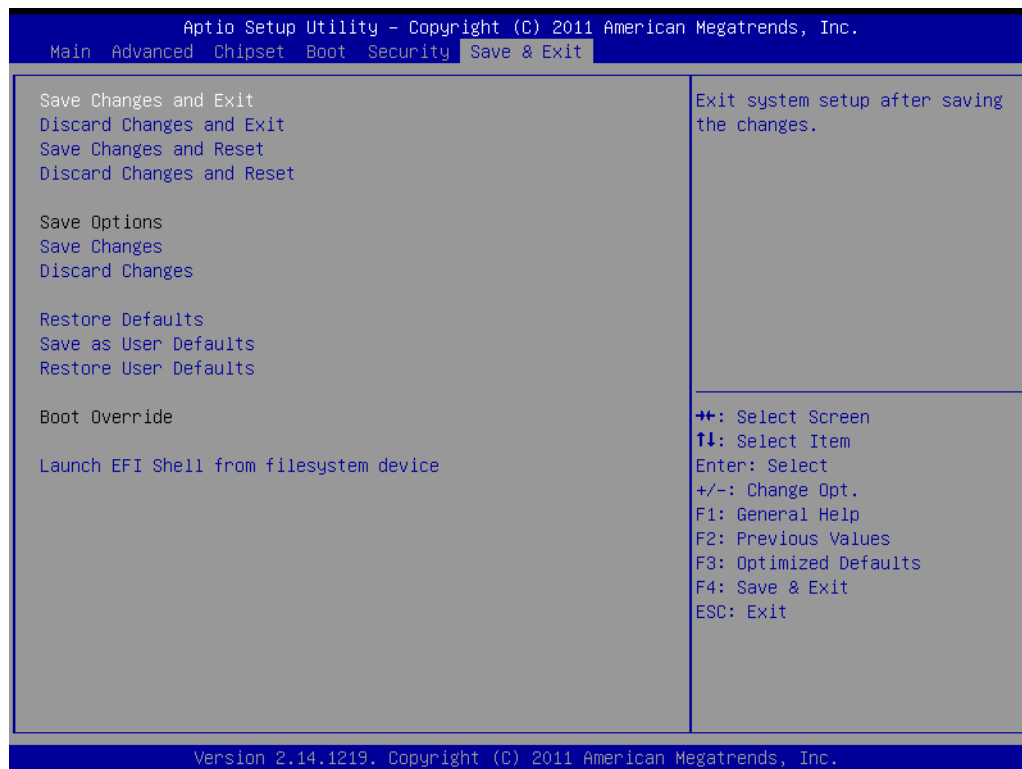


Figure 3.32 Save & Exit

### Save changes and exit\*

When you have completed system configuration, select this option to save your changes, exit BIOS setup and boot into the OS so the new system configuration parameters can take effect.

### Discard changes and exit

Select this option to quit Setup without making any permanent changes to the system configuration.

### Save changes and Reset

When you have completed system configuration, select this option to save your changes, exit BIOS setup and reboot into the computer so the new system configuration parameters can take effect.

### Discard changes and Reset

Select this option to quit Setup and reset computer without making any permanent changes to the system configuration.

### Save Changes

Select this option to save your changes.

### Discard Changes

Select this option to discard your changes.

**Restore Defaults**

Select this option to restore BIOS configuration to original.

**Save as User Defaults**

Select this option to save user configuration.

**Restore User Defaults**

Select this option to restore BIOS to user configuration.

**Launch EFI Shell from file system device**

This option allows you to attempt to launch the EFI Shell application (shellx64.efi) from one of the available file system devices.

\*When you do some critical changes, the system will still reboot even you choose "Save changes and exit."





# Chapter 4

Chipset Software  
Installation Utility

## 4.1 Before You Begin

To facilitate the installation of the enhanced display drivers and utility software, read the instructions in this chapter carefully. The drivers for the PCE-5026 are located on the software installation CD. The driver in the folder of the driver CD will guide and link you to the utilities and drivers under a Windows system. Updates are provided via Service Packs from Microsoft®.

**Note!** *The files on the software installation CD are compressed. Do not attempt to install the drivers by copying the files manually. You must use the supplied SETUP program to install the drivers.*



Before you begin, it is important to note that most display drivers need to have the relevant software application already installed in the system prior to installing the enhanced display drivers. In addition, many of the installation procedures assume that you are familiar with both the relevant software applications and operating system commands. Review the relevant operating system commands and the pertinent sections of your application software's user manual before performing the installation.

## 4.2 Introduction

The Intel® Chipset Software Installation (CSI) utility installs the Windows INF files that outline to the operating system how the chipset components will be configured. This is needed for the proper functioning of the following features:

- Core PCI PnP services
- Serial ATA interface support
- USB 1.1/2.0 support
- Identification of Intel® chipset components in the Device Manager
- Integrates superior video features. These include filtered sealing of 720 pixel DVD content, and MPEG-2 motion compensation for software DVD

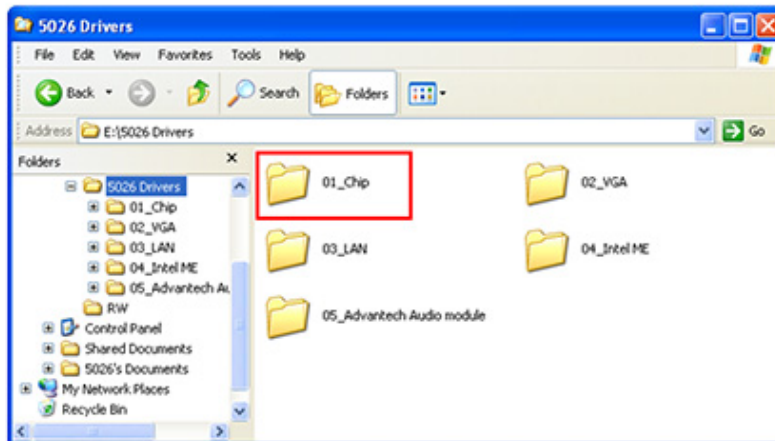
## 4.3 Windows® XP / Windows® 7 Driver Setup

- Insert the driver CD into your system's CD-ROM drive. You can see the driver folder items. Navigate to the "01-Chipset" folder and click "setup.exe" to complete the installation of the driver.

**Note!** *Wrong driver installation may cause unexpected system instability.*



*The drivers on this CD support both Windows XP 32-bit /64-bit and Windows 7 32-bit/64-bit.*





# Chapter 5

Integrated Graphic  
Device Setup

## 5.1 Introduction

The Intel® LGA1155 CPUs have integrated graphics controllers. You need to install the VGA driver to enable this function, which includes the following features:

- **Optimized integrated graphic solution:** Intel Graphics Flexible Display Interface supports versatile display options and 32-bit 3D graphics engine. Dual independent display, enhanced display modes for widescreen flat panels for extend, twin, and clone dual display mode, and optimized 3D support deliver an intensive and realistic visual experience.

## 5.2 Windows XP/Windows 7 Driver Setup

**Note!** Before installing this driver, make sure the INF driver has been installed on your system. See Chapter 4 for information on installing the INF driver.



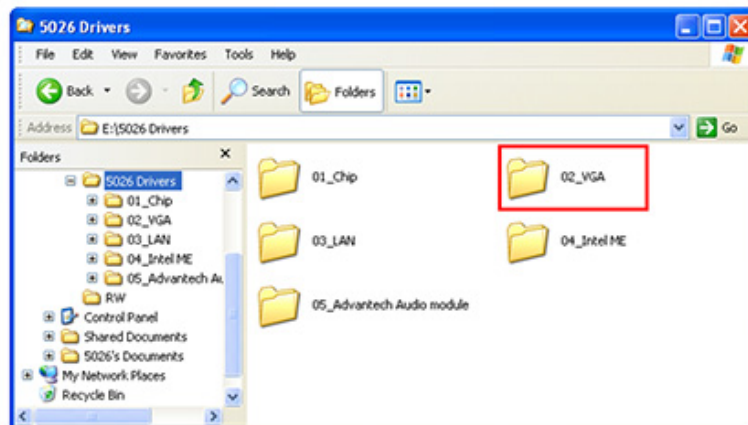
Insert the Advantech driver DVD into your system and navigate to folder named “02\_VGA” to choose proper operating system, then install driver by clicking “setup.exe” or “install.exe.”

**Note!** Wrong driver installation may cause unexpected system instability.



Intel VGA driver for Windows XP does not support Microsoft Direct X 10 and 11.

Only Intel Generation 3 CPUs (Ivybridge) support Microsoft Direct X11 in Windows 7.



# Chapter 6

## LAN Configuration

## 6.1 Introduction

PCE-5026 features single Gigabit Ethernet via dedicated Intel 82579V which offers 500 Mbps bandwidth, eliminating the bottleneck of network data flow and incorporating Gigabit Ethernet at 1000 Mbps.

## 6.2 Features

- 10, 100, 1000 BASE-T IEEE 802.3 specification conformance.
- Jumbo Frames support (up to 9 kB)
- Wake on LAN (WoL) support

## 6.3 Installation

**Note!** *Before installing the LAN drivers, make sure the Intel CSI utility has been installed on your system. See Chapter 4 for information on installing the CSI utility.*

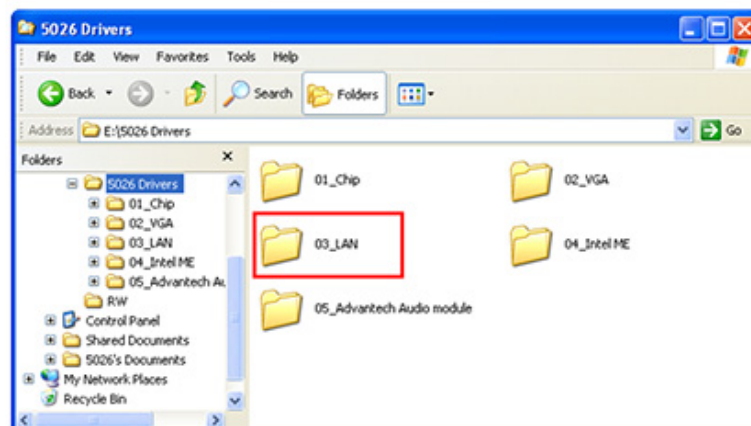


The PCE-5026's Intel 82579V (LAN1) Gigabit integrated controllers support all major network operating systems. However, the installation procedure varies from system to system. Please find and use the section that provides the driver setup procedure for the operating system you are using.

## 6.4 Win XP /Win 7 Driver Setup (LAN)

Insert the driver CD into your system's CD-ROM drive. Navigate to the "03-LAN" folder and click "Autorun.exe" to complete the installation of the driver.

**Note!** *Wrong driver installation may cause unexpected system instability.*





# Chapter 7

Intel ME

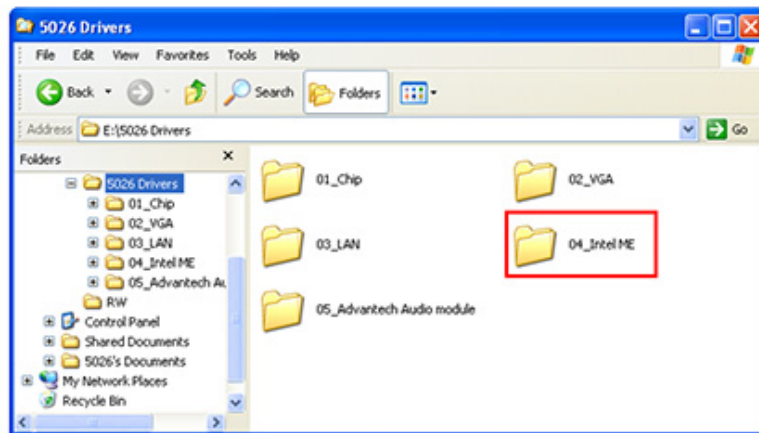
## 7.1 Introduction

The Intel® ME software components that need to be installed depend on the system's specific hardware and firmware features. The installer detects the system's capabilities and installs the relevant drivers and applications.

## 7.2 Installation

Insert the driver CD into your system's CD-ROM drive. Navigate to the "04-Intel ME" folder and click "setup.exe" to complete the installation of the driver.

**Note!** *If the Intel® Management Engine (Intel® ME) driver has not been successfully installed, you may see an error on a "PCI Simple Communications Controller" in Device Manager.*



# Appendix **A**

## Programming the Watchdog Timer

---

## A.1 Introduction

The PCE-5026's watchdog timer can be used to monitor system software operation and take corrective action if the software fails to function within the programmed period. This section describes the operation of the watchdog timer and how to program it.

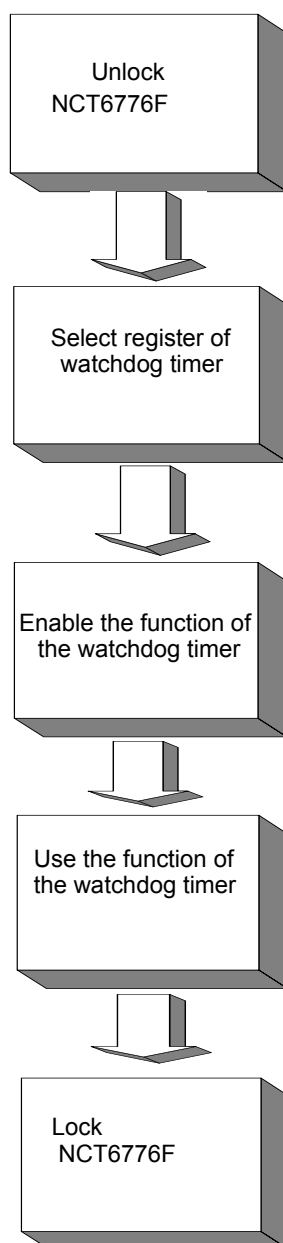
### A.1.1 Watchdog Timer Overview

The watchdog timer is built in to the NCT6776F super I/O controller. It provides the following user programmable functions:

- Can be enabled and disabled by user's program
- Timer can be set from 1 to 255 seconds or 1 to 255 minutes
- Generates reset signal if the software fails to reset the timer before time-out

### A.1.2 Programming the Watchdog Timer

The I/O port address of the watchdog timer is 2E (hex) and 2F (hex). 2E (hex) is the address port. 2F (hex) is the data port. You must first write an address value into address port 2E (hex), then write/read data to/from the assigned register through data port 2F (hex).


**Table A.1: Watchdog Timer Registers**

Address of register (2E)	Attribute Read/Write	Value (2F) & description
87 (hex)	-----	Write this address to I/O address port 2E (hex) twice to unlock the NCT6776F
07 (hex)	write	Write 08 (hex) to select register of watchdog timer.
30 (hex)	write	Write 01 (hex) to enable the function of the watchdog timer. Disabled is set as default.
F5 (hex)	write	Set seconds or minutes as units for the timer. Write 0 to bit 3: set second as counting unit. [default]. Write 1 to bit 3: set minutes as counting unit Write 1 to bit 4: Watchdog timer count mode is 1000 times faster. If bit 3 is 0, the count mode is 1/1000 seconds mode. If bit 3 is 1, the count mode is 1/1000 minutes mode.

F6 (hex)	write	0: stop timer [default] 01~FF (hex): The amount of the count, in seconds or minutes, depends on the value set in register F5 (hex). This number decides how long the watchdog timer waits for strobe before generating an interrupt or reset signal. Writing a new value to this register can reset the timer to count with the new value.
F7 (hex)	read/write	Bit 6: Write 1 to enable keyboard to reset the timer, 0 to disable.[default] Bit 5: Write 1 to generate a timeout signal immediately and automatically return to 0. [default=0] Bit 4: Read status of watchdog timer, 1 means timer is "timeout".
AA (hex)	----	Write this address to I/O port 2E (hex) to lock the NCT6776F.

### A.1.3 Example Program

1. Enable watchdog timer and set 10 sec. as timeout interval

```

;-----
Mov dx,2eh      ; Unlock NCT6776F
Mov al,87h
Out dx,al
Out dx,al
;-----
Mov al,07h      ; Select registers of watchdog timer
Out dx,al
Inc dx
Mov al,08h
Out dx,al
;-----
Dec dx          ; Enable the function of watchdog timer
Mov al,30h
Out dx,al
Inc dx
In al,dx
Or al,03h
Out dx,al
;-----
Dec dx          ; Set second as counting unit
Mov al,0f5h
Out dx,al
Inc dx
In al,dx
And al,not 08h
Out dx,al
;-----
Dec dx          ; Set timeout interval as 10 seconds and
start counting

```

```

Mov    al,0f6h
Out    dx,al
Inc    dx
Mov    al,10    ; 10 seconds
Out    dx,al
;-----
Dec    dx                ; Lock NCT6776F
Mov    al,0aah
Out    dx,al

2.  Enable watchdog timer and set 5 minutes as timeout interval
;-----
Mov    dx,2eh                ; Unlock NCT6776F
Mov    al,87h
Out    dx,al
Out    dx,al
;-----
Mov    al,07h                ; Select registers of watchdog timer
Out    dx,al
Inc    dx
In     al,dx
Or     al,08h
Out    dx,al
;-----
Dec    dx                ; Enable the function of watchdog timer
Mov    al,30h
Out    dx,al
Inc    dx
Mov    al,03h
Out    dx,al
;-----
Dec    dx                ; Set minute as counting unit
Mov    al,0f5h
Out    dx,al
Inc    dx
In     al,dx
Or     al,08h
Out    dx,al
;-----
Dec    dx                ; Set timeout interval as 5 minutes and
start counting
Mov    al,0f6h
Out    dx,al
Inc    dx
Mov    al,5    ; 5 minutes
Out    dx,al

```

```

;-----
Dec dx                ; Lock NCT6776F
Mov  al,0aah
Out  dx,al

3.  Enable watchdog timer to be reset by mouse
;-----
Mov dx,2eh           ; Unlock NCT6776F
Mov al,87h
Out dx,al
Out dx,al

;-----
Mov al,07h           ; Select registers of watchdog timer
Out  dx,al
Inc  dx
Mov  al,08h
Out  dx,al

;-----
Dec dx                ; Enable the function of watchdog timer
Mov  al,30h
Out  dx,al
Inc  dx
In   al,dx
Or   al,03h
Out  dx,al

;-----
Dec dx                ; Enable watchdog timer to be reset by
mouse
Mov  al,0f7h
Out  dx,al
Inc  dx
In   al,dx
Or   al,80h
Out  dx,al

;-----
Dec dx                ; Lock NCT6776F
Mov  al,0aah
Out  dx,al

4.  Enable watchdog timer to be reset by keyboard
;-----
Mov dx,2eh           ; Unlock NCT6776F
Mov al,87h
Out dx,al
Out dx,al

;-----

```



```

Mov al,07h          ; Select registers of watchdog timer
Out  dx,al
Inc  dx
Mov  al,08h
Out  dx,al
;-----
Dec dx              ; Enable the function of watchdog timer
Mov  al,30h
Out  dx,al
Inc  dx
Mov  al,03h
Out  dx,al
;-----
Dec dx              ; Enables watchdog timer to be strobe
reset by keyboard
Mov  al,0f7h
Out  dx,al
Inc  dx
In   al,dx
Or   al,40h
Out  dx,al
;-----
Dec dx              ; Lock NCT6776F
Mov  al,0aah
Out  dx,al

5. Generate a time-out signal without timer counting
;-----
Mov dx,2eh          ; Unlock NCT6776F
Mov al,87h
Out dx,al
Out dx,al
;-----
Mov al,07h          ; Select registers of watchdog timer
Out  dx,al
Inc  dx
Mov  al,08h
Out  dx,al
;-----
Dec dx              ; Enable the function of watchdog timer
Mov  al,30h
Out  dx,al
Inc  dx
Mov  al,03h
Out  dx,al
;-----

```

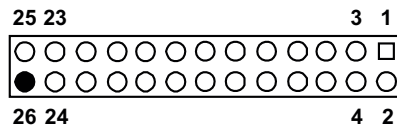
---

```
Dec dx                ; Generate a time-out signal
Mov  al,0f7h
Out  dx,al           ;Write 1 to bit 5 of F7 register
Inc  dx
In   al,dx
Or   al,20h
Out  dx,al
;-----
Dec dx                ; Lock NCT6776F
Mov  al,0aah
Out  dx,al
```

# Appendix **B**

I/O Pin Assignments

## B.1 Parallel Port Connector (LPT1)

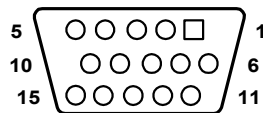


**Table B.1: Parallel port Connector (LPT1)**

Pin	Signal	Pin	Signal
1	STROBE*	2	AUTOFD*
3	D0	4	ERR
5	D1	6	INIT*
7	D2	8	SLCTINI*
9	D3	10	GND
11	D4	12	GND
13	D5	14	GND
15	D6	16	GND
17	D7	18	GND
19	ACK*	20	GND
21	BUSY	22	GND
23	PE	24	GND
25	SLCT	26	No pin

\* low active

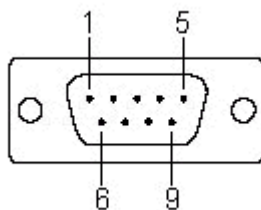
## B.2 VGA Connector (VGA1)



**Table B.2: VGA Connector (VGA1)**

Pin	Signal	Pin	Signal
1	RED	9	VCC
2	GREEN	10	GND
3	BLUE	11	N/C
4	N/C	12	SDT
5	GND	13	H-SYNC
6	GND	14	V-SYNC
7	GND	15	SCK
8	GND		

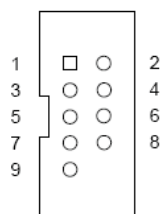
### B.3 RS-232 Seral Port (COMD1)



**Table B.3: COM Connector (COMD1)**

Pin	Signal
1	DCD
2	SIN
3	SOUT
4	DTR
5	GND
6	DSR
7	RTS
8	CTS
9	RI

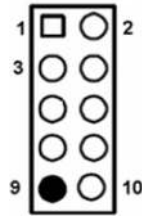
### B.4 RS-232 Serial Port (COM2)



**Table B.4: RS-232 Serial Port (COM2)**

Pin	Signal
1	DCD
2	DSR
3	SIN
4	RTS
5	SOUT
6	CTS
7	DTR
8	RI
9	GND

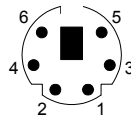
## B.5 USB 2.0 Header (USB12 & USB34)



**Table B.5: USB Header (USB12 & USB34)**

Pin	Signal	Pin	Signal
1	USB1_VCC5	6	USB2_D+
2	USB2_VCC5	7	GND
3	USB1_D-	8	GND
4	USB2_D-	9	No pin
5	USB1_D+	10	N/A

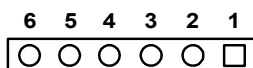
## B.6 PS/2 Keyboard/Mouse Connector (KBMS1)



**Table B.6: PS/2 Keyboard/Mouse Connector (KBMS1)**

Pin	Signal
1	KB DATA
2	MS DATA
3	GND
4	VCC
5	KB CLOCK
6	MS CLOCK

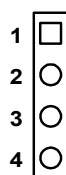
## B.7 External Keyboard Connector (KBMS2)



**Table B.7: External Keyboard Connector (KBMS2)**

Pin	Signal
1	KBCLK
2	KBDAT
3	MSDAT
4	GND
5	MSVCC
6	MSCLK

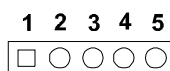
## B.8 CPU Fan Power Connector (CPUFAN1)



**Table B.8: CPU Fan Power Connector (CPUFAN1)**

Pin	Signal
1	GND
2	+12V
3	Detect
4	NC

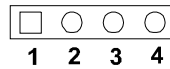
## B.9 Power LED and Keyboard Lock Connector (JFP3 / PWR\_LED & KEY LOCK)



**Table B.9: Power LED and Keyboard Lock Connector (JFP3 / PWR\_LED & KEY LOCK)**

Pin	Signal
1	LED power (+3.3 V)
2	NC
3	GND
4	KEYLOCK#
5	GND

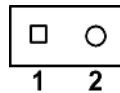
## B.10 External Speaker Connector (JFP2 / SPEAKER)



**Table B.10: External Speaker Connector (JFP2 / SPEAKER)**

Pin	Signal
1	SPK_CN17P1
2	SPK_CN17P2
3	SPK_CN17P3
4	SPK_CN17P4

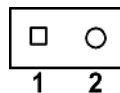
## B.11 Reset Connector (JFP1 / RESET)



**Table B.11: Reset Connector (JFP1 / RESET)**

Pin	Signal
1	RESET #
2	GND

## B.12 HDD LED (JFP2 / HDDLED)

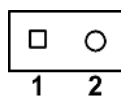


**Table B.12: HDD LED (JFP2 / HDDLED)**

Pin	Signal
1	HDD LED
2	SATA LED



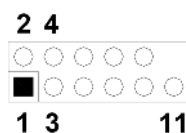
## B.13 ATX Soft Power Switch (JFP1 / PWR\_SW)



**Table B.13: ATX Soft Power Switch (JFP1 / PWR\_SW)**

Pin	Signal
1	3.3V_SB
2	PWR-BTN

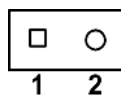
## B.14 Hi-definition Audio Link Connector (HDAUD1)



**Table B.14: Hi-Definition Audio Link Connector (HDAUD1)**

Pin	Signal	Pin	Signal
1	ACZ_VCC	2	GND
3	ACZ_SYNC	4	ACZ_BITCLK
5	ACZ_SDOUT	6	ACZ_SDIN0
7	ACZ_SDIN1	8	ACZ_RST
9	ACZ_12V	10	GND
11	GND	12	N/A

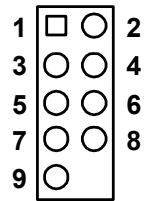
## B.15 SM Bus Connector (JFP2 / SNMP)



**Table B.15: SM Bus Connector (JFP2 / SNMP)**

Pin	Signal
1	SMB_DATA
2	SMB_CLK

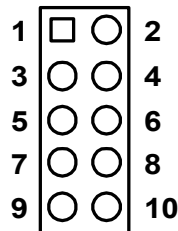
## B.16 LAN1 LED Connector (LANLED1)



**Table B.16: LAN1 LED Connector (LANLED1)**

Pin	Signal
1	#LAN1_ACT
2	N/A
3	V33_AUX
4	N/A
5	#LAN1_LINK1000
6	N/A
7	#LAN1_LINK100
8	N/A
9	V33_AUX

## B.17 GPIO Header (GPIO1)



**Table B.17: GPIO Header (GPIO1)**

Pin	Signal
1	SIO_GPIO0
2	SIO_GPIO4
3	SIO_GPIO1
4	SIO_GPIO5
5	SIO_GPIO2
6	SIO_GPIO6
7	SIO_GPIO3
8	SIO_GPIO7
9	VCC_GPIO
10	GND

## B.18 Fixed I/O Ranges Decoded by Intel PCH

Table B.18: Fixed I/O Ranges Decoded by PCH			
I/O Address	Read Target	Write Target	Internal Unit
00h-08h	DMA Controller	DMA Controller	DMA
09h-0Eh	RESERVED	DMA Controller	DMA
0Fh	DMA Controller	DMA Controller	DMA
10h-18h	DMA Controller	DMA Controller	DMA
19h-1Eh	RESERVED	DMA Controller	DMA
1Fh	DMA Controller	DMA Controller	DMA
20h-21h	Interrupt Controller	Interrupt Controller	Interrupt
24h-25h	Interrupt Controller	Interrupt Controller	Interrupt
28h-29h	Interrupt Controller	Interrupt Controller	Interrupt
2Ch-2Dh	Interrupt Controller	Interrupt Controller	Interrupt
2Eh-2Fh	LPC SIO	LPC SIO	Forwarded to LPC
30h-31h	Interrupt Controller	Interrupt Controller	Interrupt
34h-35h	Interrupt Controller	Interrupt Controller	Interrupt
38h-39h	Interrupt Controller	Interrupt Controller	Interrupt
3Ch-3Dh	Interrupt Controller	Interrupt Controller	Interrupt
40h-42h	Timer/Counter	Timer/Counter	PIT (8254)
43h	RESERVED	Timer/Counter	PIT
4Eh-4Fh	LPC SIO	LPC SIO	Forwarded to LPC
50h-52h	Timer/Counter	Timer/Counter	PIT
53h	RESERVED	Timer/Counter	PIT
60h	Microcontroller	Microcontroller	Forwarded to LPC
61h	NMI Controller	NMI Controller	Processor I/F
62h	Microcontroller	Microcontroller	Forwarded to LPC
64h	Microcontroller	Microcontroller	Forwarded to LPC
66h	Microcontroller	Microcontroller	Forwarded to LPC
70h	RESERVED	NMI and RTC Controller	RTC
71h	RTC Controller	RTC Controller	RTC
72h	RTC Controller	NMI and RTC Controller	RTC
73h	RTC Controller	RTC Controller	RTC
74h	RTC Controller	NMI and RTC Controller	RTC
75h	RTC Controller	RTC Controller	RTC
76h	RTC Controller	NMI and RTC Controller	RTC
77h	RTC Controller	RTC Controller	RTC
80h	DMA Controller, LPC, PCI, or PCIe	DMA Controller, LPC, PCI, or PCIe	DMA
81h-83h	DMA Controller	DMA Controller	DMA
84h-86h	DMA Controller	DMA Controller and LPC, PCI, or PCIe	DMA
87h	DMA Controller	DMA Controller	DMA

88h	DMA Controller	DMA Controller and LPC, PCI, or PCIe	DMA
89h–8Bh	DMA Controller	DMA Controller	DMA
8Ch–8Eh	DMA Controller	DMA Controller and LPC, PCI, or PCIe	DMA
8Fh	DMA Controller	DMA Controller	DMA
90h–91h	DMA Controller	DMA Controller	DMA
92h	Reset Generator	Reset Generator	Processor I/F
93h–9Fh	DMA Controller	DMA Controller	DMA
A0h–A1h	Interrupt Controller	Interrupt Controller	Interrupt
A4h–A5h	Interrupt Controller	Interrupt Controller	Interrupt
A8h–A9h	Interrupt Controller	Interrupt Controller	Interrupt
ACh–Adh	Interrupt Controller	Interrupt Controller	Interrupt
B0h–B1h	Interrupt Controller	Interrupt Controller	Interrupt
B2h–B3h	Power Management	Power Management	Power Management
B4h–B5h	Interrupt Controller	Interrupt Controller	Interrupt
B8h–B9h	Interrupt Controller	Interrupt Controller	Interrupt
BCh–BDh	Interrupt Controller	Interrupt Controller	Interrupt
C0h–D1h	DMA Controller	DMA Controller	DMA
D2h–DDh	RESERVED	DMA Controller	DMA
DEh–DFh	DMA Controller	DMA Controller	DMA
F0h	FERR# / Interrupt Controller	FERR# / Interrupt Controller	Processor I/F
170h–177h	SATA Controller, PCI, or PCIe	SATA Controller, PCI, or PCIe	SATA
1F0h–1F7h	SATA Controller, PCI, or PCIe	SATA Controller, PCI, or PCIe	SATA
200h–207h	Gameport Low	Gameport Low	Forwarded to LPC
208h–20Fh	Gameport High	Gameport High	Forwarded to LPC
376h	SATA Controller, PCI, or PCIe	SATA Controller, PCI, or PCIe	SATA
3F6h	SATA Controller, PCI, or PCIe	SATA Controller, PCI, or PCIe	SATA
4D0h–4D1h	Interrupt Controller	Interrupt Controller	Interrupt
CF9h	Reset Generator	Reset Generator	Processor I/F

## B.19 System I/O Ports

**Table B.19: System I/O Ports**

I/O Address(Hex)	Device
290h-29Fh	H/W Monitor
2F8h-2FFh	Communication Port (COM2)
378h-37Fh	ECP Printer Port(LPT1)
3B0h-3BBh	Graphics
3C0h-3DFh	Graphics
3F8h-3FFh	Communication Port (COM1)
400h-47Fh	PMBASE
500h-57Fh	GPIOBASE
600h-67Fh	PCA-COM485 Module I/O used
778h-77Fh	ECP Printer Port(LPT1)
C80h-C9Fh	Communication port (COM3-6) for PCA-COM232 module
CA0h-CBFh	Communication port (COM8-11) for PCA-COM485 module

## B.20 Interrupt Assignments

**Table B.20: Interrupt Assignments**

Interrupt#	Interrupt source
NMI	Parity error detected
IRQ0	System timer
IRQ1	Standard 101/102-key or Microsoft Natural PS/2 keyboard
IRQ2	Interrupt from controller 2 (cascade)
IRQ3	Communication port (COM2)
IRQ4	Communication port (COM1)
IRQ5	Available
IRQ6	Available
IRQ7	LPT1
IRQ8	System COMS/Real-time clock
IRQ9	SCI IRQ
IRQ10	Communication port (COM3-6) for PCA-COM232 module
IRQ11	Communication port (COM8-11) for PCA-COM485 module
IRQ12	PS/2 mouse
IRQ13	Numeric data processor
IRQ14	Available
IRQ15	Available

## B.21 1 MB Memory Map

**Table B.21: 1 MB Memory Map**

Address Range	Device
E8000h - FFFFFh	BIOS
D0000h - E7FFFh	Unused
C0000h - CFFFFh	VGA BIOS
A0000h - BFFFFh	Video Memory
00000h - 9FFFFh	Base memory

## B.22 PCI Bus Map

**Table B.22: PCI Bus Map**

Signal	IDSEL	INT#PIN	GNT	REQ
PCI Slot 1	AD31	INT B, C, D, A	GNT A	REQ A
PCI Slot 2	AD30	INT C, D, A, B	GNT B	REQ B
PCI Slot 3	AD29	INT D, A, B, C	GNT C	REQ C
PCI Slot 4	AD28	INT A, B, C, D	GNT D	REQ D

# Appendix **C**

Programming the  
GPIO

## C.1 Supported GPIO Register

Below are the detailed descriptions of the GPIO addresses and programming sample.

## C.2 GPIO Registers

Bank	Offset	Description
09h	30h	Write 1 to bit 7 to enable GPIO
07h	E0h	GPIO I/O Register When set to a '1', respective GPIO port is programmed as an input port. When set to a '0', respective GPIO port is programmed as an output port.
07h	E1h	GPIO Data Redister If a port is programmed to be an output port, then its respective bit can be read/written. If a port is programmed to be an input port, then its respective bit can only be read.
07h	E2h	GPIO Inversion Register When set to a '1', the incoming/outgoing port value is inverted. When set to a '0', the incoming/outgoing port value is the same as in data register.

## C.3 GPIO Example Program-1

```
-----  
Enter the extended function mode, interruptible double-write  
-----  
MOV DX, 2EH  
MOV AL, 87H  
OUT DX, AL  
OUT DX, AL  
-----  
-  
Configure logical device, configuration register  
CRE0, CRE1, CRE2  
-----  
-  
MOV DX, 2EH  
MOV AL, 09H  
OUT DX, AC  
DEC DX  
MOV AL, 30H  
OUT DX, AL  
INC DX  
IN AL, DX  
OR AL, 1000000B
```



```
DEC DX
MOV AL,07H
OUT DX,AL
INC DX
MOV AL,07H ; Select logical device 7
OUT DX,AL ;
DEC DX
MOV AL,E0H
OUT DX,AL
INC DX
MOV AL,00H ; 1:Input 0:output for GPIO respective
OUT DX,AL
DEC DX
MOV AL,E2H ;
OUT DX,AL
INC DX
MOV AL,00H ;Set GPIO is normal not inverter
OUT DX,AL;
DEC DX
MOV AL,E1H
OUT DX,AL
INC DX
MOV AL,??H ; Put the output value into AL
OUT DX,AL
-----
Exit extended function mode |
-----
MOV DX,2EH
MOV AL,AAH
OUT DX,AL
```

**ADVANTECH**

*Enabling an Intelligent Planet*

**[www.advantech.com](http://www.advantech.com)**

Please verify specifications before quoting. This guide is intended for reference purposes only.

All product specifications are subject to change without notice.

No part of this publication may be reproduced in any form or by any means, electronic, photocopying, recording or otherwise, without prior written permission of the publisher.

All brand and product names are trademarks or registered trademarks of their respective companies.

© Advantech Co., Ltd. 2012