

## Features

- ESD protection for 1 line with uni-directional
- Provide transient protection for each line to  
**IEC 61000-4-2 (ESD)  $\pm 30\text{kV}$  (air / contact)**  
**IEC 61000-4-4 (EFT)  $\pm 80\text{A}$  (5/50ns)**  
**IEC 61000-4-5 (Lightning) 20A (8/20 $\mu\text{s}$ )**
- Suitable for, **6V and below**, operating voltage applications
- **0201 small MCSP package** saves board space
- Protect one I/O line or one power line
- Fast turn-on and low clamping voltage
- Solid-state silicon-avalanche and active circuit triggering technology
- **Green part**

## Applications

- Power supply protection
- OLED
- Small panel modules
- Handheld portable applications
- Low speed data or control line protection
- Peripherals
- Consumer electronics

## Description

AZ5A16-01M is a design which includes a uni-directional surge rated clamping cell to protect one power line, or one control line, or one low speed data line in an electronic system. The AZ5A16-01M has been specifically designed to protect sensitive components which are connected to power and control lines from

over-voltage damage caused by Electrostatic Discharging (ESD), Electrical Fast Transients (EFT), Lightning, and Cable Discharge Event (CDE).

AZ5A16-01M is a unique design which includes proprietary clamping cell in a single package. During transient conditions, the proprietary clamping cell prevents over-voltage on the power line or control/data lines, protecting any downstream components.

AZ5A16-01M may be used to meet the ESD immunity requirements of IEC 61000-4-2, Level 4 ( $\pm 15\text{kV}$  air,  $\pm 8\text{kV}$  contact discharge).

## Circuit Diagram / Pin Configuration

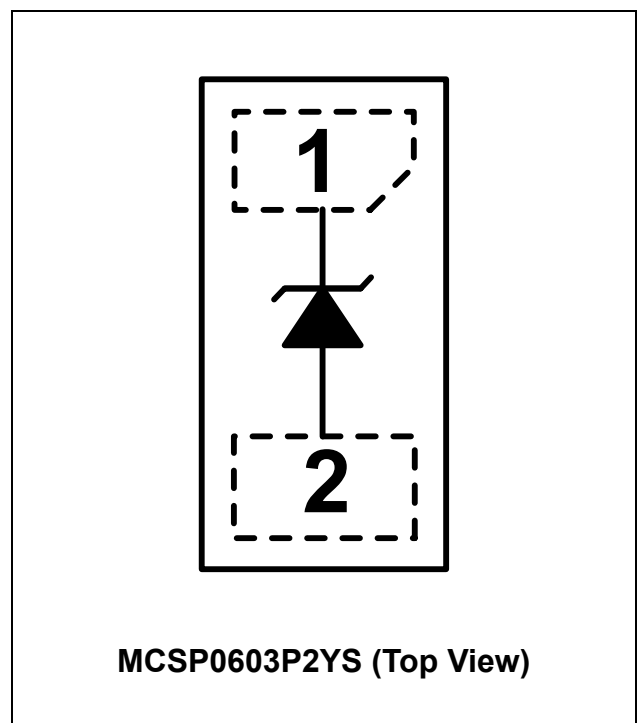

## Specifications

Absolute Maximum Ratings ( $T_A = 25^\circ\text{C}$ , unless otherwise specified)			
Parameter	Symbol	Rating	Unit
Peak Pulse Current ( $t_p = 8/20\mu\text{s}$ )	$I_{PP}$	20	A
Operating Voltage	$V_{DC}$	6.6	V
ESD per IEC 61000-4-2 (Air)	$V_{ESD-1}$	$\pm 30$	kV
ESD per IEC 61000-4-2 (Contact)	$V_{ESD-2}$	$\pm 30$	
Lead Soldering Temperature	$T_{SOL}$	260 (10 sec.)	$^\circ\text{C}$
Operating Temperature	$T_{OP}$	-55 to +125	$^\circ\text{C}$
Storage Temperature	$T_{STO}$	-55 to +150	$^\circ\text{C}$

Electrical Characteristics						
Parameter	Symbol	Condition	Min	Typ	Max	Unit
Reverse Stand-Off Voltage	$V_{RWM}$	Pin-1 to pin-2, $T = 25^\circ\text{C}$ .			6	V
Reverse Leakage Current	$I_{Leak}$	$V_{RWM} = 6\text{V}$ , $T = 25^\circ\text{C}$ , pin-1 to pin-2.			0.1	$\mu\text{A}$
Reverse Breakdown Voltage	$V_{BV}$	$I_{BV} = 1\text{mA}$ , $T = 25^\circ\text{C}$ , pin-1 to pin-2.	7	7.8	8.7	V
Forward Voltage	$V_F$	$I_F = 15\text{mA}$ , $T = 25^\circ\text{C}$ , pin-2 to pin-1.	0.5		1	V
Surge Clamping Voltage	$V_{CL-surge}$	$I_{PP} = 5\text{A}$ , $t_p = 8/20\mu\text{s}$ , $T = 25^\circ\text{C}$ .		8.5	9.2	V
		$I_{PP} = 20\text{A}$ , $t_p = 8/20\mu\text{s}$ , $T = 25^\circ\text{C}$ .		11	12	
ESD Clamping Voltage (Note 1)	$V_{clamp}$	IEC 61000-4-2 +8kV ( $I_{TLP} = 16\text{A}$ ), contact mode, $T = 25^\circ\text{C}$ , pin-1 to pin-2.		9		V
ESD Dynamic Turn-on Resistance	$R_{dynamic}$	IEC 61000-4-2 0~+8kV, $T = 25^\circ\text{C}$ , contact mode, pin-1 to pin-2.		0.08		$\Omega$
Channel Input Capacitance	$C_{IN}$	$V_R = 0\text{V}$ , $f = 1\text{MHz}$ , pin-1 to pin-2, $T = 25^\circ\text{C}$ .		110	140	pF

Note 1: ESD Clamping Voltage was measured by Transmission Line Pulsing (TLP) System.

TLP conditions:  $Z_0 = 50\Omega$ ,  $t_p = 100\text{ns}$ ,  $t_r = 1\text{ns}$ .

## Typical Characteristics

Reverse Clamping Voltage vs. Peak Pulse Current

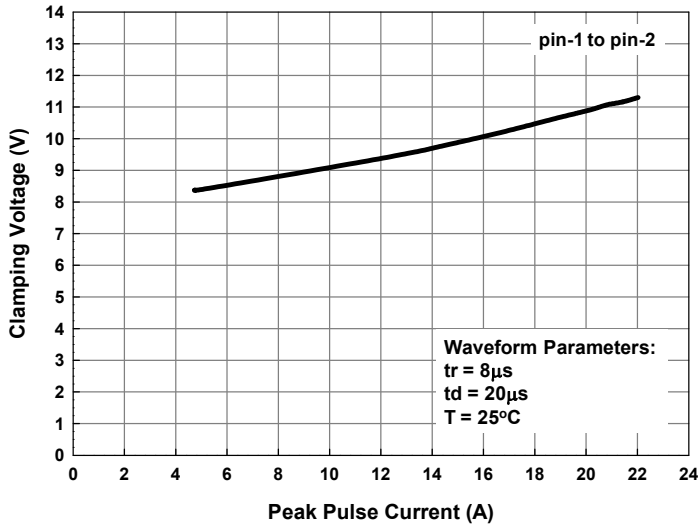

Forward Clamping Voltage vs. Peak Pulse Current

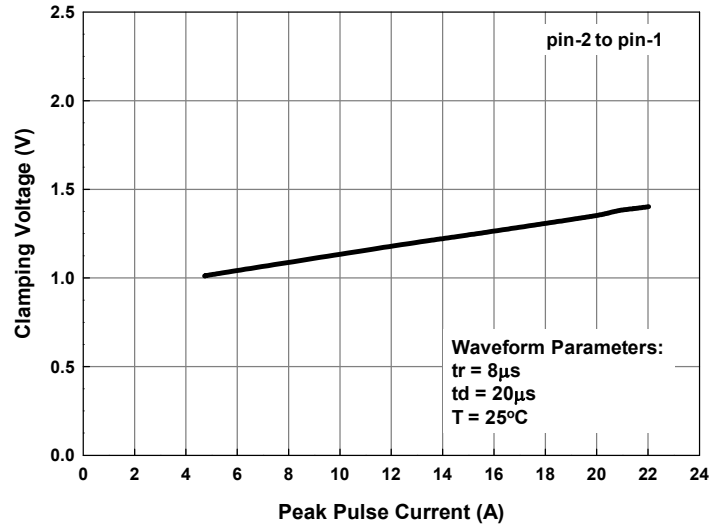

Transmission Line Pulsing (TLP) Measurement

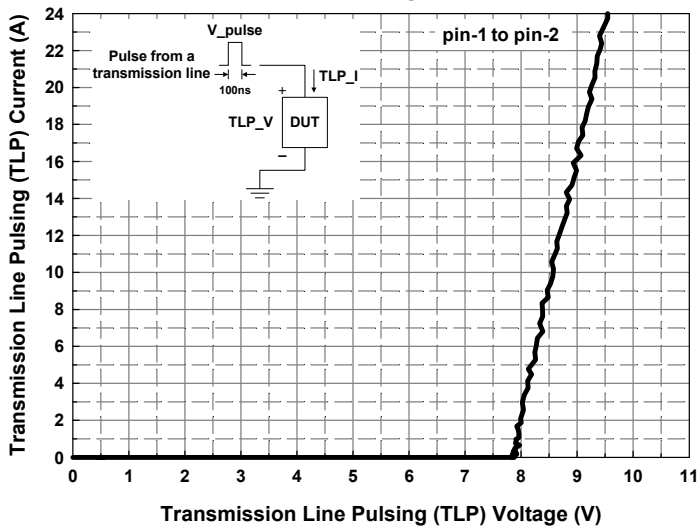

Typical Variation of  $C_{IN}$  vs.  $V_{IN}$

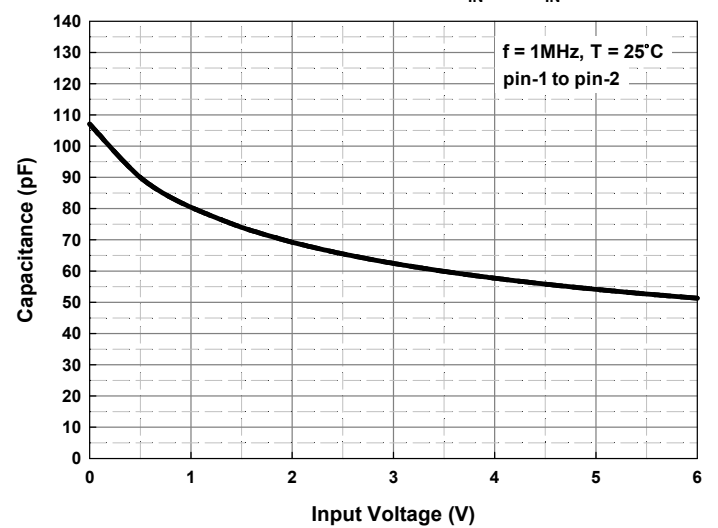

## Applications Information

The AZ5A16-01M is designed to protect one line against system ESD / EFT / Lightning pulses by clamping it to an acceptable reference.

The usage of the AZ5A16-01M is shown in Fig. 1. Protected lines, such as data lines, control lines, or power lines, are connected to pin 1. The pin 2 should be connected directly to a ground plane on the board. All path lengths connected to the pins of AZ5A16-01M should be kept as short as possible to minimize parasitic inductance in the board traces.

In order to obtain enough suppression of ESD induced transient, a good circuit board is critical.

Thus, the following guidelines are recommended:

- Minimize the path length between the protected lines and the AZ5A16-01M.
- Place the AZ5A16-01M near the input terminals or connectors to restrict transient coupling.
- The ESD current return path to ground should be kept as short as possible.
- Use ground planes whenever possible.
- NEVER route critical signals near board edges and near the lines which the ESD transient easily injects to.

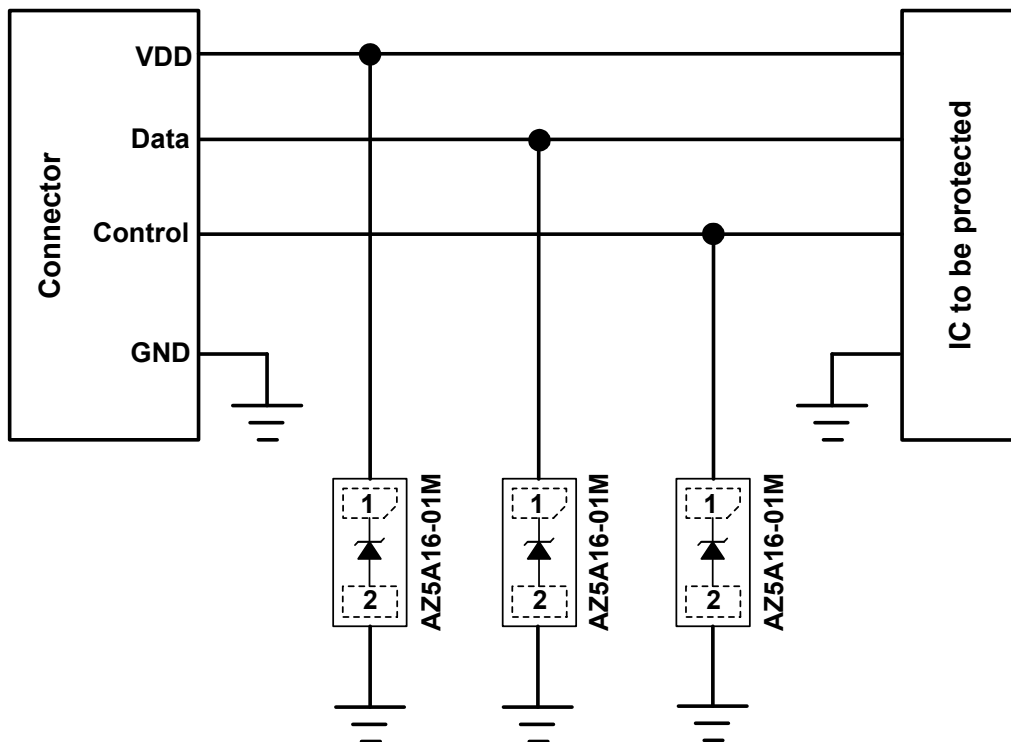
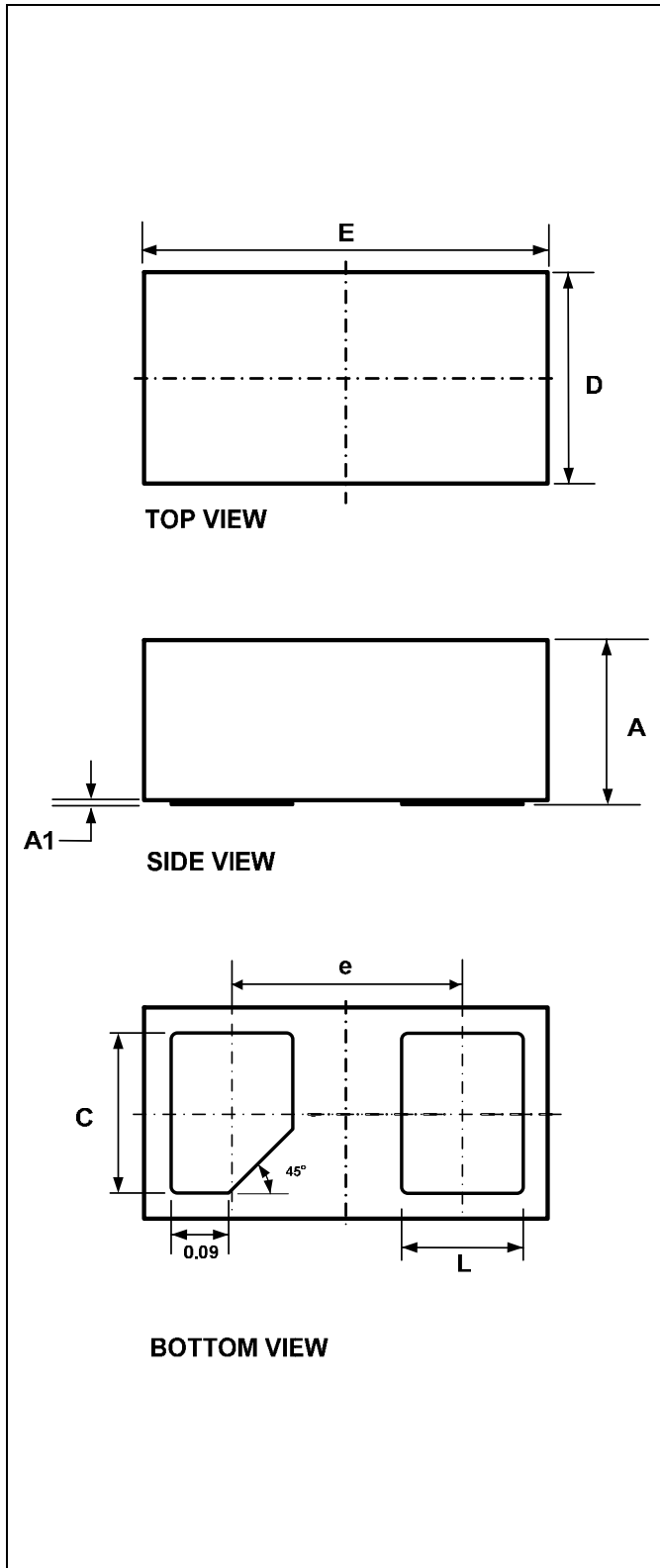

Fig. 1

## Mechanical Details

### MCSP0603P2YS Package Diagrams



### Package Dimensions

SYMBOL	MILLIMETERS		
	MIN.	NOM.	MAX.
E	0.615	0.630	0.645
D	0.315	0.330	0.345
A	0.235	0.250	0.265
A1	0.005	0.015	0.050
L	0.170	0.190	0.210
C	0.230	0.250	0.270
e	0.360 BSC		

### Land Layout

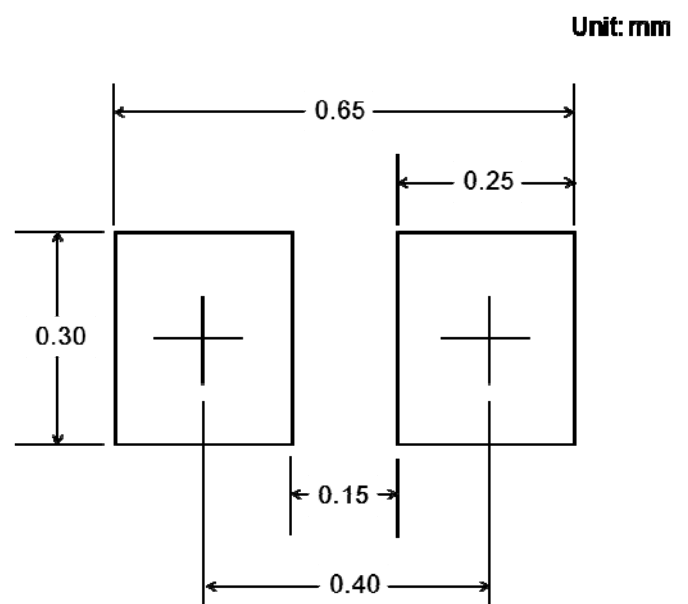

#### Notes:

This LAND LAYOUT is for reference purposes only. Please consult your manufacturing partners to ensure your company's PCB design guidelines are met.

### Marking Code

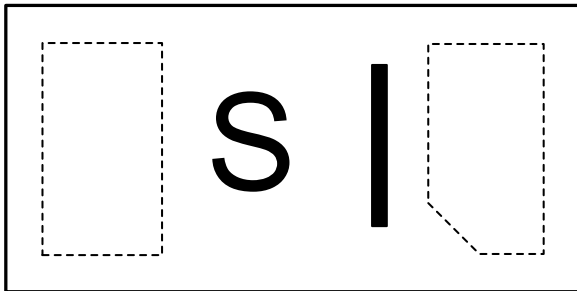

S= Device Code

Part Number	Marking Code
AZ5A16-01M.R7G (Green Part)	S

Note : Green means Pb-free, RoHS, and Halogen free compliant.

### Ordering Information

PN#	Material	Type	Reel size	MOQ	MOQ/internal box	MOQ/carton
AZ5A16-01M.R7G	Green	T/R	7 inch	15,000/reel	4 reels = 60,000/box	6 boxes = 360,000/carton

### Revision History

Revision	Modification Description
Revision 2022/01/27	Formal Release.