



# Bridgelux® Vero® SE 13 Array

Product Data Sheet DS121



# Introduction

Vero SE



Vero® SE Series is a revolutionary light source system that integrates Bridgelux's seventh generation COB technology with poke-in connectivity enabling solder-free installation. Vero SE LED light sources streamline assembly processes, lower manufacturing cost, simplify luminaire design, improve light quality and increase design flexibility.

Vero SE is available in four different light emitting surface (LES) configurations that operate reliably over a broad current range. With Vero SE, secondary connector and holder components are not required, allowing for rapid integration of arrays into fixtures and an efficient field replaceable solution. Vero SE arrays deliver increased lumen density for improved beam control and precision lighting with 2 and 3 SDCM color control standards for clean and consistent uniform lighting.

Bridgelux Décor Series is our state of the art color line designed specifically for premium applications, producing unmatched LED light quality with brilliant color-rendering options and offer pleasing and inspiring lighting palettes. Bridgelux Décor Series color points are available on Vero® SE Series, Vero® Series, V Series™ and V Series™ HD.

**Décor Series Class A** is based on human response testing, providing color points with a combined GAI and CRI metric.

**Décor Series™ Ultra** products provide a high CRI of 97 and a minimum R<sub>g</sub> value of 93, which emphasizes the reds and color tones to which the human eye is most receptive - perfect for the most luxurious retail shops and world renowned museums. Décor Series Ultra is also a good replacement for halogen lamps.

**Décor Series™ Showcase** is the optimal solution for replacing ceramic metal halide lamps, incorporating the same pure white light with enhanced spectrum coverage and higher efficacy.

## Features

- Poke-in connectivity
- Efficacy of 157 lm/W typical
- Lumen output performance ranges from 511 to 6,931 lumens
- Broad range of CCT options from 2700K to 6500K
- CRI options: minimum 70, 80, and 90
- Color control: 2 and 3 SDCM for 2700K-4000K CCT
- Reliable operation at up to 2X nominal drive current
- Radial die pattern and improved lumen density
- Top side part number markings
- No exposed solder pads or electrical connections
- V<sub>f</sub> bin code backside marking

## Benefits

- Poke-in connectivity enables solderless, connector free installation
- Broad application coverage for interior and exterior lighting
- Flexibility for application driven lighting design requirements
- High quality, true color reproduction
- Uniform consistent white light
- Flexibility in design optimization
- Enhanced ease of use and assembly
- Ability to configure multiple Vero SE arrays in series and parallel reduces customer driver cost
- Improved inventory management and quality control

# Contents

Product Feature Map	2
Product Nomenclature	2
Product Selection Guide	3
Performance at Commonly Used Drive Currents	10
Electrical Characteristics	19
Eye Safety	20
Absolute Maximum Ratings	21
Performance Curves	22
Typical Radiation Pattern	25
Typical Color Spectrum	26
Mechanical Dimensions	27
Color Binning Information	28
Packaging and Labeling	29
Design Resources	31
Precautions	31
Disclaimers	31
About Bridgelux	32



# Product Selection Guide

The following product configurations are available:

**Table 1:** Selection Guide, Pulsed Measurement Data ( $T_j = T_c = 25^\circ\text{C}$ )

Part Number	Nominal CCT <sup>1</sup> (K)	CRI <sup>2</sup>	Nominal Drive Current <sup>3</sup> (mA)	Typical Pulsed Flux <sup>4,5,6</sup> $T_c = 25^\circ\text{C}$ (lm)	Minimum Pulsed Flux <sup>6,7</sup> $T_c = 25^\circ\text{C}$ (lm)	Typical $V_f$ (V)	Typical Power (W)	Typical Efficacy (lm/W)
BXRC-27E2000-B-7X-SE	2700	80	450	2365	2128	34.8	15.7	151
BXRC-27E2000-C-7X-SE	2700	80	630	3311	2979	34.8	21.9	151
BXRC-27E2000-D-7X-SE	2700	80	500	2401	2161	31.8	15.9	151
BXRC-27G20H0-B-7X-SE	2700	90	450	2036	1832	34.8	15.7	130
BXRC-27G20H0-C-7X-SE	2700	90	630	2850	2565	34.8	21.9	130
BXRC-27G20H0-D-7X-SE	2700	90	500	2067	1860	31.8	15.9	130
BXRC-27G2000-B-7X-SE	2700	90	450	1973	1776	34.8	15.7	126
BXRC-27G2000-C-7X-SE	2700	90	630	2762	2486	34.8	21.9	126
BXRC-27G2000-D-7X-SE	2700	90	500	2003	1803	31.8	15.9	126
BXRC-27H2000-B-7X-SE	2700	97	450	1707	1536	34.8	15.7	109
BXRC-27H2000-C-7X-SE	2700	97	630	2390	2151	34.8	21.9	109
BXRC-27H2000-D-7X-SE	2700	97	500	1733	1560	31.8	15.9	109
BXRC-30C2001-B-7X-SE	3000	70	450	2694	2424	34.8	15.7	172
BXRC-30C2001-C-7X-SE	3000	70	630	3771	3394	34.8	21.9	172
BXRC-30C2001-D-7X-SE	3000	70	500	2735	2461	31.8	15.9	172
BXRC-30E2000-B-7X-SE	3000	80	450	2459	2213	34.8	15.7	157
BXRC-30E2000-C-7X-SE	3000	80	630	3442	3098	34.8	21.9	157
BXRC-30E2000-D-7X-SE	3000	80	500	2496	2247	31.8	15.9	157
BXRC-30G20H0-B-7X-SE	3000	90	450	2145	1931	34.8	15.7	137
BXRC-30G20H0-C-7X-SE	3000	90	630	3004	2703	34.8	21.9	137
BXRC-30G20H0-D-7X-SE	3000	90	500	2178	1960	31.8	15.9	137
BXRC-30G2000-B-7X-SE	3000	90	450	2051	1846	34.8	15.7	131
BXRC-30G2000-C-7X-SE	3000	90	630	2872	2585	34.8	21.9	131
BXRC-30G2000-D-7X-SE	3000	90	500	2083	1875	31.8	15.9	131
BXRC-30G200C-B-73-SE	3000	90	450	1906		34.8	15.8	121
BXRC-30G200C-D-73-SE	3000	90	500	1924	1732	31.8	15.9	121
BXRC-30H2000-B-7X-SE	3000	97	450	1832	1649	34.8	15.7	117
BXRC-30H2000-C-7X-SE	3000	97	630	2565	2309	34.8	21.9	117
BXRC-30H2000-D-7X-SE	3000	97	500	1860	1674	31.8	15.9	117
BXRC-30A2001-B-73-SE <sup>8,9</sup>	3000	93	450	1848	1663	34.8	15.7	118
BXRC-30A2001-C-73-SE <sup>8,9</sup>	3000	93	630	2587	2328	34.8	21.9	118
BXRC-30A2001-D-73-SE <sup>8,9</sup>	3000	93	500	1876	1689	31.8	15.9	118

Notes for Table 1:

- Nominal CCT as defined by ANSI C78.377-2011. Products with a CCT of 5000K-6500K are hot targeted to  $T_c = 85^\circ\text{C}$ .
- CRI values are typical for Decor Series Ultra, Decor Series Street and Landmark and Decor Series Class A products. CRI values are minimums for all other products. Minimum Rg value for 80 CRI products is 0, the minimum Rg value for 90 CRI products is 50, the minimum Rg value for 97 CRI products is 93. Bridgelux maintains a  $\pm 3$  tolerance on CRI and Rg values.
- Drive current is referred to as nominal drive current.
- Products tested under pulsed condition (10ms pulse width) at nominal test current where  $T_j$  (junction temperature) -  $T_c$  (case temperature) =  $25^\circ\text{C}$ .
- Typical performance values are provided as a reference only and are not a guarantee of performance.
- Bridgelux maintains a  $\pm 7\%$  tolerance on flux measurements.
- Minimum flux values at the nominal test current are guaranteed by 100% test.
- Nominal CCT is defined by the Lighting Research Center's Class A definition. The center of the Class A color bin is on the corresponding isothermal line.
- GAI value is 80. To help ensure optimal fixture level performance, GAI is measured at the fixture level, on axis, at a case temperature of  $70^\circ\text{C}$ . GAI may vary depending on fixture design and performance.

# Product Selection Guide

**Table 1:** Selection Guide, Pulsed Measurement Data ( $T_j = T_c = 25^\circ\text{C}$ ) (continued)

Part Number	Nominal CCT <sup>1</sup> (K)	CRI <sup>2</sup>	Nominal Drive Current <sup>3</sup> (mA)	Typical Pulsed Flux <sup>4,5,6</sup> $T_c = 25^\circ\text{C}$ (lm)	Minimum Pulsed Flux <sup>6,7</sup> $T_c = 25^\circ\text{C}$ (lm)	Typical $V_f$ (V)	Typical Power (W)	Typical Efficacy (lm/W)
BXRC-35E2000-B-7X-SE	3500	80	450	2537	2283	34.8	15.7	162
BXRC-35E2000-C-7X-SE	3500	80	630	3552	3197	34.8	21.9	162
BXRC-35E2000-D-7X-SE	3500	80	500	2576	2318	31.8	15.9	162
BXRC-35G2000-B-7X-SE	3500	90	450	2114	1903	34.8	15.7	135
BXRC-35G2000-C-7X-SE	3500	90	630	2960	2664	34.8	21.9	135
BXRC-35G2000-D-7X-SE	3500	90	500	2147	1932	31.8	15.9	135
BXRC-35A2001-B-73-SE <sup>8,9</sup>	3500	93	450	1989	1790	34.8	15.7	127
BXRC-35A2001-C-73-SE <sup>8,9</sup>	3500	93	630	2784	2506	34.8	21.9	127
BXRC-35A2001-D-73-SE <sup>8,9</sup>	3500	93	500	2019	1817	31.8	15.9	127
BXRC-40C2001-B-7X-SE	4000	70	450	2772	2495	34.8	15.7	177
BXRC-40C2001-C-7X-SE	4000	70	630	3881	3492	34.8	21.9	177
BXRC-40C2001-D-7X-SE	4000	70	500	2814	2533	31.8	15.9	177
BXRC-40E2000-B-7X-SE	4000	80	450	2553	2297	34.8	15.7	163
BXRC-40E2000-C-7X-SE	4000	80	630	3574	3216	34.8	21.9	163
BXRC-40E2000-D-7X-SE	4000	80	500	2592	2333	31.8	15.9	163
BXRC-40G2000-B-7X-SE	4000	90	450	2192	1973	34.8	15.7	140
BXRC-40G2000-C-7X-SE	4000	90	630	3069	2762	34.8	21.9	140
BXRC-40G2000-D-7X-SE	4000	90	500	2226	2003	31.8	15.9	140
BXRC-40H2000-B-7X-SE	4000	97	450	1864	1677	34.8	15.7	119
BXRC-40H2000-C-7X-SE	4000	97	630	2609	2348	34.8	21.9	119
BXRC-40H2000-D-7X-SE	4000	97	500	1892	1703	31.8	15.9	119
BXRC-40A2001-B-73-SE <sup>8,9</sup>	4000	93	450	2130	1917	34.8	15.7	136
BXRC-40A2001-C-73-SE <sup>8,9</sup>	4000	93	630	2982	2683	34.8	21.9	136
BXRC-40A2001-D-73-SE <sup>8,9</sup>	4000	93	500	2162	1946	31.8	15.9	136
BXRC-50C2001-B-74-SE	5000	70	450	2803	2523	34.8	15.7	179
BXRC-50C2001-C-74-SE	5000	70	630	3924	3532	34.8	21.9	179
BXRC-50C2001-D-74-SE	5000	70	500	2846	2561	31.8	15.9	179
BXRC-50E2001-B-74-SE	5000	80	450	2631	2368	34.8	15.7	168
BXRC-50E2001-C-74-SE	5000	80	630	3683	3315	34.8	21.9	168
BXRC-50E2001-D-74-SE	5000	80	500	2671	2404	31.8	15.9	168
BXRC-50G2001-B-74-SE	5000	90	450	2239	2015	34.8	15.7	143
BXRC-50G2001-C-74-SE	5000	90	630	3135	2822	34.8	21.9	143
BXRC-50G2001-D-74-SE	5000	90	500	2274	2046	31.8	15.9	143

Notes for Table 1:

- Nominal CCT as defined by ANSI C78.377-2011. Products with a CCT of 5000K-6500K are hot targeted to  $T_c = 85^\circ\text{C}$ .
- CRI values are typical for Decor Series Ultra, Decor Series Street and Landmark and Decor Series Class A products. CRI values are minimums for all other products. Minimum Rg value for 80 CRI products is 0, the minimum Rg value for 90 CRI products is 50, the minimum Rg value for 97 CRI products is 93. Bridgelux maintains a  $\pm 3$  tolerance on CRI and Rg values.
- Drive current is referred to as nominal drive current.
- Products tested under pulsed condition (10ms pulse width) at nominal test current where  $T_j$  (junction temperature) -  $T_c$  (case temperature) =  $25^\circ\text{C}$ .
- Typical performance values are provided as a reference only and are not a guarantee of performance.
- Bridgelux maintains a  $\pm 7\%$  tolerance on flux measurements.
- Minimum flux values at the nominal test current are guaranteed by 100% test.
- Nominal CCT is defined by the Lighting Research Center's Class A definition. The center of the Class A color bin is on the corresponding isothermal line.
- GAI value is 80. To help ensure optimal fixture level performance, GAI is measured at the fixture level, on axis, at a case temperature of  $70^\circ\text{C}$ . GAI may vary depending on fixture design and performance.

# Product Selection Guide

**Table 1:** Selection Guide, Pulsed Measurement Data ( $T_j = T_c = 25^\circ\text{C}$ ) (continued)

Part Number	Nominal CCT <sup>1</sup> (K)	CRI <sup>2</sup>	Nominal Drive Current <sup>3</sup> (mA)	Typical Pulsed Flux <sup>4,5,6</sup> $T_c = 25^\circ\text{C}$ (lm)	Minimum Pulsed Flux <sup>6,7</sup> $T_c = 25^\circ\text{C}$ (lm)	Typical $V_f$ (V)	Typical Power (W)	Typical Efficacy (lm/W)
BXRC-57C2001-B-74-SE	5700	70	450	2709	2438	34.8	15.7	173
BXRC-57C2001-C-74-SE	5700	70	630	3793	3414	34.8	21.9	173
BXRC-57C2001-D-74-SE	5700	70	500	2751	2476	31.8	15.9	173
BXRC-57E2001-B-74-SE	5700	80	450	2600	2340	34.8	15.7	166
BXRC-57E2001-C-74-SE	5700	80	630	3639	3275	34.8	21.9	166
BXRC-57E2001-D-74-SE	5700	80	500	2639	2375	31.8	15.9	166
BXRC-65C2001-B-74-SE	6500	70	450	2756	2481	34.8	15.7	176
BXRC-65C2001-C-74-SE	6500	70	630	3859	3473	34.8	21.9	176
BXRC-65C2001-D-74-SE	6500	70	500	2798	2519	31.8	15.9	176
BXRC-65E2001-B-74-SE	6500	80	450	2647	2382	34.8	15.7	169
BXRC-65E2001-C-74-SE	6500	80	630	3705	3335	34.8	21.9	169
BXRC-65E2001-D-74-SE	6500	80	500	2687	2418	31.8	15.9	169

Notes for Table 1:

- Nominal CCT as defined by ANSI C78.377-2011. Products with a CCT of 5000K-6500K are hot targeted to  $T_c = 85^\circ\text{C}$ .
- CRI values are typical for Decor Series Ultra, Decor Series Street and Landmark and Decor Series Class A products. CRI values are minimums for all other products. Minimum Rg value for 80 CRI products is 0, the minimum Rg value for 90 CRI products is 50, the minimum Rg value for 97 CRI products is 93. Bridgelux maintains a  $\pm 3$  tolerance on CRI and Rg values.
- Drive current is referred to as nominal drive current.
- Products tested under pulsed condition (10ms pulse width) at nominal test current where  $T_j$  (junction temperature) -  $T_c$  (case temperature) =  $25^\circ\text{C}$ .
- Typical performance values are provided as a reference only and are not a guarantee of performance.
- Bridgelux maintains a  $\pm 7\%$  tolerance on flux measurements.
- Minimum flux values at the nominal test current are guaranteed by 100% test.
- Nominal CCT is defined by the Lighting Research Center's Class A definition. The center of the Class A color bin is on the corresponding isothermal line.
- GAI value is 80. To help ensure optimal fixture level performance, GAI is measured at the fixture level, on axis, at a case temperature of  $70^\circ\text{C}$ . GAI may vary depending on fixture design and performance.

# Product Selection Guide

**Table 2:** Selection Guide. Stabilized DC Performance ( $T_c = 70^\circ\text{C}$ ) <sup>7,8</sup>

Part Number	Nominal CCT <sup>1</sup> (K)	GAI <sup>2</sup>	CRI <sup>3</sup>	Nominal Drive Current <sup>4</sup> (mA)	Typical DC Flux <sup>5,6</sup> $T_c = 70^\circ\text{C}$ (lm)	Minimum DC Flux <sup>6,9</sup> $T_c = 70^\circ\text{C}$ (lm)	Typical $V_f$ (V)	Typical Power (W)	Typical Efficacy (lm/W)
BXRC-30A2001-B-73	3000	80	93	450	1719	1512	34.4	15.5	111
BXRC-30A2001-C-73	3000	80	93	630	2406	2117	34.4	21.6	111
BXRC-30A2001-D-73	3000	80	93	500	1745	1535	31.2	15.6	112
BXRC-35A2001-B-73	3500	80	93	450	1850	1628	34.4	15.5	120
BXRC-35A2001-C-73	3500	80	93	630	2589	2279	34.4	21.6	120
BXRC-35A2001-D-73	3500	80	93	500	1878	1653	31.2	15.6	120
BXRC-40A2001-B-73	4000	80	93	450	1981	1743	34.4	15.5	128
BXRC-40A2001-C-73	4000	80	93	630	2773	2440	34.4	21.6	128
BXRC-40A2001-D-73	4000	80	93	500	2011	1770	31.2	15.6	129

Notes for Table 2:

- Nominal CCT is defined by the Lighting Research Center's Class A definition. The center of the Class A color bin is on the corresponding isothermal line.
- To help ensure optimal fixture level performance, GAI is measured at the fixture level, on axis, at a case temperature of  $70^\circ\text{C}$ . GAI may vary depending on fixture design and performance.
- CRI Values are specified as typical.
- Drive current is referred to as nominal drive current.
- Typical performance values are provided as a reference only and are not a guarantee of performance.
- Bridgelux maintains a  $\pm 7\%$  tolerance on flux measurements.
- Typical stabilized DC performance values are provided as reference only and are not a guarantee of performance.
- Typical performance is estimated based on operation under DC (direct current) with LED array mounted onto a heat sink with thermal interface material and the case temperature maintained at specified temperature. Based on Bridgelux test setup, values may vary depending on the thermal design of the luminaire and/or the exposed environment to which the product is subjected.
- Minimum flux values at elevated temperatures are provided for reference only and are not guaranteed by 100% production testing. Based on Bridgelux test setup, values may vary depending on the thermal design of the luminaire and/or the exposed environment to which the product is subjected.



# Product Selection Guide

**Table 3:** Selection Guide, Stabilized DC Performance ( $T_c = 85^\circ\text{C}$ )<sup>4,5</sup>

Part Number	Nominal CCT <sup>1</sup> (K)	CRI <sup>2</sup>	Nominal Drive Current <sup>3</sup> (mA)	Typical DC Flux <sup>4,5</sup> $T_c = 85^\circ\text{C}$ (lm)	Minimum DC Flux <sup>6</sup> $T_c = 85^\circ\text{C}$ (lm)	Typical $V_f$ (V)	Typical Power (W)	Typical Efficacy (lm/W)
BXRC-27E2000-B-7X-SE	2700	80	450	2128	1915	33.9	15.3	139
BXRC-27E2000-C-7X-SE	2700	80	630	2979	2682	33.9	21.4	139
BXRC-27E2000-D-7X-SE	2700	80	500	2161	1945	30.9	15.5	140
BXRC-27G20H0-B-7X-SE	2700	90	450	1832	1649	33.9	15.3	120
BXRC-27G20H0-C-7X-SE	2700	90	630	2565	2309	33.9	21.4	120
BXRC-27G20H0-D-7X-SE	2700	90	500	1860	1674	30.9	15.5	120
BXRC-27G2000-B-7X-SE	2700	90	450	1776	1598	33.9	15.3	116
BXRC-27G2000-C-7X-SE	2700	90	630	2486	2238	33.9	21.4	116
BXRC-27G2000-D-7X-SE	2700	90	500	1803	1623	30.9	15.5	117
BXRC-27H2000-B-7X-SE	2700	97	450	1536	1383	33.9	15.3	101
BXRC-27H2000-C-7X-SE	2700	97	630	2151	1936	33.9	21.4	101
BXRC-27H2000-D-7X-SE	2700	97	500	1560	1404	30.9	15.5	101
BXRC-30C2001-B-7X-SE	3000	70	450	2424	2182	33.9	15.3	159
BXRC-30C2001-C-7X-SE	3000	70	630	3394	3054	33.9	21.4	159
BXRC-30C2001-D-7X-SE	3000	70	500	2461	2215	30.9	15.5	159
BXRC-30E2000-B-7X-SE	3000	80	450	2213	1991	33.9	15.3	145
BXRC-30E2000-C-7X-SE	3000	80	630	3098	2788	33.9	21.4	145
BXRC-30E2000-D-7X-SE	3000	80	500	2247	2022	30.9	15.5	145
BXRC-30G20H0-B-7X-SE	3000	90	450	1931	1738	33.9	15.3	127
BXRC-30G20H0-C-7X-SE	3000	90	630	2703	2433	33.9	21.4	127
BXRC-30G20H0-D-7X-SE	3000	90	500	1960	1764	30.9	15.5	127
BXRC-30G2000-B-7X-SE	3000	90	450	1846	1662	33.9	15.3	121
BXRC-30G2000-C-7X-SE	3000	90	630	2585	2326	33.9	21.4	121
BXRC-30G2000-D-7X-SE	3000	90	500	1875	1687	30.9	15.5	121
BXRC-30G200C-B-73-SE	3000	90	450	1715	1544	33.9	15.3	112
BXRC-30G200C-D-73-SE	3000	90	500	1732	1558	30.9	15.5	112
BXRC-30H2000-B-7X-SE	3000	97	450	1649	1484	33.9	15.3	108
BXRC-30H2000-C-7X-SE	3000	97	630	2309	2078	33.9	21.4	108
BXRC-30H2000-D-7X-SE	3000	97	500	1674	1507	30.9	15.5	108
BXRC-30A2001-B-73-SE <sup>7,8</sup>	3000	93	450	1663	1497	33.9	15.3	109
BXRC-30A2001-C-73-SE <sup>7,8</sup>	3000	93	630	2328	2095	33.9	21.4	109
BXRC-30A2001-D-73-SE <sup>7,8</sup>	3000	93	500	1689	1520	30.9	15.5	109

Notes for Table 3:

- Nominal CCT as defined by ANSI C78.377-2011. Products with a CCT of 5000K-6500K are hot targeted to  $T_c = 85^\circ\text{C}$ .
- All CRI values are measured at  $T_c = T_a = 25^\circ\text{C}$ . CRI values are typical for Decor Series Ultra, Decor Series Street and Landmark and Decor Series Class A products. CRI values are minimums for all other products. Minimum Rg value for 80 CRI products is 0, the minimum Rg value for 90 CRI products is 50, the minimum Rg value for 97 CRI products is 93. Bridgelux maintains a  $\pm 3$  tolerance on CRI and Rg values.
- Drive current is referred to as nominal drive current.
- Typical stabilized DC performance values are provided as reference only and are not a guarantee of performance.
- Typical performance is estimated based on operation under DC (direct current) with LED array mounted onto a heat sink with thermal interface material and the case temperature maintained at  $85^\circ\text{C}$ . Based on Bridgelux test setup, values may vary depending on the thermal design of the luminaire and/or the exposed environment to which the product is subjected.
- Minimum flux values at elevated temperatures are provided for reference only and are not guaranteed by 100% production testing. Based on Bridgelux test setup, values may vary depending on the thermal design of the luminaire and/or the exposed environment to which the product is subjected.
- Nominal CCT is defined by the Lighting Research Center's Class A definition. The center of the Class A color bin is on the corresponding isothermal line.
- GAI value is 80. To help ensure optimal fixture level performance, GAI is measured at the fixture level, on axis, at a case temperature of  $70^\circ\text{C}$ . GAI may vary depending on fixture design and performance.

# Product Selection Guide

**Table 3:** Selection Guide, Stabilized DC Performance ( $T_c = 85^\circ\text{C}$ )<sup>4,5</sup> (continued)

Part Number	Nominal CCT <sup>1</sup> (K)	CRI <sup>2</sup>	Nominal Drive Current <sup>3</sup> (mA)	Typical DC Flux <sup>4,5</sup> $T_c = 85^\circ\text{C}$ (lm)	Minimum DC Flux <sup>6</sup> $T_c = 85^\circ\text{C}$ (lm)	Typical $V_f$ (V)	Typical Power (W)	Typical Efficacy (lm/W)
BXRC-35E2000-B-7X-SE	3500	80	450	2283	2055	33.9	15.3	150
BXRC-35E2000-C-7X-SE	3500	80	630	3197	2877	33.9	21.4	150
BXRC-35E2000-D-7X-SE	3500	80	500	2318	2086	30.9	15.5	150
BXRC-35G2000-B-7X-SE	3500	90	450	1903	1712	33.9	15.3	125
BXRC-35G2000-C-7X-SE	3500	90	630	2664	2397	33.9	21.4	125
BXRC-35G2000-D-7X-SE	3500	90	500	1932	1739	30.9	15.5	125
BXRC-35A2001-B-73-SE <sup>7,8</sup>	3500	93	450	1790	1611	33.9	15.3	117
BXRC-35A2001-C-73-SE <sup>7,8</sup>	3500	93	630	2506	2255	33.9	21.4	117
BXRC-35A2001-D-73-SE <sup>7,8</sup>	3500	93	500	1817	1636	30.9	15.5	118
BXRC-40C2001-B-7X-SE	4000	70	450	2495	2245	33.9	15.3	164
BXRC-40C2001-C-7X-SE	4000	70	630	3492	3143	33.9	21.4	164
BXRC-40C2001-D-7X-SE	4000	70	500	2533	2280	30.9	15.5	164
BXRC-40E2000-B-7X-SE	4000	80	450	2297	2068	33.9	15.3	151
BXRC-40E2000-C-7X-SE	4000	80	630	3216	2895	33.9	21.4	151
BXRC-40E2000-D-7X-SE	4000	80	500	2333	2099	30.9	15.5	151
BXRC-40G2000-B-7X-SE	4000	90	450	1973	1776	33.9	15.3	129
BXRC-40G2000-C-7X-SE	4000	90	630	2762	2486	33.9	21.4	129
BXRC-40G2000-D-7X-SE	4000	90	500	2003	1803	30.9	15.5	130
BXRC-40H2000-B-7X-SE	4000	97	450	1677	1509	33.9	15.3	110
BXRC-40H2000-C-7X-SE	4000	97	630	2348	2113	33.9	21.4	110
BXRC-40H2000-D-7X-SE	4000	97	500	1703	1533	30.9	15.5	110
BXRC-40A2001-B-73-SE <sup>7,8</sup>	4000	93	450	1917	1725	33.9	15.3	126
BXRC-40A2001-C-73-SE <sup>7,8</sup>	4000	93	630	2683	2415	33.9	21.4	126
BXRC-40A2001-D-73-SE <sup>7,8</sup>	4000	93	500	1946	1752	30.9	15.5	126
BXRC-50C2001-B-74-SE	5000	70	450	2523	2271	33.9	15.3	165
BXRC-50C2001-C-74-SE	5000	70	630	3532	3179	33.9	21.4	165
BXRC-50C2001-D-74-SE	5000	70	500	2561	2305	30.9	15.5	166
BXRC-50E2001-B-74-SE	5000	80	450	2368	2131	33.9	15.3	155
BXRC-50E2001-C-74-SE	5000	80	630	3315	2983	33.9	21.4	155
BXRC-50E2001-D-74-SE	5000	80	500	2404	2164	30.9	15.5	155
BXRC-50G2001-B-74-SE	5000	90	450	2015	1814	33.9	15.3	132
BXRC-50G2001-C-74-SE	5000	90	630	2822	2539	33.9	21.4	132
BXRC-50G2001-D-74-SE	5000	90	500	2046	1842	30.9	15.5	132

Notes for Table 3:

- Nominal CCT as defined by ANSI C78.377-2011. Products with a CCT of 5000K-6500K are hot targeted to  $T_c = 85^\circ\text{C}$ .
- All CRI values are measured at  $T_c = 25^\circ\text{C}$ . CRI values are typical for Decor Series Ultra, Decor Series Street and Landmark and Decor Series Class A products. CRI values are minimums for all other products. Minimum Rg value for 80 CRI products is 0, the minimum Rg value for 90 CRI products is 50, the minimum Rg value for 97 CRI products is 93. Bridgelux maintains a  $\pm 3$  tolerance on CRI and Rg values.
- Drive current is referred to as nominal drive current.
- Typical stabilized DC performance values are provided as reference only and are not a guarantee of performance.
- Typical performance is estimated based on operation under DC (direct current) with LED array mounted onto a heat sink with thermal interface material and the case temperature maintained at  $85^\circ\text{C}$ . Based on Bridgelux test setup, values may vary depending on the thermal design of the luminaire and/or the exposed environment to which the product is subjected.
- Minimum flux values at elevated temperatures are provided for reference only and are not guaranteed by 100% production testing. Based on Bridgelux test setup, values may vary depending on the thermal design of the luminaire and/or the exposed environment to which the product is subjected.
- Nominal CCT is defined by the Lighting Research Center's Class A definition. The center of the Class A color bin is on the corresponding isothermal line.
- GAI value is 80. To help ensure optimal fixture level performance, GAI is measured at the fixture level, on axis, at a case temperature of  $70^\circ\text{C}$ . GAI may vary depending on fixture design and performance.

# Product Selection Guide

**Table 3:** Selection Guide, Stabilized DC Performance ( $T_c = 85^\circ\text{C}$ )<sup>4,5</sup> (continued)

Part Number	Nominal CCT <sup>7</sup> (K)	CRI <sup>2</sup>	Nominal Drive Current <sup>3</sup> (mA)	Typical DC Flux <sup>4,5</sup> $T_c = 85^\circ\text{C}$ (lm)	Minimum DC Flux <sup>6</sup> $T_c = 85^\circ\text{C}$ (lm)	Typical $V_f$ (V)	Typical Power (W)	Typical Efficacy (lm/W)
BXRC-57C2001-B-74-SE	5700	70	450	2438	2194	33.9	15.3	160
BXRC-57C2001-C-74-SE	5700	70	630	3414	3072	33.9	21.4	160
BXRC-57C2001-D-74-SE	5700	70	500	2476	2228	30.9	15.5	160
BXRC-57E2001-B-74-SE	5700	80	450	2340	2106	33.9	15.3	153
BXRC-57E2001-C-74-SE	5700	80	630	3275	2948	33.9	21.4	153
BXRC-57E2001-D-74-SE	5700	80	500	2375	2138	30.9	15.5	154
BXRC-65C2001-B-74-SE	6500	70	450	2481	2232	33.9	15.3	163
BXRC-65C2001-C-74-SE	6500	70	630	3473	3125	33.9	21.4	163
BXRC-65C2001-D-74-SE	6500	70	500	2519	2267	30.9	15.5	163
BXRC-65E2001-B-74-SE	6500	80	450	2382	2144	33.9	15.3	156
BXRC-65E2001-C-74-SE	6500	80	630	3335	3001	33.9	21.4	156
BXRC-65E2001-D-74-SE	6500	80	500	2418	2177	30.9	15.5	156

Notes for Table 3:

- Nominal CCT as defined by ANSI C78.377-2011. Products with a CCT of 5000K-6500K are hot targeted to  $T_c = 85^\circ\text{C}$ .
- All CRI values are measured at  $T_1 - T_c = 25^\circ\text{C}$ . CRI values are typical for Decor Series Ultra, Decor Series Street and Landmark and Decor Series Class A products. CRI values are minimums for all other products. Minimum Rg value for 80 CRI products is 0, the minimum Rg value for 90 CRI products is 50, the minimum Rg value for 97 CRI products is 93. Bridgelux maintains a  $\pm 3$  tolerance on CRI and Rg values.
- Drive current is referred to as nominal drive current.
- Typical stabilized DC performance values are provided as reference only and are not a guarantee of performance.
- Typical performance is estimated based on operation under DC (direct current) with LED array mounted onto a heat sink with thermal interface material and the case temperature maintained at  $85^\circ\text{C}$ . Based on Bridgelux test setup, values may vary depending on the thermal design of the luminaire and/or the exposed environment to which the product is subjected.
- Minimum flux values at elevated temperatures are provided for reference only and are not guaranteed by 100% production testing. Based on Bridgelux test setup, values may vary depending on the thermal design of the luminaire and/or the exposed environment to which the product is subjected.
- Nominal CCT is defined by the Lighting Research Center's Class A definition. The center of the Class A color bin is on the corresponding isothermal line.
- GAI value is 80. To help ensure optimal fixture level performance, GAI is measured at the fixture level, on axis, at a case temperature of  $70^\circ\text{C}$ . GAI may vary depending on fixture design and performance.

# Performance at Commonly Used Drive Currents

Vero SE LED arrays are tested to the specifications shown using the nominal drive currents in Table 1. Vero SE may also be driven at other drive currents dependent on specific application design requirements. The performance at any drive current can be derived from the current vs. voltage characteristics shown in Figures 1, 2 & 3 and the flux vs. current characteristics shown in Figures 4, 5 & 6. The performance at commonly used drive currents is summarized in Table 4.

**Table 4:** Product Performance at Commonly Used Drive Currents

Part Number	CRI	Drive Current <sup>1</sup> (mA)	Typical V <sub>f</sub> T <sub>c</sub> = 25°C (V)	Typical Power T <sub>c</sub> = 25°C (W)	Typical Flux <sup>2</sup> T <sub>c</sub> = 25°C (lm)	Typical DC Flux <sup>3</sup> T <sub>c</sub> = 85°C (lm)	Typical Efficacy T <sub>c</sub> = 25°C (lm/W)
BXRC-27E2000-B-7X	80	113	32.1	3.6	644	590	178
		225	33.0	7.4	1247	1131	168
		<b>450</b>	<b>34.8</b>	<b>15.7</b>	<b>2365</b>	<b>2128</b>	<b>151</b>
		675	36.1	24.3	3417	2993	140
		900	37.3	33.6	4359	3744	130
BXRC-27E2000-C-7X	80	158	32.1	5.1	894	846	177
		315	33.0	10.4	1732	1631	166
		<b>630</b>	<b>34.8</b>	<b>21.9</b>	<b>3311</b>	<b>2979</b>	<b>151</b>
		945	36.1	34.1	4752	4442	139
		1260	37.3	47.0	6064	5651	129
BXRC-27E2000-D-7X	80	125	29.6	3.7	636	607	172
		250	30.3	7.6	1232	1173	162
		<b>500</b>	<b>31.8</b>	<b>15.9</b>	<b>2401</b>	<b>2161</b>	<b>151</b>
		750	33.2	24.9	3393	3214	136
		1000	34.4	34.4	4338	4100	126
BXRC-27G20H0-B-7X	90	113	32.1	3.6	554	508	153
		225	33.0	7.4	1073	973	144
		<b>450</b>	<b>34.8</b>	<b>15.7</b>	<b>2036</b>	<b>1832</b>	<b>130</b>
		675	36.1	24.3	2942	2576	121
		900	37.3	33.6	3753	3223	112
BXRC-27G20H0-C-7X	90	158	32.1	5.1	770	728	152
		315	33.0	10.4	1491	1404	143
		<b>630</b>	<b>34.8</b>	<b>21.9</b>	<b>2850</b>	<b>2565</b>	<b>130</b>
		945	36.1	34.1	4091	3824	120
		1260	37.3	47.0	5221	4865	111
BXRC-27G20H0-D-7X	90	125	29.6	3.7	547	523	148
		250	30.3	7.6	1061	1010	140
		<b>500</b>	<b>31.8</b>	<b>15.9</b>	<b>2067</b>	<b>1860</b>	<b>130</b>
		750	33.2	24.9	2921	2767	117
		1000	34.4	34.4	3735	3529	108
BXRC-27G2000-B-7X	90	113	32.1	3.6	537	492	149
		225	33.0	7.4	1040	943	140
		<b>450</b>	<b>34.8</b>	<b>15.7</b>	<b>1973</b>	<b>1776</b>	<b>126</b>
		675	36.1	24.3	2852	2497	117
		900	37.3	33.6	3637	3124	108
BXRC-27G2000-C-7X	90	158	32.1	5.1	746	706	147
		315	33.0	10.4	1445	1361	139
		<b>630</b>	<b>34.8</b>	<b>21.9</b>	<b>2762</b>	<b>2486</b>	<b>126</b>
		945	36.1	34.1	3965	3707	116
		1260	37.3	47.0	5060	4715	108

Notes for Table 4:

1. Alternate drive currents are provided for reference only and are not a guarantee of performance.
2. Bridgelux maintains a ± 7% tolerance on flux measurements.
3. Typical stabilized DC performance values are provided as reference only and are not a guarantee of performance.

# Performance at Commonly Used Drive Currents

**Table 4:** Product Performance at Commonly Used Drive Currents (Continued)

Part Number	CRI	Drive Current <sup>1</sup> (mA)	Typical $V_f$ $T_c = 25^\circ\text{C}$ (V)	Typical Power $T_c = 25^\circ\text{C}$ (W)	Typical Flux <sup>2</sup> $T_c = 25^\circ\text{C}$ (lm)	Typical DC Flux <sup>3</sup> $T_c = 85^\circ\text{C}$ (lm)	Typical Efficacy $T_c = 25^\circ\text{C}$ (lm/W)
BXRC-27G2000-D-7X	90	125	29.6	3.7	530	506	144
		250	30.3	7.6	1028	979	136
		<b>500</b>	<b>31.8</b>	<b>15.9</b>	<b>2003</b>	<b>1803</b>	<b>126</b>
		750	33.2	24.9	2831	2682	114
		1000	34.4	34.4	3620	3421	105
BXRC-27H2000-B-7X-SE	80	113	32.1	3.6	465	426	129
		225	33.0	7.4	900	816	121
		<b>450</b>	<b>34.8</b>	<b>15.7</b>	<b>1707</b>	<b>1536</b>	<b>109</b>
		675	36.1	24.3	2467	2160	101
		900	37.3	33.6	3147	2703	94
BXRC-27H2000-C-7X-SE	80	158	32.1	5.1	646	610	128
		315	33.0	10.4	1250	1177	120
		<b>630</b>	<b>34.8</b>	<b>21.9</b>	<b>2390</b>	<b>2151</b>	<b>109</b>
		945	36.1	34.1	3430	3207	101
		1260	37.3	47.0	4378	4079	93
BXRC-27H2000-D-7X-SE	80	125	29.6	3.7	459	438	124
		250	30.3	7.6	889	847	117
		<b>500</b>	<b>31.8</b>	<b>15.9</b>	<b>1733</b>	<b>1560</b>	<b>109</b>
		750	33.2	24.9	2449	2320	98
		1000	34.4	34.4	3132	2959	91
BXRC-30C2001-B-74-SE	70	113	32.1	3.6	734	672	203
		225	33.0	7.4	1420	1288	191
		<b>450</b>	<b>34.8</b>	<b>15.7</b>	<b>2694</b>	<b>2424</b>	<b>172</b>
		675	36.1	24.3	3893	3409	160
		900	37.3	33.6	4965	4265	148
BXRC-30C2001-C-74-SE	70	158	32.1	5.1	1019	963	201
		315	33.0	10.4	1972	1857	190
		<b>630</b>	<b>34.8</b>	<b>21.9</b>	<b>3771</b>	<b>3394</b>	<b>172</b>
		945	36.1	34.1	5412	5060	159
		1260	37.3	47.0	6908	6437	147
BXRC-30C2001-D-74-SE	70	125	29.6	3.7	724	691	196
		250	30.3	7.6	1403	1337	185
		<b>500</b>	<b>31.8</b>	<b>15.9</b>	<b>2735</b>	<b>2461</b>	<b>172</b>
		750	33.2	24.9	3865	3661	155
		1000	34.4	34.4	4942	4670	144
BXRC-30E2000-B-7X-SE	80	113	32.1	3.6	670	614	185
		225	33.0	7.4	1296	1175	174
		<b>450</b>	<b>34.8</b>	<b>15.7</b>	<b>2459</b>	<b>2213</b>	<b>157</b>
		675	36.1	24.3	3553	3112	146
		900	37.3	33.6	4532	3893	135
BXRC-30E2000-C-7X-SE	80	158	32.1	5.1	930	879	184
		315	33.0	10.4	1800	1695	173
		<b>630</b>	<b>34.8</b>	<b>21.9</b>	<b>3442</b>	<b>3098</b>	<b>157</b>
		945	36.1	34.1	4940	4619	145
		1260	37.3	47.0	6305	5875	134

Notes for Table 4:

1. Alternate drive currents are provided for reference only and are not a guarantee of performance.
2. Bridgelux maintains a  $\pm 7\%$  tolerance on flux measurements.
3. Typical stabilized DC performance values are provided as reference only and are not a guarantee of performance.

# Performance at Commonly Used Drive Currents

**Table 4:** Product Performance at Commonly Used Drive Currents (Continued)

Part Number	CRI	Drive Current <sup>1</sup> (mA)	Typical $V_f$ $T_c = 25^\circ\text{C}$ (V)	Typical Power $T_c = 25^\circ\text{C}$ (W)	Typical Flux <sup>2</sup> $T_c = 25^\circ\text{C}$ (lm)	Typical DC Flux <sup>3</sup> $T_c = 85^\circ\text{C}$ (lm)	Typical Efficacy $T_c = 25^\circ\text{C}$ (lm/W)
BXRC-30E2000-D-7X-SE	80	125	29.6	3.7	661	631	179
		250	30.3	7.6	1281	1220	169
		<b>500</b>	<b>31.8</b>	<b>15.9</b>	<b>2496</b>	<b>2247</b>	<b>157</b>
		750	33.2	24.9	3528	3342	142
		1000	34.4	34.4	4511	4262	131
BXRC-30G20H0-B-7X	90	113	32.1	3.6	584	535	162
		225	33.0	7.4	1131	1026	152
		<b>450</b>	<b>34.8</b>	<b>15.7</b>	<b>2145</b>	<b>1931</b>	<b>137</b>
		675	36.1	24.3	3100	2715	127
		900	37.3	33.6	3955	3397	118
BXRC-30G20H0-C-7X	90	158	32.1	5.1	812	767	160
		315	33.0	10.4	1571	1479	151
		<b>630</b>	<b>34.8</b>	<b>21.9</b>	<b>3004</b>	<b>2703</b>	<b>137</b>
		945	36.1	34.1	4311	4030	126
		1260	37.3	47.0	5502	5127	117
BXRC-30G20H0-D-7X	90	125	29.6	3.7	577	551	156
		250	30.3	7.6	1118	1065	147
		<b>500</b>	<b>31.8</b>	<b>15.9</b>	<b>2178</b>	<b>1960</b>	<b>137</b>
		750	33.2	24.9	3078	2916	124
		1000	34.4	34.4	3936	3719	114
BXRC-30G2000-B-7X-SE	90	113	32.1	3.6	559	512	155
		225	33.0	7.4	1081	981	146
		<b>450</b>	<b>34.8</b>	<b>15.7</b>	<b>2051</b>	<b>1846</b>	<b>131</b>
		675	36.1	24.3	2965	2596	122
		900	37.3	33.6	3782	3248	113
BXRC-30G2000-C-7X-SE	90	158	32.1	5.1	776	734	153
		315	33.0	10.4	1502	1415	144
		<b>630</b>	<b>34.8</b>	<b>21.9</b>	<b>2872</b>	<b>2585</b>	<b>131</b>
		945	36.1	34.1	4122	3854	121
		1260	37.3	47.0	5261	4902	112
BXRC-30G2000-D-7X-SE	90	125	29.6	3.7	551	527	149
		250	30.3	7.6	1069	1018	141
		<b>500</b>	<b>31.8</b>	<b>15.9</b>	<b>2083</b>	<b>1875</b>	<b>131</b>
		750	33.2	24.9	2943	2788	118
		1000	34.4	34.4	3764	3557	109
BXRC-30G200C-B-73-SE	90	113	32.1	3.6	519	476	144
		225	33.0	7.4	1005	911	135
		<b>450</b>	<b>34.8</b>	<b>15.7</b>	<b>1906</b>	<b>1715</b>	<b>122</b>
		675	36.1	24.3	2754	2412	113
		900	37.3	33.6	3513	3018	105
BXRC-30G200C-D-73-SE	90	125	29.6	3.7	509	486	138
		250	30.3	7.6	987	940	130
		<b>500</b>	<b>31.8</b>	<b>15.9</b>	<b>1924</b>	<b>1732</b>	<b>121</b>
		750	33.2	24.9	2719	2576	109
		1000	34.4	34.4	3476	3285	101

Notes for Table 4:

1. Alternate drive currents are provided for reference only and are not a guarantee of performance.
2. Bridgelux maintains a  $\pm 7\%$  tolerance on flux measurements.
3. Typical stabilized DC performance values are provided as reference only and are not a guarantee of performance.

# Performance at Commonly Used Drive Currents

**Table 4:** Product Performance at Commonly Used Drive Currents (Continued)

Part Number	CRI	Drive Current <sup>1</sup> (mA)	Typical $V_f$ $T_c = 25^\circ\text{C}$ (V)	Typical Power $T_c = 25^\circ\text{C}$ (W)	Typical Flux <sup>2</sup> $T_c = 25^\circ\text{C}$ (lm)	Typical DC Flux <sup>3</sup> $T_c = 85^\circ\text{C}$ (lm)	Typical Efficacy $T_c = 25^\circ\text{C}$ (lm/W)
BXRC-30H2000-B-7X-SE	80	113	32.1	3.6	499	457	138
		225	33.0	7.4	966	876	130
		<b>450</b>	<b>34.8</b>	<b>15.7</b>	<b>1832</b>	<b>1649</b>	<b>117</b>
		675	36.1	24.3	2648	2319	109
		900	37.3	33.6	3378	2901	101
BXRC-30H2000-C-7X-SE	80	158	32.1	5.1	693	655	137
		315	33.0	10.4	1342	1263	129
		<b>630</b>	<b>34.8</b>	<b>21.9</b>	<b>2565</b>	<b>2309</b>	<b>117</b>
		945	36.1	34.1	3682	3442	108
		1260	37.3	47.0	4699	4378	100
BXRC-30H2000-D-7X-SE	80	125	29.6	3.7	492	470	133
		250	30.3	7.6	955	909	126
		<b>500</b>	<b>31.8</b>	<b>15.9</b>	<b>1860</b>	<b>1674</b>	<b>117</b>
		750	33.2	24.9	2629	2490	106
		1000	34.4	34.4	3361	3176	98
BXRC-30A2001-B-73-SE	93	113	32.1	3.6	503	461	139
		225	33.0	7.4	974	883	131
		<b>450</b>	<b>34.8</b>	<b>15.7</b>	<b>1848</b>	<b>1663</b>	<b>118</b>
		675	36.1	24.3	2670	2339	110
		900	37.3	33.6	3406	2926	102
BXRC-30A2001-C-73-SE	93	158	32.1	5.1	699	661	138
		315	33.0	10.4	1353	1274	130
		<b>630</b>	<b>34.8</b>	<b>21.9</b>	<b>2587</b>	<b>2328</b>	<b>118</b>
		945	36.1	34.1	3713	3471	109
		1260	37.3	47.0	4739	4416	101
BXRC-30A2001-D-73-SE	93	125	29.6	3.7	497	474	134
		250	30.3	7.6	963	917	127
		<b>500</b>	<b>31.8</b>	<b>15.9</b>	<b>1876</b>	<b>1689</b>	<b>118</b>
		750	33.2	24.9	2651	2512	107
		1000	34.4	34.4	3390	3204	98
BXRC-35E2000-B-7X-SE	80	113	32.1	3.6	691	633	191
		225	33.0	7.4	1337	1213	180
		<b>450</b>	<b>34.8</b>	<b>15.7</b>	<b>2537</b>	<b>2283</b>	<b>162</b>
		675	36.1	24.3	3666	3211	151
		900	37.3	33.6	4677	4017	139
BXRC-35E2000-C-7X-SE	80	158	32.1	5.1	960	907	190
		315	33.0	10.4	1858	1749	179
		<b>630</b>	<b>34.8</b>	<b>21.9</b>	<b>3552</b>	<b>3197</b>	<b>162</b>
		945	36.1	34.1	5098	4766	150
		1260	37.3	47.0	6506	6062	139
BXRC-35E2000-D-7X-SE	80	125	29.6	3.7	682	651	185
		250	30.3	7.6	1322	1259	174
		<b>500</b>	<b>31.8</b>	<b>15.9</b>	<b>2576</b>	<b>2318</b>	<b>162</b>
		750	33.2	24.9	3640	3448	146
		1000	34.4	34.4	4654	4398	135

Notes for Table 4:

1. Alternate drive currents are provided for reference only and are not a guarantee of performance.
2. Bridgelux maintains a  $\pm 7\%$  tolerance on flux measurements.
3. Typical stabilized DC performance values are provided as reference only and are not a guarantee of performance.

# Performance at Commonly Used Drive Currents

**Table 4:** Product Performance at Commonly Used Drive Currents (Continued)

Part Number	CRI	Drive Current <sup>1</sup> (mA)	Typical $V_f$ $T_c = 25^\circ\text{C}$ (V)	Typical Power $T_c = 25^\circ\text{C}$ (W)	Typical Flux <sup>2</sup> $T_c = 25^\circ\text{C}$ (lm)	Typical DC Flux <sup>3</sup> $T_c = 85^\circ\text{C}$ (lm)	Typical Efficacy $T_c = 25^\circ\text{C}$ (lm/W)
BXRC-35G2000-B-7X-SE	90	113	32.1	3.6	576	528	159
		225	33.0	7.4	1114	1011	150
		<b>450</b>	<b>34.8</b>	<b>15.7</b>	<b>2114</b>	<b>1903</b>	<b>135</b>
		675	36.1	24.3	3055	2676	126
		900	37.3	33.6	3897	3347	116
BXRC-35G2000-C-7X-SE	90	158	32.1	5.1	800	756	158
		315	33.0	10.4	1548	1458	149
		<b>630</b>	<b>34.8</b>	<b>21.9</b>	<b>2960</b>	<b>2664</b>	<b>135</b>
		945	36.1	34.1	4248	3971	125
		1260	37.3	47.0	5422	5052	115
BXRC-35G2000-D-7X-SE	90	125	29.6	3.7	568	543	154
		250	30.3	7.6	1101	1049	145
		<b>500</b>	<b>31.8</b>	<b>15.9</b>	<b>2147</b>	<b>1932</b>	<b>135</b>
		750	33.2	24.9	3033	2874	122
		1000	34.4	34.4	3879	3665	113
BXRC-35A2001-B-73-SE	93	113	32.1	3.6	542	496	150
		225	33.0	7.4	1048	951	141
		<b>450</b>	<b>34.8</b>	<b>15.7</b>	<b>1989</b>	<b>1790</b>	<b>127</b>
		675	36.1	24.3	2874	2517	118
		900	37.3	33.6	3666	3149	109
BXRC-35A2001-C-73-SE	93	158	32.1	5.1	752	711	149
		315	33.0	10.4	1456	1371	140
		<b>630</b>	<b>34.8</b>	<b>21.9</b>	<b>2784</b>	<b>2506</b>	<b>127</b>
		945	36.1	34.1	3996	3736	117
		1260	37.3	47.0	5101	4753	109
BXRC-35A2001-D-73-SE	93	125	29.6	3.7	535	511	145
		250	30.3	7.6	1036	987	137
		<b>500</b>	<b>31.8</b>	<b>15.9</b>	<b>2019</b>	<b>1817</b>	<b>127</b>
		750	33.2	24.9	2854	2703	115
		1000	34.4	34.4	3649	3448	106
BXRC-40C2001-B-74-SE	70	113	32.1	3.6	755	692	209
		225	33.0	7.4	1461	1325	197
		<b>450</b>	<b>34.8</b>	<b>15.7</b>	<b>2772</b>	<b>2495</b>	<b>177</b>
		675	36.1	24.3	4006	3508	165
		900	37.3	33.6	5110	4389	152
BXRC-40C2001-C-74-SE	70	158	32.1	5.1	1048	991	207
		315	33.0	10.4	2030	1911	195
		<b>630</b>	<b>34.8</b>	<b>21.9</b>	<b>3881</b>	<b>3492</b>	<b>177</b>
		945	36.1	34.1	5570	5207	163
		1260	37.3	47.0	7109	6624	151
BXRC-40C2001-D-74-SE	70	125	29.6	3.7	745	711	202
		250	30.3	7.6	1444	1375	190
		<b>500</b>	<b>31.8</b>	<b>15.9</b>	<b>2814</b>	<b>2533</b>	<b>177</b>
		750	33.2	24.9	3977	3768	160
		1000	34.4	34.4	5085	4805	148

Notes for Table 4:

1. Alternate drive currents are provided for reference only and are not a guarantee of performance.
2. Bridgelux maintains a  $\pm 7\%$  tolerance on flux measurements.
3. Typical stabilized DC performance values are provided as reference only and are not a guarantee of performance.



# Performance at Commonly Used Drive Currents

**Table 4:** Product Performance at Commonly Used Drive Currents (Continued)

Part Number	CRI	Drive Current <sup>1</sup> (mA)	Typical V <sub>f</sub> T <sub>c</sub> = 25°C (V)	Typical Power T <sub>c</sub> = 25°C (W)	Typical Flux <sup>2</sup> T <sub>c</sub> = 25°C (lm)	Typical DC Flux <sup>3</sup> T <sub>c</sub> = 85°C (lm)	Typical Efficacy T <sub>c</sub> = 25°C (lm/W)
BXRC-40E2000-B-7X-SE	80	113	32.1	3.6	695	637	192
		225	33.0	7.4	1346	1220	181
		<b>450</b>	<b>34.8</b>	<b>15.7</b>	<b>2553</b>	<b>2297</b>	<b>163</b>
		675	36.1	24.3	3689	3231	152
		900	37.3	33.6	4705	4042	140
BXRC-40E2000-C-7X-SE	80	158	32.1	5.1	966	913	191
		315	33.0	10.4	1869	1760	180
		<b>630</b>	<b>34.8</b>	<b>21.9</b>	<b>3574</b>	<b>3216</b>	<b>163</b>
		945	36.1	34.1	5129	4795	151
		1260	37.3	47.0	6546	6100	139
BXRC-40E2000-D-7X-SE	80	125	29.6	3.7	686	655	186
		250	30.3	7.6	1330	1267	175
		<b>500</b>	<b>31.8</b>	<b>15.9</b>	<b>2592</b>	<b>2333</b>	<b>163</b>
		750	33.2	24.9	3662	3470	147
		1000	34.4	34.4	4683	4425	136
BXRC-40G2000-B-7X-SE	90	113	32.1	3.6	597	547	165
		225	33.0	7.4	1156	1048	156
		<b>450</b>	<b>34.8</b>	<b>15.7</b>	<b>2192</b>	<b>1973</b>	<b>140</b>
		675	36.1	24.3	3168	2775	130
		900	37.3	33.6	4041	3471	120
BXRC-40G2000-C-7X-SE	90	158	32.1	5.1	829	784	164
		315	33.0	10.4	1605	1512	154
		<b>630</b>	<b>34.8</b>	<b>21.9</b>	<b>3069</b>	<b>2762</b>	<b>140</b>
		945	36.1	34.1	4405	4118	129
		1260	37.3	47.0	5623	5239	120
BXRC-40G2000-D-7X-SE	90	125	29.6	3.7	589	563	160
		250	30.3	7.6	1142	1088	151
		<b>500</b>	<b>31.8</b>	<b>15.9</b>	<b>2226</b>	<b>2003</b>	<b>140</b>
		750	33.2	24.9	3146	2980	126
		1000	34.4	34.4	4022	3801	117
BXRC-40H2000-B-7X-SE	97	113	32.1	3.6	508	465	140
		225	33.0	7.4	982	891	132
		<b>450</b>	<b>34.8</b>	<b>15.7</b>	<b>1864</b>	<b>1677</b>	<b>119</b>
		675	36.1	24.3	2693	2358	111
		900	37.3	33.6	3435	2951	102
BXRC-40H2000-C-7X-SE	97	158	32.1	5.1	705	666	139
		315	33.0	10.4	1365	1285	131
		<b>630</b>	<b>34.8</b>	<b>21.9</b>	<b>2609</b>	<b>2348</b>	<b>119</b>
		945	36.1	34.1	3745	3501	110
		1260	37.3	47.0	4779	4453	102
BXRC-40H2000-D-7X-SE	97	125	29.6	3.7	501	478	136
		250	30.3	7.6	971	925	128
		<b>500</b>	<b>31.8</b>	<b>15.9</b>	<b>1892</b>	<b>1703</b>	<b>119</b>
		750	33.2	24.9	2674	2533	107
		1000	34.4	34.4	3419	3231	99

Notes for Table 4:

1. Alternate drive currents are provided for reference only and are not a guarantee of performance.
2. Bridgelux maintains a ± 7% tolerance on flux measurements.
3. Typical stabilized DC performance values are provided as reference only and are not a guarantee of performance.

# Performance at Commonly Used Drive Currents

**Table 4:** Product Performance at Commonly Used Drive Currents (Continued)

Part Number	CRI	Drive Current <sup>1</sup> (mA)	Typical $V_f$ $T_c = 25^\circ\text{C}$ (V)	Typical Power $T_c = 25^\circ\text{C}$ (W)	Typical Flux <sup>2</sup> $T_c = 25^\circ\text{C}$ (lm)	Typical DC Flux <sup>3</sup> $T_c = 85^\circ\text{C}$ (lm)	Typical Efficacy $T_c = 25^\circ\text{C}$ (lm/W)
BXRC-40A2001-B-73-SE	93	113	32.1	3.6	580	532	160
		225	33.0	7.4	1123	1018	151
		<b>450</b>	<b>34.8</b>	<b>15.7</b>	<b>2130</b>	<b>1917</b>	<b>136</b>
		675	36.1	24.3	3078	2695	126
		900	37.3	33.6	3926	3372	117
BXRC-40A2001-C-73-SE	93	158	32.1	5.1	806	762	159
		315	33.0	10.4	1560	1469	150
		<b>630</b>	<b>34.8</b>	<b>21.9</b>	<b>2982</b>	<b>2683</b>	<b>136</b>
		945	36.1	34.1	4280	4001	126
		1260	37.3	47.0	5462	5089	116
BXRC-40A2001-D-73-SE	93	125	29.6	3.7	572	547	155
		250	30.3	7.6	1110	1057	146
		<b>500</b>	<b>31.8</b>	<b>15.9</b>	<b>2162</b>	<b>1946</b>	<b>136</b>
		750	33.2	24.9	3056	2895	123
		1000	34.4	34.4	3907	3692	113
BXRC-50C2001-B-74-SE	70	113	32.1	3.6	763	700	211
		225	33.0	7.4	1478	1340	199
		<b>450</b>	<b>34.8</b>	<b>15.7</b>	<b>2803</b>	<b>2523</b>	<b>179</b>
		675	36.1	24.3	4051	3548	166
		900	37.3	33.6	5167	4438	154
BXRC-50C2001-C-74-SE	70	158	32.1	5.1	1060	1002	210
		315	33.0	10.4	2053	1933	197
		<b>630</b>	<b>34.8</b>	<b>21.9</b>	<b>3924</b>	<b>3532</b>	<b>179</b>
		945	36.1	34.1	5633	5266	165
		1260	37.3	47.0	7189	6698	153
BXRC-50C2001-D-74-SE	70	125	29.6	3.7	753	720	204
		250	30.3	7.6	1460	1391	193
		<b>500</b>	<b>31.8</b>	<b>15.9</b>	<b>2846</b>	<b>2561</b>	<b>179</b>
		750	33.2	24.9	4022	3810	162
		1000	34.4	34.4	5143	4860	149
BXRC-50E2001-B-74-SE	80	113	32.1	3.6	716	657	198
		225	33.0	7.4	1387	1258	187
		<b>450</b>	<b>34.8</b>	<b>15.7</b>	<b>2631</b>	<b>2368</b>	<b>168</b>
		675	36.1	24.3	3802	3330	156
		900	37.3	33.6	4850	4166	145
BXRC-50E2001-C-74-SE	80	158	32.1	5.1	995	941	197
		315	33.0	10.4	1927	1814	185
		<b>630</b>	<b>34.8</b>	<b>21.9</b>	<b>3683</b>	<b>3315</b>	<b>168</b>
		945	36.1	34.1	5287	4942	155
		1260	37.3	47.0	6747	6287	144
BXRC-50E2001-D-74-SE	80	125	29.6	3.7	707	675	191
		250	30.3	7.6	1371	1306	181
		<b>500</b>	<b>31.8</b>	<b>15.9</b>	<b>2671</b>	<b>2404</b>	<b>168</b>
		750	33.2	24.9	3775	3576	152
		1000	34.4	34.4	4827	4561	140

Notes for Table 4:

1. Alternate drive currents are provided for reference only and are not a guarantee of performance.
2. Bridgelux maintains a  $\pm 7\%$  tolerance on flux measurements.
3. Typical stabilized DC performance values are provided as reference only and are not a guarantee of performance.

# Performance at Commonly Used Drive Currents

**Table 4:** Product Performance at Commonly Used Drive Currents (Continued)

Part Number	CRI	Drive Current <sup>1</sup> (mA)	Typical $V_f$ $T_c = 25^\circ\text{C}$ (V)	Typical Power $T_c = 25^\circ\text{C}$ (W)	Typical Flux <sup>2</sup> $T_c = 25^\circ\text{C}$ (lm)	Typical DC Flux <sup>3</sup> $T_c = 85^\circ\text{C}$ (lm)	Typical Efficacy $T_c = 25^\circ\text{C}$ (lm/W)
BXRC-50G2001-B-74-SE	90	113	32.1	3.6	610	559	169
		225	33.0	7.4	1180	1071	159
		<b>450</b>	<b>34.8</b>	<b>15.7</b>	<b>2239</b>	<b>2015</b>	<b>143</b>
		675	36.1	24.3	3236	2834	133
		900	37.3	33.6	4128	3546	123
BXRC-50G2001-C-74-SE	90	158	32.1	5.1	847	801	167
		315	33.0	10.4	1640	1544	158
		<b>630</b>	<b>34.8</b>	<b>21.9</b>	<b>3135</b>	<b>2822</b>	<b>143</b>
		945	36.1	34.1	4500	4207	132
		1260	37.3	47.0	5743	5351	122
BXRC-50G2001-D-74-SE	90	125	29.6	3.7	602	575	163
		250	30.3	7.6	1167	1111	154
		<b>500</b>	<b>31.8</b>	<b>15.9</b>	<b>2274</b>	<b>2046</b>	<b>143</b>
		750	33.2	24.9	3213	3044	129
		1000	34.4	34.4	4108	3882	119
BXRC-57C2001-B-74-SE	70	113	32.1	3.6	738	676	204
		225	33.0	7.4	1428	1295	192
		<b>450</b>	<b>34.8</b>	<b>15.7</b>	<b>2709</b>	<b>2438</b>	<b>173</b>
		675	36.1	24.3	3915	3429	161
		900	37.3	33.6	4994	4290	149
BXRC-57C2001-C-74-SE	70	158	32.1	5.1	1025	969	202
		315	33.0	10.4	1984	1868	191
		<b>630</b>	<b>34.8</b>	<b>21.9</b>	<b>3793</b>	<b>3414</b>	<b>173</b>
		945	36.1	34.1	5444	5089	160
		1260	37.3	47.0	6948	6474	148
BXRC-57C2001-D-74-SE	70	125	29.6	3.7	728	695	197
		250	30.3	7.6	1412	1344	186
		<b>500</b>	<b>31.8</b>	<b>15.9</b>	<b>2751</b>	<b>2476</b>	<b>173</b>
		750	33.2	24.9	3887	3682	156
		1000	34.4	34.4	4970	4697	144
BXRC-57E2001-B-74-SE	80	113	32.1	3.6	708	649	196
		225	33.0	7.4	1370	1243	184
		<b>450</b>	<b>34.8</b>	<b>15.7</b>	<b>2600</b>	<b>2340</b>	<b>166</b>
		675	36.1	24.3	3757	3290	154
		900	37.3	33.6	4792	4116	143
BXRC-57E2001-C-74-SE	80	158	32.1	5.1	983	930	194
		315	33.0	10.4	1904	1793	183
		<b>630</b>	<b>34.8</b>	<b>21.9</b>	<b>3639</b>	<b>3275</b>	<b>166</b>
		945	36.1	34.1	5224	4883	153
		1260	37.3	47.0	6667	6212	142
BXRC-57E2001-D-74-SE	80	125	29.6	3.7	699	667	189
		250	30.3	7.6	1354	1290	179
		<b>500</b>	<b>31.8</b>	<b>15.9</b>	<b>2639</b>	<b>2375</b>	<b>166</b>
		750	33.2	24.9	3730	3533	150
		1000	34.4	34.4	4769	4507	139

Notes for Table 4:

1. Alternate drive currents are provided for reference only and are not a guarantee of performance.
2. Bridgelux maintains a  $\pm 7\%$  tolerance on flux measurements.
3. Typical stabilized DC performance values are provided as reference only and are not a guarantee of performance.

# Performance at Commonly Used Drive Currents

**Table 4:** Product Performance at Commonly Used Drive Currents (Continued)

Part Number	CRI	Drive Current <sup>1</sup> (mA)	Typical V <sub>f</sub> T <sub>c</sub> = 25°C (V)	Typical Power T <sub>c</sub> = 25°C (W)	Typical Flux <sup>2</sup> T <sub>c</sub> = 25°C (lm)	Typical DC Flux <sup>3</sup> T <sub>c</sub> = 85°C (lm)	Typical Efficacy T <sub>c</sub> = 25°C (lm/W)
BXRC-65C2001-B-74-SE	70	113	32.1	3.6	751	688	208
		225	33.0	7.4	1453	1318	196
		<b>450</b>	<b>34.8</b>	<b>15.7</b>	<b>2756</b>	<b>2481</b>	<b>176</b>
		675	36.1	24.3	3983	3488	164
		900	37.3	33.6	5081	4364	151
BXRC-65C2001-C-74-SE	70	158	32.1	5.1	1043	986	206
		315	33.0	10.4	2018	1901	194
		<b>630</b>	<b>34.8</b>	<b>21.9</b>	<b>3859</b>	<b>3473</b>	<b>176</b>
		945	36.1	34.1	5538	5177	163
		1260	37.3	47.0	7069	6586	150
BXRC-65C2001-D-74-SE	70	125	29.6	3.7	741	707	201
		250	30.3	7.6	1436	1368	189
		<b>500</b>	<b>31.8</b>	<b>15.9</b>	<b>2798</b>	<b>2519</b>	<b>176</b>
		750	33.2	24.9	3955	3746	159
		1000	34.4	34.4	5056	4778	147
BXRC-65E2001-B-74-SE	80	113	32.1	3.6	721	661	199
		225	33.0	7.4	1395	1265	188
		<b>450</b>	<b>34.8</b>	<b>15.7</b>	<b>2647</b>	<b>2382</b>	<b>169</b>
		675	36.1	24.3	3825	3349	157
		900	37.3	33.6	4879	4191	145
BXRC-65E2001-C-74-SE	80	158	32.1	5.1	1001	946	198
		315	33.0	10.4	1938	1825	186
		<b>630</b>	<b>34.8</b>	<b>21.9</b>	<b>3705</b>	<b>3335</b>	<b>169</b>
		945	36.1	34.1	5318	4972	156
		1260	37.3	47.0	6787	6324	144
BXRC-65E2001-D-74-SE	80	125	29.6	3.7	711	679	193
		250	30.3	7.6	1379	1313	182
		<b>500</b>	<b>31.8</b>	<b>15.9</b>	<b>2687</b>	<b>2418</b>	<b>169</b>
		750	33.2	24.9	3797	3597	153
		1000	34.4	34.4	4855	4588	141

Notes for Table 4:

1. Alternate drive currents are provided for reference only and are not a guarantee of performance.
2. Bridgelux maintains a ± 7% tolerance on flux measurements.
3. Typical stabilized DC performance values are provided as reference only and are not a guarantee of performance.

# Electrical Characteristics

**Table 5:** Electrical Characteristics

Part Number	Drive Current (mA)	Forward Voltage Pulsed, $T_c = 25^\circ\text{C}$ (V) <sup>1, 2, 3, 8</sup>			Typical Coefficient of Forward Voltage <sup>4</sup> $\Delta V_f / \Delta T_c$ (mV/ $^\circ\text{C}$ )	Typical Thermal Resistance Junction to Case <sup>5,6</sup> $R_{j-c}$ ( $^\circ\text{C}/\text{W}$ )	Driver Selection Voltages <sup>7</sup> (V)	
		Minimum	Typical	Maximum			$V_f$ Min. Hot $T_c = 105^\circ\text{C}$ (V)	$V_f$ Max. Cold $T_c = -40^\circ\text{C}$ (V)
BXRC-xxx200x-B-7x-SE	450	32.2	34.8	37.4	-14.3	0.28	31.0	38.3
	900	34.5	37.3	40.1	-14.3	0.35	33.4	41.0
BXRC-xxx200x-C-7x-SE	630	32.2	34.8	37.4	-14.3	0.20	31.0	38.3
	1260	34.5	37.3	40.1	-14.3	0.24	33.4	41.0
BXRC-xxx200x-D-7x-SE	500	29.4	31.8	34.2	-13.3	0.34	28.4	35.0
	1000	31.8	34.4	37.0	-13.3	0.41	30.8	37.9

Notes for Table 5:

- Parts are tested in pulsed conditions.  $T_c = 25^\circ\text{C}$ . Pulse width is 10ms.
- Voltage minimum and maximum are provided for reference only and are not a guarantee of performance.
- Bridgelux maintains a tester tolerance of  $\pm 0.10\text{V}$  on forward voltage measurements.
- Typical coefficient of forward voltage tolerance is  $\pm 0.1\text{mV}$  for nominal current.
- Thermal resistance values are based from test data of a 3000K 80 CRI product.
- Thermal resistance value was calculated using total electrical input power; optical power was not subtracted from input power. The thermal interface material used during testing is not included in the thermal resistance value.
- $V_f$  min hot and max cold values are provided as reference only and are not guaranteed by test. These values are provided to aid in driver design and selection over the operating range of the product.
- This product has been designed and manufactured per IEC 62031:2014. This product has passed dielectric withstand voltage testing at 1160 V. The working voltage designated for the insulation is 80V d.c. The maximum allowable voltage across the array must be determined in the end product application.

# Eye Safety

**Table 6:** Eye Safety Risk Group (RG) Classifications

Part Number	Drive Current <sup>5</sup> (mA)	CCT <sup>1-5</sup>			
		2700K/3000K	4000K <sup>2</sup>	5000K <sup>3</sup>	6500K <sup>4</sup>
BXRC-xxx200x-B-7x-SE	450	RG1	RG1	RG1	RG1
	675	RG1	RG1	RG1	RG2
	900	RG1	RG1	RG2	RG2
BXRC-xxx200x-C-7x-SE	630	RG1	RG1	RG1	RG1
	945	RG1	RG1	RG2	RG2
	1260	RG1	RG2	RG2	RG2
BXRC-xxx200x-D-7x-SE	500	RG1	RG1	RG1	RG1
	750	RG1	RG1	RG1	RG2
	1000	RG1	RG1	RG2	RG2

Notes for Table 6:

1. Eye safety classification for the use of Bridgelux Vero SE Series LED arrays is in accordance with specification IEC/TR 62778: Application of IEC 62471 for the assessment of blue light hazard to light sources and luminaires.
2. For products classified as RG2 at 4000K,  $E_{thr} = 1847.5$  lx.
3. For products classified as RG2 at 5000K  $E_{thr} = 1315.8$  lx.
4. For products classified as RG2 at 6500K,  $E_{thr} = 1124.5$  lx.
5. Please contact your Bridgelux sales representative for  $E_{thr}$  values at specific drive currents and CCTs not listed.

# Absolute Maximum Ratings

**Table 7:** Maximum Ratings

Parameter	Maximum Rating		
LED Junction Temperature (T <sub>j</sub> )	150°C		
Storage Temperature	-40°C to +105°C		
Operating Case Temperature <sup>1</sup> (T <sub>c</sub> )	105°C		
	BXRC-xxx200x-B-7x-SE	BXRC-xxx200x-C-7x-SE	BXRC-xxx200x-D-7x-SE
Maximum Drive Current <sup>3</sup>	900mA	1260mA	1000mA
Maximum Peak Pulsed Drive Current <sup>4</sup>	1290mA	1800mA	1430mA
Maximum Reverse Voltage <sup>5</sup>	-60V	-60V	-55V

Notes for Table 7:

1. For IEC 62717 requirement, please consult your Bridgelux sales representative.
2. Refer to Bridgelux Application Note AN120: Assembly Considerations for Bridgelux Vero SE LED Arrays.
3. Arrays may be driven at higher currents however lumen maintenance may be reduced.
4. Bridgelux recommends a maximum duty cycle of 10% and pulse width of 20 ms when operating LED Arrays at maximum peak pulsed current specified. Maximum peak pulsed currents indicate values where LED Arrays can be driven without catastrophic failures.
5. Light emitting diodes are not designed to be driven in reverse voltage and will not produce light under this condition. Maximum rating provided for reference only.

# Performance Curves

**Figure 1: Vero SE 13B Drive Current vs. Voltage**

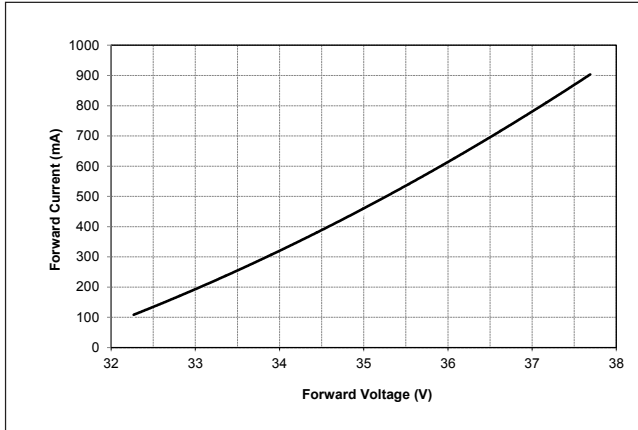

**Figure 2: Vero SE 13C Drive Current vs. Voltage**

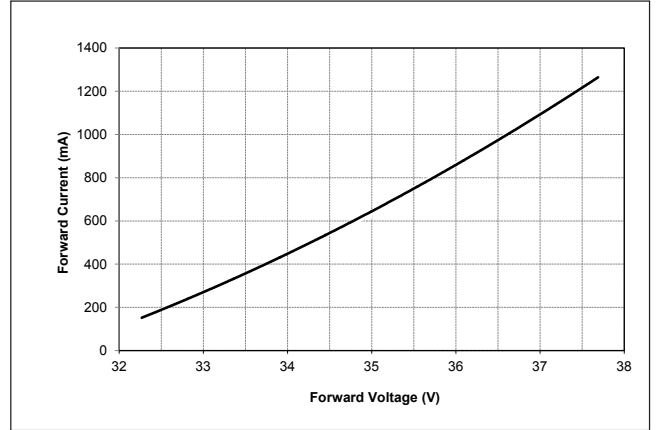

**Figure 3: Vero SE 13D Drive Current vs. Voltage**

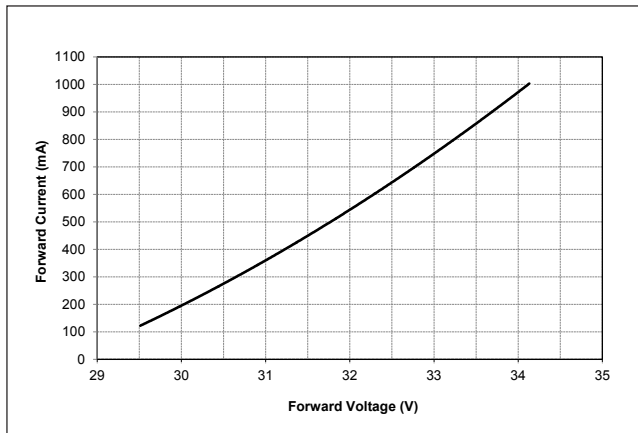

**Figure 4: Vero SE 13B Typical Relative Flux vs. Current**

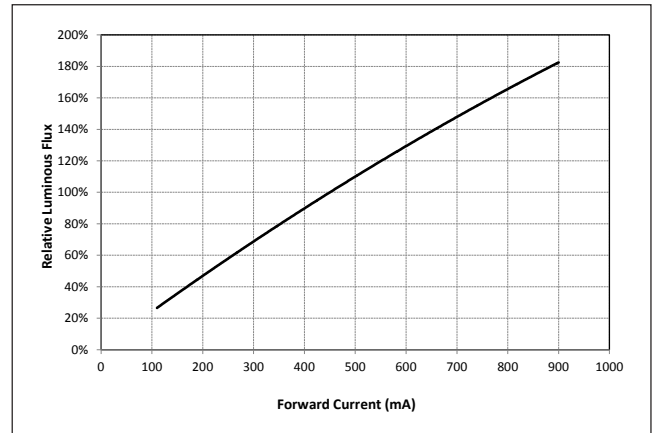

**Figure 5: Vero SE 13C Typical Relative Flux vs. Current**

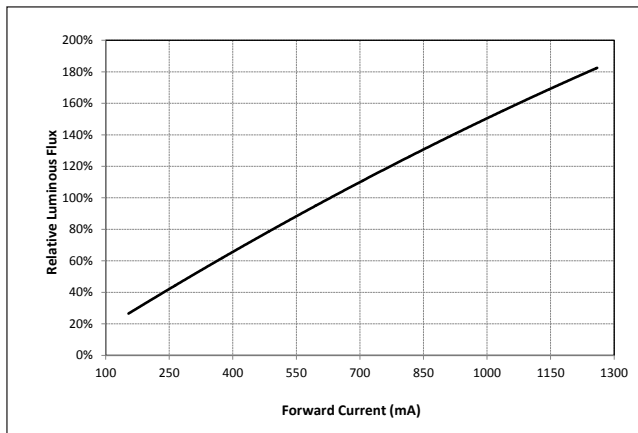

**Figure 6 Vero SE 13D Typical Relative Flux vs. Current**

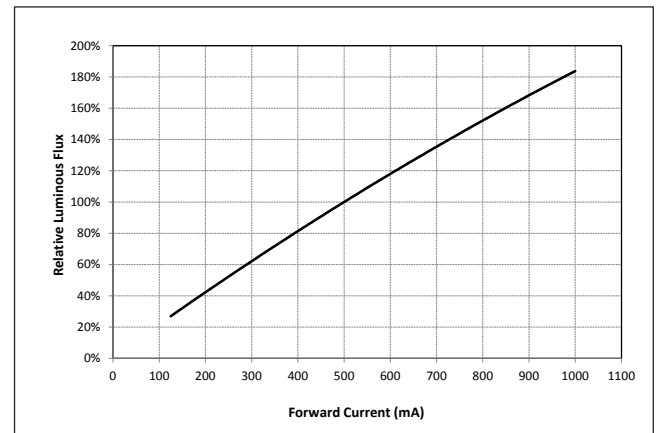

Notes for Figures 1-6:

1. Bridgelux does not recommend driving high power LEDs at low currents. Doing so may produce unpredictable results. Pulse width modulation (PWM) is recommended for dimming effects.
2. Products tested under pulsed condition (10ms pulse width) at nominal test current where  $T_j$  (junction temperature) -  $T_c$  (case temperature) = 25°C.



# Performance Curves

**Figure 7: Typical DC Flux vs. Case Temperature**

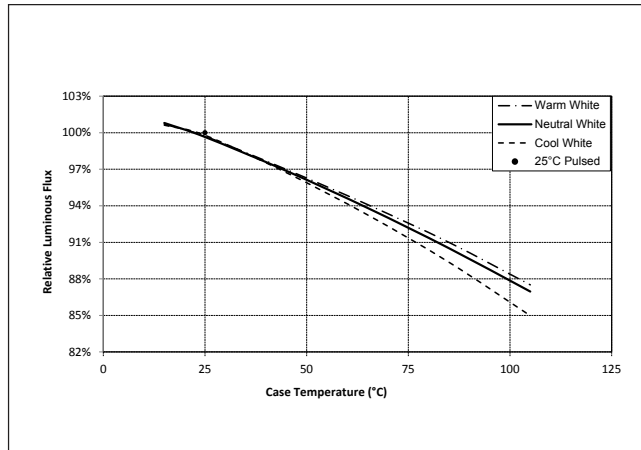

**Figure 8: Typical DC ccy Shift vs. Case Temperature**

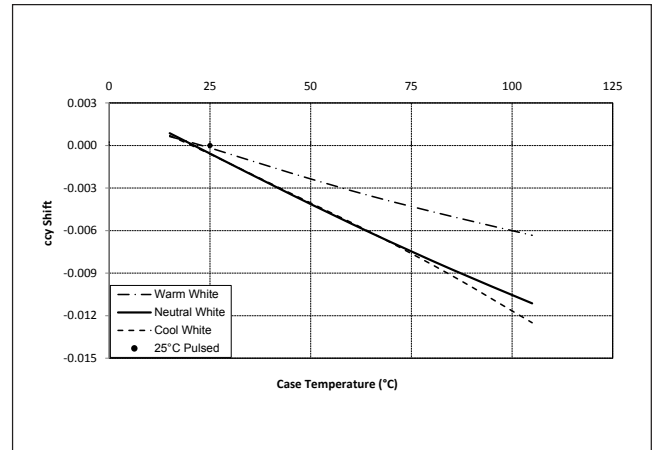

**Figure 9: Typical DC ccx Shift vs. Case Temperature**

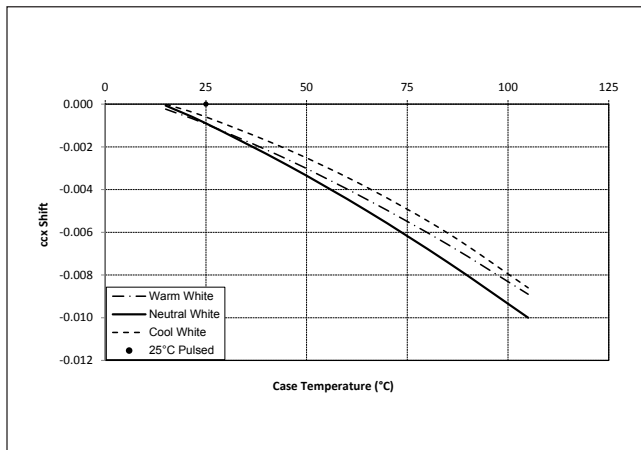

Notes for Figures 7 - 9:

1. Characteristics shown for warm white based on 3000K and 80 CRI.
2. Characteristics shown for neutral white based on 4000K and 80 CRI.
3. Characteristics shown for cool white based on 5000K and 70 CRI.
4. For other color SKUs, the shift in color will vary. Please contact your Bridgelux Sales Representative for more information.

# Performance Curves

**Figure 10: 2700K, 97 CRI Color Shift vs. Case Temperature<sup>1</sup>**

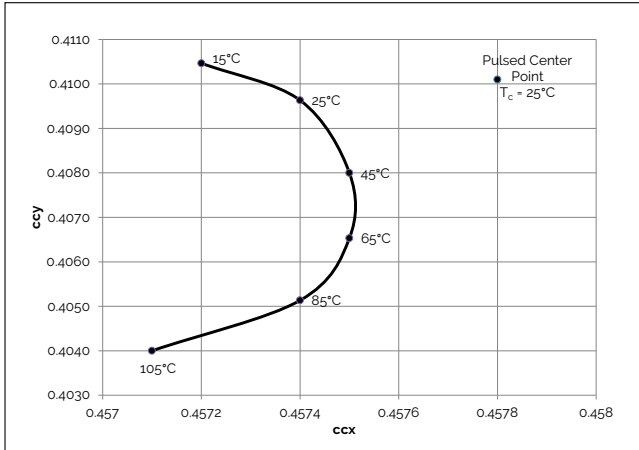

**Figure 11: 3000K, 97 CRI Color Shift vs. Case Temperature<sup>1</sup>**

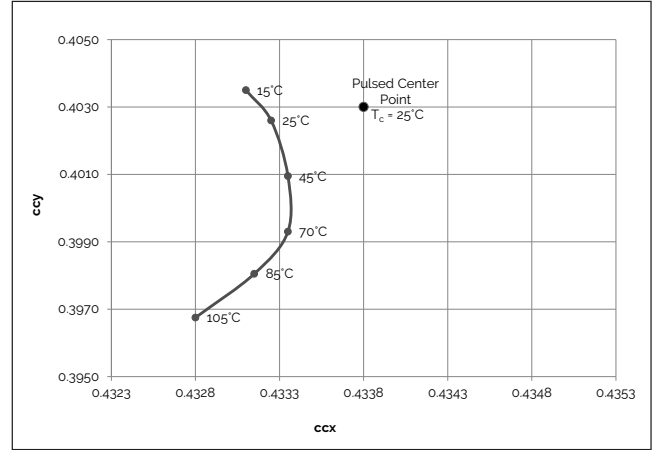

**Figure 12: 3000K, 90 CRI Color Shift vs. Case Temperature<sup>1,3</sup>**

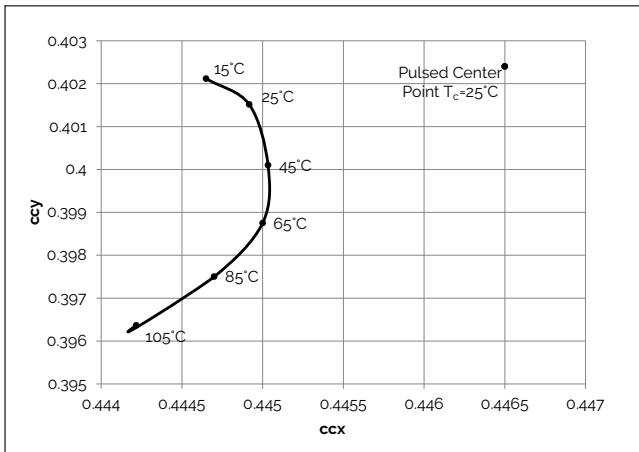

**Figure 13: 3000K Class A Color Shift vs. Case Temperature<sup>1</sup>**

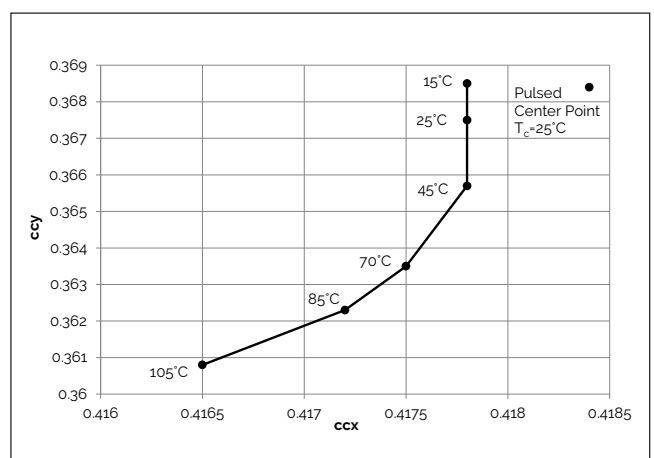

**Figure 14: 3500K Class A Color Shift vs. Case Temperature<sup>1</sup>**

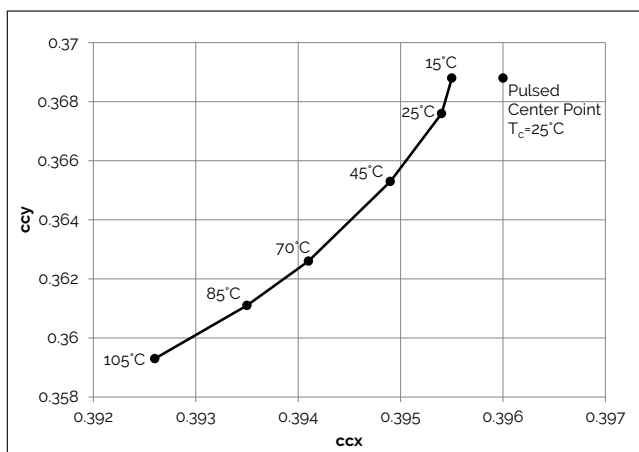

**Figure 15: 4000K Class A Color Shift vs. Case Temperature<sup>1</sup>**

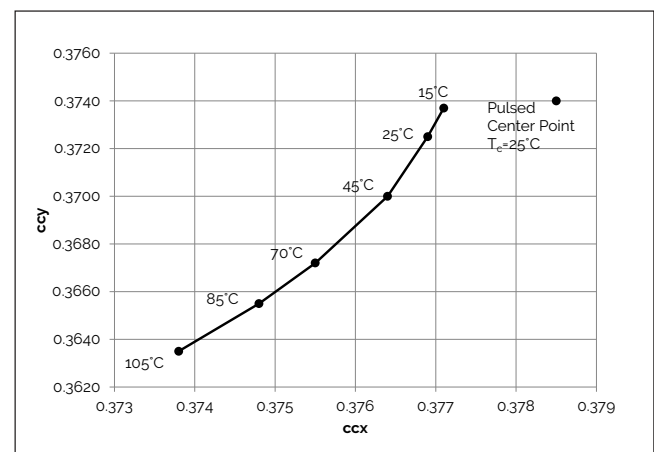

Notes for Figures 10-15:

1. Measurements made under DC test conditions at the nominal drive current.
2. Typical color shift is shown with a tolerance of  $\pm 0.002$ .
3. Characteristics shown for Decor Series Showcase products, BXRC-30G400C-x-73-SE

# Typical Radiation Pattern

Figure 16: Typical Spatial Radiation Pattern

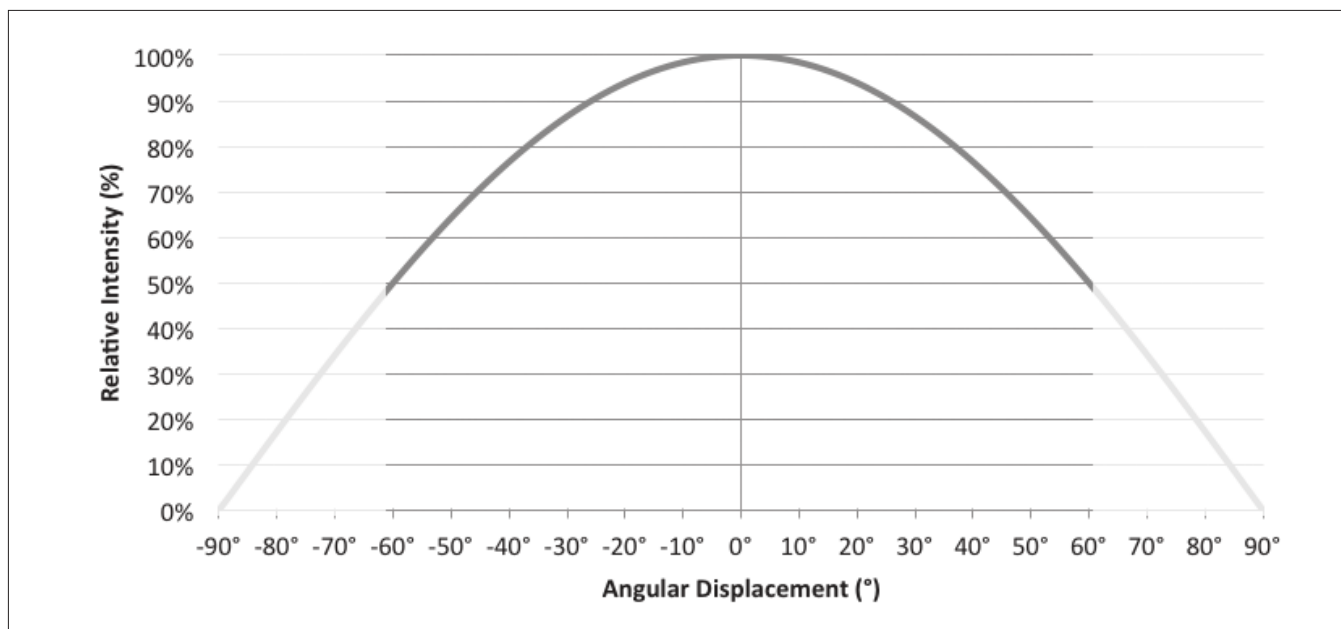

Note for Figure 16:

1. Typical viewing angle is 120°.
2. The viewing angle is defined as the off axis angle from the centerline where intensity is ½ of the peak value.

Figure 17: Typical Polar Radiation Pattern

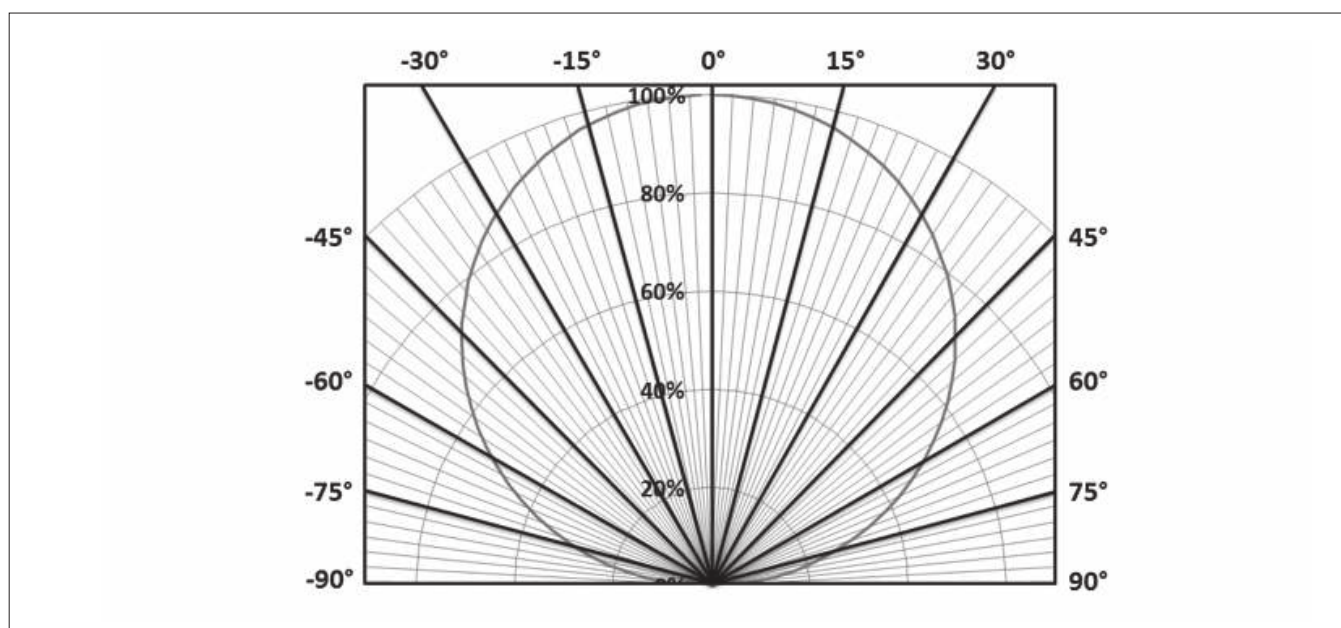

# Typical Color Spectrum

Figure 18: Typical Color Spectrum

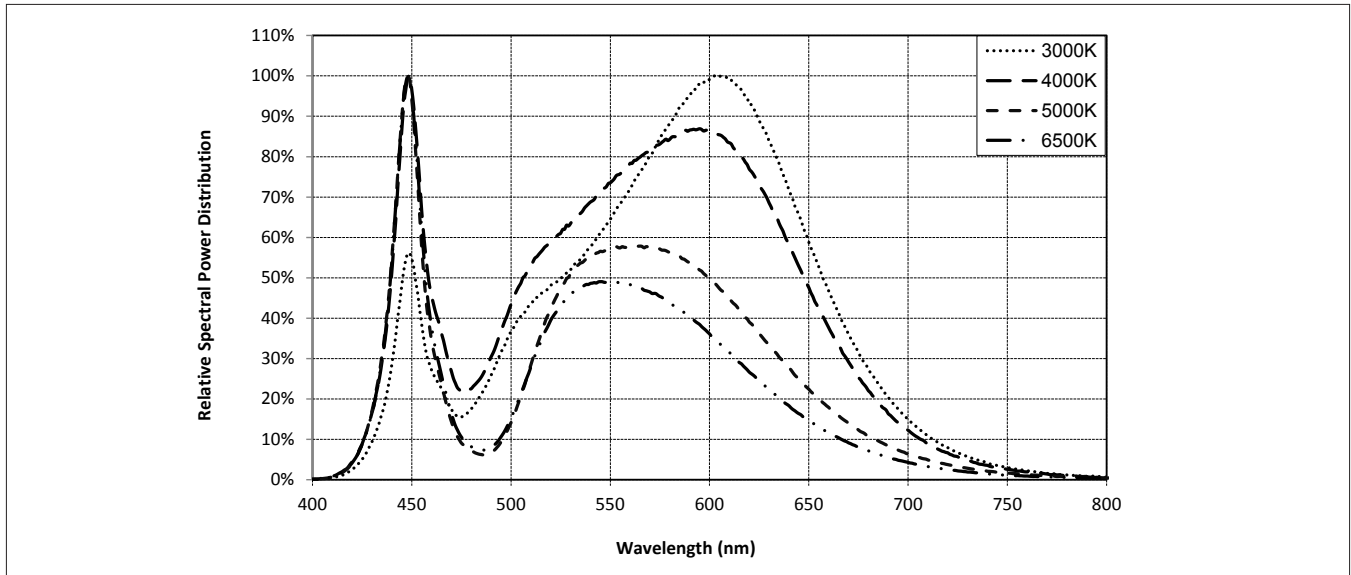

Note for Figure 18:

1. Color spectra measured at nominal current for  $T_j = T_c = 25^\circ\text{C}$ .
2. Color spectra shown is 3000K and 80 CRI.
3. Color spectra shown is 4000K and 80 CRI.
4. Color spectra shown is 5000K and 70 CRI.
4. Color spectra shown is 6500K and 70 CRI.

Figure 19: Typical Color Spectrum for Vero SE 13 with Décor Series

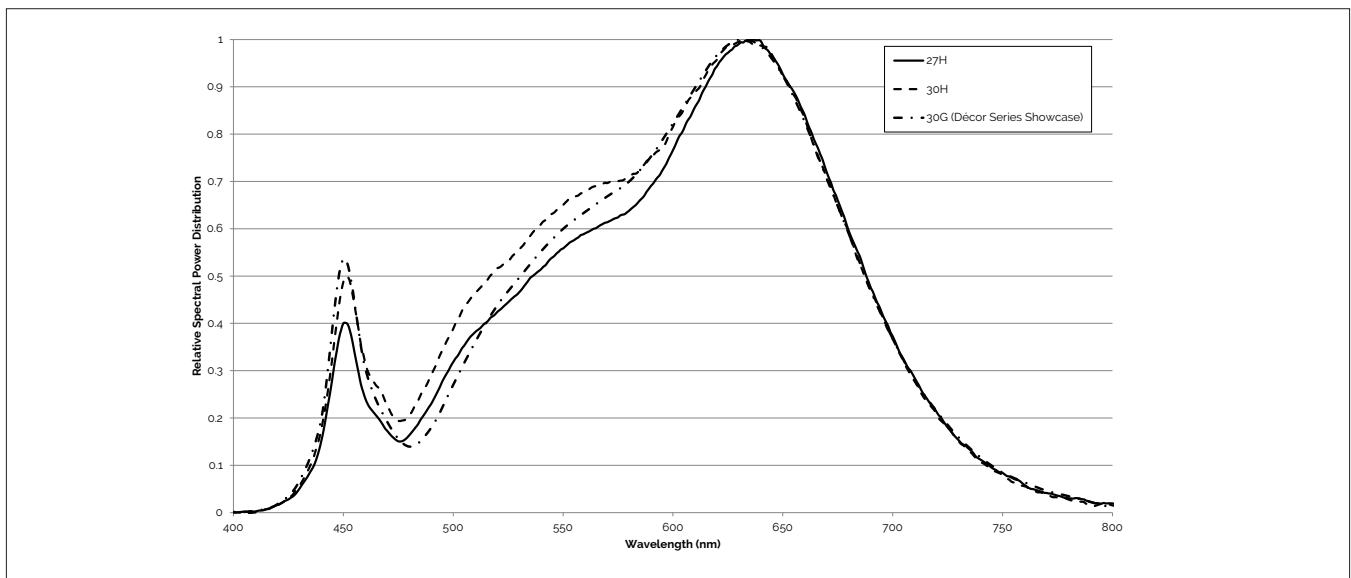

Note for Figure 19:

1. Color spectra measured at nominal current for  $T_j = T_c = 25^\circ\text{C}$ .

# Mechanical Dimensions

**Figure 20: Drawing for Vero SE 13 LED Array**

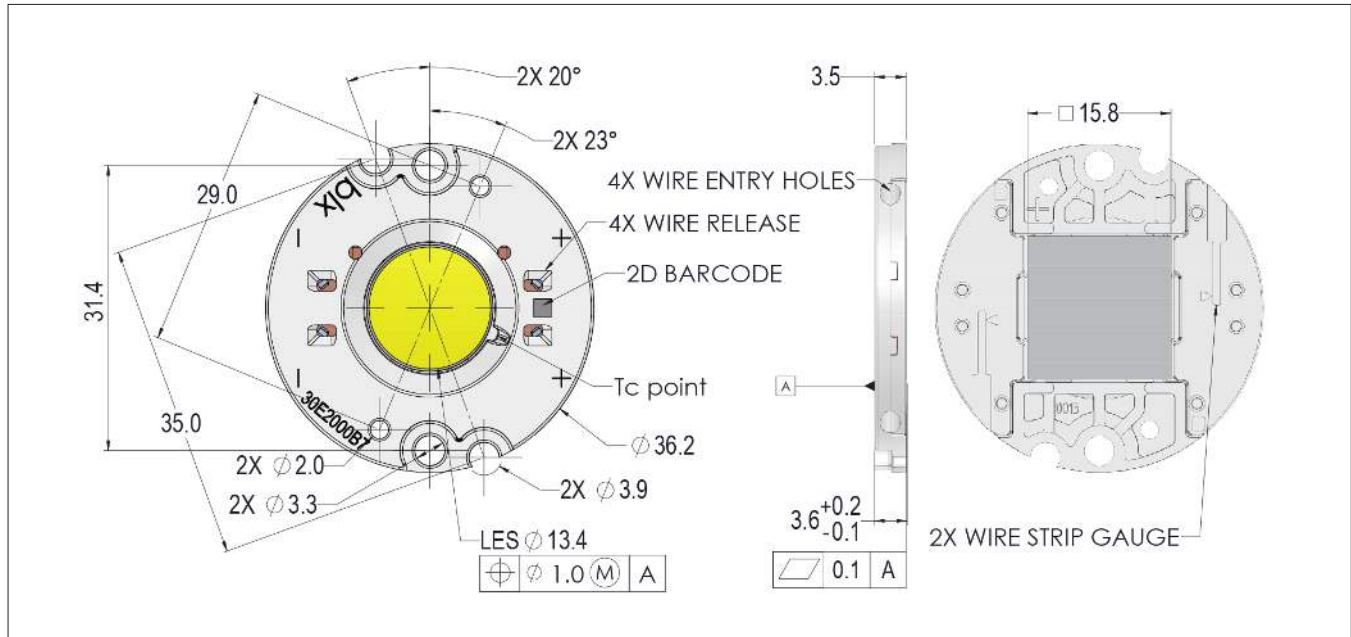

Notes for Figure 20:

1. Drawings are not to scale.
2. Drawing dimensions are in millimeters.
3. Unless otherwise specified, tolerances are  $\pm 0.1$ mm.
4. Mounting holes (2X) are for M3 screws.
5. Bridgelux recommends two tapped holes for mounting screws with  $31.4 \pm 0.10$ mm center-to-center spacing.
6. Screws with flat shoulders (pan, dome, button, round, truss, mushroom) provide optimal torque control. Do NOT use flat, countersink, or raised head screws.
7. The optical center of the LED Array is nominally defined by the mechanical center of the array to a tolerance of  $\pm 0.2$ mm.
8. Bridgelux maintains a flatness of 0.10mm across the mounting surface of the array.

# Color Binning Information

**Figure 21: Warm and Neutral White Test Bins in xy Color Space**

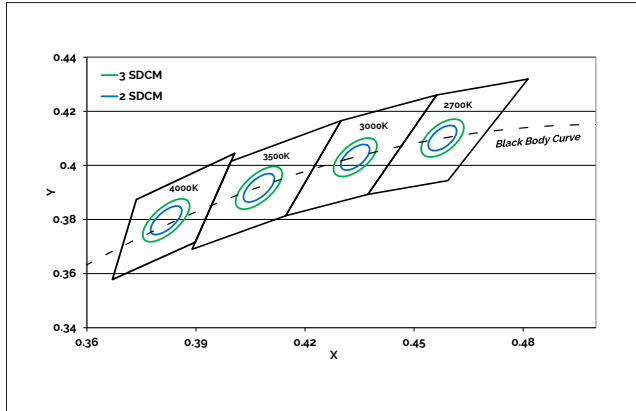

Note: Pulsed Test Conditions,  $T_c = 25^\circ\text{C}$

**Figure 22: Cool White Test Bins in xy Color Space**

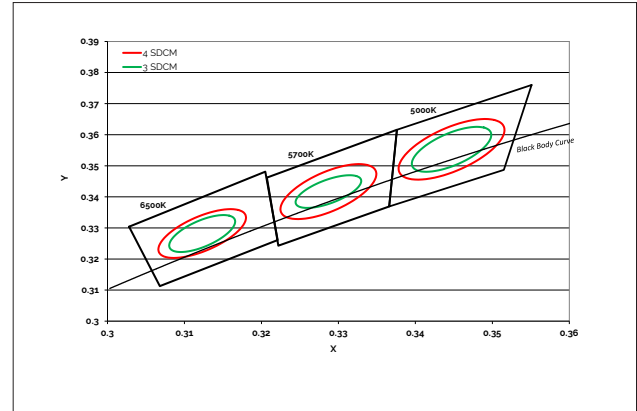

Note: Pulsed Test Conditions,  $T_c = 25^\circ\text{C}$

**Table 8: Warm and Neutral White xy Bin Coordinates and Associated Typical CCT**

Bin Code	2700K	3000K <sup>2</sup>	3500K <sup>1</sup>	4000K <sup>1</sup>
ANSI Bin (for reference only)	(2580K - 2870K)	(2870K - 3220K)	(3220K - 3710K)	(3710K - 4260K)
73 (3 SDCM)	(2651K - 2794K)	(2968K - 3136K)	(3369K - 3586K)	(3851K - 4130K)
72 (2 SDCM)	(2674K - 2769K)	(2995K - 3107K)	(3404K - 3548K)	(3895K - 4081K)
Center Point (x,y)	(0.4578, 0.4101)	(0.4338, 0.403) (0.4465, 0.4024) <sup>2</sup>	(0.4073, 0.3917)	(0.3818, 0.3797)

Note for Table 8:

1. Color Binning information excludes Decor Series Class A products. Please contact your Bridgelux Sales Representative for more information.
2. Center Point for Decor Series Showcase.

**Table 9: Cool White xy Bin Coordinates and Associated Typical CCT (product is hot targeted to  $T_c = 85^\circ\text{C}$ )**

Bin Code	5000K	5700K	6500K
ANSI Bin (for reference only)	(4745K - 5311K)	(5312K - 6022K)	(6022K - 7042K)
74 (4 SDCM)	(4801K - 5282K)	(5829K - 5481K)	(6270K - 6765K)
73 (3 SDCM)	(4835K - 5215K)	(5490K - 5820K)	(6250K - 6745K)
Center Point (x,y)	(0.3447, 0.3553)	(0.3287, 0.3417)	(0.3123, 0.3282)

# Packaging and Labeling

Figure 23: Drawing for Vero SE 13 Packaging Tray

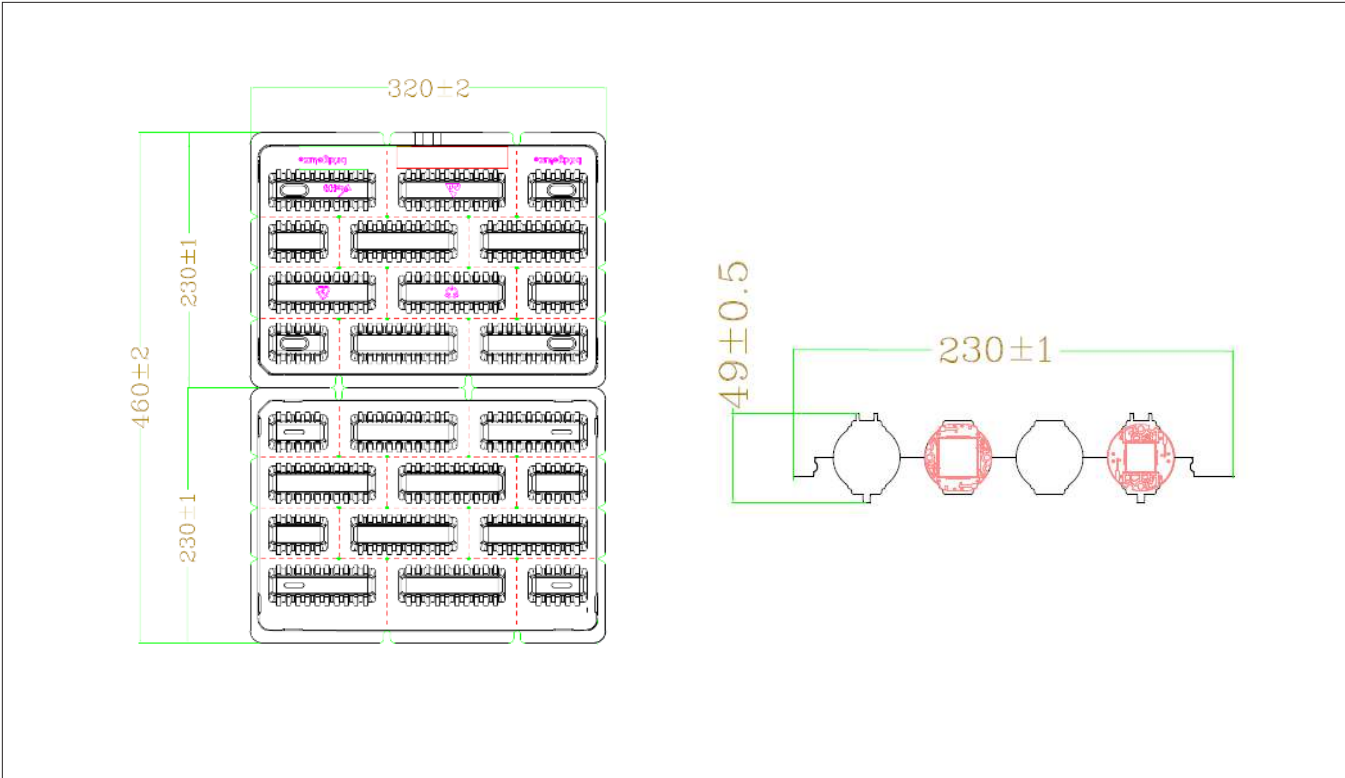

- Notes for Figure 23:
- 1. Dimensions are in millimeters.
  - 2. Drawings are not to scale.

# Packaging and Labeling

**Figure 24: Vero SE Series Packaging and Labeling**

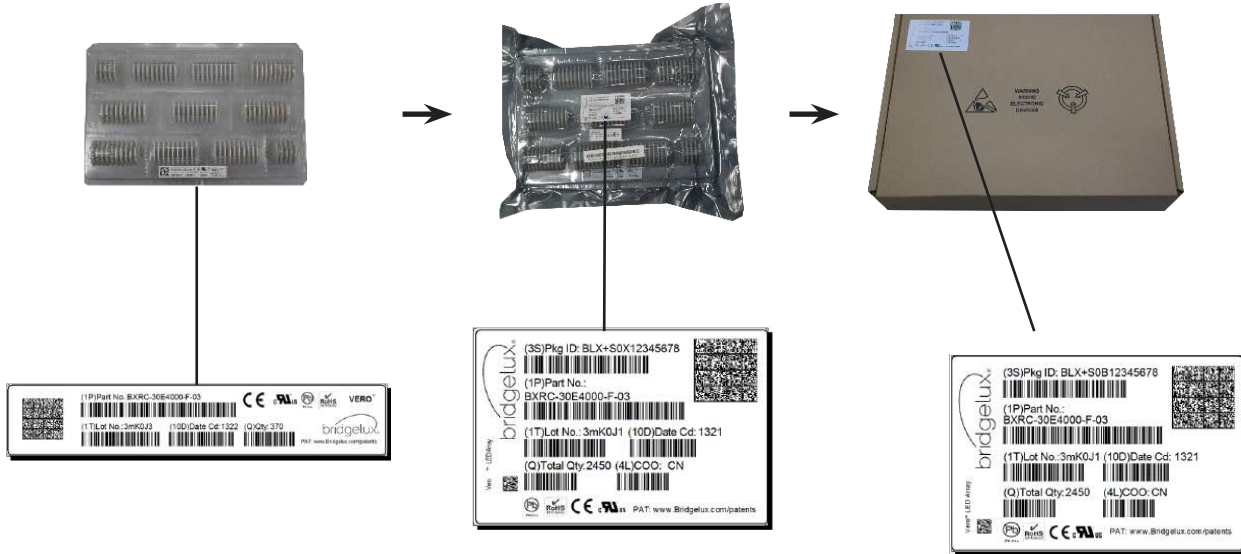

Notes for Figure 24:

1. Each tray holds 100 COBs.
2. Each tray is vacuum sealed in an anti-static bag and placed in its own box.
3. Each tray, bag and box is to be labeled as shown above.

**Figure 25: Vero SE Product Labeling**

Bridgelux COB arrays have laser markings on the back side of the substrate to help with product identification. In addition to the product identification markings, Bridgelux COB arrays also contain markings for internal Bridgelux manufacturing use only. The image below shows which markings are for customer use and which ones are for Bridgelux internal use only. The Bridgelux internal manufacturing markings are subject to change without notice, however these will not impact the form, function or performance of the COB array.



Customer Use- 2D Barcode  
Scannable barcode provides product part number and other Bridgelux internal production information.

Customer Use- Product part number

**30E2000C 73 2F**

Customer Use- V<sub>f</sub> Bin Code  
included to enable greater luminaire design flexibility. Refer to ANg2 for bin code definitions.



# Design Resources

## Application Notes

Bridgelux has developed a comprehensive set of application notes and design resources to assist customers in successfully designing with the Vero product family of LED array products. For all available application notes visit [www.bridgelux.com](http://www.bridgelux.com).

## Optical Source Models

Optical source models and ray set files are available for all Bridgelux products. For a list of available formats, visit [www.bridgelux.com](http://www.bridgelux.com).

## 3D CAD Models

Three dimensional CAD models depicting the product outline of all Bridgelux Vero LED arrays are available in both IGS and STEP formats. Please contact your Bridgelux sales representative for assistance.

## LM80

LM80 testing has been completed and the LM80 report is now available. Please contact your Bridgelux sales representative for LM-80 report.

# Precautions

## CAUTION: CHEMICAL EXPOSURE HAZARD

Exposure to some chemicals commonly used in luminaire manufacturing and assembly can cause damage to the LED array. Please consult Bridgelux Application Note AN121 for additional information.

## CAUTION: RISK OF BURN

Do not touch the Vero LED array during operation. Allow the array to cool for a sufficient period of time before handling. The Vero LED array may reach elevated temperatures such that could burn skin when touched.

## CAUTION

### CONTACT WITH LIGHT EMITTING SURFACE (LES)

Avoid any contact with the LES. Do not touch the LES of the LED array or apply stress to the LES (yellow phosphor resin area). Contact may cause damage to the LED array.

Optics and reflectors must not be mounted in contact with the LES (yellow phosphor resin area). Optical devices may be mounted on the top surface of the plastic housing of the Vero LED array. Use the mechanical features of the LED array housing, edges and/or mounting holes to locate and secure optical devices as needed.

# Disclaimers

## MINOR PRODUCT CHANGE POLICY

The rigorous qualification testing on products offered by Bridgelux provides performance assurance. Slight cosmetic changes that do not affect form, fit, or function may occur as Bridgelux continues product optimization.

## STANDARD TEST CONDITIONS

Unless otherwise stated, array testing is performed at the nominal drive current.

# About Bridgelux: Bridging Light and Life™

At Bridgelux, we help companies, industries and people experience the power and possibility of light. Since 2002, we've designed LED solutions that are high performing, energy efficient, cost effective and easy to integrate. Our focus is on light's impact on human behavior, delivering products that create better environments, experiences and returns—both experiential and financial. And our patented technology drives new platforms for commercial and industrial luminaires.

**For more information about the company, please visit**  
**bridgelux.com**  
**twitter.com/Bridgelux**  
**facebook.com/Bridgelux**  
**youtube.com/user/Bridgelux**  
**linkedin.com/company/bridgelux-inc-\_2**  
**WeChat ID: BridgeluxInChina**



46430 Fremont Boulevard  
Fremont, CA 94538 U.S.A.  
Tel (925) 583-8400  
**www.bridgelux.com**

© 2016-2018 Bridgelux, Inc. All rights reserved 2018. Product specifications are subject to change without notice. Bridgelux, the Bridgelux stylized logo design, Vero, V Series and V Series HD are registered trademarks, and Decor Series is a trademark of Bridgelux, Inc. All other trademarks are the property of their respective owners.

**Bridgelux Vero SE 13 Array Series Product Data Sheet DS121 Rev. K (10/2018)**