

PT2424

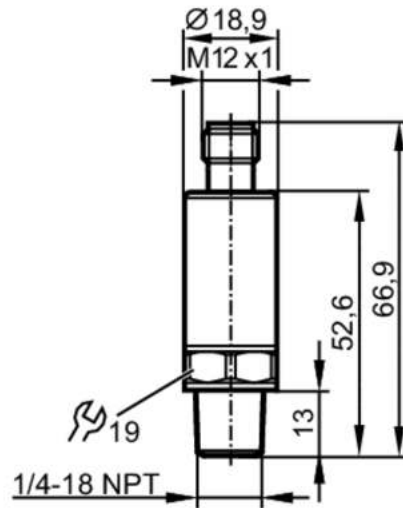

Pressure transmitter

PT-020PSEN14-A-ZVG/US/ IW



Product characteristics

Number of inputs and outputs	Number of analogue outputs: 1
Measuring range [psi]	0...200
Process connection	threaded connection 1/4" NPT external thread

Application

Application	for industrial applications
Media	liquids and gases
Medium temperature [°C]	-40...90
Min. bursting pressure [psi]	6525
Pressure rating [psi]	580
Note on pressure rating	static
Vacuum resistance [psi]	-14.5
Type of pressure	relative pressure
MAWP (for applications according to CRN) [psi]	580

Electrical data

Operating voltage [V]	8.5...36 DC
Min. insulation resistance [MΩ]	100; (500 V DC)
Protection class	III
Reverse polarity protection	yes
Power-on delay time [s]	< 0.1

Inputs / outputs

Number of inputs and outputs	Number of analogue outputs: 1
------------------------------	-------------------------------

Outputs

Total number of outputs	1
Output signal	analogue signal

PT2424



Pressure transmitter

PT-020PSEN14-A-ZVG/US/ IW

Number of analogue outputs	1
Analogue current output [mA]	4...20
Max. load [Ω]	$(U_b - 8,5 \text{ V}) / 21,5 \text{ mA}$; @8,5V= 0 Ω ; @12V max. 160 Ω ; @24V max. 720 Ω
Short-circuit proof	yes
Overload protection	yes

Measuring/setting range

Measuring range [psi]	0...200
-----------------------	---------

Accuracy / deviations

Repeatability [% of the span]	$< \pm 0,05$; (with temperature fluctuations $< 10 \text{ K}$)
Characteristics deviation [% of the span]	$< \pm 0,5$; (incl. drift when overtightened, zero point and span error, non-linearity, hysteresis)
Linearity deviation [% of the span]	$< \pm 0,1$ (BFSL) / $< \pm 0,2$ (LS)
Hysteresis deviation [% of the span]	$< \pm 0,2$
Long-term stability [% of the span]	$< \pm 0,1$; (per 6 months)
Temperature coefficient zero point and span [% of the span / 10 K]	$< 0,1$ (-25...90 $^{\circ}\text{C}$) / $< 0,2$ (-40...-25 $^{\circ}\text{C}$)

Response times

Step response time analogue output [ms]	1
---	---

Operating conditions

Ambient temperature [$^{\circ}\text{C}$]	-40...90
Storage temperature [$^{\circ}\text{C}$]	-40...100
Protection	IP 67; IP 69K

Tests / approvals

EMC	DIN EN 61000-6-2	
	DIN EN 61000-6-3	
Shock resistance	DIN EN 60068-2-27	50 g (11 ms)
Vibration resistance	DIN EN 60068-2-6	20 g (10...2000 Hz)
MTTF [years]		784
Pressure Equipment Directive	Sound engineering practice; can be used for group 2 fluids; group 1 fluids on request	

Mechanical data

Weight [g]	57.5
Materials	1.4542 (17-4 PH / 630); stainless steel (1.4404 / 316L); PEI
Materials (wetted parts)	1.4542 (17-4 PH / 630)
Min. pressure cycles	60 million; (at 1.2 times nominal pressure)
Tightening torque [Nm]	< 50 ; (recommended tightening torque; depends on lubrication, seal and pressure rating)
Process connection	threaded connection 1/4" NPT external thread
Restrictor element integrated	no (can be retrofitted)

Remarks

Remarks	BFSL = Best Fit Straight Line LS = limit value setting
---------	---

PT2424



Pressure transmitter

PT-020PSEN14-A-ZVG/US/ IW

Pack quantity

1 pcs.

Electrical connection

Connector: 1 x M12; coding: A



Connection

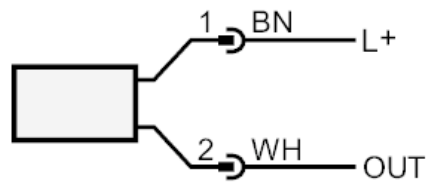

OUT analogue output
 colours to DIN EN 60947-5-2
 Core colours :
BN = brown
WH = white