

**Features**

- Low power consumption
- Robust package
- I.C. Compatible
- Standard configuration: Gray face w/ white segments
- Optional black face provides superior color contrast
- RoHS Compliant

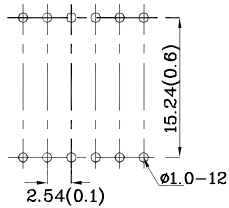

**RECOMMENDED PCB LAYOUT**



**Package Schematics**

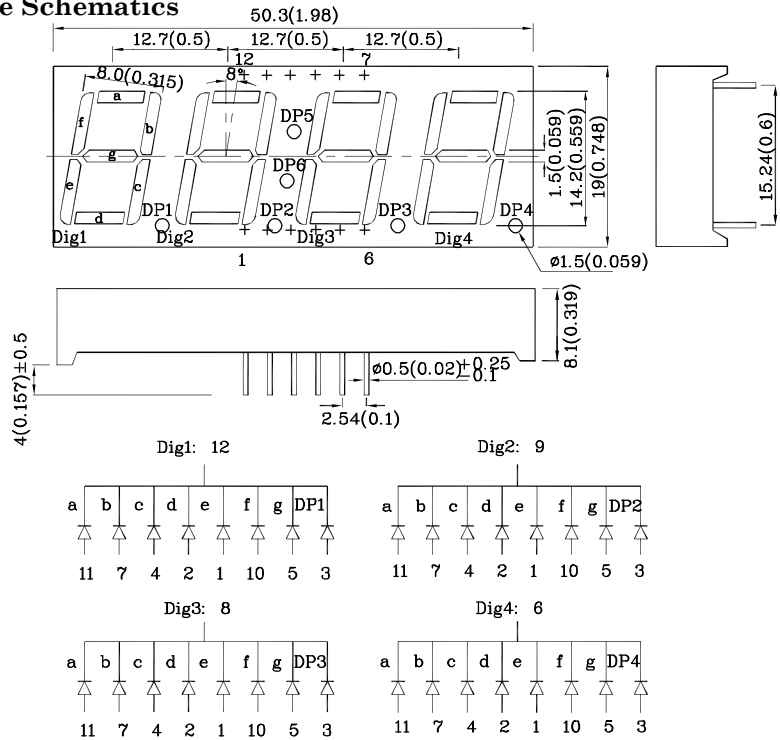

**Notes:**

1. All dimensions are in millimeters (inches), Tolerance is ±0.25(0.01") unless otherwise noted.
2. Specifications are subject to change without notice.

Absolute Maximum Ratings (T <sub>A</sub> =25°C)		UG (GaP)	Unit
Reverse Voltage	V <sub>R</sub>	5	V
Forward Current	I <sub>F</sub>	25	mA
Forward Current (Peak) 1/10 Duty Cycle 0.1ms Pulse Width	i <sub>FS</sub>	140	mA
Power Dissipation	P <sub>D</sub>	62.5	mW
Operating Temperature	T <sub>A</sub>	-40 ~ +85	°C
Storage Temperature	T <sub>stg</sub>	-40 ~ +85	
Lead Solder Temperature [2mm Below Package Base]	260°C For 3-5 Seconds		

Operating Characteristics (T <sub>A</sub> =25°C)		UG (GaP)	Unit
Forward Voltage (Typ.) (I <sub>F</sub> =10mA)	V <sub>F</sub>	2	V
Forward Voltage (Max.) (I <sub>F</sub> =10mA)	V <sub>F</sub>	2.5	V
Reverse Current (Max.) (V <sub>R</sub> =5V)	I <sub>R</sub>	10	uA
Wavelength of Peak Emission CIE127-2007* (Typ.) (I <sub>F</sub> =10mA)	λ <sub>P</sub>	565*	nm
Wavelength of Dominant Emission CIE127-2007* (Typ.) (I <sub>F</sub> =10mA)	λ <sub>D</sub>	568*	nm
Spectral Line Full Width At Half-Maximum (Typ.) (I <sub>F</sub> =10mA)	Δλ	30	nm
Capacitance (Typ.) (V <sub>F</sub> =0V, f=1MHz)	C	15	pF

Part Number	Emitting Color	Emitting Material	Luminous Intensity CIE127-2007* (I <sub>F</sub> =10mA) ucd		Wavelength CIE127-2007* nm λ <sub>P</sub>	Description
			min.	typ.		
XDUG14C4-A	Green	GaP	5600 2200*	10990 4490*	565*	Common Cathode, Rt.Hand Decimal.

\*Luminous intensity value and wavelength are in accordance with CIE127-2007 standards.

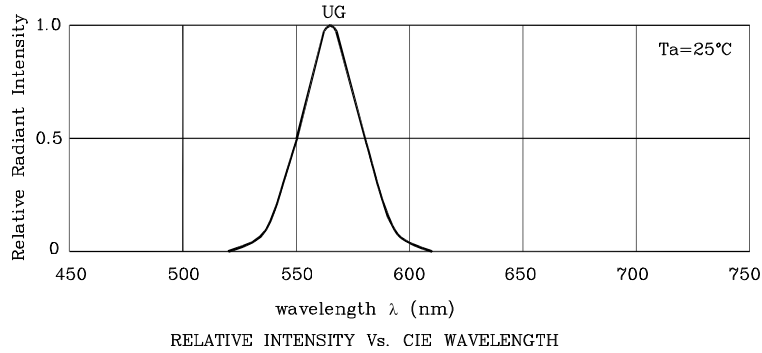

❖ UG

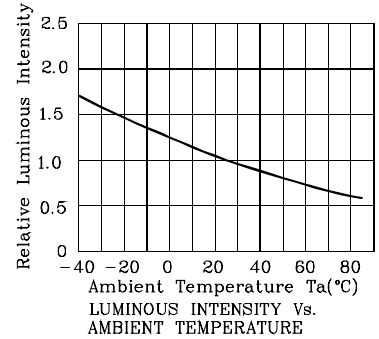
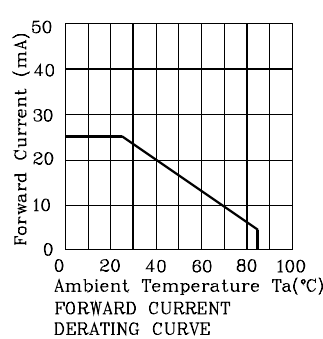
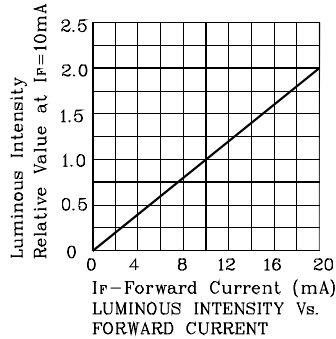
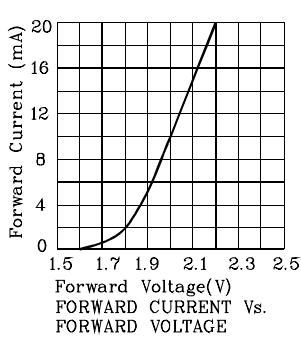

Wave Soldering Profile for Thru-Hole Products (Pb-Free Components)

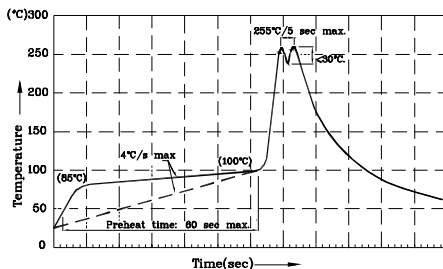

- Notes:
- 1.Recommend pre-heat temperature of 105°C or less (as measured with a thermocouple attached to the LED pins) prior to immersion in the solder wave with a maximum solder bath temperature of 260°C
  - 2.Peak wave soldering temperature between 245°C ~ 255°C for 3 sec (5 sec max).
  - 3.Do not apply stress to the epoxy resin while the temperature is above 85°C.
  - 4.Fixtures should not incur stress on the component when mounting and during soldering process.
  - 5.SAC 305 solder alloy is recommended.
  - 6.No more than one wave soldering pass.

Remarks:

If special sorting is required (e.g. binning based on forward voltage, luminous intensity / luminous flux, or wavelength), the typical accuracy of the sorting process is as follows:

1. Wavelength: +/-1nm
2. Luminous Intensity / Luminous Flux: +/-15%
3. Forward Voltage: +/-0.1V

Note: Accuracy may depend on the sorting parameters.

PACKING & LABEL SPECIFICATIONS

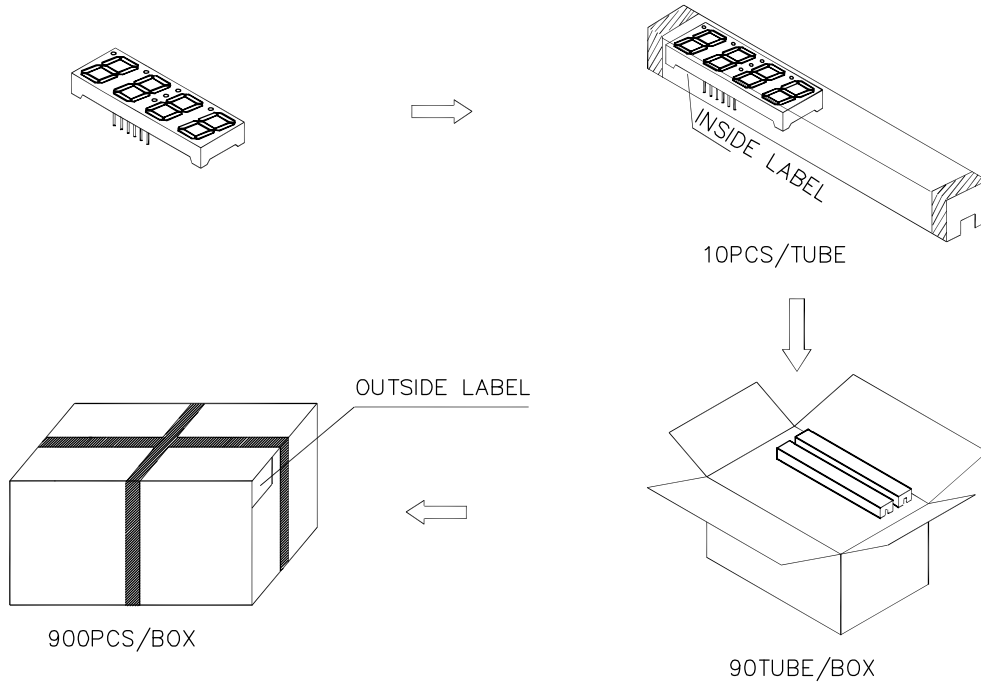

Inside Label On IC-tube

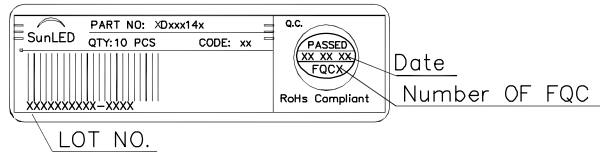

Outside Label On Box

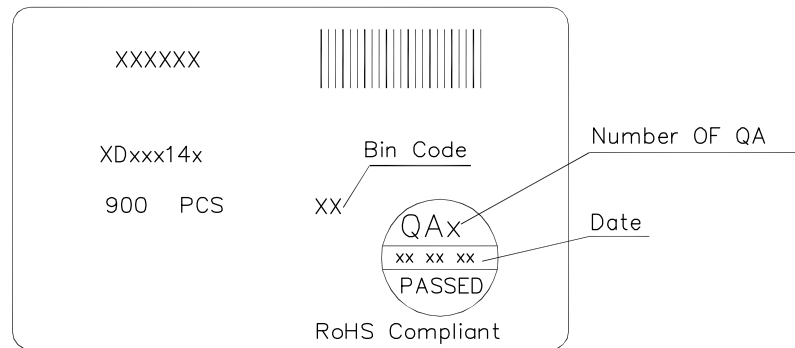

TERMS OF USE

1. Data presented in this document reflect statistical figures and should be treated as technical reference only.
2. Contents within this document are subject to improvement and enhancement changes without notice.
3. The product(s) in this document are designed to be operated within the electrical and environmental specifications indicated on the datasheet. User accepts full risk and responsibility when operating the product(s) beyond their intended specifications.
4. The product(s) described in this document are intended for electronic applications in which a person's life is not reliant upon the LED. Please consult with a SunLED representative for special applications where the LED may have a direct impact on a person's life.
5. The contents within this document may not be altered without prior consent by SunLED.
6. Additional technical notes are available at <http://www.SunLEDusa.com/TechnicalNotes.asp>