

Mono 1W Speaker and Stereo 160mW Headset BTL Drivers with Digital Volume Control

- Operating from $V_{CC} = 3V$ to 5.5V
- Rail to rail input/output
- Speaker driver with 1 W output @ $V_{CC} = 5V$, THD+N = 1%, F = 1kHz, 8Ω load
- Headset drivers with 160 mW output @ $V_{CC} = 5V$, THD+N = 1%, F = 1kHz, 32Ω load
- Headset output is 30mW in stereo @ $V_{CC} = 3V$
- THD+N < 0.5% Max @ 20mW into 32Ω BTL, 50Hz < Frequency < 20kHz
- 32-step digital volume control from -34.5dB to +12dB
- +6dB power up volume and full standby
- 8 different output modes
- Pop & click reduction circuitry
- Low shutdown current (< 100nA)
- Thermal shutdown protection
- Flip-chip package 18 x 300μm bumps

Description

The TS4851 is a low power audio amplifier that can drive either both a mono speaker or a stereo headset. To the speaker, it can deliver 400 mW (typ.) of continuous RMS output power into an 8Ω load with a 1% THD+N value. To the headset driver, the amplifier can deliver 30 mW (typ.) per channel of continuous average power into a stereo 32 Ω bridged-tied load with 0.5% THD+N @ 3.3V.

This device features a 32-step digital volume control and 8 different output selections. The digital volume and output modes are controlled through a three-digit SPI interface bus.

Applications

- Mobile Phones

Order Codes

Part Number	Temperature Range	Package	Packaging	Marking
TS4851IJT	-40, +85°C	Flip-Chip	Tape & Reel	A51
TS4851EIJT		Lead free Flip-Chip		A51

J = Flip Chip Package - only available in Tape & Reel (JT)

Pin Connections (top view)

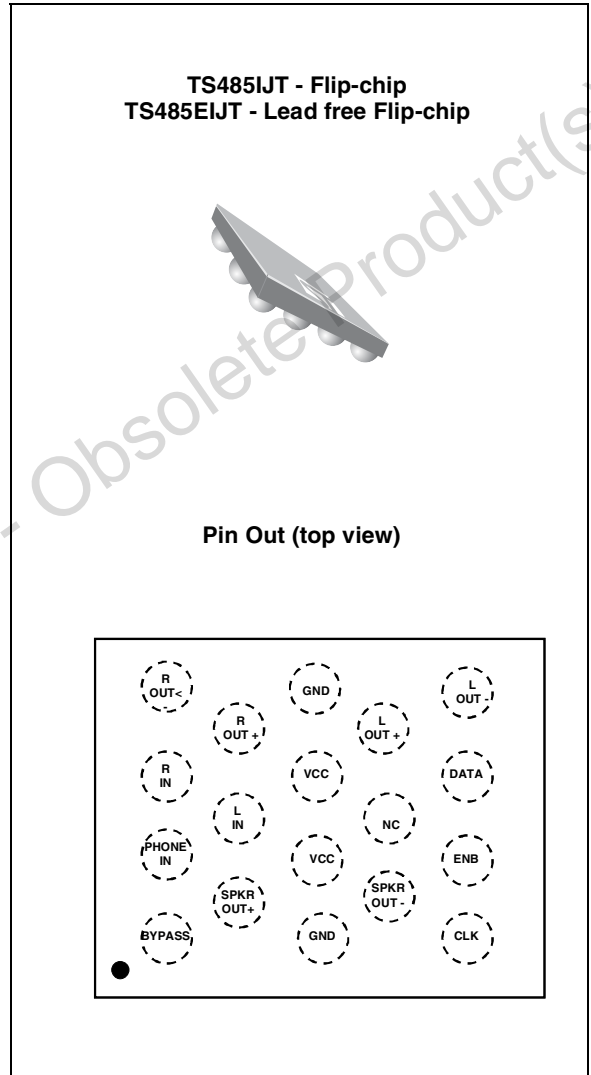

1 Application Information

Figure 1: Application information for a typical application

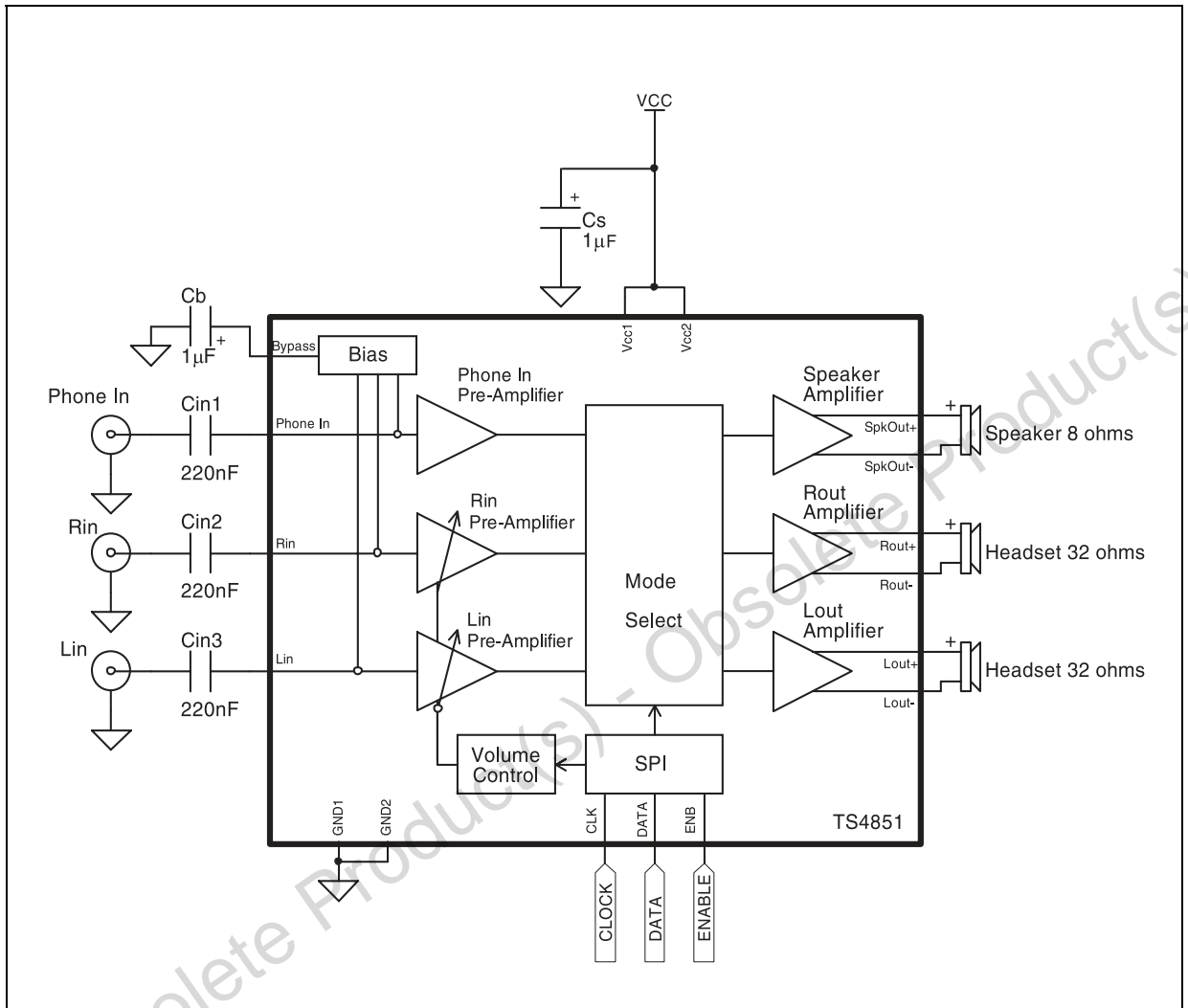

Table 1. External component description

Component	Functional Description
C_{in}	This is the input coupling capacitor. It blocks the DC voltage at, and couples the input signal to the amplifier's input terminals. C_{in} also creates a highpass filter with the internal input impedance Z_{in} at $F_c = 1 / (2\pi i \times Z_{in} \times C_{in})$.
C_s	This is the Supply Bypass capacitor. It provides power supply filtering.
C_B	This is the Bypass pin capacitor. It provides half-supply filtering.

2 SPI Bus Interface

Table 2. Pin description

Pin	Functional Description
DATA	This is the serial data input pin.
CLK	This is the clock input pin.
ENB	This is the SPI enable pin active at high level.

2.1 Description of SPI operation

The serial data bits are organized into a field containing 8 bits of data as shown in [Table 3](#). The DATA 0 to DATA 2 bits determine the output mode of the TS4851 as shown in [Table 2](#). The DATA 3 to DATA 7 bits determine the gain level setting as illustrated by [Table 3](#). For each SPI transfer, the data bits are written to the DATA pin with the least significant bit (LSB) first. All serial data are sampled at the rising edge of the CLK signal. Once all the data bits have been sampled, ENB transitions from logic-high to logic low to complete the SPI sequence. All 8 bits must be received before any data latch can occur. Any excess CLK and DATA transitions will be ignored after the height rising clock edge has occurred. For any data sequence longer than 8 bits, only the first 8 bits will get loaded into the shift register and the rest of the bits will be disregarded.

Table 3. Bit allocation

	DATA	MODES
LSB	DATA 0	Mode 1
	DATA 1	Mode 2
	DATA 2	Mode 3
	DATA 3	gain 1
	DATA 4	gain 2
	DATA 5	gain 3
	DATA 6	gain 4
MSB	DATA 7	gain 5

Table 4. Output mode selection: G from -34.5dB to +12dB (by steps of 1.5dB)

Output Mode #	DATA 2	DATA 1	DATA 0	SPKERout ¹	Rout	Lout
0	0	0	0	SD	SD	SD
1	0	0	1	6dBxP	SD	SD
2	0	1	0	SD	0dBxP	0dBxP
3	0	1	1	Gx(R+L)	SD	SD
4	1	0	0	SD	GxR	GxL
5	1	0	1	Gx(R+L) +6dBxP	SD	SD
6	1	1	0	SD	GxR+0dBxP	GxL+0dBxP
7	1	1	1	6dBxP	GxR+0dBxP	GxL+0dBxP

1) SD = Shutdown Mode, P = Phone in Input, R = Rin input and L = Lin input

Table 5. Volume control settings

K : Gain (dB)	DATA 7	DATA 6	DATA 5	DATA 4	DATA 3
-34.5	0	0	0	0	0
-33.0	0	0	0	0	1
-31.5	0	0	0	1	0
-30.0	0	0	0	1	1
-28.5	0	0	1	0	0
-27.0	0	0	1	0	1
-25.5	0	0	1	1	0
-24.0	0	0	1	1	1
-22.5	0	1	0	0	0
-21.0	0	1	0	0	1
-19.5	0	1	0	1	0
-18.0	0	1	0	1	1
-16.5	0	1	1	0	0
-15.0	0	1	1	0	1
-13.5	0	1	1	1	0
-12.0	0	1	1	1	1
-10.5	1	0	0	0	0
-9.0	1	0	0	0	1
-7.5	1	0	0	1	0
-6.0	1	0	0	1	1
-4.5	1	0	1	0	0
-3.0	1	0	1	0	1
-1.5	1	0	1	1	0
0.0	1	0	1	1	1
1.5	1	1	0	0	0
3.0	1	1	0	0	1
4.5	1	1	0	1	0
6	1	1	0	1	1
7.5	1	1	1	0	0
9	1	1	1	0	1
10.5	1	1	1	1	0
12	1	1	1	1	1

Figure 2: SPI timing diagram

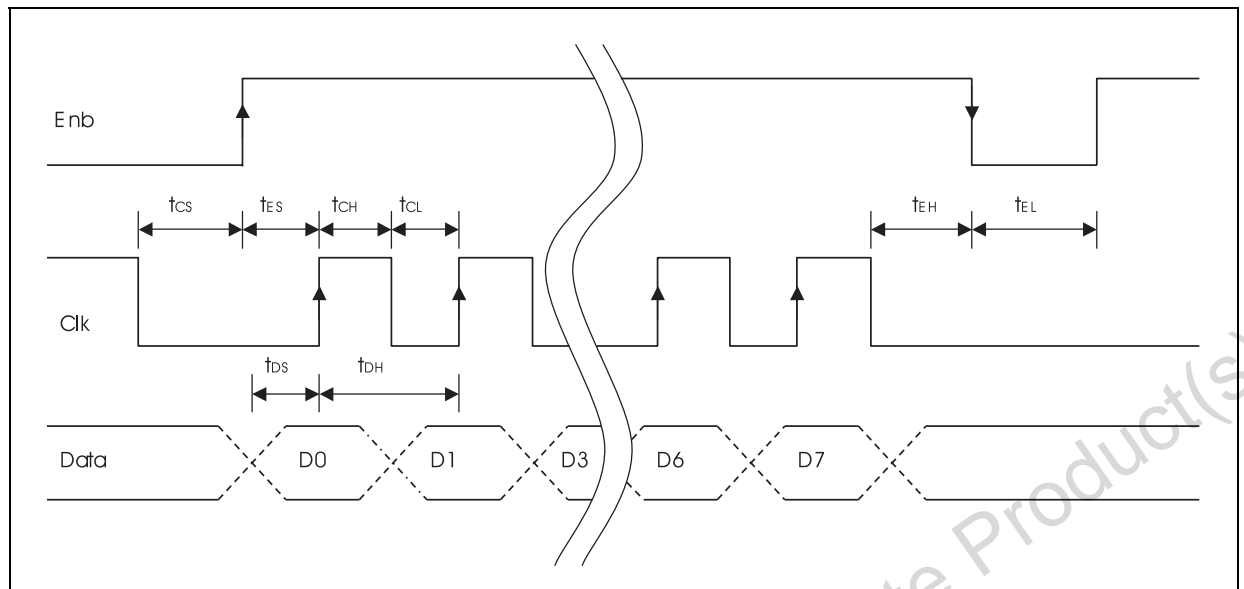

3 Absolute Maximum Ratings

Table 6. Key parameters and their absolute maximum ratings

Symbol	Parameter	Value	Unit
VCC	Supply voltage ¹	6	V
T _{oper}	Operating Free Air Temperature Range	-40 to + 85	°C
T _{stg}	Storage Temperature	-65 to +150	°C
T _j	Maximum Junction Temperature	150	°C
R _{thja}	Flip Chip Thermal Resistance Junction to Ambient ²	200	°C/W
P _d	Power Dissipation	Internally Limited	
ESD	Human Body Model	2	kV
ESD	Machine Model	100	V
	Latch-up Immunity	200	mA
	Lead Temperature (soldering, 10sec)	250	°C
	Lead Temperature (soldering, 10sec) for Lead-Free version	260	

- 1) All voltages values are measured with respect to the ground pin.
- 2) Device is protected in case of over temperature by a thermal shutdown active @ 150°C

Table 7. Operating conditions

Symbol	Parameter	Value	Unit
VCC	Supply Voltage	3 to 5.5	V
V _{phin}	Maximum Phone In Input Voltage	G _{ND} to V _{CC}	V
VRin/VLin	Maximum Rin & Lin Input Voltage	G _{ND} to V _{CC}	V
TSD	Thermal Shut Down Temperature	150	°C
R _{thja}	Flip Chip Thermal Resistance Junction to Ambient ¹	90	°C/W

- 1) Device is protected in case of over temperature by a thermal shutdown active @ 150°C

4 Electrical Characteristics

Table 8. Electrical characteristics at VCC = +5V, GND = 0V, Tamb = 25°C (unless otherwise specified)

Symbol	Parameter	Min.	Typ.	Max.	Unit
I _{CC}	Supply Current				mA
	Output Mode 7, Vin = 0V, no load		8	11	
	All other output modes, Vin = 0V, no load		4.5	6.5	
I _{STANDBY}	Standby Current Output Mode 0		0.1	2	μA
V _{oo}	Output Offset Voltage (differential) Vin = 0V		5	50	mV
V _{il}	"Logic low" input Voltage	0		0.4	V
V _{ih}	"Logic high" input Voltage	1.4		5	V
P _o	Output Power				mW
	SPKERout, RL = 8Ω, THD = 1%, F = 1kHz	800	1000		
	Rout & Lout, RL = 32Ω, THD = 0.5%, F = 1kHz	80	120		
THD + N	Total Harmonic Distortion + Noise				%
	Rout & Lout, Po = 80mW, F = 1kHz, RL = 32Ω			0.5	
	SPKERout, Po = 800mW, F = 1kHz, RL = 8Ω			1	
	Rout & Lout, Po = 50mW, 20Hz < F < 20kHz, RL = 32Ω		0.5		
	SPKERout, Po = 40mW, 20Hz < F < 20kHz, RL = 8Ω		1		
SNR	Signal To Noise Ratio (A-Weighted)		90		dB
PSRR	Power Supply Rejection Ratio ¹				dB
	Vripple = 200mV Vpp, F = 217Hz, Input(s) Terminated 10Ω				
	Output Mode 1		70		
	Output Mode 2		70		
	Output Mode 3 (G=+12dB)		55		
	Output Mode 4 (G=+12dB)		57		
	Output Mode 5 (G=+12dB)		52		
Output Mode 6, 7 (G=+12dB)		56			
G	Digital Gain Range - Rin & Lin no load	-34.5		+12	dB
	Digital gain stepsize		1.5		
	Stepsize				
	G ≥ -22.5dB	-0.5		+0.5	dB
	G < -22.5dB	-1		+1	
	Phone In Gain, no load				dB
	BTL gain from Phone In to SPKERout		6		
	BTL gain from Phone In to Rout & Lout		0		
Z _{in}	Phone In Input Impedance	15	20	25	kΩ
Z _{in}	Rin & Lin Input Impedance (all gain setting)	37.5	50	62.5	kΩ
tes	Enable Stepup Time - ENB	20			ns
teh	Enable Hold Time - ENB	20			ns
tel	Enable Low Time - ENB	30			ns
tds	Data Setup Time- DATA	20			ns
tdh	Data Hold Time - DATA	20			ns
tcs	Clock Setup time - CLK	20			ns
tch	Clock Logic High Time - CLK	50			ns
tcl	Clock Logic Low Time - CLK	50			ns
fclk	Clock Frequency - CLK	DC		10	MHz

1) Dynamic measurements [20 x log(rms(Vout)/rms(Vripple))]. Vripple is the superimposed sinus signal to Vcc @ F = 217Hz

Table 9. Electrical characteristics at VCC = +3V, GND = 0V, Tamb = 25°C (unless otherwise specified)

Symbol	Parameter	Min.	Typ.	Max.	Unit
I _{CC}	Supply Current Output Mode 7, Vin = 0V, no load All other output modes, Vin = 0V, no load		7.5 4.5	10 6.5	mA
I _{STANDBY}	Standby Current Output Mode 0		0.1	2	μA
V _{oo}	Output Offset Voltage (differential) Vin = 0V		5	50	mV
V _{il}	"Logic low" input Voltage	0		0.4	V
V _{ih}	"Logic high" input Voltage	1.4		5	V
P _o	Output Power SPKERout, RL = 8Ω, THD = 1%, F = 1kHz Rout & Lout, RL = 32Ω, THD = 0.5%, F = 1kHz	300 20	340 30		mW
THD + N	Total Harmonic Distortion + Noise Rout & Lout, Po = 20mW, F = 1kHz, RL = 32Ω SPKERout, Po = 300mW, F = 1kHz, RL = 8Ω Rout & Lout, Po = 15mW, 20Hz < F < 20kHz, RL = 32Ω SPKERout, Po = 250mW, 20Hz < F < 20kHz, RL = 8Ω			0.5 1	%
SNR	Signal To Noise Ratio (A-Weighted)		86		dB
PSRR ¹	Power Supply Rejection Ratio ² Vripple = 200mV Vpp, F = 217Hz, Input(s) Terminated 10Ω Output Mode 1 Output Mode 2 Output Mode 3 (G=+12dB) Output Mode 4 (G=+12dB) Output Mode 5 (G=+12dB) Output Mode 6, 7 (G=+12dB)				dB
G	Digital Gain Range - Rin & Lin no load	-34.5	-	+12	dB
	Digital gain stepsize		1.5		dB
	Stepsize error G ≥ -22.5dB G < -22.5dB	-0.5 -1		+0.5 +1	dB
	Phone In Gain, no load BTL gain from Phone In to SPKERout BTL gain from Phone In to Rout & Lout		6 0		dB
Z _{in}	Phone In Input Impedance ¹	15	20	25	kΩ
Z _{in}	Rin & Lin Input Impedance (All Gain Setting) ¹	37.5	50	62.5	kΩ
tes	Enable Setup Time - ENB	20			ns
teh	Enable Hold Time - ENB	20			ns
tel	Enable Low Time - ENB	30			ns
tds	Data Setup Time - DATA	20			ns
tdh	Data Hold Time - DATA	20			ns
tcs	Clock Setup time - CLK	20			ns
tch	Clock Logic High Time - CLK	50			ns
tcl	Clock Logic Low Time - CLK	50			ns
fclk	Clock Frequency - CLK	DC		10	MHz

1) All PSRR data limits are guaranteed by evaluation design test.

2) Dynamic measurements [20 x log(rms(Vout)/rms(Vripple))]. Vripple is the superimposed sinus signal to Vcc @ F = 217Hz

Table 10. Index of graphics

Description	Figure	Page
THD + N vs. Output Power	Figures 3 to 12	page 10 to page 11
THD + N vs. Frequency	Figures 13 to 22	page 11 to page 13
Output Power vs. Power Supply Voltage	Figures 23 to 30	page 13 to page 14
PSRR vs. Frequency	Figures 31 to 40	page 14 to page 16
Frequency Response	Figures 41 to 44	page 16
Signal to Noise Ratio vs. Power Supply Voltage	Figures 45 to 48	page 17
Crosstalk vs. Frequency	Figures 49 to 50	page 18
-3 dB Lower Cut Off Frequency vs. Input Capacitor	Figures 51 to 52	page 18
Current Consumption vs. Power Supply Voltage	Figure 53	page 18
Power Dissipation vs. Output Power	Figures 54 to 57	page 18 to page 19
Power Derating Curves	Figure 58	page 19
-3 dB Lower Cut Off Frequency vs. Gain Setting	Figure 59	page 19

Note: In the graphs that follow, the abbreviations Spkout = Speaker Output, and HDout = Headphone Output are used. All measurements made with $C_{in} = 220\text{nF}$, $C_b = C_s = 1\mu\text{F}$ except in PSRR condition where $C_s = 0$.

Figure 3: Spkout THD+N vs. output power (output modes 1, 7)

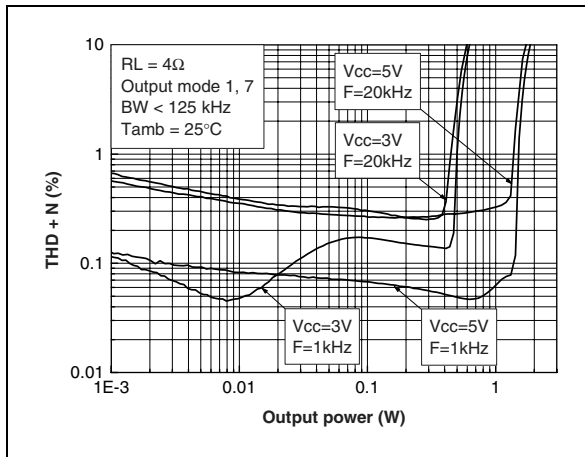

Figure 6: HDout THD+N vs. output power (output mode 2)

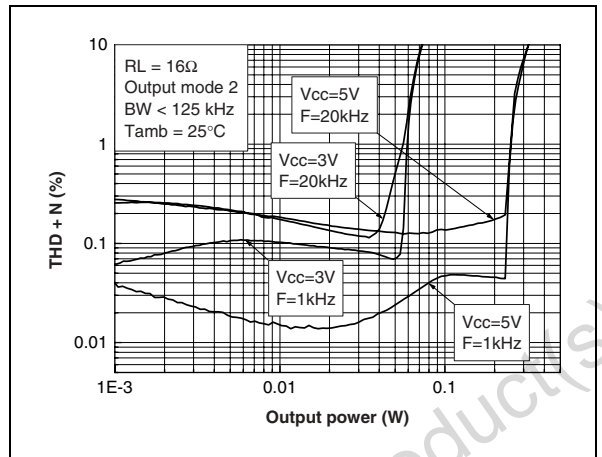

Figure 4: Spkout THD+N vs. output power (output modes 1, 7)

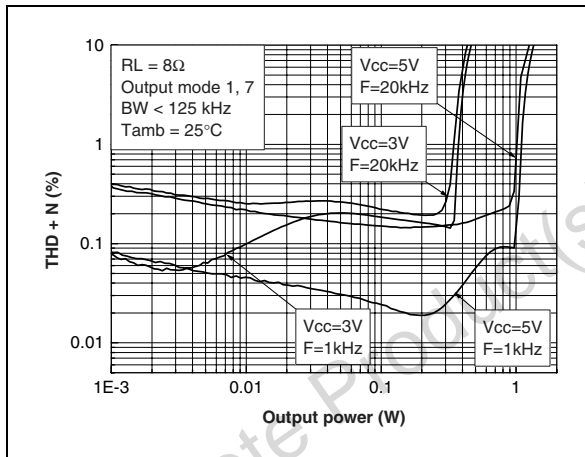

Figure 7: HDout THD+N vs. output power (output mode 2)

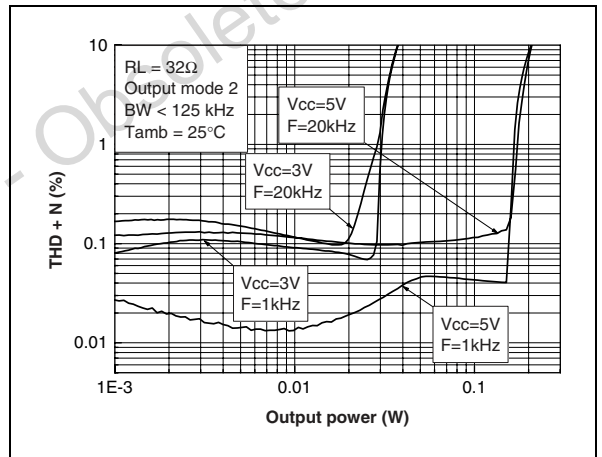

Figure 5: Spkout THD+N vs. output power (output modes 1, 7)

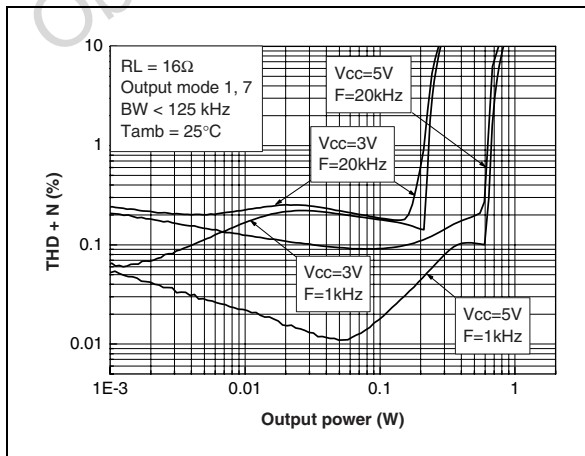

Figure 8: Spkout THD+N vs. output power (output mode 3, G=+12dB)

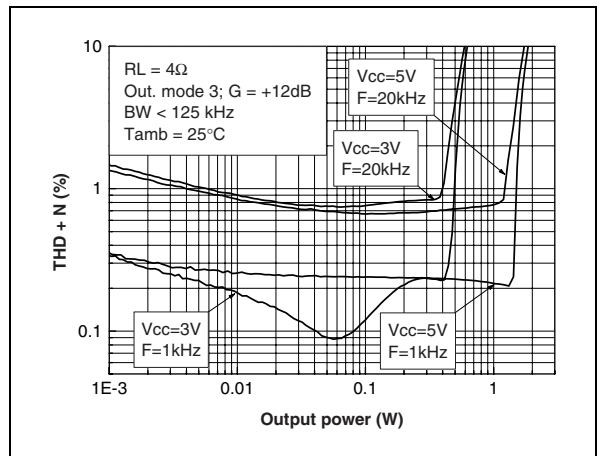

Figure 9: Spkout THD+N vs. output power (output mode 3, G=+12dB)

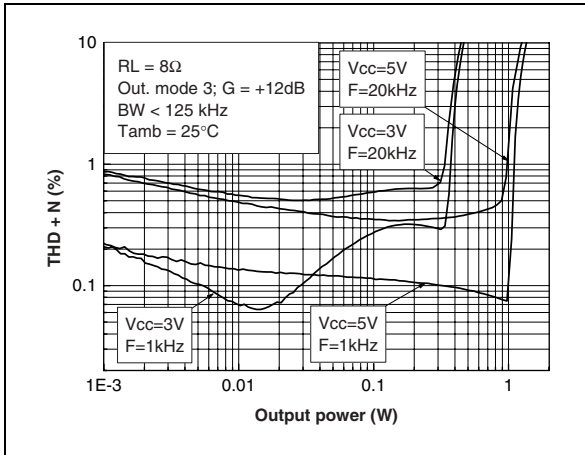

Figure 12: HDout THD+N vs. output power (output mode 4, G=+12dB)

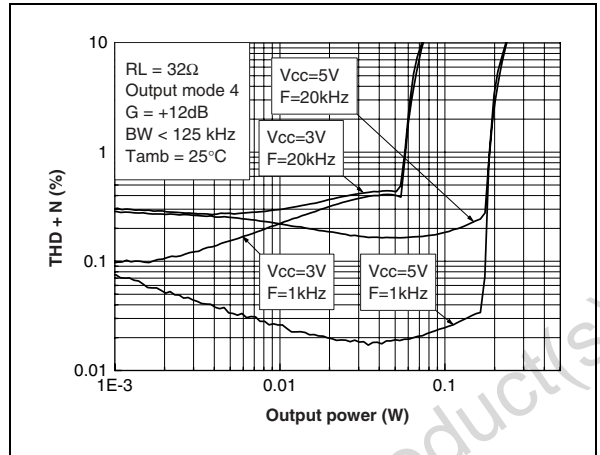

Figure 10: Spkout THD+N vs. output power (output mode 3, G=+12dB)

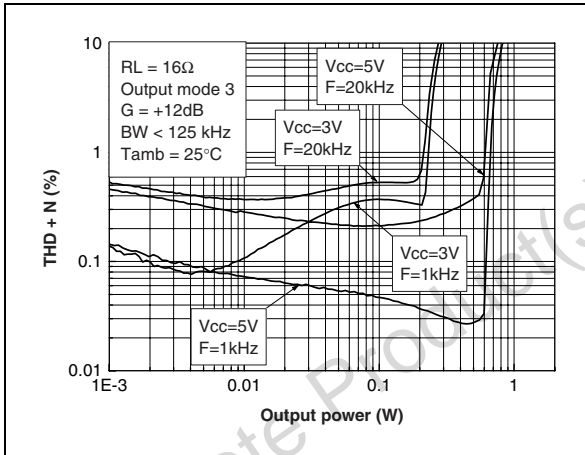

Figure 13: Spkout THD+N vs. frequency (output modes 1, 7)

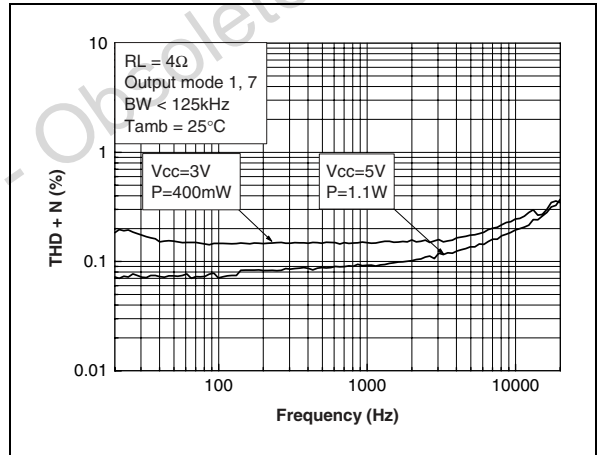

Figure 11: HDout THD+N vs. output power (output mode 4, G=+12dB)

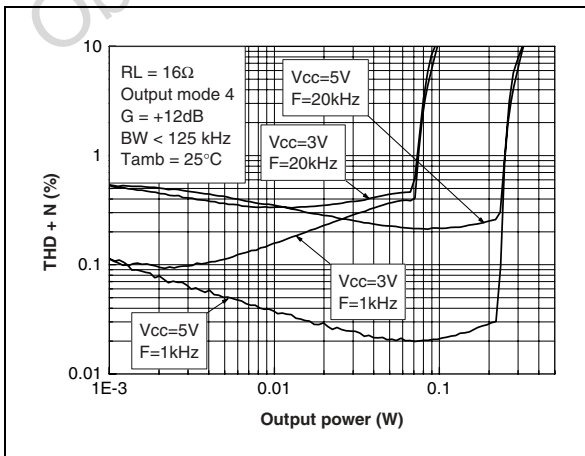

Figure 14: Spkout THD+N vs. frequency (output modes 1, 7)

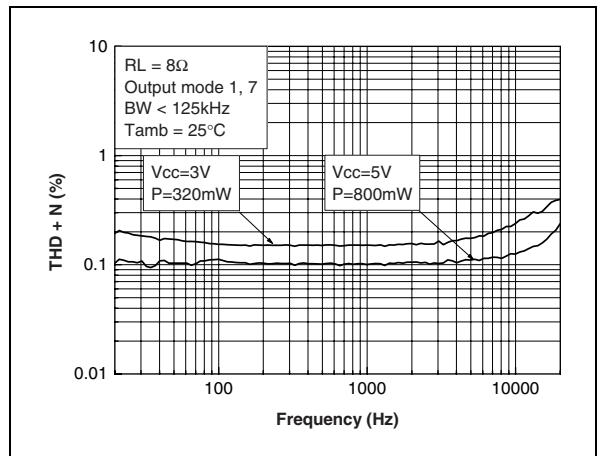

Figure 15: Spkout THD+N vs. frequency (output modes 1, 7)

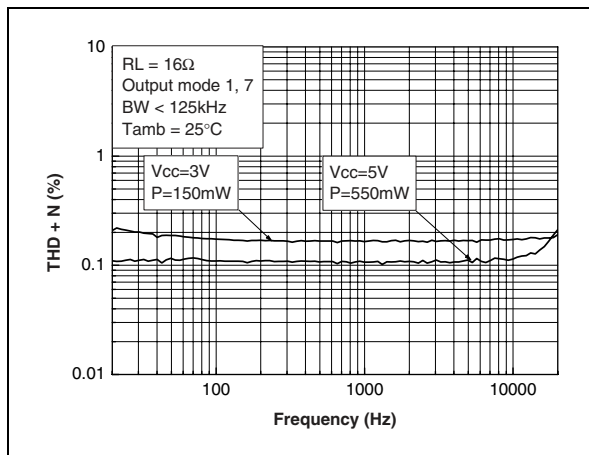

Figure 18: Spkout THD+N vs. frequency (output mode 3, G = +12 dB)

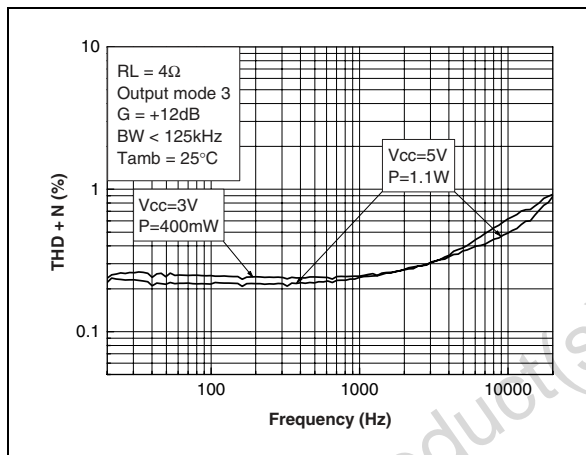

Figure 16: HDout THD+N vs. frequency (output mode 2)

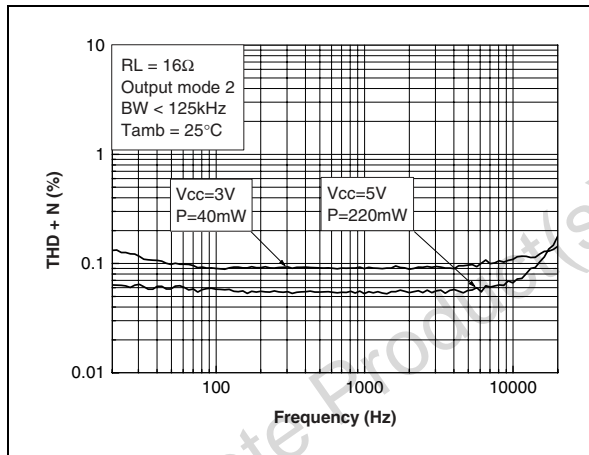

Figure 19: Spkout THD+N vs. frequency (output mode 3, G = +12 dB)

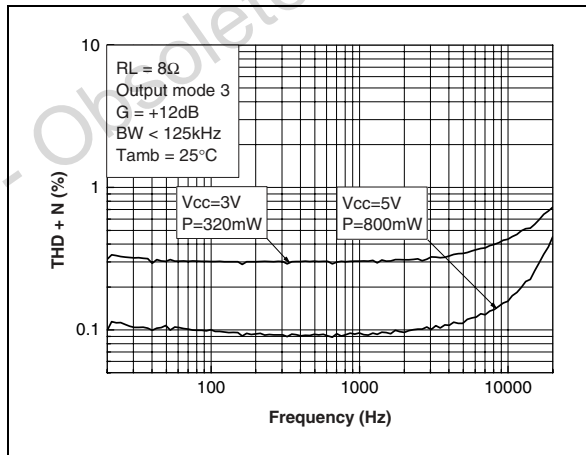

Figure 17: HDout THD+N vs. frequency (output mode 2)

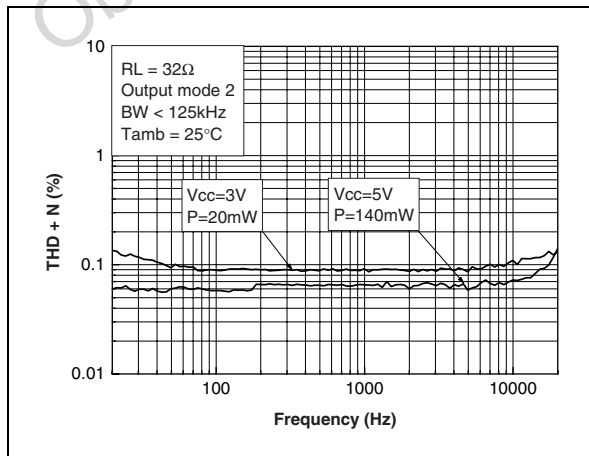

Figure 20: Spkout THD+N vs. frequency (output mode 3, G = +12 dB)

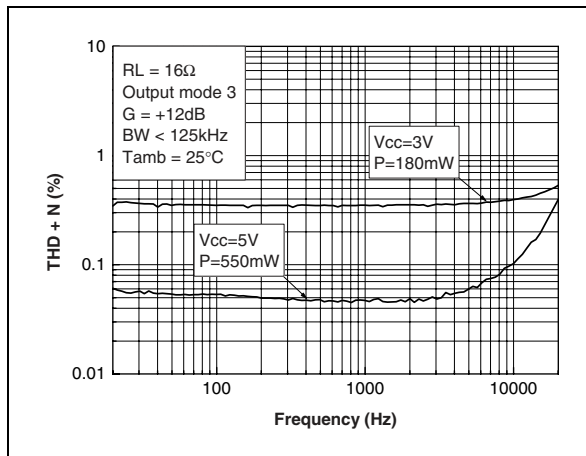

Figure 21: HDout THD+N vs. frequency (output mode 4, G = +12 dB)

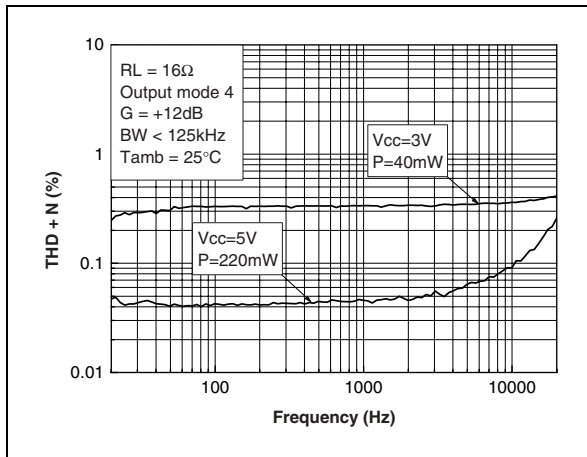

Figure 24: Speaker output power vs. power supply voltage (output mode 1, 7)

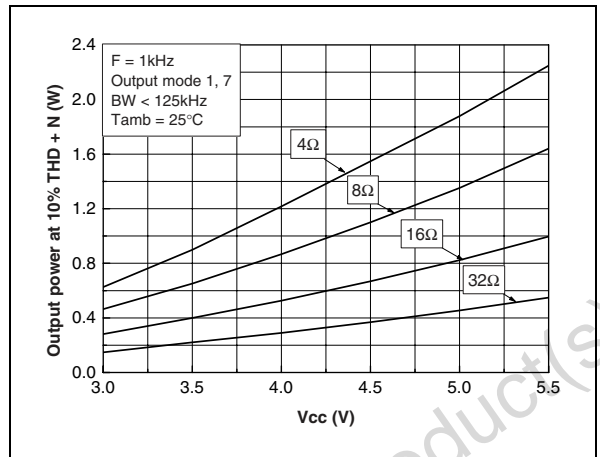

Figure 22: HDout THD+N vs. frequency (output mode 4, G = +12 dB)

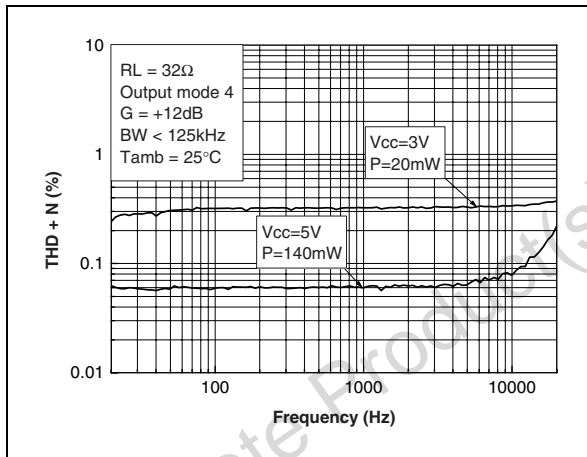

Figure 25: Headphone output power vs. load resistor (output mode 2)

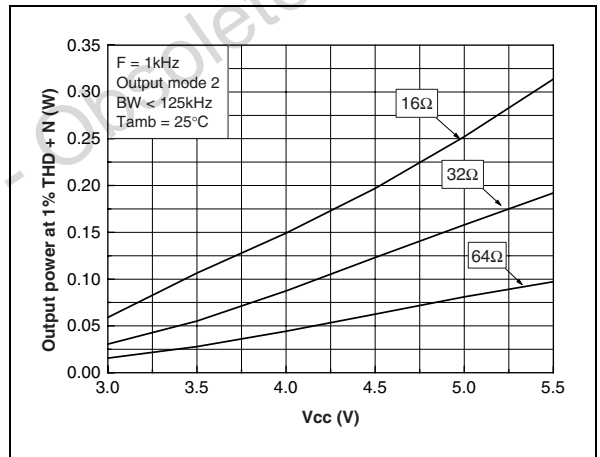

Figure 23: Speaker output power vs. power supply voltage (output mode 1, 7)

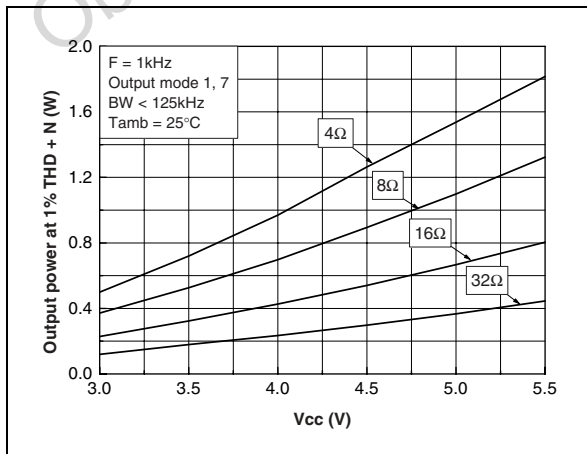

Figure 26: Headphone output power vs. load resistor (output mode 2)

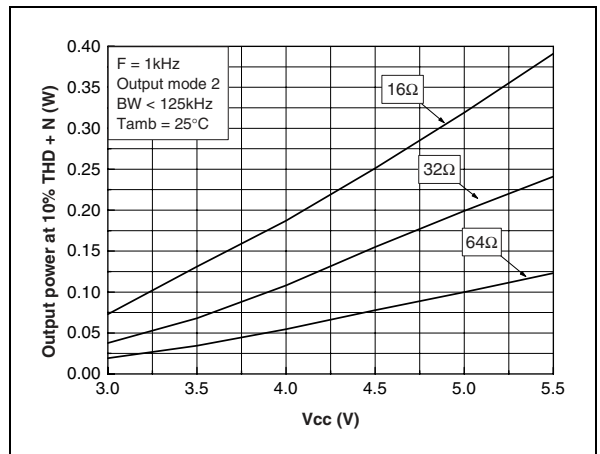

Figure 27: Speaker output power vs. power supply voltage (output mode 3)

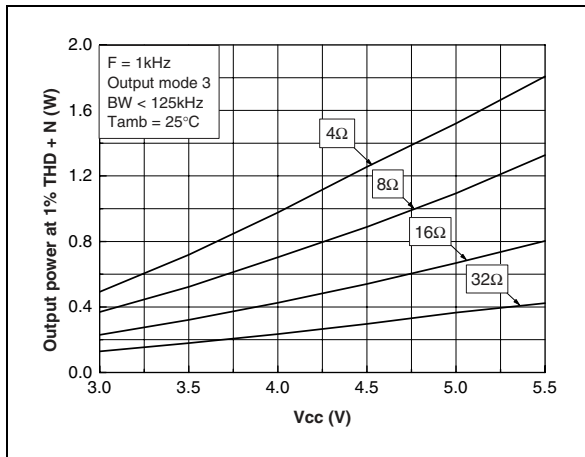

Figure 30: Headphone output power vs. load resistance (output mode 2)

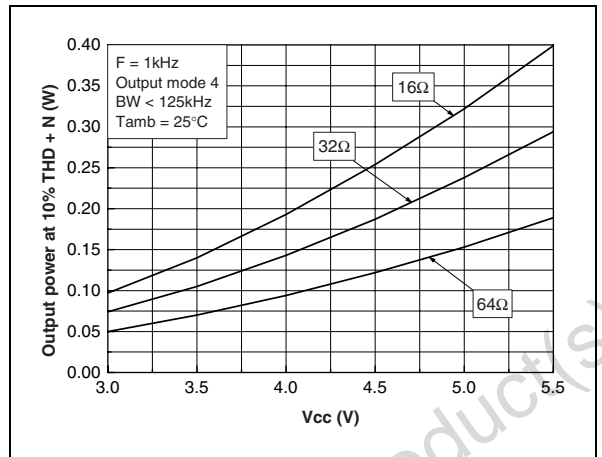

Figure 28: Speaker output power vs. power supply voltage (output mode 3)

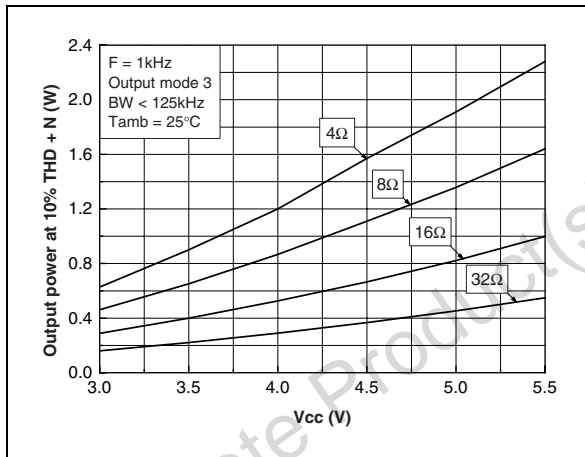

Figure 31: Spkout PSRR vs. frequency (output modes 1, 7, input grounded)

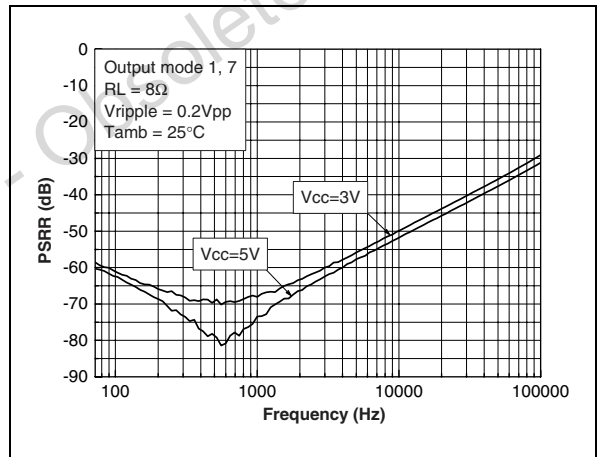

Figure 29: Headphone output power vs. load resistor (output mode 4)

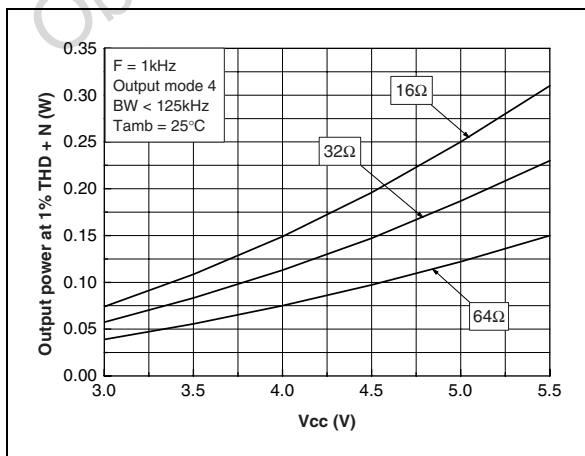

Figure 32: HDout PSRR vs. frequency (output mode 2, input grounded)

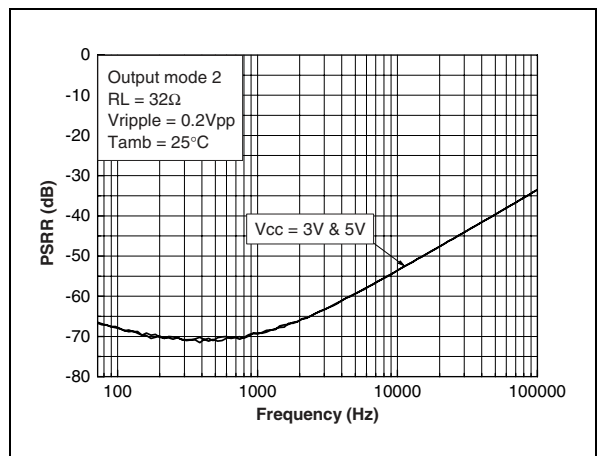

Figure 33: Spkout PSRR vs. frequency
(output mode 3, inputs grounded)

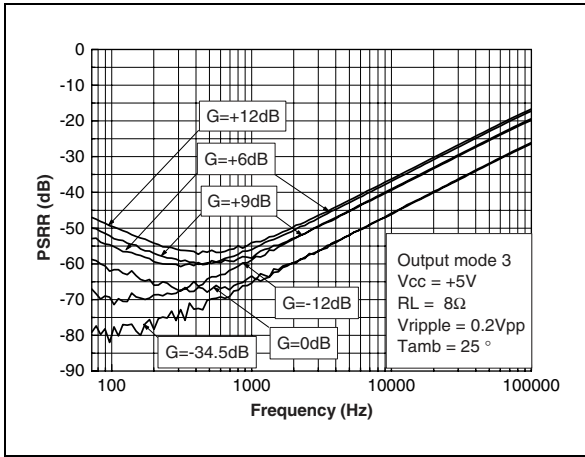

Figure 34: Spkout PSRR vs. frequency
(output mode 3, inputs grounded)

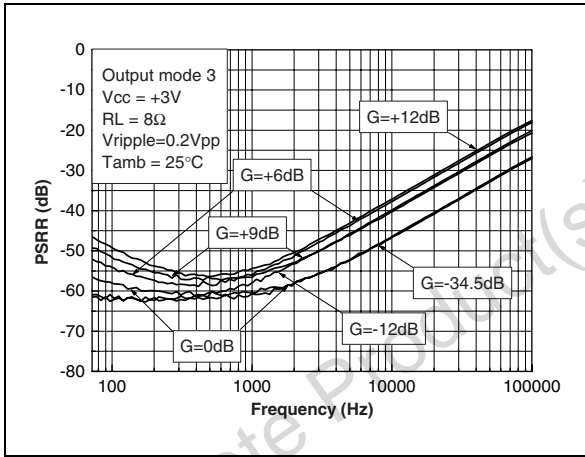

Figure 35: HDout PSRR vs. frequency
(output mode 4, inputs grounded)

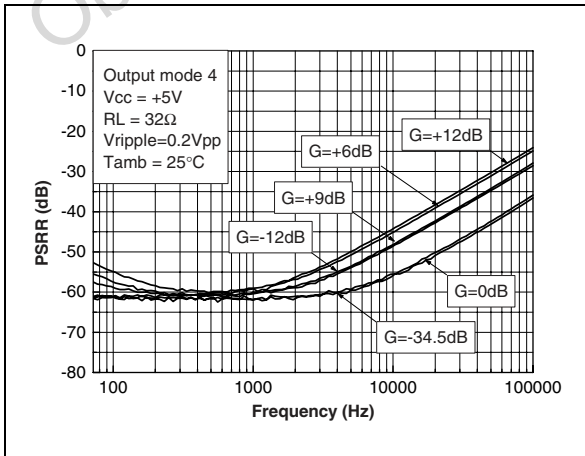

Figure 36: HDout PSRR vs. frequency
(output mode 4, inputs grounded)

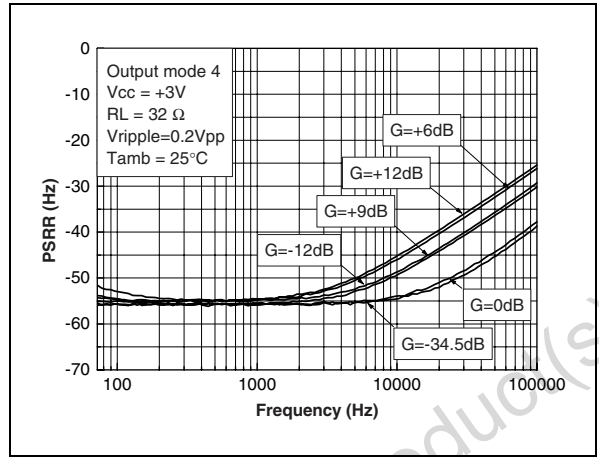

Figure 37: Spkout PSRR vs. frequency
(output mode 5, inputs grounded)

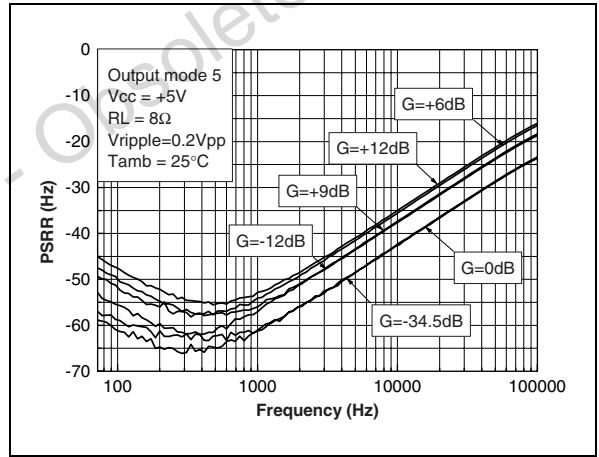

Figure 38: Spkout PSRR vs. frequency
(output mode 5, inputs grounded)

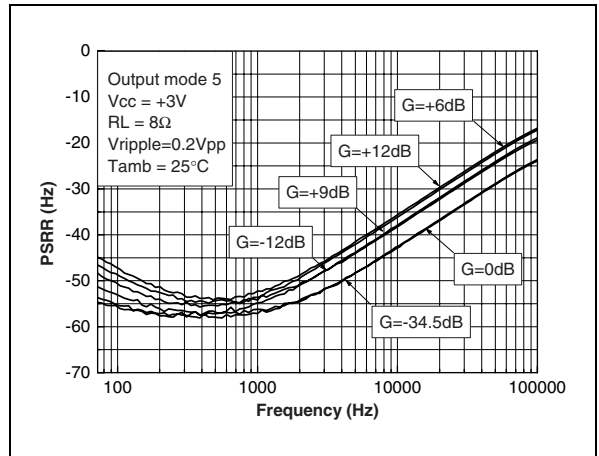

Figure 39: HDout PSRR vs. frequency (output modes 6, 7, inputs grounded)

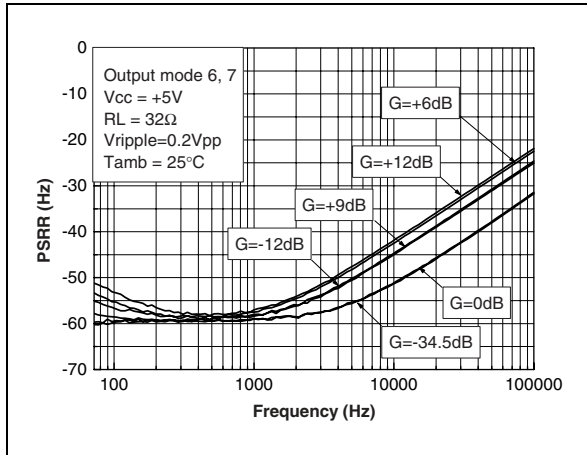

Figure 40: HDout PSRR vs. freq., (output modes 6, 7, inputs grounded)

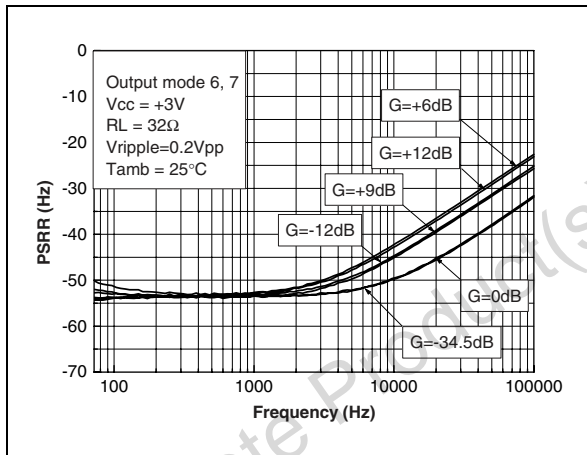

Figure 41: Spkout frequency response (output mode 1, 7)

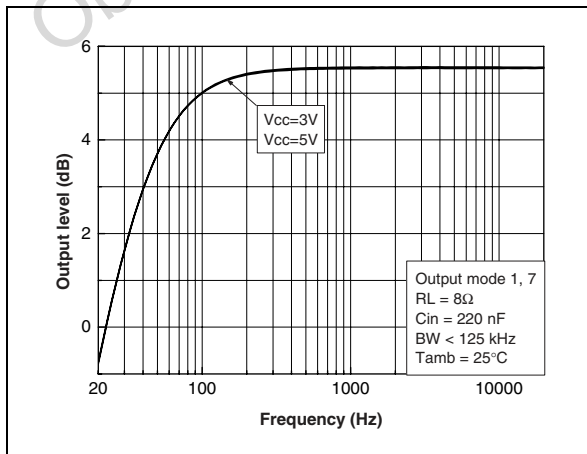

Figure 42: HDout frequency response (output mode 2)

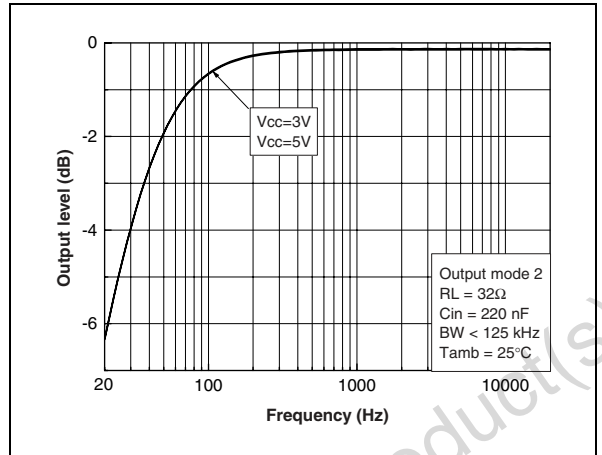

Figure 43: Spkout frequency response (output mode 3)

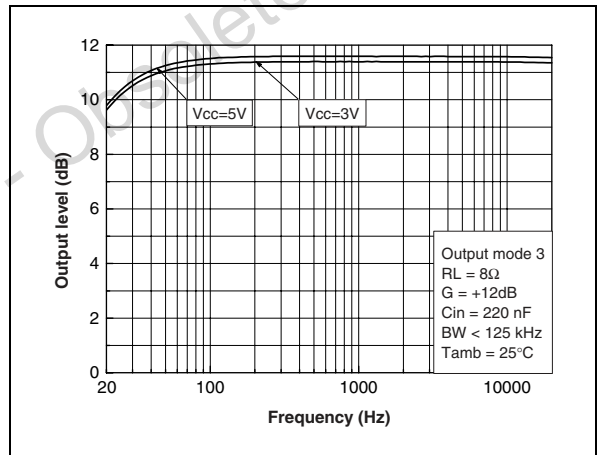

Figure 44: HDout frequency response (output mode 4)

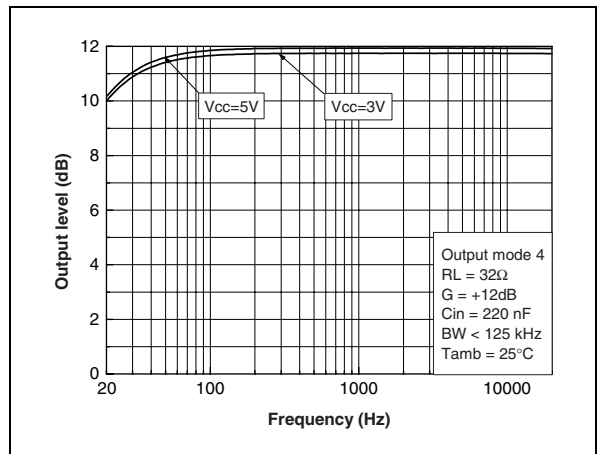

Figure 45: Spkout SNR vs. power supply voltage, unweighted filter, BW = 20 Hz to 20 kHz

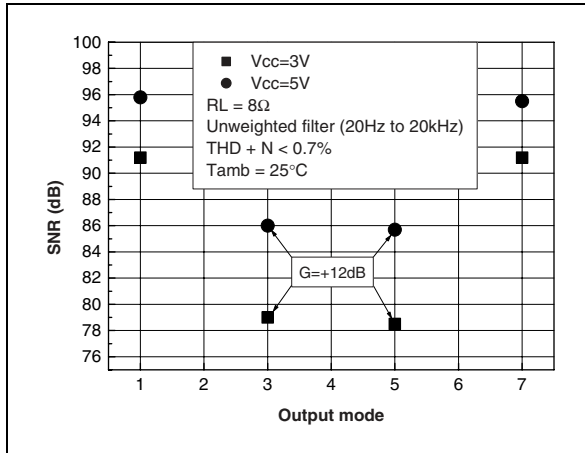

Figure 47: Hdout SNR vs. power supply voltage, unweighted filter, BW = 20 Hz to 20 kHz

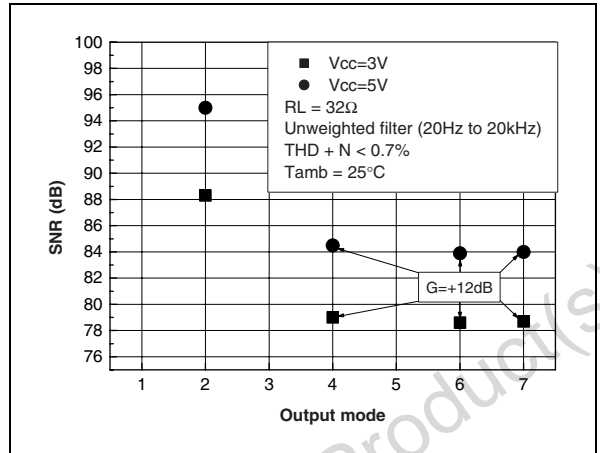

Figure 46: Spkout SNR vs. power supply voltage, weighted filter A, BW = 20 Hz to 20 kHz

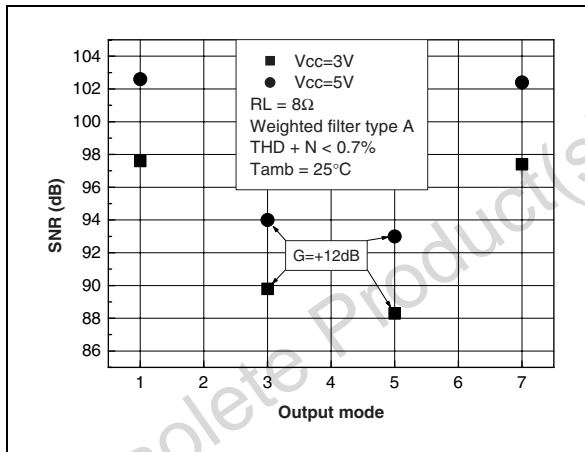

Figure 48: Hdout SNR vs. power supply voltage, weighted filter A, BW = 20 Hz to 20 kHz

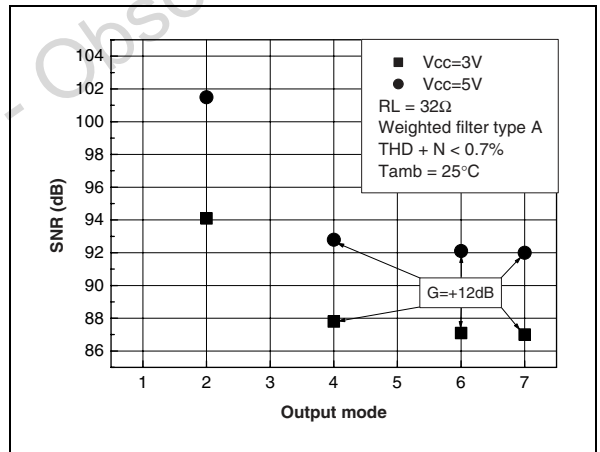

Figure 49: Crosstalk vs. frequency (output mode 4)

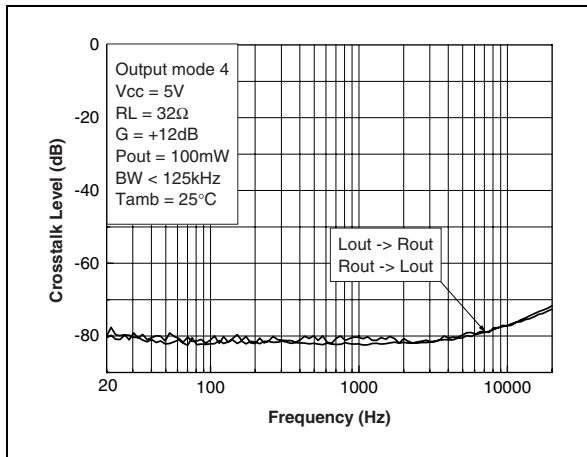

Figure 52: -3 dB lower cut off frequency vs. input capacitance

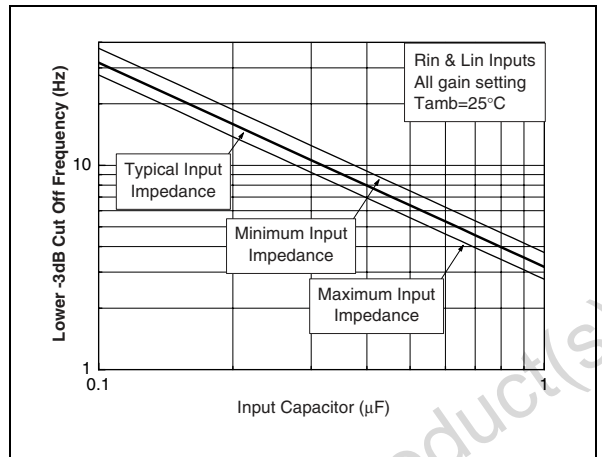

Figure 50: Crosstalk vs. frequency (output mode 4)

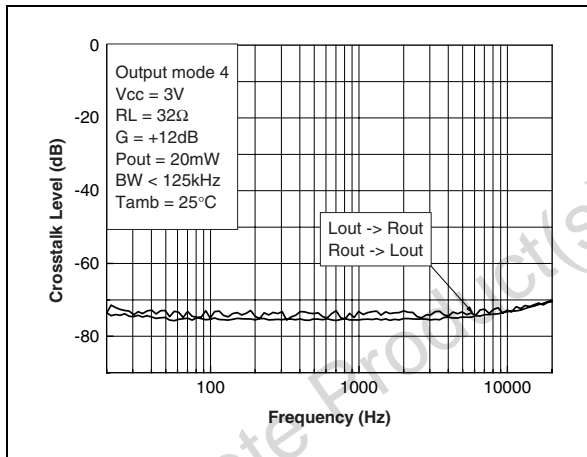

Figure 53: Current consumption vs. power supply voltage

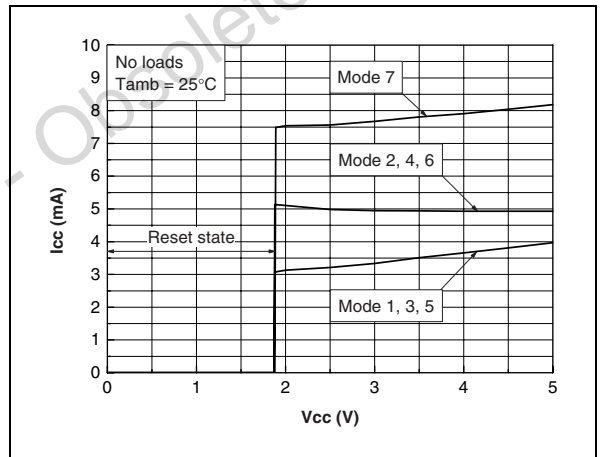

Figure 51: -3 dB lower cut off frequency vs. input capacitor

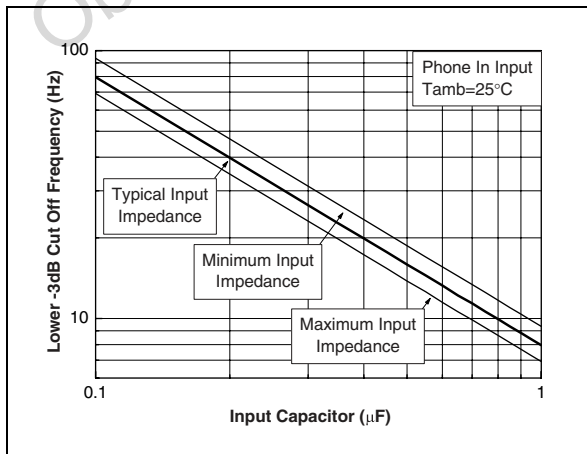

Figure 54: Power dissipation vs. output power (speaker output)

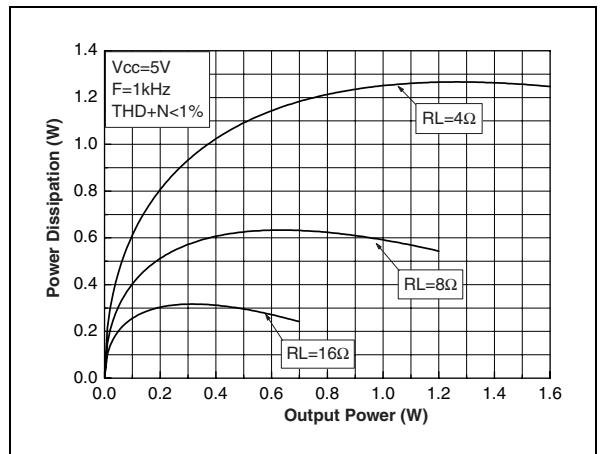

Figure 55: Power dissipation vs. output power (speaker output)

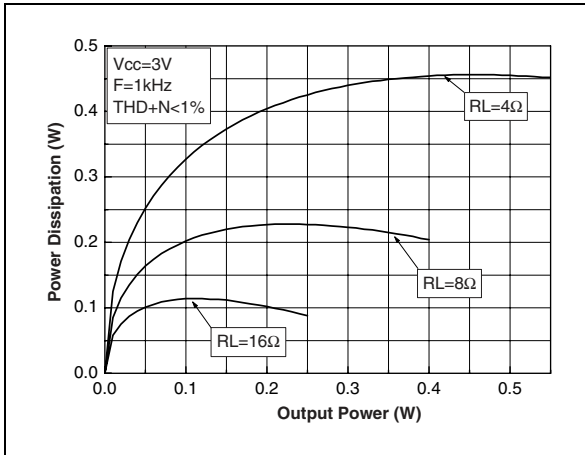

Figure 56: Power dissipation vs. output power (headphone output, one channel)

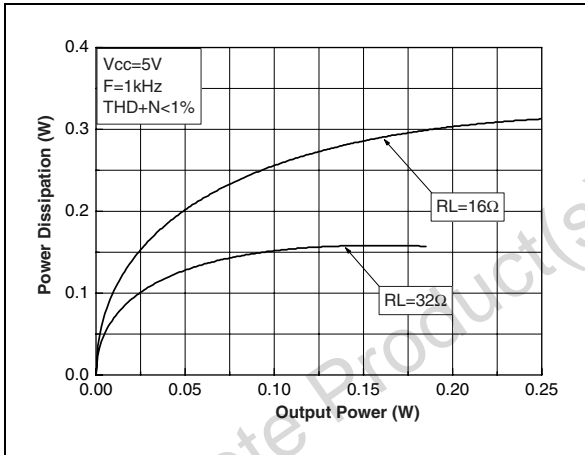

Figure 57: Power dissipation vs. output power (headphone output one channel)

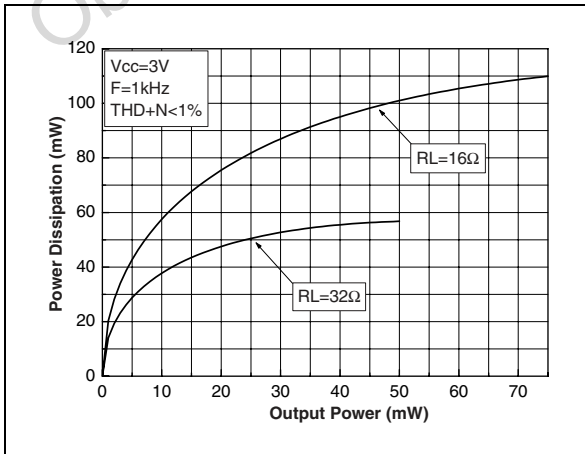

Figure 58: Power derating curves

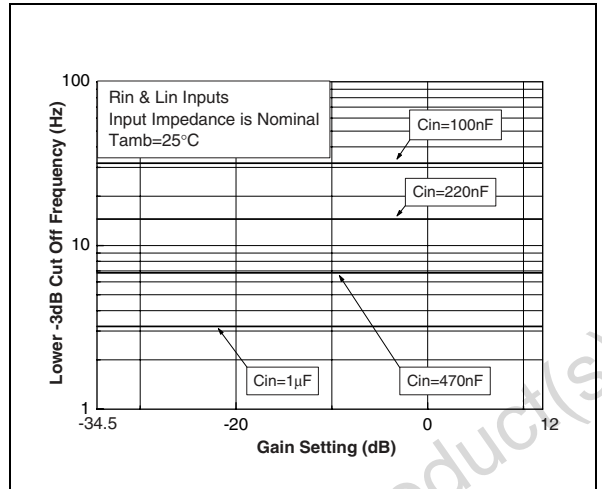

Figure 59: -3 dB lower cut off frequency vs. gain setting (output modes 3, 4, 5, 6, 7)

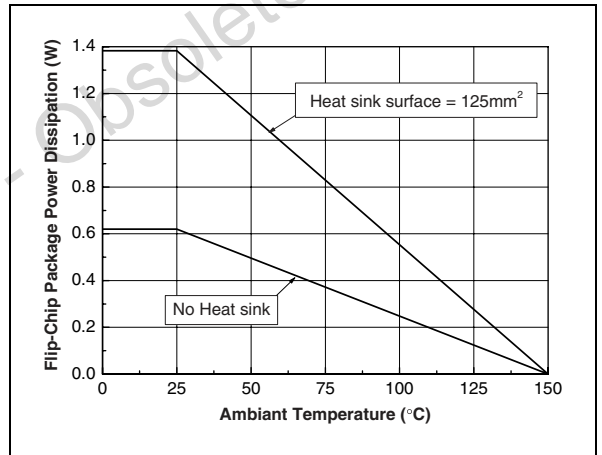

Table 11. Output noise (all inputs grounded)

Output Mode	Unweighted Filter from 3V to 5V	Weighted Filter (A) from 3V to 5V
1	23μVrms	20μVrms
2	20μVrms	17μVrms
3	70μVrms	60μVrms
4	53μVrms	45μVrms
5	79μVrms	67μVrms
6	60μVrms	51μVrms

5 Application Information

5.1 BTL configuration principles

The TS4851 integrates 3 monolithic power amplifier having BTL output. BTL (Bridge Tied Load) means that each end of the load is connected to two single-ended output amplifiers. Thus, we have:

$$\text{Single ended output 1} = V_{\text{out1}} = V_{\text{out}} \text{ (V)}$$

$$\text{Single ended output 2} = V_{\text{out2}} = -V_{\text{out}} \text{ (V)}$$

and

$$V_{\text{out1}} - V_{\text{out2}} = 2V_{\text{out}} \text{ (V)}$$

The output power is:

$$P_{\text{out}} = \frac{(2 V_{\text{out RMS}})^2}{R_L} \text{ (W)}$$

For the same power supply voltage, the output power in BTL configuration is four times higher than the output power in single ended configuration.

5.2 Power dissipation and efficiency

Hypotheses:

- Voltage and current in the load are sinusoidal (V_{out} and I_{out}).
- Supply voltage is a pure DC source (V_{CC}).

Regarding the load we have:

$$V_{\text{OUT}} = V_{\text{PEAK}} \sin \omega t \text{ (V)}$$

and

$$I_{\text{OUT}} = \frac{V_{\text{OUT}}}{R_L} \text{ (A)}$$

and

$$P_{\text{OUT}} = \frac{V_{\text{PEAK}}^2}{2R_L} \text{ (W)}$$

Then, the average current delivered by the supply voltage is:

$$I_{\text{CC AVG}} = 2 \frac{V_{\text{PEAK}}}{\pi R_L} \text{ (A)}$$

The power delivered by the supply voltage is:

$$P_{\text{supply}} = V_{\text{CC}} I_{\text{CC AVG}} \text{ (W)}$$

Then, the **power dissipated by each amplifier** is

$$P_{\text{diss}} = P_{\text{supply}} - P_{\text{out}} \text{ (W)}$$

$$P_{\text{diss}} = \frac{2\sqrt{2} V_{\text{CC}}}{\pi\sqrt{R_L}} \sqrt{P_{\text{OUT}}} - P_{\text{OUT}} \text{ (W)}$$

and the maximum value is obtained when:

$$\frac{\partial P_{diss}}{\partial P_{OUT}} = 0$$

and its value is:

$$P_{dissmax} = \frac{2V_{CC}^2}{\pi^2 R_L} \text{ (W)}$$

Note: This maximum value is depends only on power supply voltage and load values.

The **efficiency** is the ratio between the output power and the power supply:

$$\eta = \frac{P_{OUT}}{P_{supply}} = \frac{\pi V_{PEAK}}{4V_{CC}}$$

The maximum theoretical value is reached when $V_{peak} = V_{CC}$, so:

$$\frac{\pi}{4} = 78.5\%$$

The TS4851 has three independent power amplifiers. Each amplifier produces heat due to its power dissipation. Therefore, the maximum die temperature is the sum of each amplifier's maximum power dissipation. It is calculated as follows:

- $P_{diss\ speaker}$ = Power dissipation due to the speaker power amplifier.
- $P_{diss\ head}$ = Power dissipation due to the Headphone power amplifier
- Total $P_{diss} = P_{diss\ speaker} + P_{diss\ head1} + P_{diss\ head2}$ (W)

In most cases, $P_{diss\ head1} = P_{diss\ head2}$, giving:

$$Total\ P_{diss} = P_{diss\ speaker} + 2P_{diss\ head} \text{ (W)}$$

$$TotalP_{diss} = \frac{2\sqrt{2}V_{CC}}{\pi} \left[\sqrt{\frac{P_{OUT\ SPEAKER}}{R_{LSPEAKER}}} + 2\sqrt{\frac{P_{OUT\ HEAD}}{R_{LHEAD}}} \right] - [P_{OUT\ SPEAKER} + 2P_{OUT\ HEAD}] \text{ (W)}$$

The following graph (Figure 60) shows an example of the previous formula, with V_{CC} set to +5V, $R_{load\ speaker}$ set to 8Ω and $R_{load\ headphone}$ set to 16Ω .

Figure 60: Example of total power dissipation vs. speaker and headphone output power

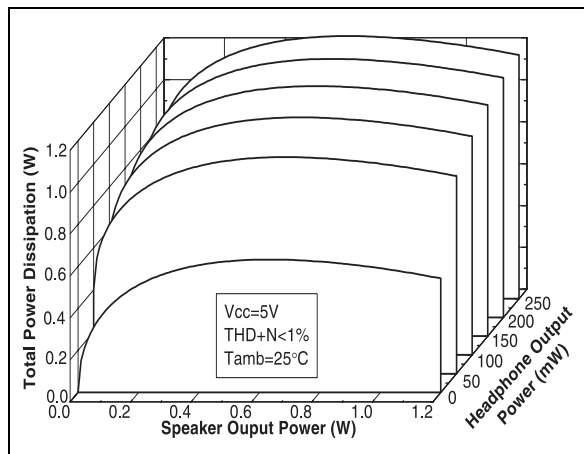

5.3 Low frequency response

In low frequency region, the effect of C_{in} starts. C_{in} with Z_{in} forms a high pass filter with a -3dB cut off frequency.

$$F_{CL} = \frac{1}{2 \pi Z_{in} C_{in}} \text{ (Hz)}$$

Z_{in} is the input impedance of the corresponding input:

- 20k Ω for Phone In IHF input
- 50k Ω for the 3 other inputs

Note: For all inputs, the impedance value remains constant for all gain settings. This means that the lower cut-off frequency doesn't change with gain setting. Note also that 20k Ω and 50k Ω are typical values and there are tolerances around these values (see [Electrical Characteristics](#) on page 7).

In [Figures 39](#) to [41](#), you could easily establish the C_{in} value for a -3dB cut-off frequency required.

5.4 Decoupling of the circuit

Two capacitors are needed to bypass properly the TS4851, a power supply bypass capacitor C_s and a bias voltage bypass capacitor C_b .

C_s has especially an influence on the THD+N in high frequency (above 7kHz) and indirectly on the power supply disturbances.

With 1 μ F, you could expect similar THD+N performances like shown in the datasheet.

If C_s is lower than 1 μ F, THD+N increases in high frequency and disturbances on the power supply rail are less filtered.

To the contrary, if C_s is higher than 1 μ F, those disturbances on the power supply rail are more filtered.

C_b has an influence on THD+N in lower frequency, but its value is critical on the final result of PSRR with input grounded in lower frequency:

- If C_b is lower than 1 μ F, THD+N increases at lower frequencies and the PSRR worsens upwards.
- If C_b is higher than 1 μ F, the benefit on THD+N and PSRR in the lower frequency range is small.

5.5 Startup time

When the TS4851 is controlled to switch from the full standby mode (output mode 0) to another output mode, a delay is necessary to stabilize the DC bias. This delay depends on the C_b value and can be calculated by the following formulas.

Typical startup time = 0.0175 x C_b (s)

Max. startup time = 0.025 x C_b (s)

(C_b is in μ F in these formulas)

These formulas assume that the C_b voltage is equal to 0V. If the C_b voltage is not equal to 0V, the startup time will be always lower.

The startup time is the delay between the negative edge of Enable input (see [Description of SPI operation](#) on page 3) and the power ON of the output amplifiers.

Note: When the TS4851 is set in full standby mode, C_b is discharged through an internal switch.. The time to reach 0V of C_b voltage is about ms.

5.6 Pop and Click performance

The TS4851 has internal Pop and Click reduction circuitry. The performance of this circuitry is closely linked with the value of the input capacitor C_{in} and the bias voltage bypass capacitor C_b .

The value of C_{in} is due to the lower cut-off frequency value requested. The value of C_b is due to THD+N and PSRR requested always in lower frequency.

The TS4851 is optimized to have a low pop and click in the typical schematic configuration (see [page 2](#)).

Note: The value of C_s is not an important consideration as regards pop and click.

5.7 Notes on PSRR measurement

What is the PSRR?

The PSRR is the Power Supply Rejection Ratio. The PSRR of a device, is the ratio between a power supply disturbance and the result on the output. We can say that the PSRR is the ability of a device to minimize the impact of power supply disturbances to the output.

How we measure the PSRR?

The PSRR was measured according to the schematic shown in [Figure 61](#).

Figure 61: PSRR measurement schematic

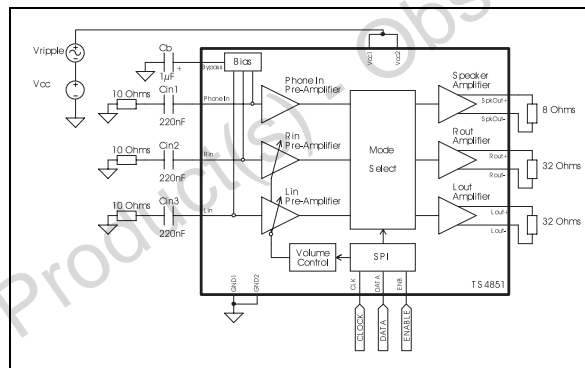

Principles of operation

- The DC voltage supply (V_{cc}) is fixed.
- The AC sinusoidal ripple voltage (V_{ripple}) is fixed.
- No bypass capacitor C_s is used.

The PSRR value for each frequency is:

$$PSRR = 20 \times \text{Log} \left[\frac{RMS_{(Output)}}{RMS_{(Vripple)}} \right] \quad (\text{dB})$$

RMS is a rms selective measurement.

5.8 Power-On Reset

When Power is applied to V_{dd} , an internal Power On Reset holds the TS4851 in a reset state until the Supply Voltage reached its nominal value.

The Power On reset has a typical threshold at 1.8V.

6 Package Information

Flip-chip - 18 bumps: TS4851JT

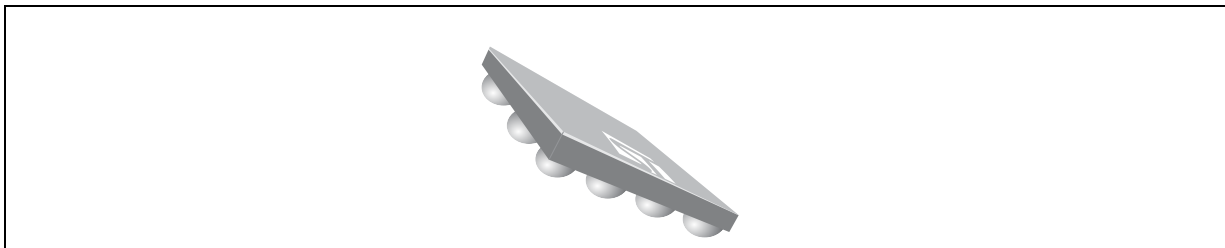

Pin out (top view)

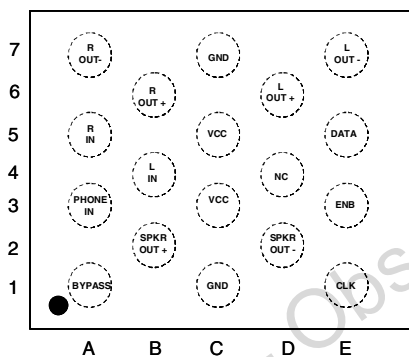

Note: The solder bumps are on the underside.

Marking (top view):

The following markings are present on the topside of the flip-chip:

- The ST logo.
- The part number: A51.
- A 3-digit date code: YWW.
- A dot marking the location of Pin1A.

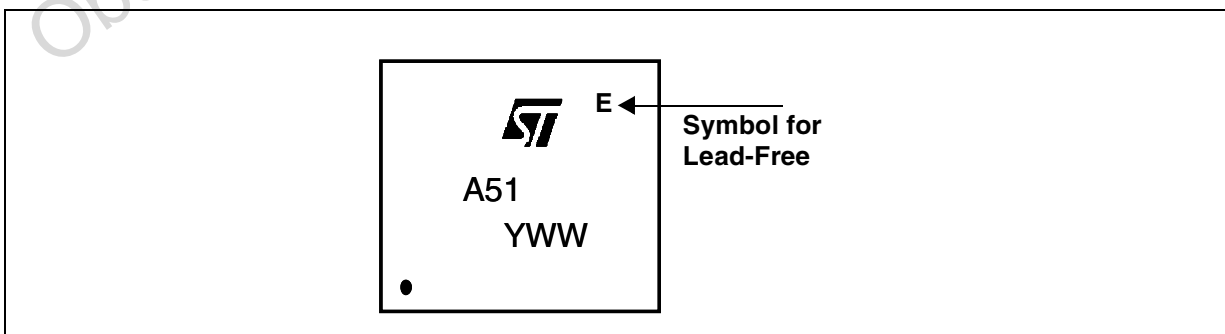

TS4851 Footprint recommendation

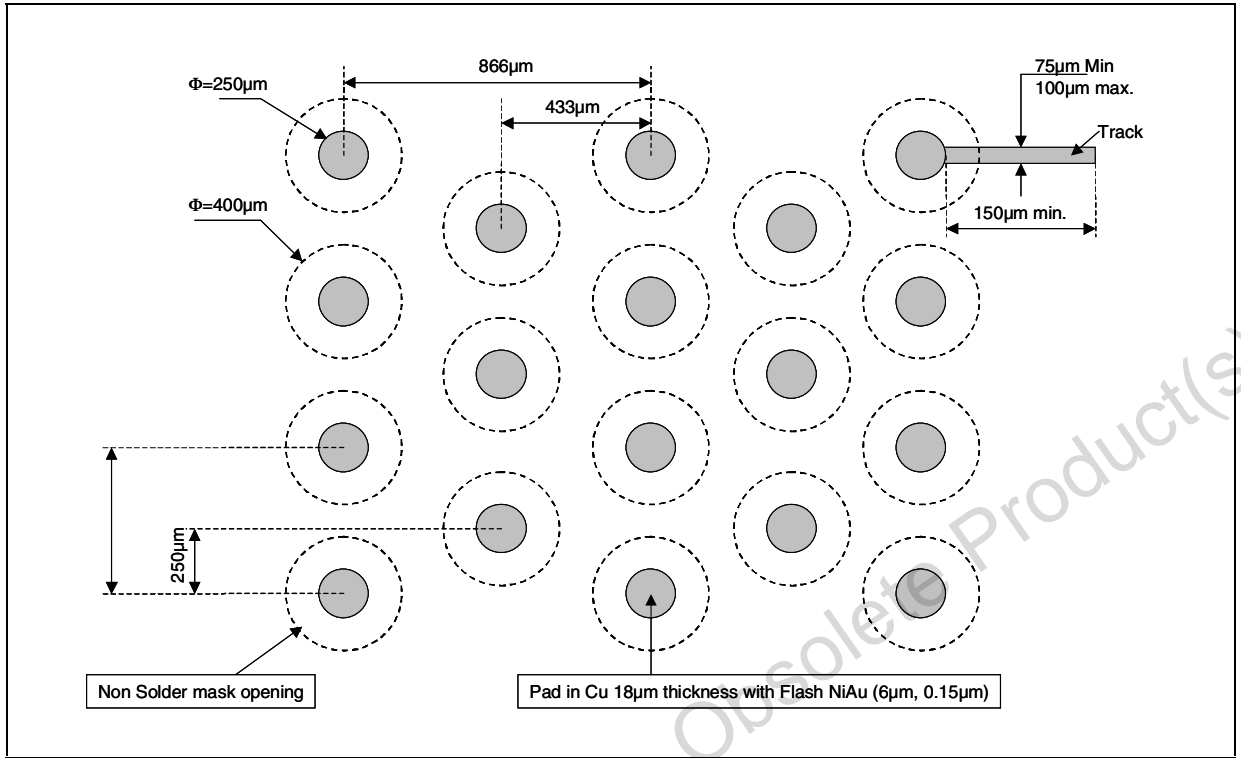

Package mechanical data

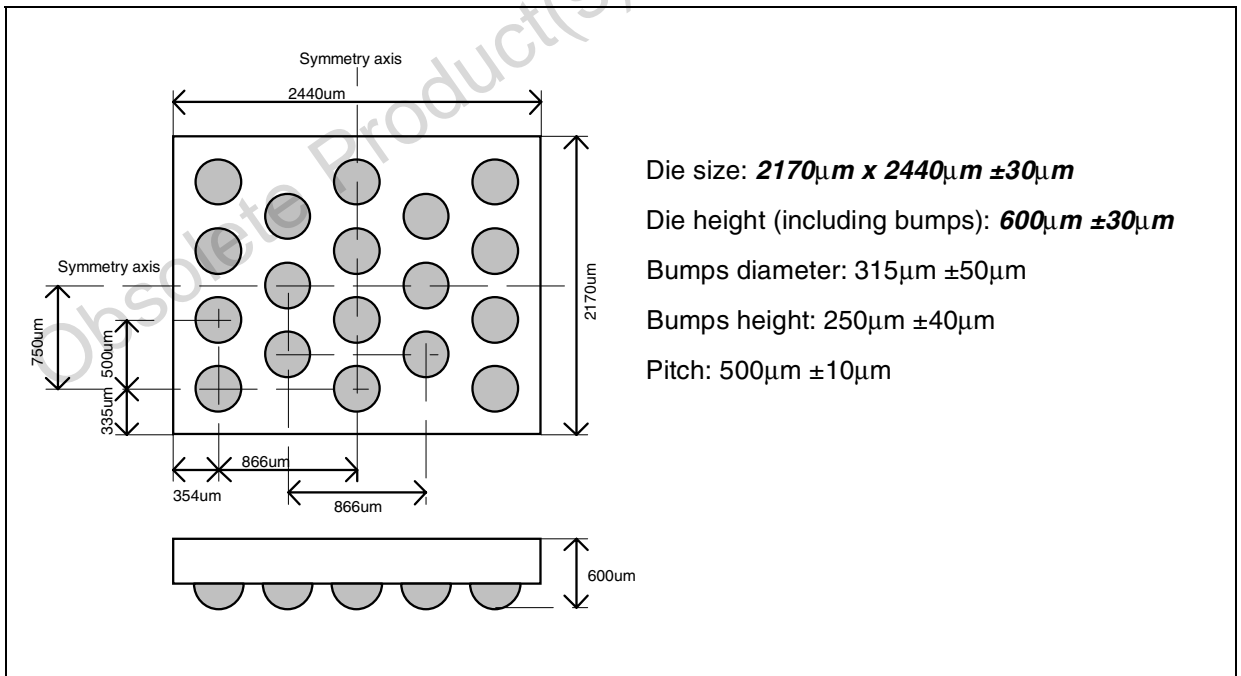

7 Daisy Chain Samples

A daisy chain sample is a “dummy” silicon chip that can be used to test your flip-chip soldering process and connection continuity. The daisy chain sample features paired connections between bumps, as shown in the schematic below. On your PCB layout, you should design the bump connections such that they are complementary to the above schema (meaning that different pairs of bumps are connected on the PCB side). In this way, by simply connecting an ohmmeter between pin 1A and pin 5A, you can test the continuity of your soldering process.

The order code for daisy chain samples is given below.

Figure 62: Daisy chain sample mechanical data

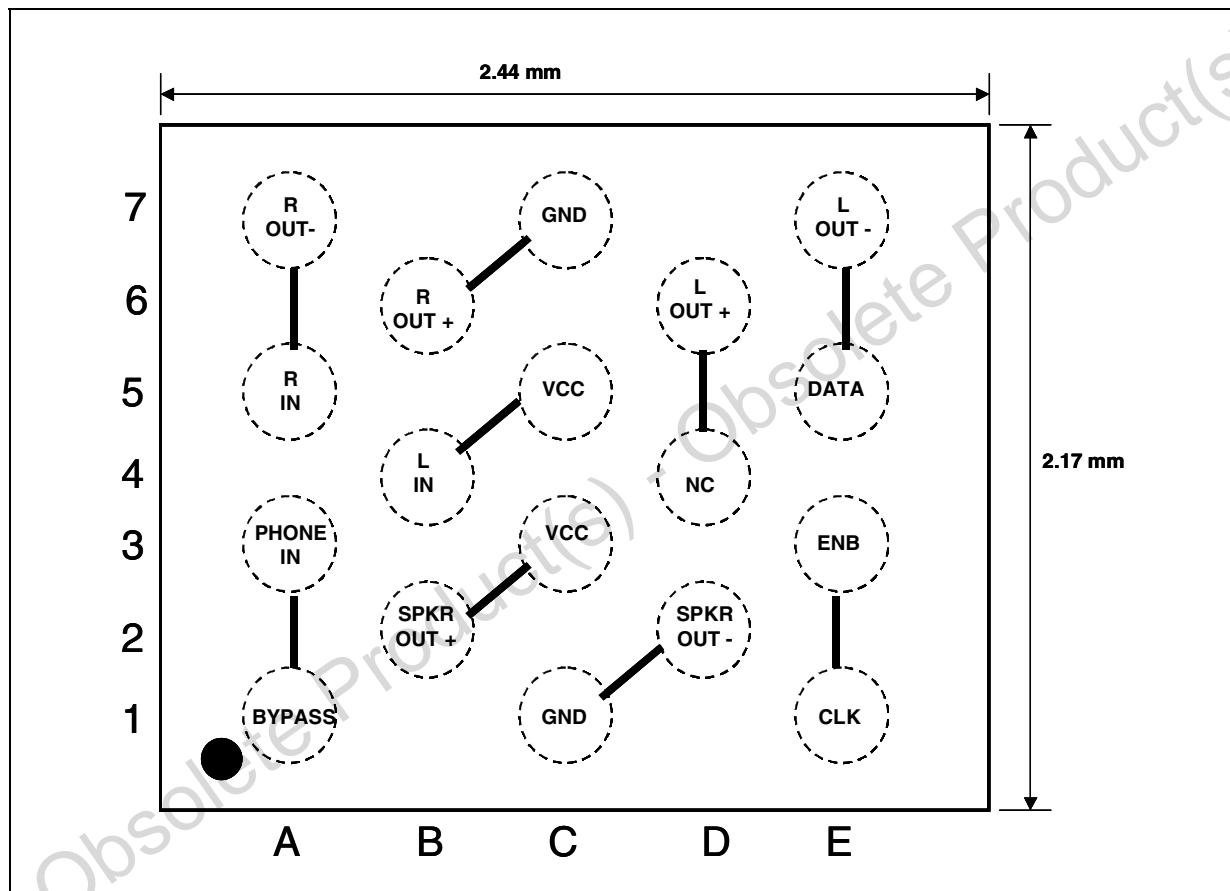

Order code for daisy chain samples

Part Number	Temperature Range	Package	Marking
		J	
TSDC02IJT	-40, +85°C	•	DC2

8 Tape & Reel Specification

Figure 63: Top view of tape and reel

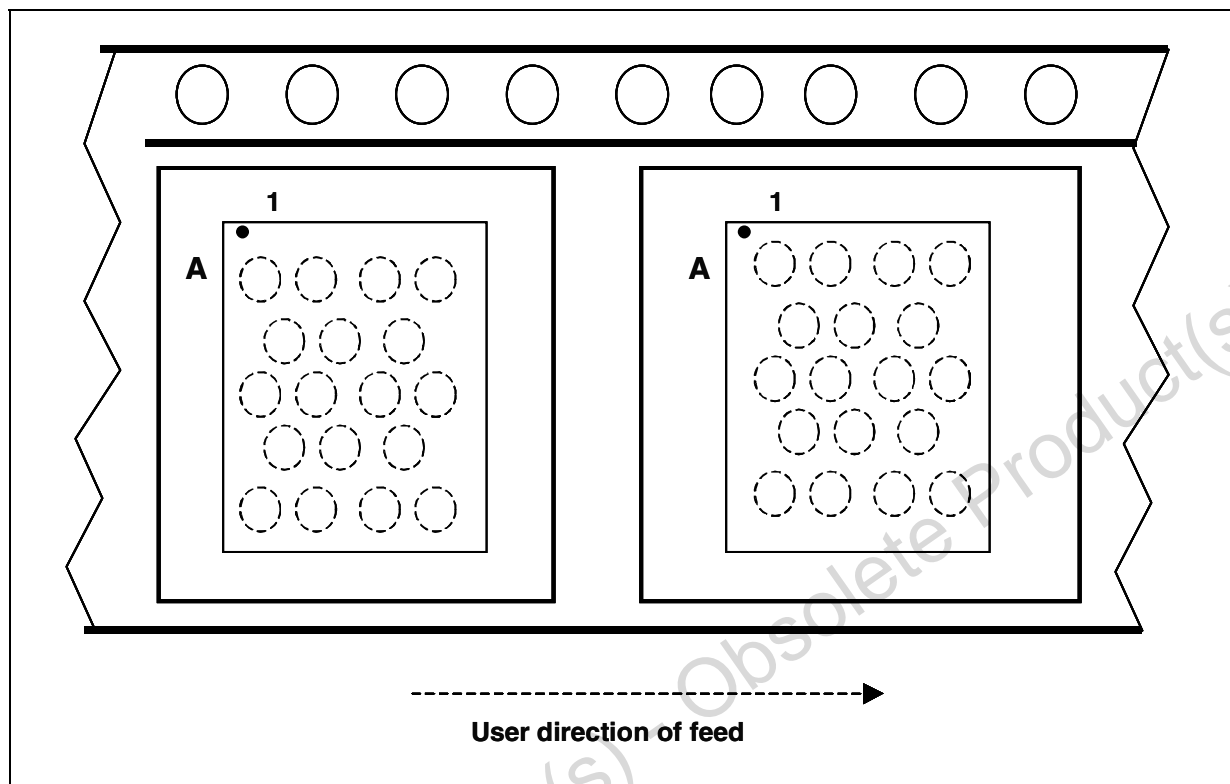

Device orientation

The devices are oriented in the carrier pocket with pin number 1A adjacent to the sprocket holes.

9 Revision History

Date	Revision	Description of Changes
01 July 2002	1	First Release
01 April 2003	2	Curves inserted in the document
01 April 2004	3	Curves updated in the document
01 Jan. 2005	4	Leadfree codification added in the document
01 March 2005	5	Realignment of curve data in the document

Information furnished is believed to be accurate and reliable. However, STMicroelectronics assumes no responsibility for the consequences of use of such information or for any infringement of patents or other rights of third parties which may result from its use. No license is granted by implication or otherwise under any patent or patent rights of STMicroelectronics. Specifications mentioned in this publication are subject to change without notice. This publication supersedes and replaces all information previously supplied. STMicroelectronics products are not authorized for use as critical components in life support devices or systems without express written approval of STMicroelectronics.

The ST logo is a registered trademark of STMicroelectronics
All other names are the property of their respective owners

© 2005 STMicroelectronics - All rights reserved

STMicroelectronics group of companies

Australia - Belgium - Brazil - Canada - China - Czech Republic - Finland - France - Germany - Hong Kong - India - Israel - Italy - Japan - Malaysia - Malta - Morocco - Singapore - Spain - Sweden - Switzerland - United Kingdom - United States of America

www.st.com