

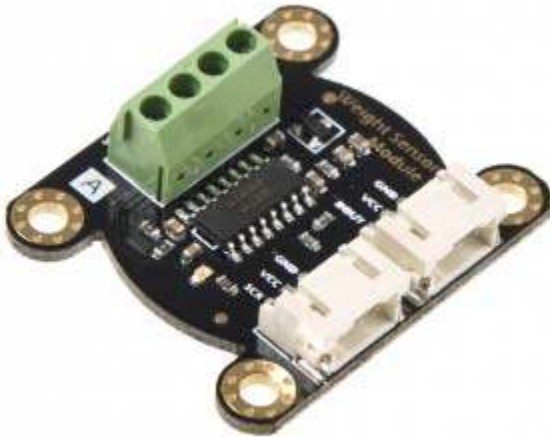

Weight Sensor Module SKU:SEN0160



Contents

- 1 Introduction
- 2 Specification
 - 2.1 24-Bit Analog-to-Digital Converter for Weight Scales (HX711)
 - 2.2 Weight Sensor Module
- 3 Tutorial
 - 3.1 Hardware Requirement
 - 3.1.1 Connection Diagram
 - 3.2 Software Requirement
 - 3.3 Detail Steps
- 4 The structure of the weight sensor

Introduction

Weight Sensor Module is based on HX711, which is a precision 24-bit analog-to-digital converter designed for weigh scale and industrial control applications to interface directly with a bridge sensor. Compared with other chips, HX711 not only has a few basic functions, also contains high integration, fast response, immunity, and other features. The chip lowers the cost of the electronic scale, at the same time, improving the performance and reliability.

The input interface of this weight sensor module is used sensor interface, which is compatible with Arduino I/O port. The output adopts compact terminal that makes weight sensor module easier to connect the weight sensor. It's the best choice for electronic enthusiasts to do some tiny home scale.

The weight sensor module can be combined with weight sensor on the market. We also help you to pick a small range of weight sensor.

Specification

24-Bit Analog-to-Digital Converter for Weight Scales (HX711)

- Two selectable differential input channels
- On-chip active low noise PGA with selectable gain of 32,64 and 128
- On-chip power supply regulator for load-cell and ADC analog power supply
- On-chip oscillator requiring no external component with optional external crystal
- On-chip power-on-rest
- Simple digital control and serial interface: pin-driven controls, no programming needed
- Selectable 10SPS or 80SPS output data rate
- Simultaneous 50 and 60Hz supply rejection
- Supply Voltage: 2.6V~5.5V
- Current: <1.6mA
- Working temperature: -40~85°C
- 16 pin SOP-16 package

Weight Sensor Module

- Range:1kg
- Excitation voltage: 5-15 V
- Output sensitivity: 1.0±0.15mV/V
- Synthetical error: 1 per thousand cent of full scale
- Zero shift: 0.05/0.03 (30min) %F.S
- Zero temperature shift: 0.05/0.03 %F.S/10°C
- Zero output: ±0.1mV/V
- Input impedance: 1055±15 Ω
- Output impedance: 1000±5 Ω
- Overload capability: 200 %F.S
- Output: Analog output
- Size: 33mm*38mm

Tutorial

The range of the weight scale is only 1kg. So, it's very appropriate for you to make a kitchen scale.we will bring you a step by step tutorial to make one and print the data by Arduino Serial Monitor.

Hardware Requirement

1. 1x DFRduino UNO R3
2. 1x Weight Sensor Module
3. 1x IO Expansion Shield for Arduino V7.1

4. 1x Weighing platform Reference 3D model

Note: The weighing platform will be made by yourself according to the weight sensor machine drawing. The following figure shows the weight sensor machine drawing.

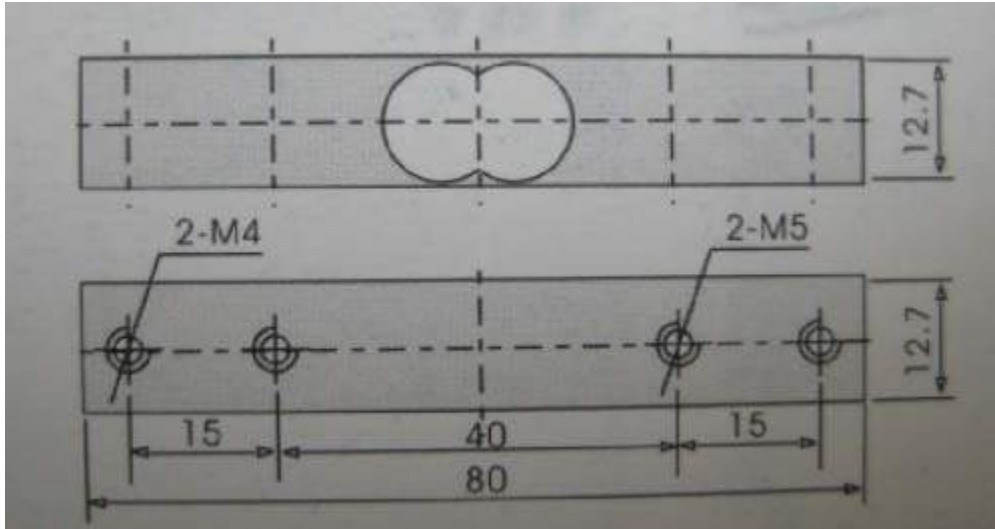

Machine Drawing

Connection Diagram

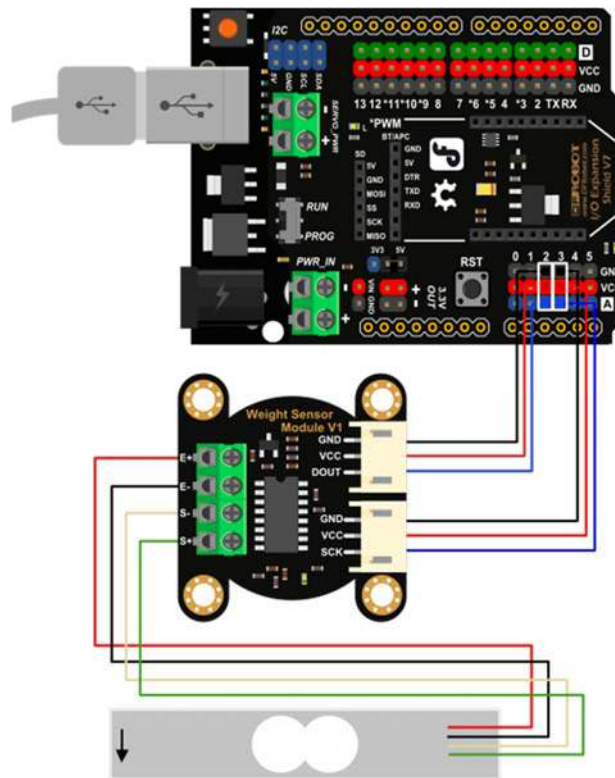

Connection Diagram

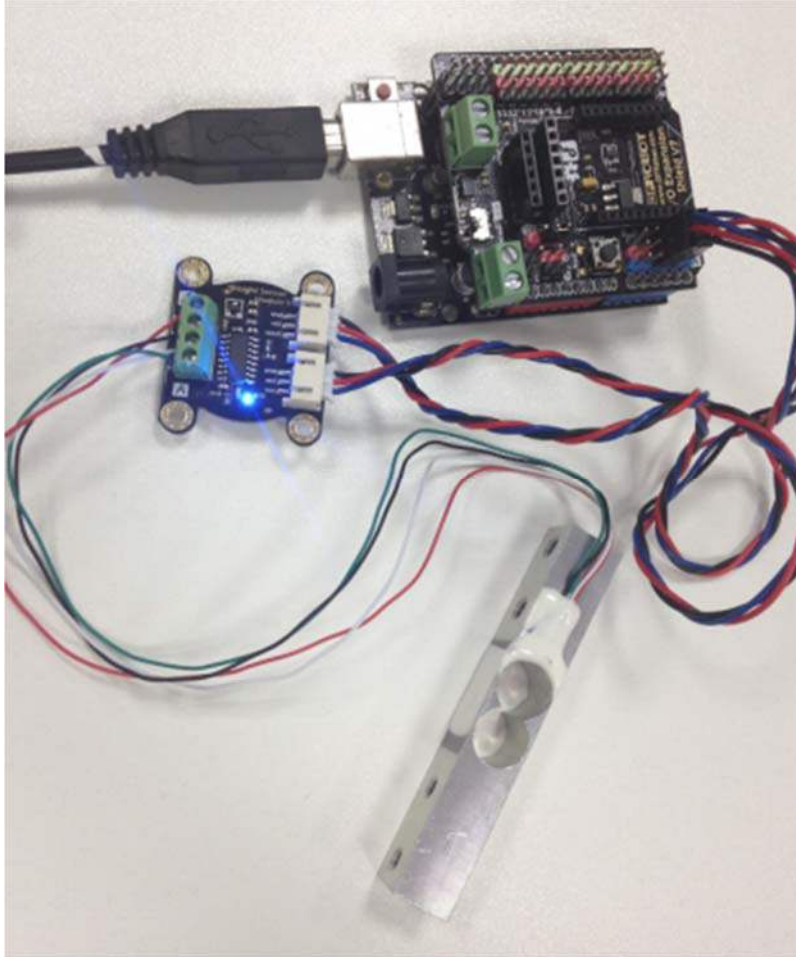

Physical wiring diagram

Software Requirement

- Arduino IDE
- Hx711 library

Detail Steps

1. Install the Arduino library to your Arduino IDE. Open the sample code ,which is named SerialScale.ino.

```
SerialScale | Arduino 1.0.5-r2
File Edit Sketch Tools Help
SerialScale
* library design: Weihong Guan (@nguegu)
* library host on
https://github.com/azuezy/ardulibs/tree/3c4b78f972740882c7f422156904fc1e4ed
*/

// Hx711.DOUT - pin #A2
// Hx711.SCK - pin #A3

#include <Hx711.h>
Hx711 scale(A2, A3);

void setup() {
  Serial.begin(9600);
}

void loop() {
  Serial.print(scale.getGram(), 1);
  Serial.println(" g");
  delay(200);
}

11 Arduino Leonardo on COM22
```

sample code

2. Upload the sample code to UNO. When finished, you put the weight sensor horizontally, one end with four wires is fixed on the table, the other one suspended.

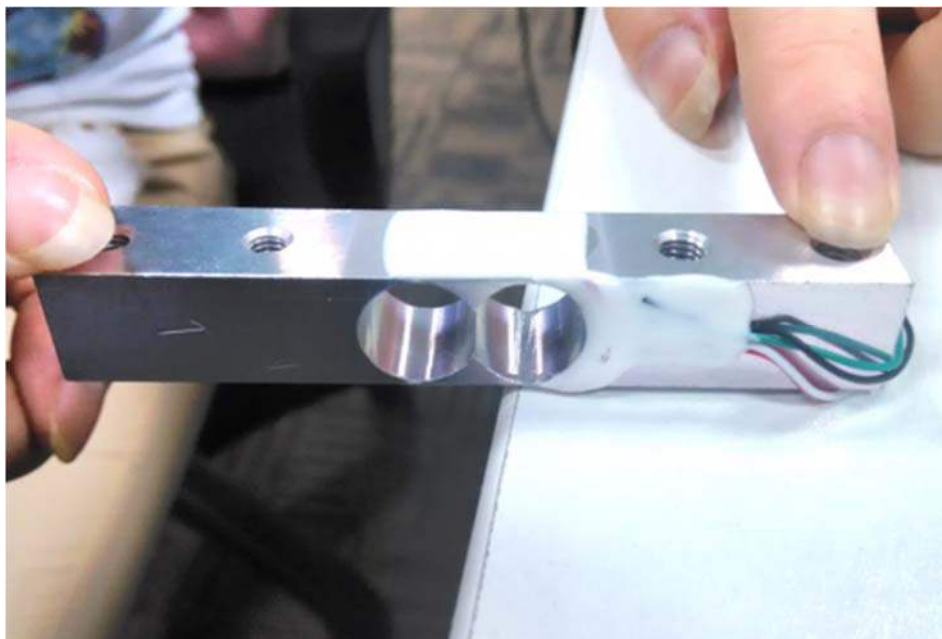

place the sensor

3. Open the Serial monitor, and press the sensor according to the label direction.



label direction

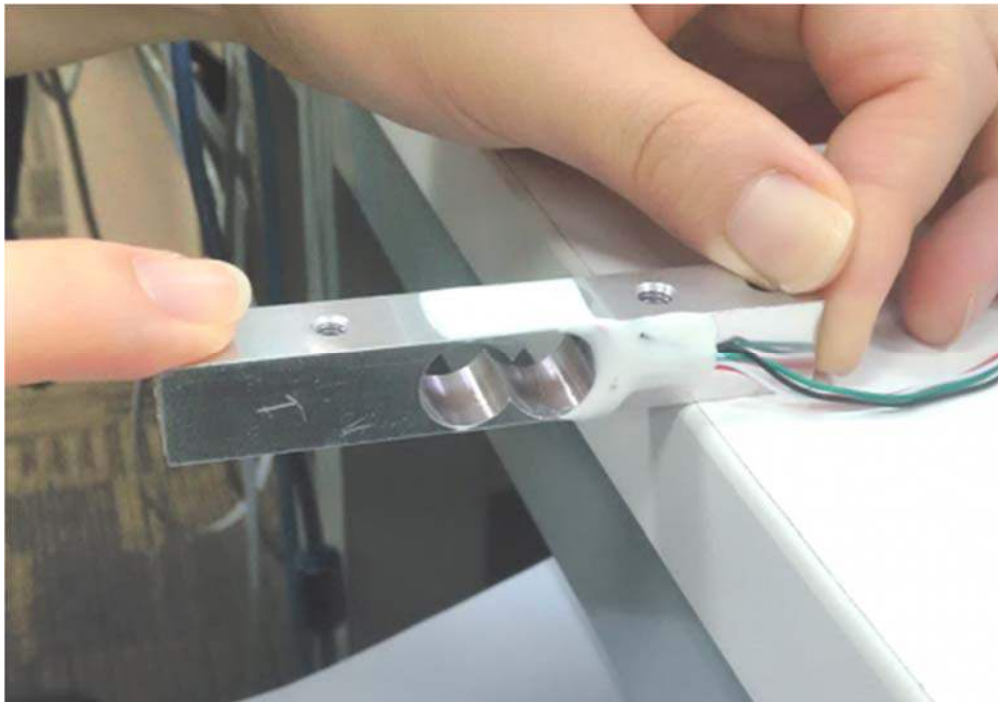

press the sensor

Check the Serial monitor, when you press the sensor

Left image: Normal data.The date will have a growth process with different intensity of hand.

Right image:Abnormal data.

Possible Reasons:

- a. Forced direction is wrong.
- b. Maybe the connection isn't firm.

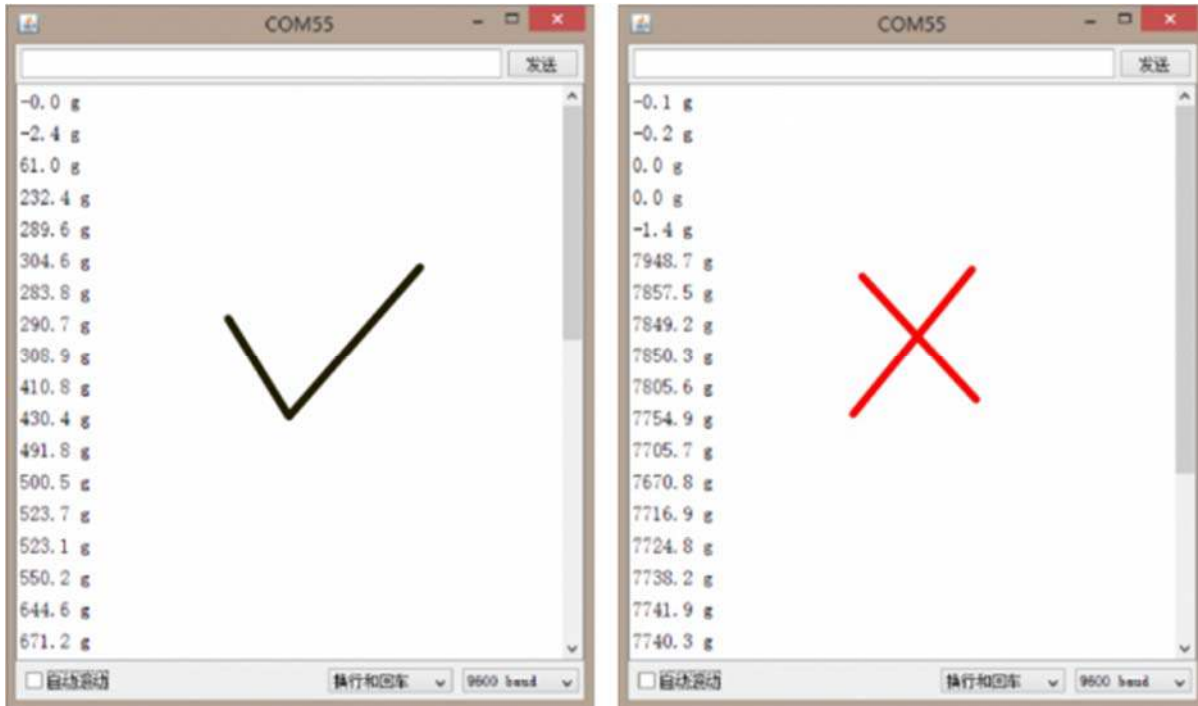

The date in the Serial Monitor

4. Install the weighing platform

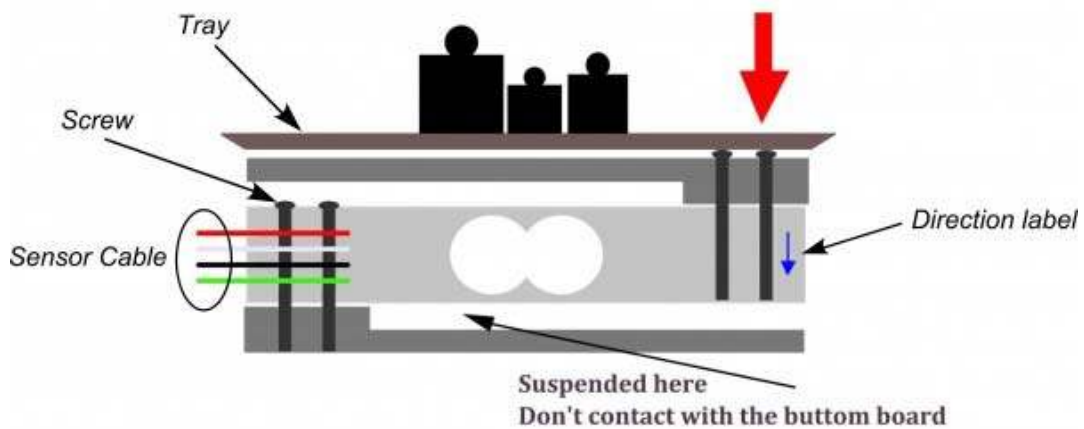

weight platform

5. Thus, far ,the weight scale will be finished within one more step-- zero adjustment.

Open the Hx711 library folder , and find the file Hx711.h, open it. Locate the statement

```
void setScale(float scale = 1992.f);
```

You only need to adjust the number 1992 to find the appropriate value for weight scale. Save the h file, and upload the above code again.

The structure of the weight sensor

