

## **TPS826xxEVM**

This user's guide describes the characteristics, operation, and use of the TPS826xxEVM-646 evaluation module (EVM). The TPS826xxEVM-646 is a fully assembled and tested platform for evaluating the performance of the [TPS82671](#), [TPS82672](#), [TPS82675](#), [TPS82690](#) and [TPS82695](#) high-frequency, synchronous, step-down dc-dc converters optimized for battery-powered portable applications. This document includes schematic diagrams, a printed circuit board (PCB) layout, bill of materials, and test data. Throughout this document, the abbreviations *EVM* and *TPS826xxEVM* and the term *evaluation module* are synonymous with the TPS826xxEVM-646 unless otherwise noted.

### **Contents**

1	Introduction .....	2
	1.1 Features .....	2
	1.2 Applications .....	2
	1.3 EVM Ordering Options .....	2
2	TPS826xxEVM Schematic .....	3
3	Connector and Test Point Descriptions .....	3
	3.1 Input / Output Connectors: TPS826xxEVM .....	3
	3.2 Jumpers and Switches .....	4
4	Test Configuration .....	5
	4.1 Hardware Setup .....	5
	4.2 Procedure .....	5
5	TPS826xxEVM Test Data .....	6
	5.1 Thermal Performance .....	6
6	TPS826xxEVM Assembly Drawings and Layout .....	8
7	Bill of Materials .....	11
8	Marking Information .....	11

### **List of Figures**

1	TPS826xxEVM Schematic.....	3
2	Hardware Board Connection .....	5
3	Top Side Thermal Measurement.....	6
4	Bottom Side Thermal Measurement.....	7
5	TPS826xxEVM Component Placement (Top View) .....	8
6	TPS826xxEVM Top-Side Copper (Top View) .....	9
7	TPS826xxEVM Bottom-Side Copper (Bottom View).....	10

## 1 Introduction

The TPS82671, TPS82672, TPS82675, TPS82690 and TPS82695 devices are series of high-frequency, synchronous, step-down dc-dc converters optimized for battery-powered portable applications. Intended for low-power applications, the TPS8267x support up to 600-mA load current and the TPS8269 support up to 500-mA and all allow the use of low-cost chip inductors and capacitors. With a wide input voltage range of 2.3 V to 4.8 V, the devices support applications powered by lithium-ion (Li-Ion) batteries with extended voltage ranges. Different fixed voltage output versions of the TPS826xx are available. These converters operate at a regulated 5.5-MHz (TPS8267x) and 4-MHz (TPS8269x) switching frequency and enter a power-save mode operation under light load currents in order to maintain high efficiency over the entire load current range. A PFM mode extends the battery life by reducing the quiescent current to 17  $\mu$ A (typ) during light load operation.

### 1.1 Features

- Input voltage range: 2.3 V up to 4.8 V
- Fixed output voltages
- Up to 600-mA output current (TPS8267x)
- Up to 500-mA output current (TPS8269x)
- 5.5-MHz regulated frequency operation (TPS8267x)
- 4-MHz regulated frequency operation (TPS8269x)
- Output capacitor discharge (optional)
- Total solution size: < 6.7 mm<sup>2</sup>

### 1.2 Applications

- Cell phones, smart phones
- WLAN, GPS, and Bluetooth® applications
- DTV tuners
- Point-of-Load (PoL) applications

### 1.3 EVM Ordering Options

Table 1 provides the ordering information for the various EVM options.

**Table 1. Ordering Information**

Orderable EVM Number	Device Part Number	Output Voltage	Maximum Output Current
<a href="#">TPS82671EVM-646</a>	<a href="#">TPS82671</a>	1.8 V	600 mA
<a href="#">TPS82672EVM-646</a>	<a href="#">TPS82672</a>	1.5 V	600 mA
<a href="#">TPS82675EVM-646</a>	<a href="#">TPS82675</a>	1.2 V	600 mA
<a href="#">TPS82690EVM-646</a>	<a href="#">TPS82690</a>	2.8 V	500 mA
<a href="#">TPS82695EVM-646</a>	<a href="#">TPS82695</a>	2.5 V	500 mA

## 2 TPS826xxEVM Schematic

Figure 1 illustrates the TPS826xxEVM-646 schematic.

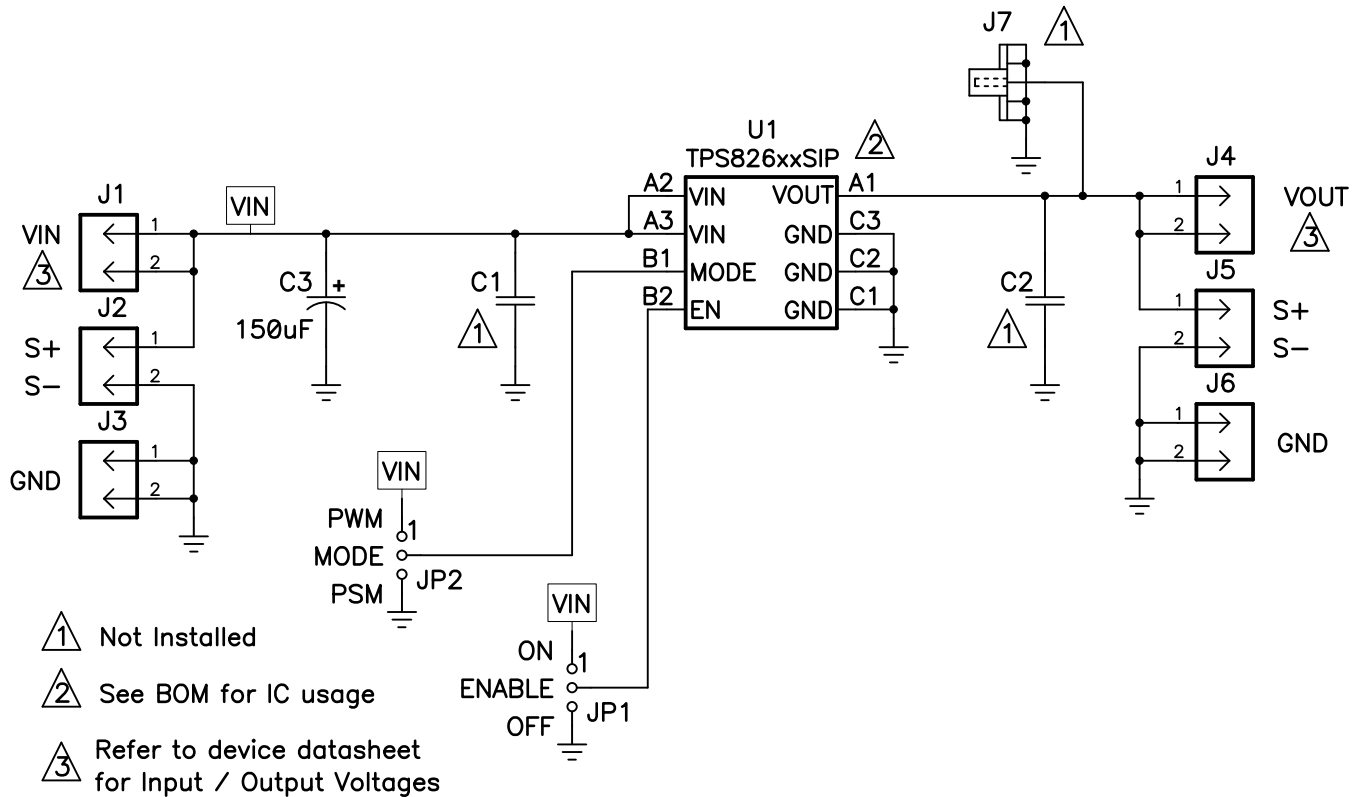

NOTE: For reference only; see Table 2 for specific values.

Figure 1. TPS826xxEVM Schematic

## 3 Connector and Test Point Descriptions

### 3.1 Input / Output Connectors: TPS826xxEVM

#### 3.1.1 J1 VIN

This header is the positive connection to the input power supply. The power supply must be connected between J1 and J3 (GND). The leads to the input supply should be twisted and kept as short as possible. The input voltage must be between 2.3 V and 4.8 V.

#### 3.1.2 J2 S+/S-

J2 S+/S- are the sense connection for the input of the converter. Connect a voltmeter, sense connection of a power supply, or oscilloscope to this header.

#### 3.1.3 J3 GND

This header is the return connection to the input power supply. Connect the power supply between J3 and J1 (VIN). The leads to the input supply should be twisted and kept as short as possible. The input voltage must be between 2.3 V and 4.8 V.

Capacitor C3 compensates for parasitic inductance as a result of the wires from the dc power supply to the EVM. It is not required in an actual application circuit.

### 3.1.4 J4 VOUT

This header is the positive output of the step-down converter. The output voltage of the devices in the TPS826xx families have fixed output voltages; refer to the specific device data sheet for detailed information on the device output voltage.

### 3.1.5 J5 S+/S-

J5 S+/S- are the sense connection for the output of the converter. Connect a voltmeter, sense connection of an electronic load, or oscilloscope to this header.

### 3.1.6 J6 GND

J6 is the return connection of the converter. A load can be connected between J6 and J4 (VOUT).

## 3.2 Jumpers and Switches

### 3.2.1 JP1 ENABLE

This jumper enables/disables the converter on the EVM. Placing a shorting bar between ENABLE and ON turns on the converter. Placing a shorting bar between ENABLE and OFF disables the converter.

### 3.2.2 JP2 MODE

This jumper enables/disables the power-saving mode under light loads. Placing a shorting bar between MODE and PWM disables the power-saving mode. If the power-save mode is disabled, the converter operates in forced PWM mode over the entire load current range.

Placing a shorting bar between MODE and PSM enables the power-saving mode. The device operates in power-saving mode under light load conditions. See the specific device data sheet for detailed information.

## 4 Test Configuration

### 4.1 Hardware Setup

Figure 2 illustrates a typical hardware test configuration.

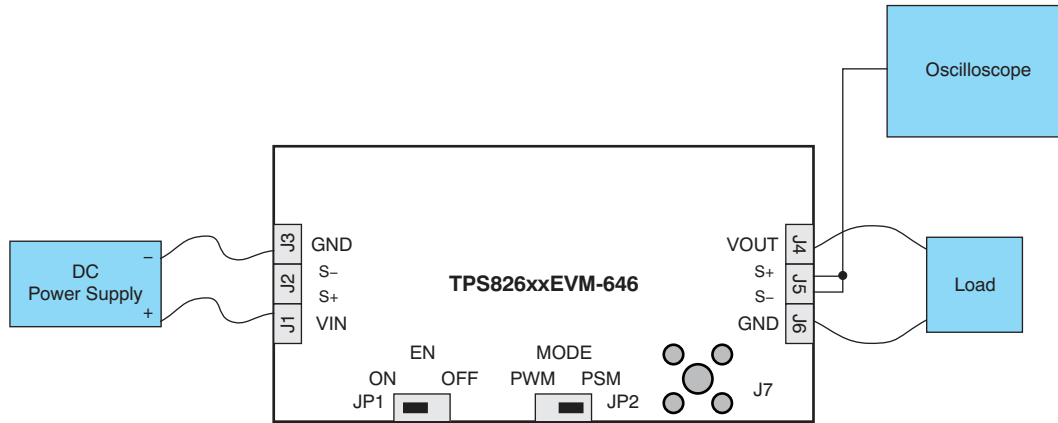

**Figure 2. Hardware Board Connection**

### 4.2 Procedure

Follow these procedures when configuring the EVM for testing.

#### CAUTION

Many of the components on the TPS826xxEVM-646 are susceptible to damage by electrostatic discharge (ESD). Customers are advised to observe proper ESD handling precautions when unpacking and handling the EVM, including the use of a grounded wrist strap, bootstraps, or mats at an approved ESD workstation. An electrostatic smock and safety glasses should also be worn.

1. Work at an ESD workstation. Make sure that any wrist straps, bootstraps, or mats are connected and reference the user to earth ground before power is applied to the EVM. Electrostatic smocks and safety glasses should also be worn.
2. Connect a dc power supply between J1 and J2 on the TPS826xxEVM. Note that the input voltage should range from 2.3 V to 4.8 V. Keep the wires from the input power supply to EVM as short as possible and twisted.
3. Connect a dc voltmeter or oscilloscope to the output sense connection of the EVM.
4. A load can be connected between J4 and J6 on the TPS826xxEVM.
5. To enable the converter, connect the shorting bar on JP1 between ENABLE and ON on the TPS826xxEVM.
6. The TPS826xxEVM has a feature that allows users to switch between Power-Save Mode under light loads and forced PWM mode, with jumper JP2.

## 5 TPS826xxEVM Test Data

This section presents typical performance data for the TPS826xxEVM. Actual performance data can be affected by measurement techniques and environmental variables; therefore, these results are presented for reference and may differ from actual results obtained by some users.

### 5.1 Thermal Performance

Figure 3 and Figure 4 show the typical thermal performance for the TPS826xx for both the top side and the bottom side, respectively.

#### 5.1.1 Top Side

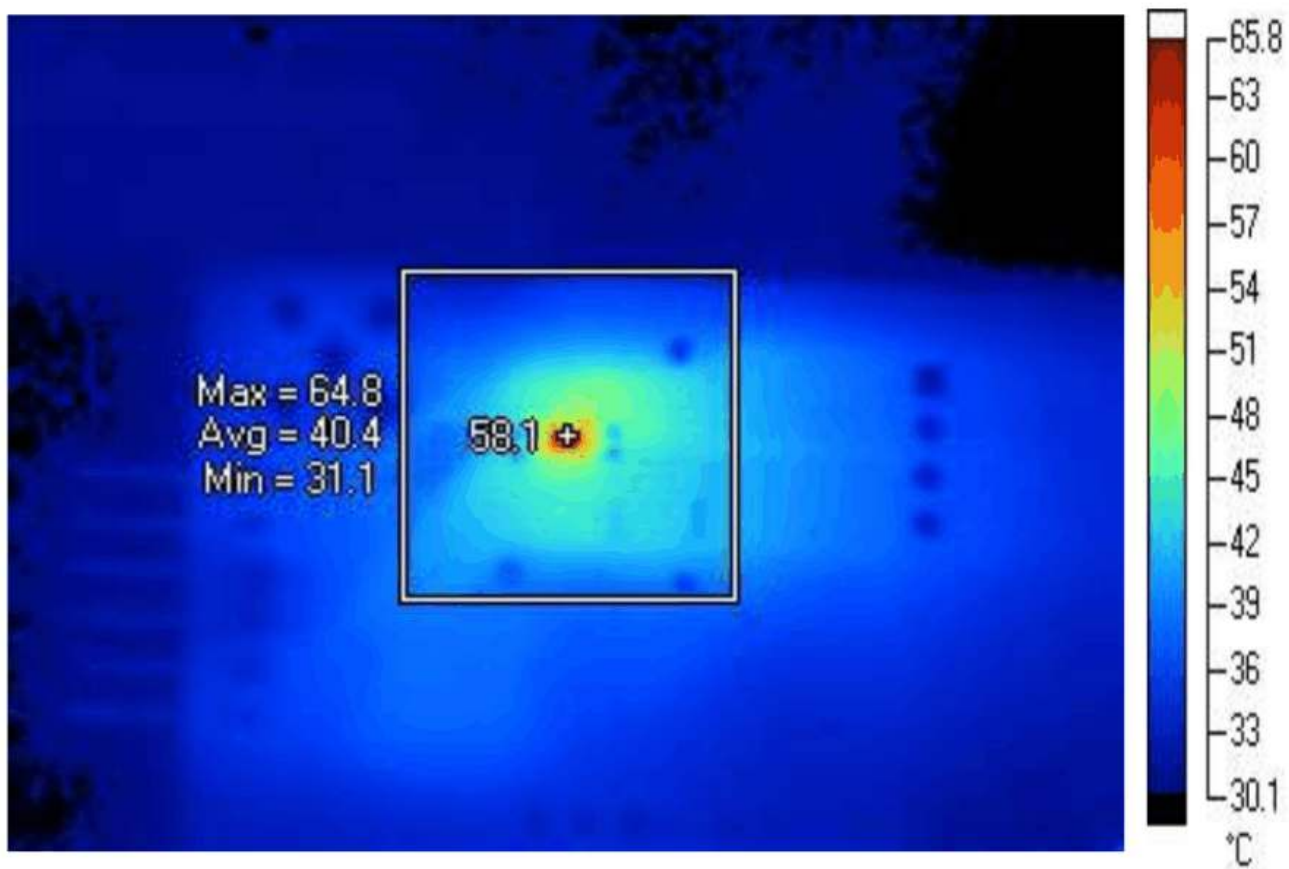

**Figure 3. Top Side Thermal Measurement**

5.1.2 Bottom Side

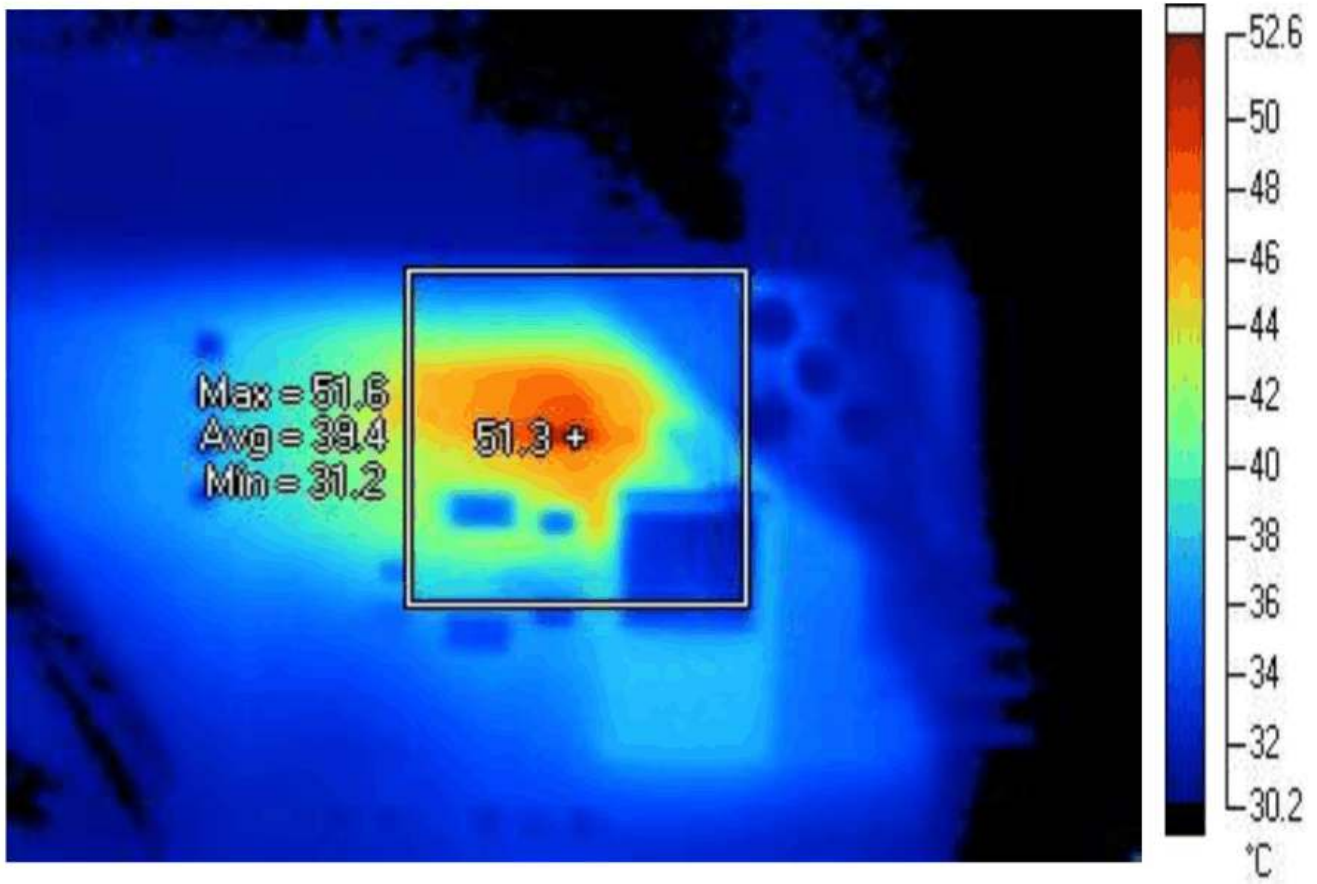

Figure 4. Bottom Side Thermal Measurement

## 6 TPS826xxEVM Assembly Drawings and Layout

Figure 5 through Figure 7 show the design of the show the design of the TPS826xxEVM-646 printed circuit boards. The EVM has been designed using a two-layer, 1-ounce copper-clad PCB with all components in an active area on the top side of the board. Moving components to both sides of the PCB or using additional internal layers can offer additional size reduction for space-constrained systems.

**NOTE:** Board layouts are not to scale. These figures are intended to show how the board is laid out; they are not intended to be used for manufacturing TPS826xxEVM-646 PCBs.

Note the connection of the TPS8267x feedback (FB) pin. It is recommended to connect the FB pin directly to the inductor, not directly on the  $V_{OUT}$  connection of the output capacitor. The connection to the inductor is recommended because it provides better transient response performance.

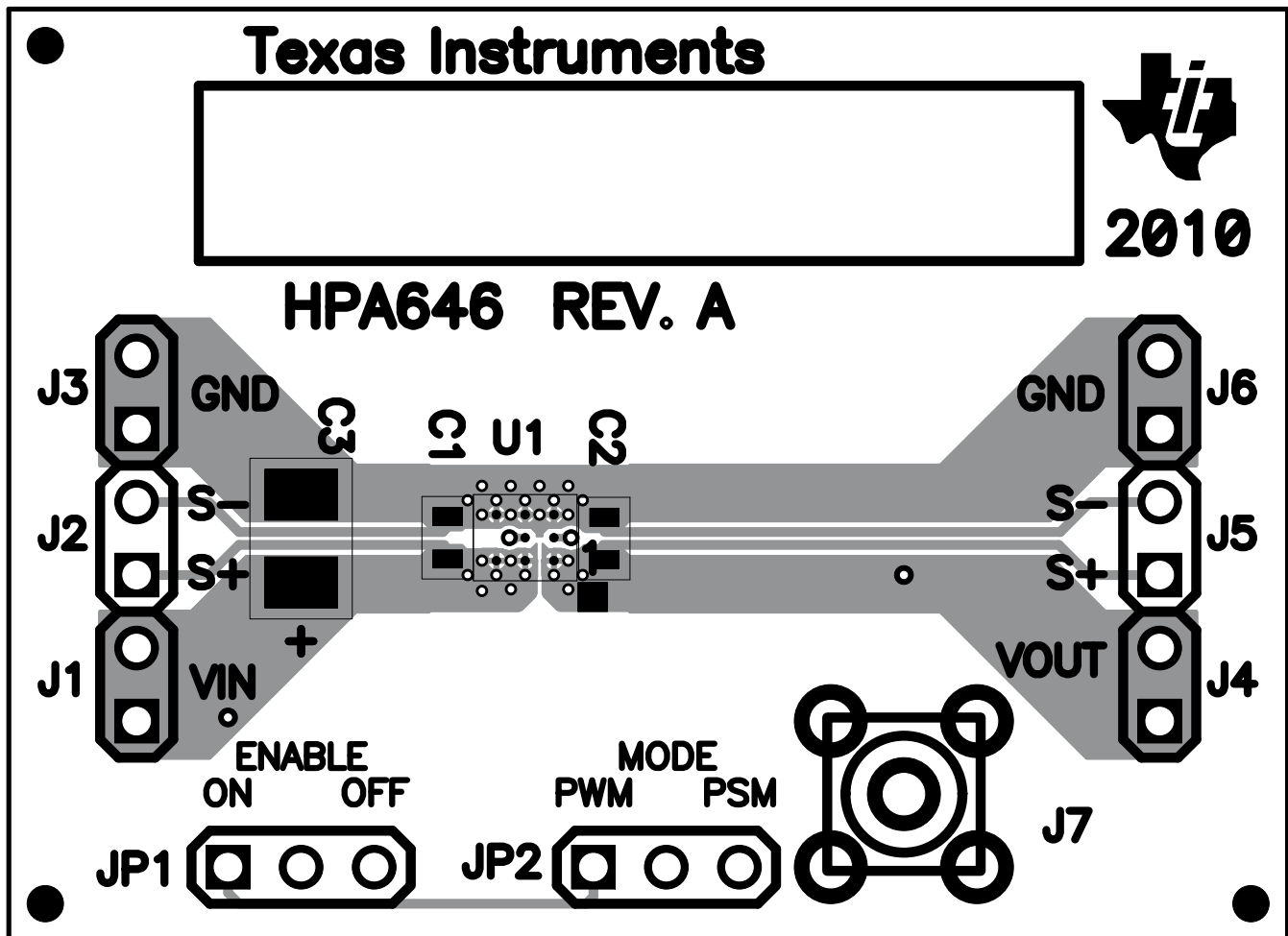

Figure 5. TPS826xxEVM Component Placement (Top View)



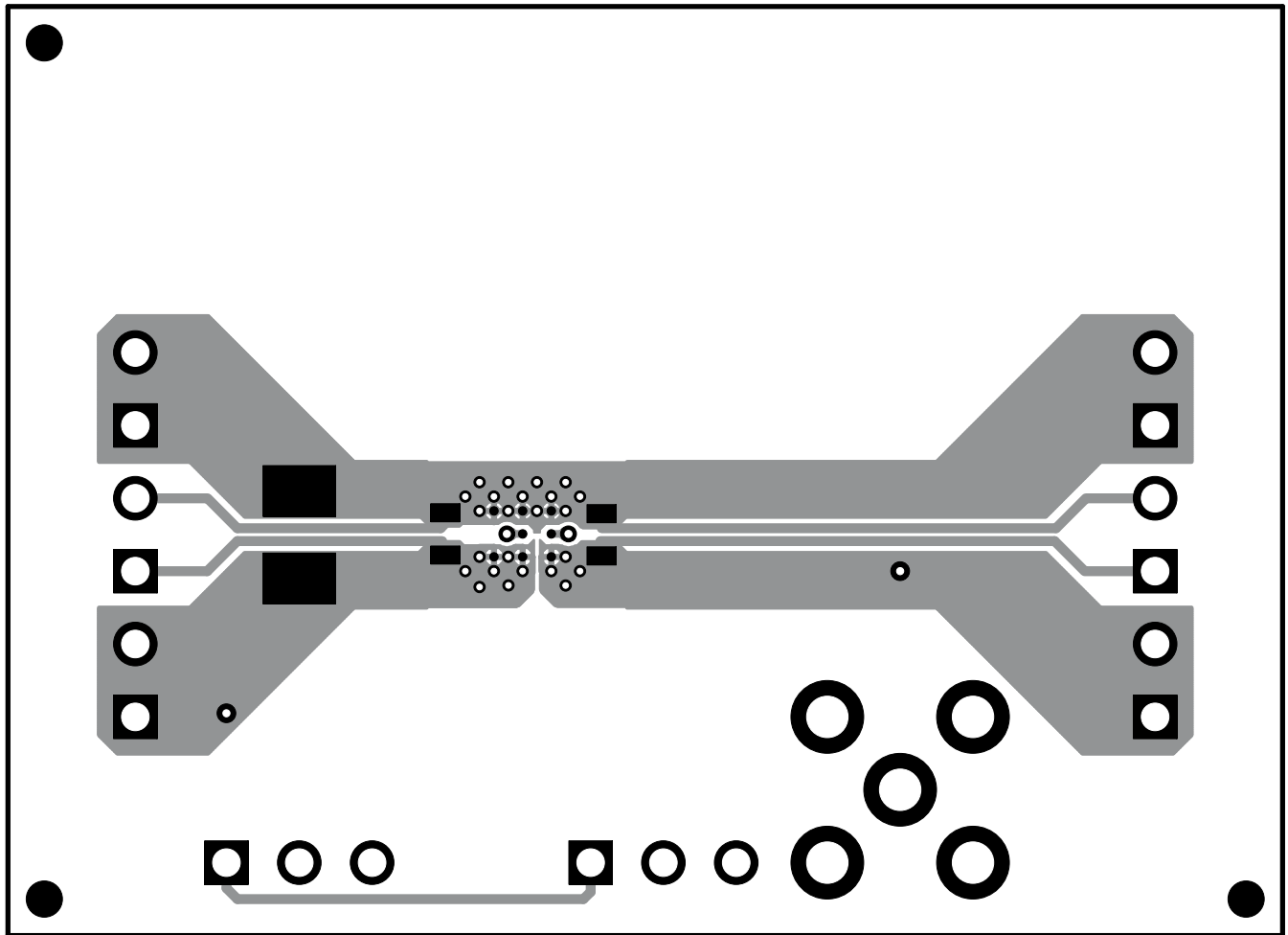
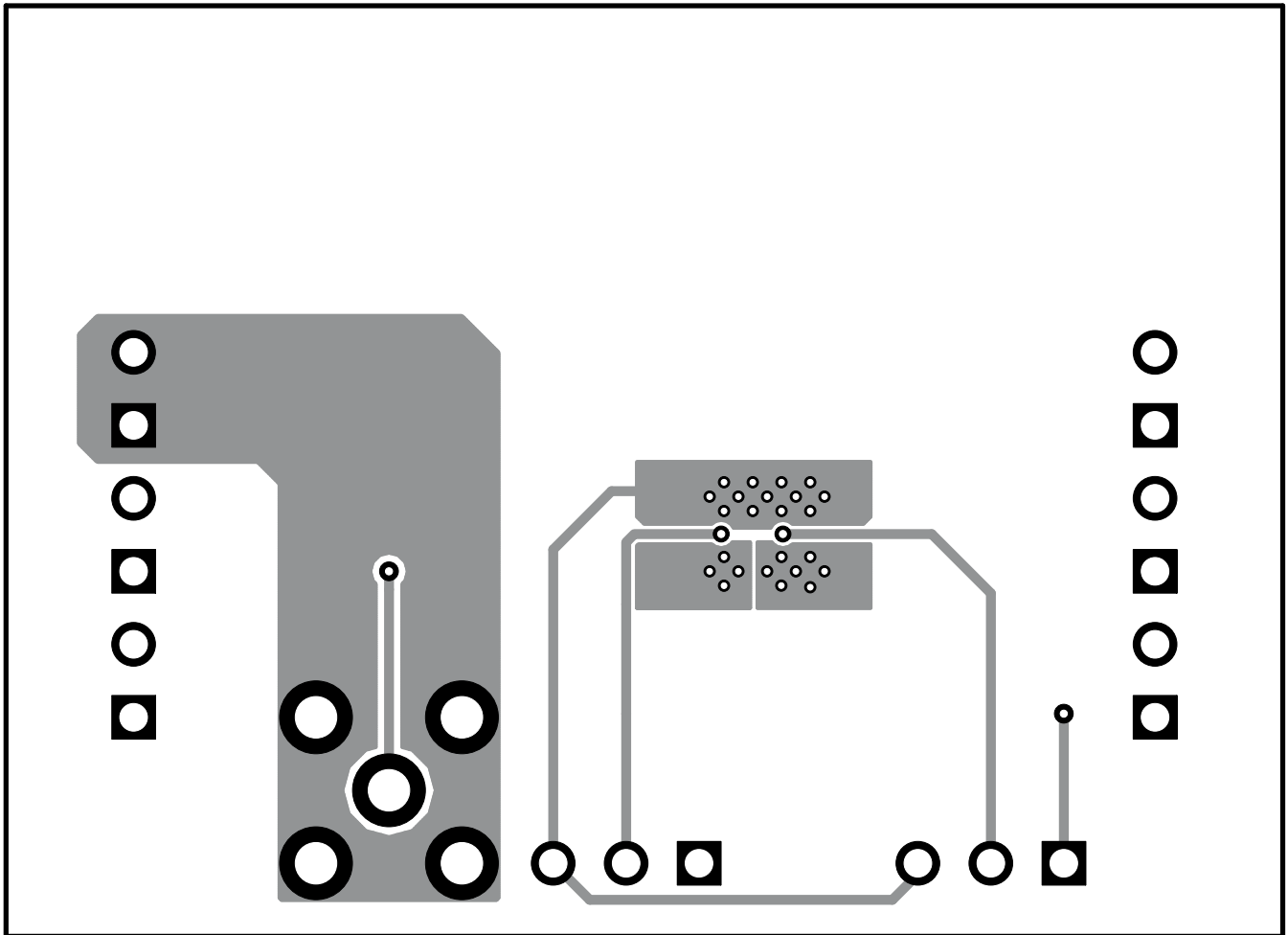

Figure 6. TPS826xxEVM Top-Side Copper (Top View)



**Figure 7. TPS826xxEVM Bottom-Side Copper (Bottom View)**

## 7 Bill of Materials

Table 2 lists the bill of materials for the TPS826xxEVM.

**Table 2. TPS826xxEVM-646 Bill of Materials**

EVM Device Option: Count					RefDes	Value	Description	Size	Part Number	Mfr
-001	-002	-003	-004	-005						
0	0	0	0	0	C1, C2	Open	Capacitor, Ceramic	0603	Std	Std
1	1	1	1	1	C3	150 $\mu$ F	Capacitor, Tantalum, 6.3 V, 70 m $\Omega$ , 20%	3528(B)	T520B157M006ATE070	Kemet
0	0	0	0	0	J7	Open	Connector, SMA , Straight, PC mount	0.210 in <sup>2</sup>	901-144-8RFX	AMP
1	0	0	0	0	U1	TPS82671SIP	IC, 600-mA, High-Freq $\mu$ Module Step-Down Converter	SIP-8	TPS82671SIP	TI
0	1	0	0	0	U1	TPS82675SIP	IC, 600-mA, High-Freq $\mu$ Module Step-Down Converter	SIP-8	TPS82675SIP	TI
0	0	1	0	0	U1	TPS82690SIP	IC, 500-mA, High-Freq $\mu$ Module Step-Down Converter	SIP-8	TPS82690SIP	TI
0	0	0	1	0	U1	TPS82695SIP	IC, 500-mA, High-Freq $\mu$ Module Step-Down Converter	SIP-8	TPS82695SIP	TI
0	0	0	0	1	U1	TPS82672SIP	IC, 600-mA, High-Freq $\mu$ Module Step-Down Converter	SIP-8	TPS82672SIP	TI

## 8 Marking Information

Table 3 provides the marking information for this EVM.

**Table 3. Marking Information**

Assembly Number	Marking Text
HPA646-001	TPS82671EVM-646
HPA646-002	TPS82675EVM-646
HPA646-003	TPS82690EVM-646
HPA646-004	TPS82695EVM-646
HPA646-005	TPS82672EVM-646

## Revision History

### Changes from C Revision (June, 2011) to D Revision Page

- Added column for -005 option to [Table 2](#) ..... 11

NOTE: Page numbers for previous revisions may differ from page numbers in the current version.

## Evaluation Board/Kit Important Notice

Texas Instruments (TI) provides the enclosed product(s) under the following conditions:

This evaluation board/kit is intended for use for **ENGINEERING DEVELOPMENT, DEMONSTRATION, OR EVALUATION PURPOSES ONLY** and is not considered by TI to be a finished end-product fit for general consumer use. Persons handling the product(s) must have electronics training and observe good engineering practice standards. As such, the goods being provided are not intended to be complete in terms of required design-, marketing-, and/or manufacturing-related protective considerations, including product safety and environmental measures typically found in end products that incorporate such semiconductor components or circuit boards. This evaluation board/kit does not fall within the scope of the European Union directives regarding electromagnetic compatibility, restricted substances (RoHS), recycling (WEEE), FCC, CE or UL, and therefore may not meet the technical requirements of these directives or other related directives.

Should this evaluation board/kit not meet the specifications indicated in the User's Guide, the board/kit may be returned within 30 days from the date of delivery for a full refund. **THE FOREGOING WARRANTY IS THE EXCLUSIVE WARRANTY MADE BY SELLER TO BUYER AND IS IN LIEU OF ALL OTHER WARRANTIES, EXPRESSED, IMPLIED, OR STATUTORY, INCLUDING ANY WARRANTY OF MERCHANTABILITY OR FITNESS FOR ANY PARTICULAR PURPOSE.**

The user assumes all responsibility and liability for proper and safe handling of the goods. Further, the user indemnifies TI from all claims arising from the handling or use of the goods. Due to the open construction of the product, it is the user's responsibility to take any and all appropriate precautions with regard to electrostatic discharge.

**EXCEPT TO THE EXTENT OF THE INDEMNITY SET FORTH ABOVE, NEITHER PARTY SHALL BE LIABLE TO THE OTHER FOR ANY INDIRECT, SPECIAL, INCIDENTAL, OR CONSEQUENTIAL DAMAGES.**

TI currently deals with a variety of customers for products, and therefore our arrangement with the user **is not exclusive.**

TI assumes **no liability for applications assistance, customer product design, software performance, or infringement of patents or services described herein.**

Please read the User's Guide and, specifically, the Warnings and Restrictions notice in the User's Guide prior to handling the product. This notice contains important safety information about temperatures and voltages. For additional information on TI's environmental and/or safety programs, please contact the TI application engineer or visit [www.ti.com/esh](http://www.ti.com/esh).

No license is granted under any patent right or other intellectual property right of TI covering or relating to any machine, process, or combination in which such TI products or services might be or are used.

## FCC Warning

This evaluation board/kit is intended for use for **ENGINEERING DEVELOPMENT, DEMONSTRATION, OR EVALUATION PURPOSES ONLY** and is not considered by TI to be a finished end-product fit for general consumer use. It generates, uses, and can radiate radio frequency energy and has not been tested for compliance with the limits of computing devices pursuant to part 15 of FCC rules, which are designed to provide reasonable protection against radio frequency interference. Operation of this equipment in other environments may cause interference with radio communications, in which case the user at his own expense will be required to take whatever measures may be required to correct this interference.

## EVM Warnings and Restrictions

It is important to operate this EVM within the input voltage range of 1.8 V to 4.8 V and the output voltage range of 1.2 V to 1.8 V.

Exceeding the specified input range may cause unexpected operation and/or irreversible damage to the EVM. If there are questions concerning the input range, please contact a TI field representative prior to connecting the input power.

Applying loads outside of the specified output range may result in unintended operation and/or possible permanent damage to the EVM. Please consult the EVM User's Guide prior to connecting any load to the EVM output. If there is uncertainty as to the load specification, please contact a TI field representative.

During normal operation, some circuit components may have case temperatures greater than +60°C. The EVM is designed to operate properly with certain components above +60°C as long as the input and output ranges are maintained. These components include but are not limited to linear regulators, switching transistors, pass transistors, and current sense resistors. These types of devices can be identified using the EVM schematic located in the EVM User's Guide. When placing measurement probes near these devices during operation, please be aware that these devices may be very warm to the touch.

Mailing Address: Texas Instruments, Post Office Box 655303, Dallas, Texas 75265  
Copyright © 2011, Texas Instruments Incorporated

## IMPORTANT NOTICE

Texas Instruments Incorporated and its subsidiaries (TI) reserve the right to make corrections, modifications, enhancements, improvements, and other changes to its products and services at any time and to discontinue any product or service without notice. Customers should obtain the latest relevant information before placing orders and should verify that such information is current and complete. All products are sold subject to TI's terms and conditions of sale supplied at the time of order acknowledgment.

TI warrants performance of its hardware products to the specifications applicable at the time of sale in accordance with TI's standard warranty. Testing and other quality control techniques are used to the extent TI deems necessary to support this warranty. Except where mandated by government requirements, testing of all parameters of each product is not necessarily performed.

TI assumes no liability for applications assistance or customer product design. Customers are responsible for their products and applications using TI components. To minimize the risks associated with customer products and applications, customers should provide adequate design and operating safeguards.

TI does not warrant or represent that any license, either express or implied, is granted under any TI patent right, copyright, mask work right, or other TI intellectual property right relating to any combination, machine, or process in which TI products or services are used. Information published by TI regarding third-party products or services does not constitute a license from TI to use such products or services or a warranty or endorsement thereof. Use of such information may require a license from a third party under the patents or other intellectual property of the third party, or a license from TI under the patents or other intellectual property of TI.

Reproduction of TI information in TI data books or data sheets is permissible only if reproduction is without alteration and is accompanied by all associated warranties, conditions, limitations, and notices. Reproduction of this information with alteration is an unfair and deceptive business practice. TI is not responsible or liable for such altered documentation. Information of third parties may be subject to additional restrictions.

Resale of TI products or services with statements different from or beyond the parameters stated by TI for that product or service voids all express and any implied warranties for the associated TI product or service and is an unfair and deceptive business practice. TI is not responsible or liable for any such statements.

TI products are not authorized for use in safety-critical applications (such as life support) where a failure of the TI product would reasonably be expected to cause severe personal injury or death, unless officers of the parties have executed an agreement specifically governing such use. Buyers represent that they have all necessary expertise in the safety and regulatory ramifications of their applications, and acknowledge and agree that they are solely responsible for all legal, regulatory and safety-related requirements concerning their products and any use of TI products in such safety-critical applications, notwithstanding any applications-related information or support that may be provided by TI. Further, Buyers must fully indemnify TI and its representatives against any damages arising out of the use of TI products in such safety-critical applications.

TI products are neither designed nor intended for use in military/aerospace applications or environments unless the TI products are specifically designated by TI as military-grade or "enhanced plastic." Only products designated by TI as military-grade meet military specifications. Buyers acknowledge and agree that any such use of TI products which TI has not designated as military-grade is solely at the Buyer's risk, and that they are solely responsible for compliance with all legal and regulatory requirements in connection with such use.

TI products are neither designed nor intended for use in automotive applications or environments unless the specific TI products are designated by TI as compliant with ISO/TS 16949 requirements. Buyers acknowledge and agree that, if they use any non-designated products in automotive applications, TI will not be responsible for any failure to meet such requirements.

Following are URLs where you can obtain information on other Texas Instruments products and application solutions:

### Products

Audio	<a href="http://www.ti.com/audio">www.ti.com/audio</a>
Amplifiers	<a href="http://amplifier.ti.com">amplifier.ti.com</a>
Data Converters	<a href="http://dataconverter.ti.com">dataconverter.ti.com</a>
DLP® Products	<a href="http://www.dlp.com">www.dlp.com</a>
DSP	<a href="http://dsp.ti.com">dsp.ti.com</a>
Clocks and Timers	<a href="http://www.ti.com/clocks">www.ti.com/clocks</a>
Interface	<a href="http://interface.ti.com">interface.ti.com</a>
Logic	<a href="http://logic.ti.com">logic.ti.com</a>
Power Mgmt	<a href="http://power.ti.com">power.ti.com</a>
Microcontrollers	<a href="http://microcontroller.ti.com">microcontroller.ti.com</a>
RFID	<a href="http://www.ti-rfid.com">www.ti-rfid.com</a>
OMAP Mobile Processors	<a href="http://www.ti.com/omap">www.ti.com/omap</a>
Wireless Connectivity	<a href="http://www.ti.com/wirelessconnectivity">www.ti.com/wirelessconnectivity</a>

### Applications

Communications and Telecom	<a href="http://www.ti.com/communications">www.ti.com/communications</a>
Computers and Peripherals	<a href="http://www.ti.com/computers">www.ti.com/computers</a>
Consumer Electronics	<a href="http://www.ti.com/consumer-apps">www.ti.com/consumer-apps</a>
Energy and Lighting	<a href="http://www.ti.com/energy">www.ti.com/energy</a>
Industrial	<a href="http://www.ti.com/industrial">www.ti.com/industrial</a>
Medical	<a href="http://www.ti.com/medical">www.ti.com/medical</a>
Security	<a href="http://www.ti.com/security">www.ti.com/security</a>
Space, Avionics and Defense	<a href="http://www.ti.com/space-avionics-defense">www.ti.com/space-avionics-defense</a>
Transportation and Automotive	<a href="http://www.ti.com/automotive">www.ti.com/automotive</a>
Video and Imaging	<a href="http://www.ti.com/video">www.ti.com/video</a>

TI E2E Community Home Page

[e2e.ti.com](http://e2e.ti.com)

Mailing Address: Texas Instruments, Post Office Box 655303, Dallas, Texas 75265  
Copyright © 2011, Texas Instruments Incorporated