

UNIT:mm

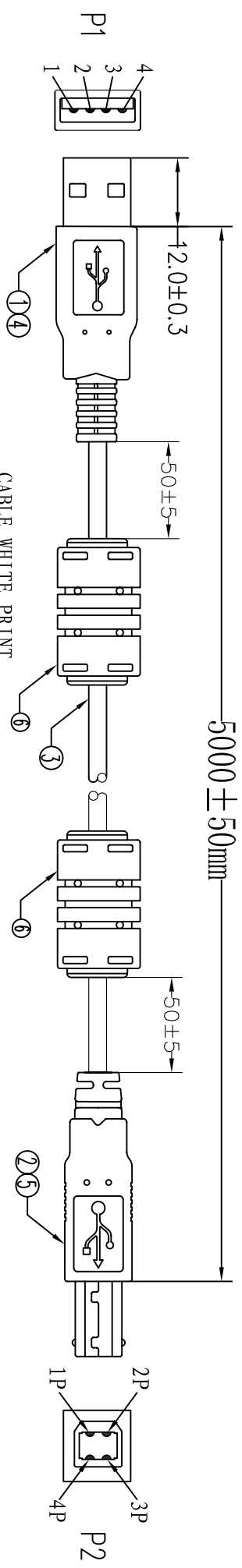

CABLE WHITE PRINT
 HI-SPEED USB Revision 2.0 SHIELDED 28AWG/1P+24AWG/2C
 E189529 AWM STYLE 2725 80° C 30V VW-1 VEGA TECH

PIN ASSIGNMENT :

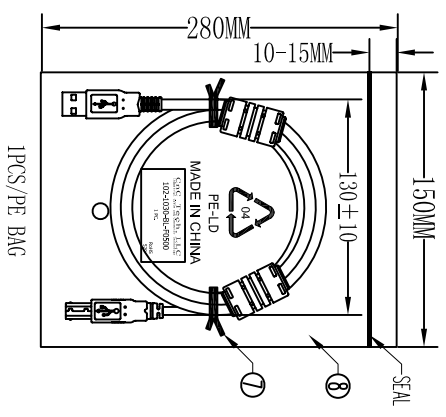
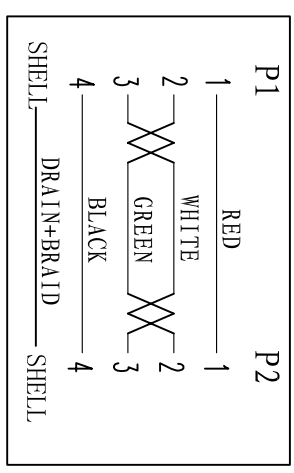

Electrical test:
 1. 100% short, open, miswire test
 2. Conduct resistance: 5 Ohm(max)
 3. Insulation resistance: 5Mohm(min)
 4. dielectric test: DC 300V

⑨	PE BAG	1/10	CLEAR SIZE:360*380*0.05mm PRINT BLACK"MADE IN CHINA"+"10PCS".
⑩	PE BAG	1	CLEAR SIZE:150*280*0.05mm PRINT BLACK"MADE IN CHINA"+"1PC".
⑦	TIE	2	BLACK L=100mm
⑥	OUT JACKET	14.5g	BLACK 45P PVC (MOLD NO:CH003)
	FERRITE	2	CORE OD12*5.6*L20 BLACK
⑤	OUT JACKET	4.5g	BLACK PVC-40P (MOULD NO:WM-65)
④	OUT JACKET	5.0g	BLACK PVC-40P (MOULD NO:WM-40)
③	CABLE	1	BLACK USB2.0 UL2725 28#/1P+24#/2C+AEB OD:4.7mm L=5000±20mm
②	CONN	1set	USB2.0 B MALE SHELL:NICKEL PIN G/F 3PCS TYPE INSULATOR COLOR:WHITE
①	CONN	1set	USB2.0 A MALE SHELL:NICKEL PIN G/F 3PCS TYPE INSULATOR COLOR:WHITE
NO.	NAME	QTY	SPECIFICATION

CNC Tech, LLC
 Industrial Cable and Connector Technology

DRAWN	LI CHENG	DRAWING NO	
CHECKED		CUSTOMER	
APPROVAL		ITEM NO.	102-1030-BL-F0500
DECIDED		DATE	2012-11-22
VERSIONS/EDITION	A/0	PROJECTION	