

Trench gate field-stop IGBT, V series 600 V, 40 A very high speed

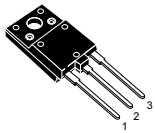

TO-3PF

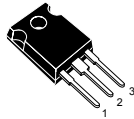

TO-247

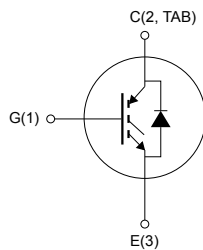

NG1E3C2T

Features

- Maximum junction temperature: $T_J = 175\text{ °C}$
- Tail-less switching off
- $V_{CE(sat)} = 1.8\text{ V (typ.) @ } I_C = 40\text{ A}$
- Tight parameters distribution
- Safe paralleling
- Low thermal resistance
- Very fast soft recovery antiparallel diode

Applications

- Welding
- Power factor correction
- UPS
- Solar inverters
- Chargers

Description

These devices are IGBTs developed using an advanced proprietary trench gate field-stop structure. These devices are part of the V series IGBTs, which represent an optimum compromise between conduction and switching losses to maximize the efficiency of very high frequency converters. Furthermore, the positive $V_{CE(sat)}$ temperature coefficient and very tight parameter distribution result in safer paralleling operation.



Product status links

[STGFW40V60DF](#)
[STGW40V60DF](#)

1 Electrical ratings

Table 1. Absolute maximum ratings

| Symbol | Parameter | Value | | Unit |
|----------------|---|------------|--------|------|
| | | TO-247 | TO-3PF | |
| V_{CES} | Collector-emitter voltage ($V_{GE} = 0$ V) | 600 | | V |
| I_C | Continuous collector current at $T_C = 25$ °C | 80 | | A |
| | Continuous collector current at $T_C = 100$ °C | 40 | | A |
| $I_{CP}^{(1)}$ | Pulsed collector current | 160 | | A |
| V_{GE} | Gate-emitter voltage | ±20 | | V |
| I_F | Continuous forward current at $T_C = 25$ °C | 80 | | A |
| | Continuous forward current at $T_C = 100$ °C | 40 | | A |
| $I_{FP}^{(1)}$ | Pulsed forward current | 160 | | A |
| P_{TOT} | Total power dissipation at $T_C = 25$ °C | 283 | 98.5 | W |
| V_{ISO} | Insulation withstand voltage (RMS) from all three leads to external heat sink ($t = 1$ s; $T_C = 25$ °C) | | 3.5 | kV |
| T_{stg} | Storage temperature range | -55 to 150 | | °C |
| T_J | Operating junction temperature range | -55 to 175 | | °C |

1. Pulse width is limited by maximum junction temperature.

Table 2. Thermal data

| Symbol | Parameter | Value | | Unit |
|------------|--|--------|--------|------|
| | | TO-247 | TO-3PF | |
| R_{thJC} | Thermal resistance, junction-to-case IGBT | 0.53 | 1.52 | °C/W |
| R_{thJC} | Thermal resistance, junction-to-case diode | 1.14 | 1.95 | °C/W |
| R_{thJA} | Thermal resistance, junction-to-ambient | 50 | | °C/W |

2 Electrical characteristics

$T_J = 25\text{ °C}$ unless otherwise specified

Table 3. Static characteristics

| Symbol | Parameter | Test conditions | Min. | Typ. | Max. | Unit |
|---------------|--------------------------------------|--|------|------|-----------|---------------|
| $V_{(BR)CES}$ | Collector-emitter breakdown voltage | $V_{GE} = 0\text{ V}, I_C = 2\text{ mA}$ | 600 | | | V |
| $V_{CE(sat)}$ | Collector-emitter saturation voltage | $V_{GE} = 15\text{ V}, I_C = 40\text{ A}$ | | 1.8 | 2.3 | V |
| | | $V_{GE} = 15\text{ V}, I_C = 40\text{ A}, T_J = 125\text{ °C}$ | | 2.15 | | |
| | | $V_{GE} = 15\text{ V}, I_C = 40\text{ A}, T_J = 175\text{ °C}$ | | 2.35 | | |
| V_F | Forward on-voltage | $I_F = 40\text{ A}$ | | 1.7 | 2.45 | V |
| | | $I_F = 40\text{ A}, T_J = 125\text{ °C}$ | | 1.4 | | |
| | | $I_F = 40\text{ A}, T_J = 175\text{ °C}$ | | 1.3 | | |
| $V_{GE(th)}$ | Gate threshold voltage | $V_{CE} = V_{GE}, I_C = 1\text{ mA}$ | 5 | 6 | 7 | V |
| I_{CES} | Collector cut-off current | $V_{GE} = 0\text{ V}, V_{CE} = 600\text{ V}$ | | | 25 | μA |
| I_{GES} | Gate-emitter leakage current | $V_{CE} = 0\text{ V}, V_{GE} = \pm 20\text{ V}$ | | | ± 250 | nA |

Table 4. Dynamic characteristics

| Symbol | Parameter | Test conditions | Min. | Typ. | Max. | Unit |
|-----------|------------------------------|---|------|------|------|------|
| C_{ies} | Input capacitance | $V_{CE} = 25\text{ V}, f = 1\text{ MHz}, V_{GE} = 0\text{ V}$ | - | 5400 | - | pF |
| C_{oes} | Output capacitance | | - | 220 | - | pF |
| C_{res} | Reverse transfer capacitance | | - | 180 | - | pF |
| Q_g | Total gate charge | $V_{CC} = 480\text{ V}, I_C = 40\text{ A}, V_{GE} = 0\text{ to }15\text{ V}$ (see Figure 34. Gate charge test circuit) | - | 226 | - | nC |
| Q_{ge} | Gate-emitter charge | | - | 38 | - | nC |
| Q_{gc} | Gate-collector charge | | - | 95 | - | nC |

Table 5. IGBT switching characteristics (inductive load)

| Symbol | Parameter | Test conditions | Min. | Typ. | Max. | Unit |
|-----------------|---------------------------|--|------|------|------|------------|
| $t_{d(on)}$ | Turn-on delay time | $V_{CE} = 400\text{ V}$, $I_C = 40\text{ A}$, $R_G = 10\ \Omega$, $V_{GE} = 15\text{ V}$ (see Figure 33. Test circuit for inductive load switching) | - | 52 | - | ns |
| t_r | Current rise time | | - | 17 | - | ns |
| $(di/dt)_{on}$ | Turn-on current slope | | - | 1850 | - | A/ μ s |
| $t_{d(off)}$ | Turn-off delay time | | - | 208 | - | ns |
| t_f | Current fall time | | - | 20 | - | ns |
| $E_{on}^{(1)}$ | Turn-on switching energy | | - | 456 | - | μ J |
| $E_{off}^{(2)}$ | Turn-off switching energy | | - | 411 | - | μ J |
| E_{ts} | Total switching energy | | - | 867 | - | μ J |
| $t_{d(on)}$ | Turn-on delay time | $V_{CE} = 400\text{ V}$, $I_C = 40\text{ A}$, $R_G = 10\ \Omega$, $V_{GE} = 15\text{ V}$, $T_J = 175\text{ }^\circ\text{C}$ (see Figure 33. Test circuit for inductive load switching) | - | 52 | - | ns |
| t_r | Current rise time | | - | 21 | - | ns |
| $(di/dt)_{on}$ | Turn-on current slope | | - | 1538 | - | A/ μ s |
| $t_{d(off)}$ | Turn-off-delay time | | - | 220 | - | ns |
| t_f | Current fall time | | - | 21 | - | ns |
| $E_{on}^{(1)}$ | Turn-on switching energy | | - | 1330 | - | μ J |
| $E_{off}^{(2)}$ | Turn-off switching energy | | - | 560 | - | μ J |
| E_{ts} | Total switching energy | | - | 1890 | - | μ J |

1. Including the reverse recovery of the diode.

2. Including the tail of the collector current.

Table 6. Diode switching characteristics (inductive load)

| Symbol | Parameter | Test conditions | Min. | Typ. | Max. | Unit |
|--------------|--|--|---|------|------|------------|
| t_{rr} | Reverse recovery time | $I_F = 40\text{ A}$, $V_R = 400\text{ V}$, $V_{GE} = 15\text{ V}$, $di/dt = 1000\text{ A}/\mu\text{s}$ (see Figure 33. Test circuit for inductive load switching) | - | 41 | - | ns |
| Q_{rr} | Reverse recovery charge | | - | 440 | - | nC |
| I_{rrm} | Reverse recovery current | | - | 21.6 | - | A |
| dI_{rr}/dt | Peak rate of fall of reverse recovery current during t_b | | - | 1363 | - | A/ μ s |
| E_{rr} | Reverse recovery energy | | - | 151 | - | μ J |
| t_{rr} | Reverse recovery time | | $I_F = 40\text{ A}$, $V_R = 400\text{ V}$, $V_{GE} = 15\text{ V}$, $di/dt = 1000\text{ A}/\mu\text{s}$, $T_J = 175\text{ }^\circ\text{C}$ (see Figure 33. Test circuit for inductive load switching) | - | 109 | - |
| Q_{rr} | Reverse recovery charge | - | | 2400 | - | nC |
| I_{rrm} | Reverse recovery current | - | | 44.4 | - | A |
| dI_{rr}/dt | Peak rate of fall of reverse recovery current during t_b | - | | 670 | - | A/ μ s |
| E_{rr} | Reverse recovery energy | - | | 718 | - | μ J |

2.1 Electrical characteristics (curves)

Figure 1. Power dissipation vs case temperature for TO-247

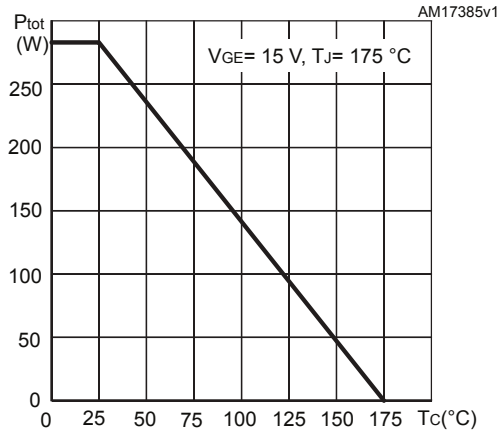

Figure 2. Collector current vs case temperature for TO-247

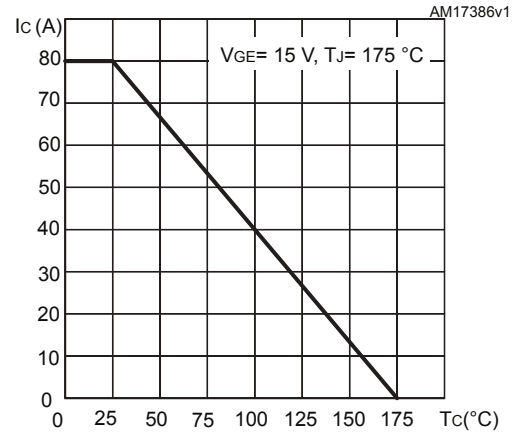

Figure 3. Power dissipation vs case temperature for TO-3PF

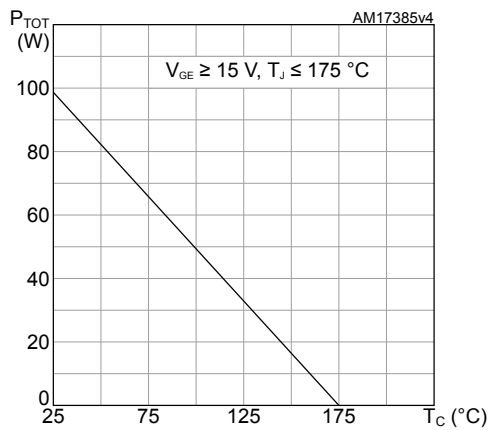

Figure 4. Collector current vs case temperature for TO-3PF

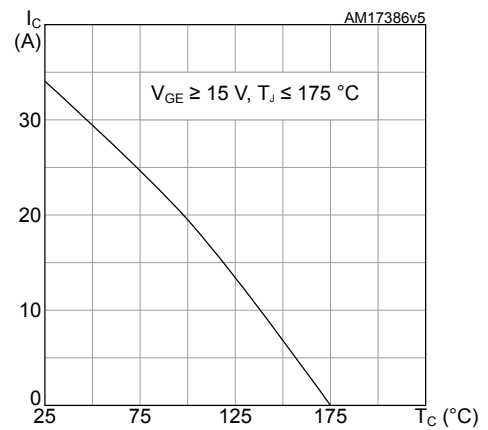

Figure 5. Output characteristics (T_J = 25 °C)

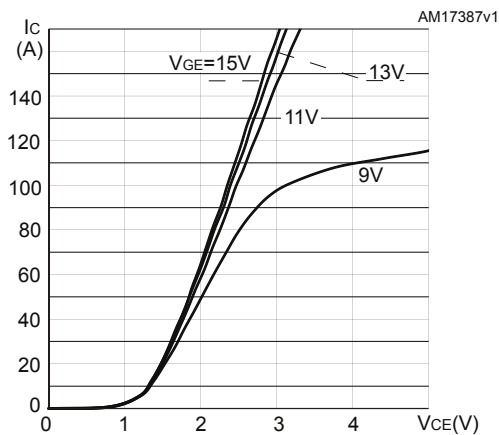

Figure 6. Output characteristics (T_J = 175 °C)

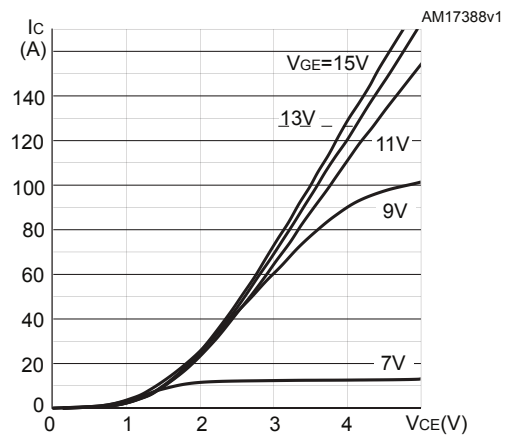

Figure 7. $V_{CE(sat)}$ vs junction temperature

Figure 8. $V_{CE(sat)}$ vs collector current

Figure 9. Collector current vs switching frequency for TO-247

Figure 10. Collector current vs switching frequency for TO-3PF

Figure 11. Forward bias safe operating area for TO-247

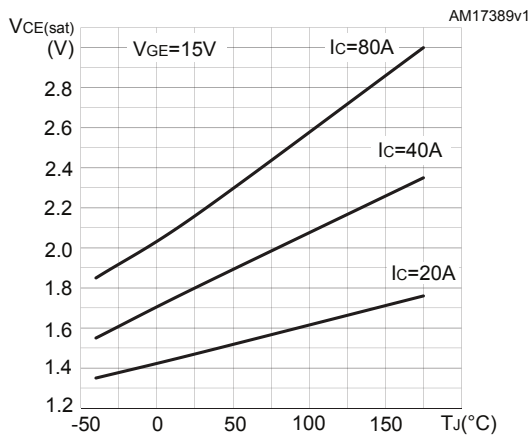
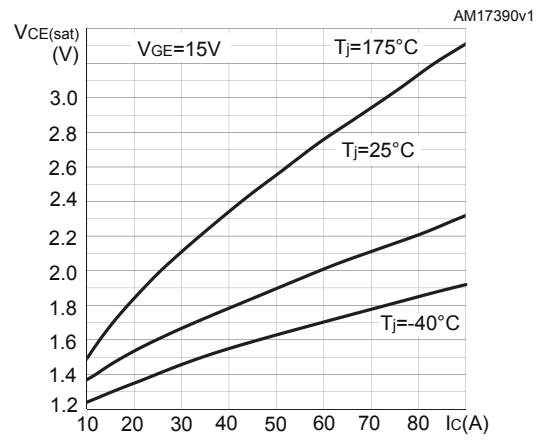
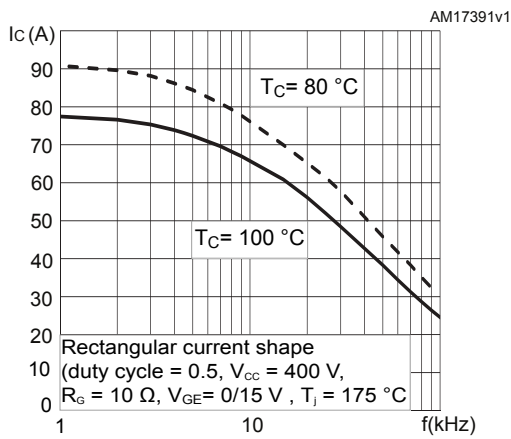
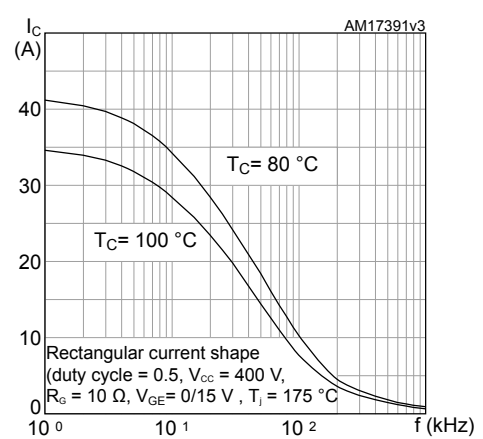
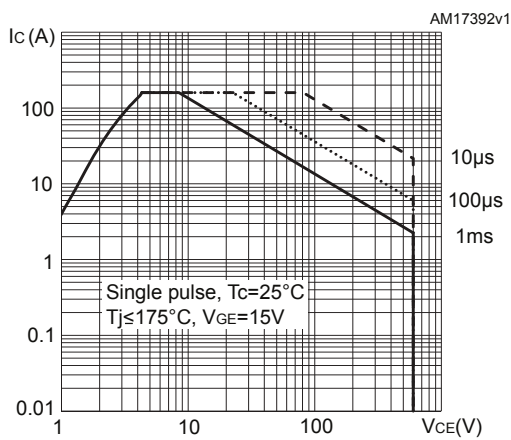
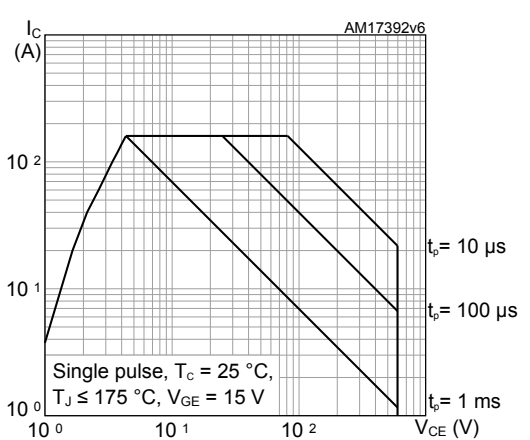
Figure 12. Forward bias safe operating area for TO-3PF

Figure 13. Transfer characteristics

Figure 14. Diode V_F vs forward current

Figure 15. Normalized $V_{GE(th)}$ vs junction temperature

Figure 16. Normalized $V_{(BR)CES}$ vs junction temperature

Figure 17. Capacitance variations

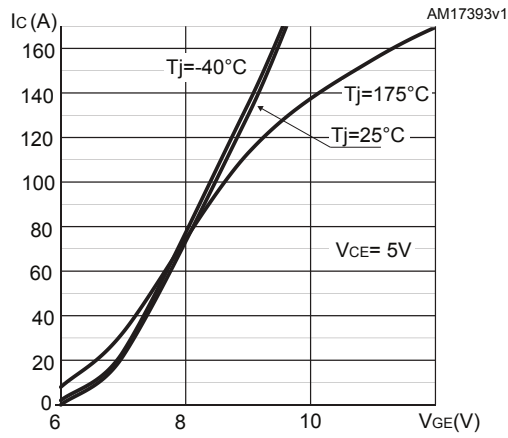
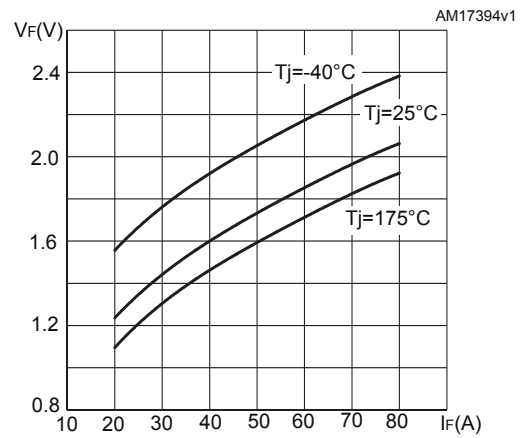
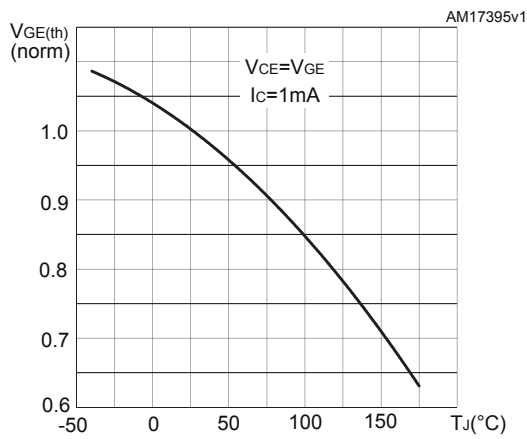
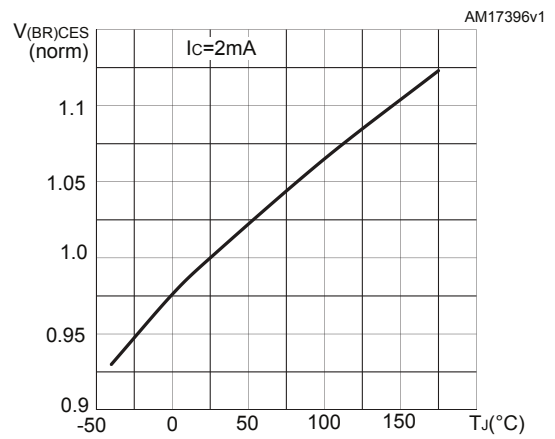
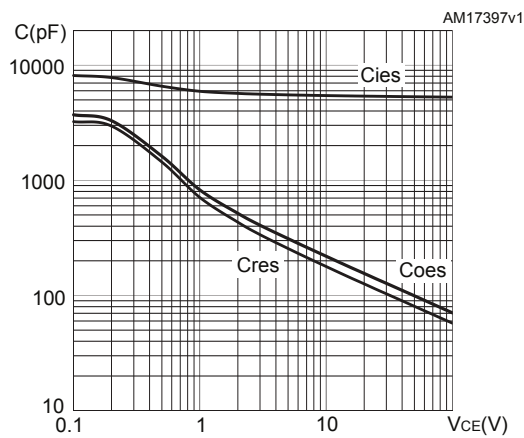
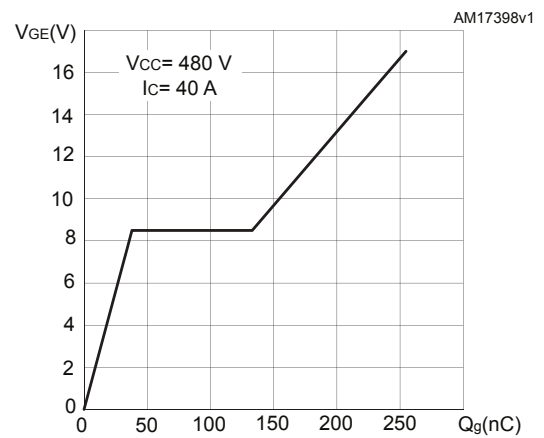
Figure 18. Gate charge vs gate-emitter voltage

Figure 19. Switching energy vs collector current

Figure 20. Switching energy vs gate resistance

Figure 21. Switching energy vs junction temperature

Figure 22. Switching energy vs collector emitter voltage

Figure 23. Switching times vs collector current

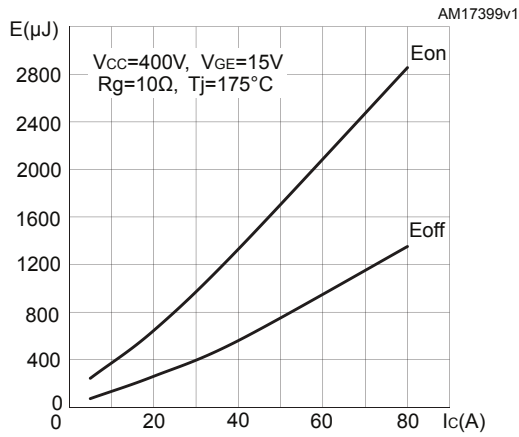
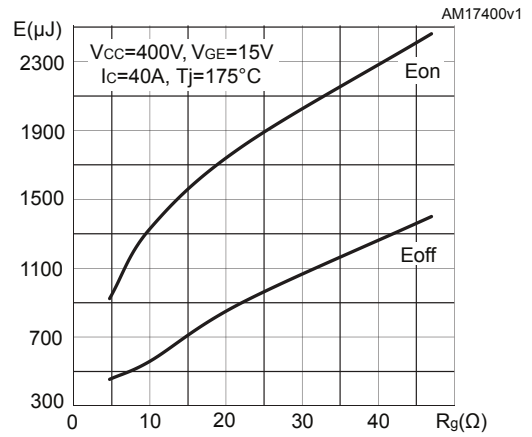
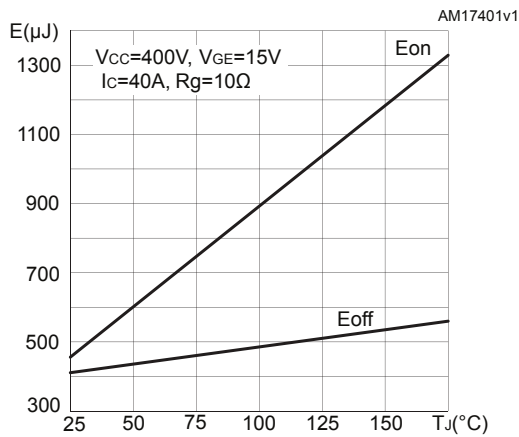
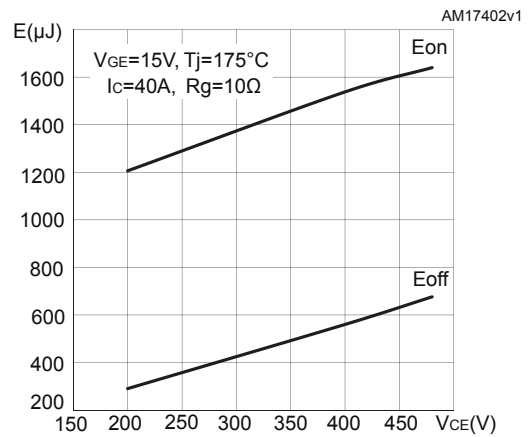
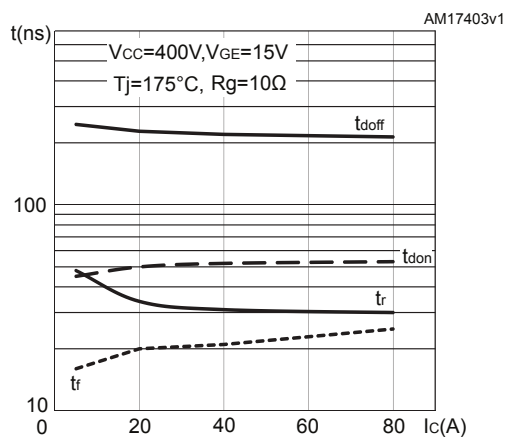
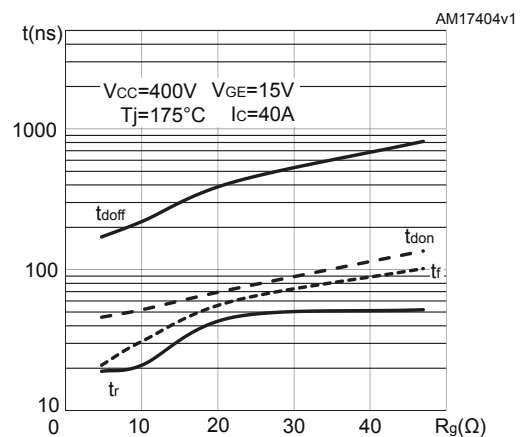
Figure 24. Switching times vs gate resistance

Figure 25. Reverse recovery current vs diode current slope

Figure 26. Reverse recovery time vs diode current slope

Figure 27. Reverse recovery charge vs diode current slope

Figure 28. Reverse recovery energy vs diode current slope

Figure 29. Thermal impedance for IGBT in TO-247

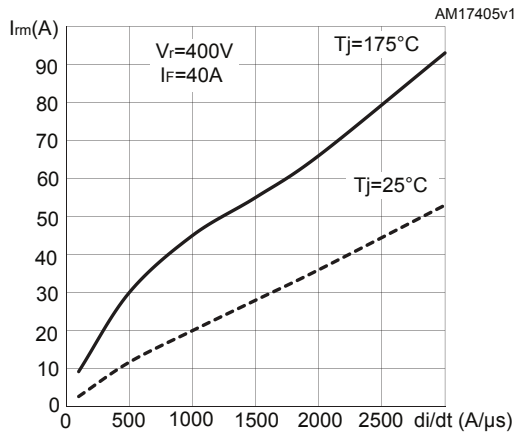
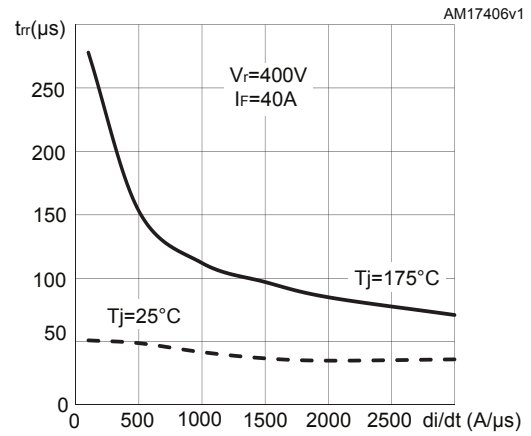
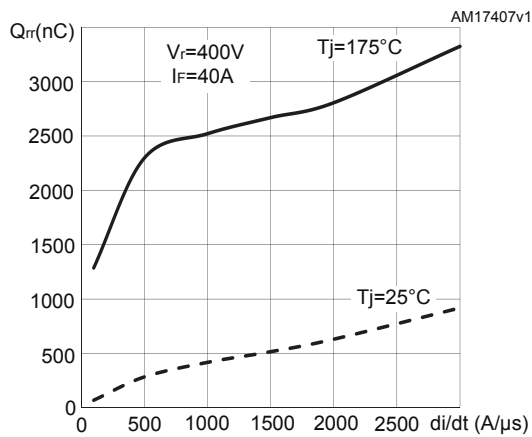
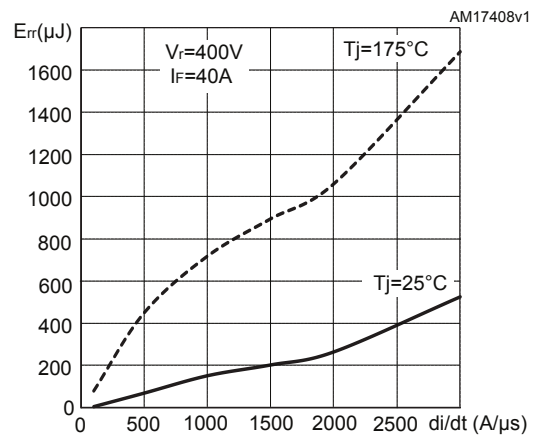
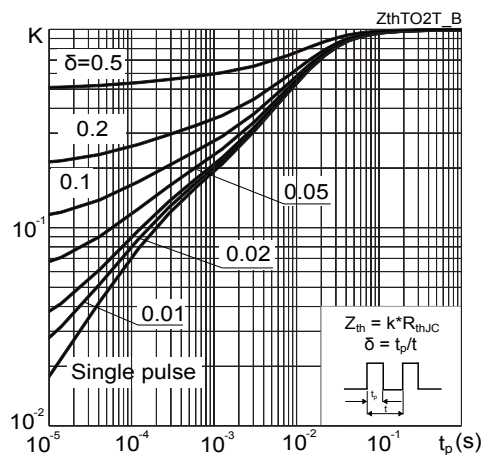
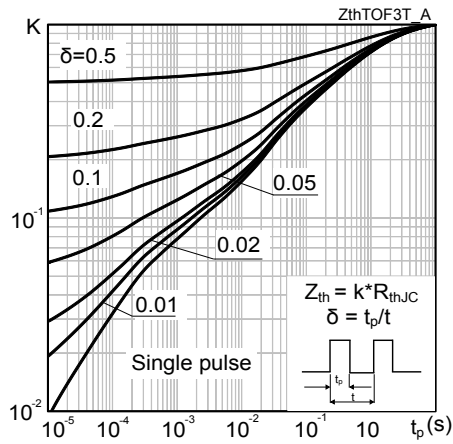
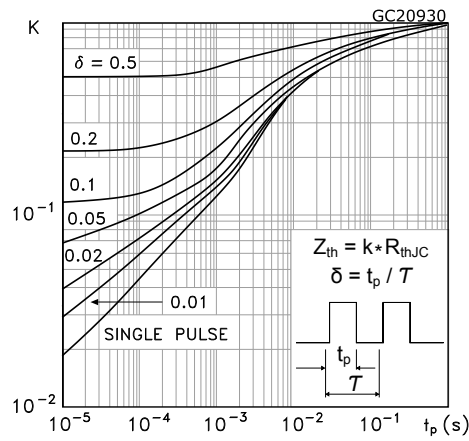
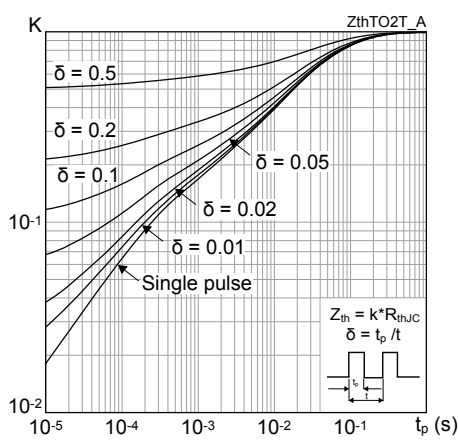
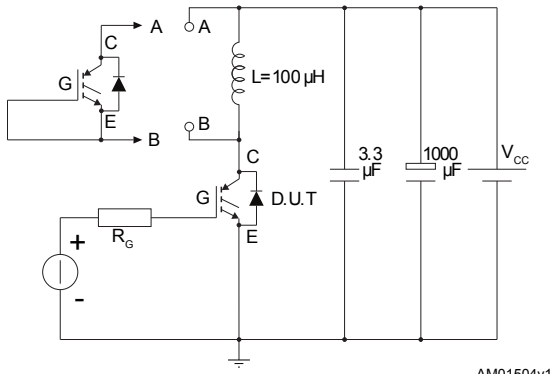
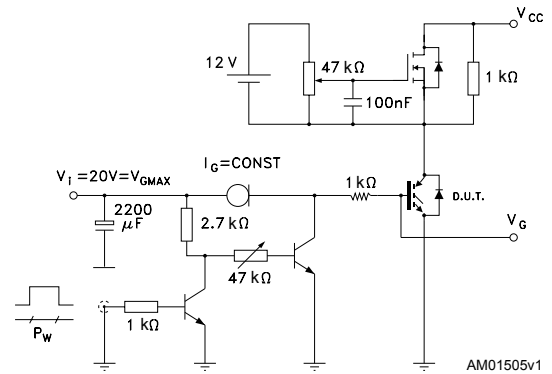
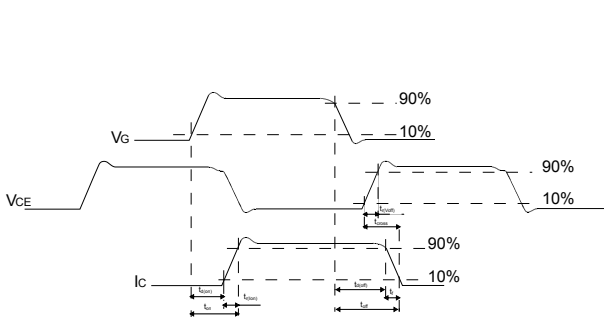
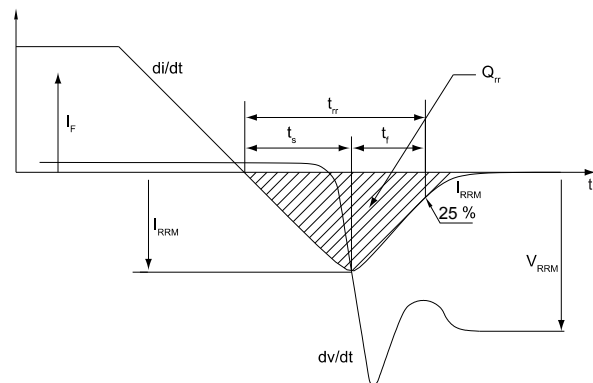
Figure 30. Thermal impedance for IGBT in TO-3PF

Figure 31. Thermal impedance for diode in TO-247

Figure 32. Thermal impedance for diode in TO-3PF

3 Test circuits

Figure 33. Test circuit for inductive load switching

Figure 34. Gate charge test circuit

Figure 35. Switching waveform

Figure 36. Diode reverse recovery waveform

4 Package information

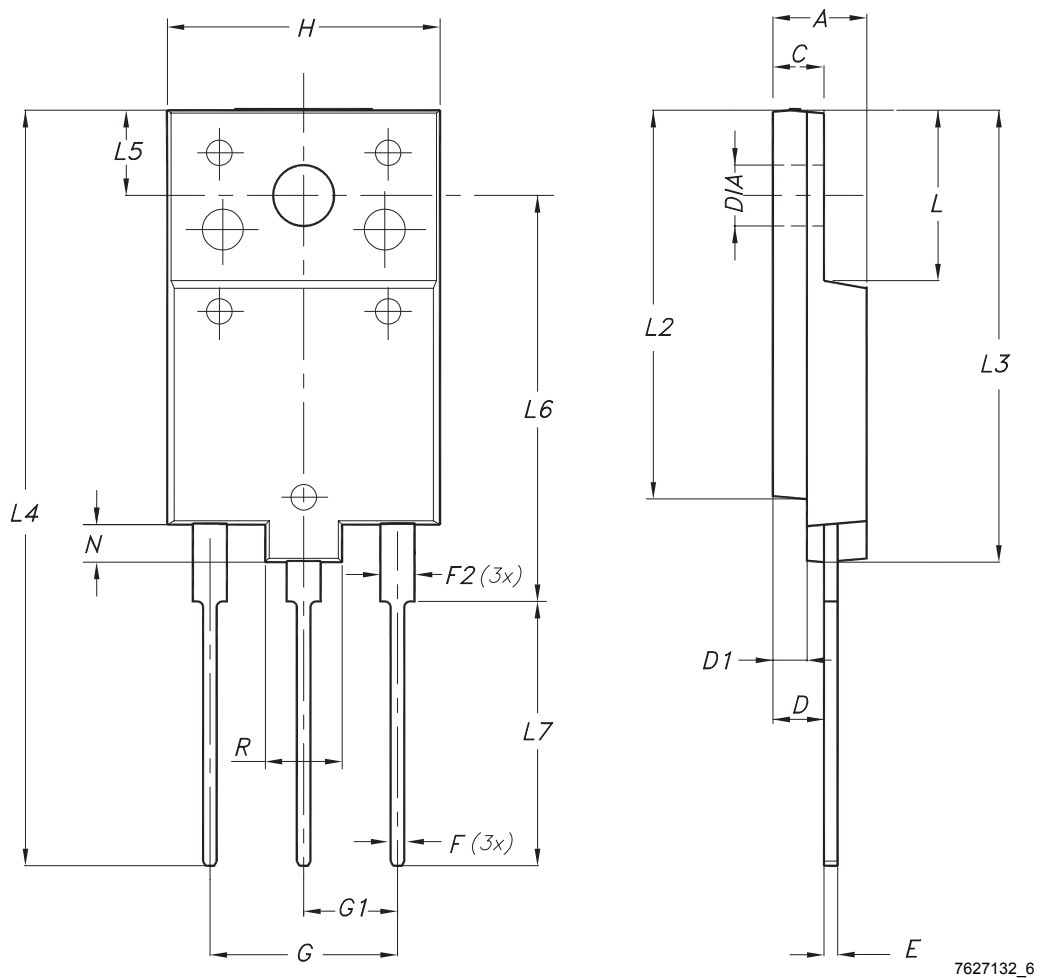
In order to meet environmental requirements, ST offers these devices in different grades of **ECOPACK** packages, depending on their level of environmental compliance. ECOPACK specifications, grade definitions and product status are available at: www.st.com. ECOPACK is an ST trademark.

4.1 TO-3PF package information

Figure 37. TO-3PF package outline



7627132_6

Table 7. TO-3PF mechanical data

| Dim. | mm | | |
|------|-------|-------|-------|
| | Min. | Typ. | Max. |
| A | 5.30 | | 5.70 |
| C | 2.80 | | 3.20 |
| D | 3.10 | | 3.50 |
| D1 | 1.80 | | 2.20 |
| E | 0.80 | | 1.10 |
| F | 0.65 | | 0.95 |
| F2 | 1.80 | | 2.20 |
| G | 10.30 | | 11.50 |
| G1 | | 5.45 | |
| H | 15.30 | | 15.70 |
| L | 9.80 | 10.00 | 10.20 |
| L2 | 22.80 | | 23.20 |
| L3 | 26.30 | | 26.70 |
| L4 | 43.20 | | 44.40 |
| L5 | 4.30 | | 4.70 |
| L6 | 24.30 | | 24.70 |
| L7 | 14.60 | | 15.00 |
| N | 1.80 | | 2.20 |
| R | 3.80 | | 4.20 |
| Dia | 3.40 | | 3.80 |

4.2 TO-247 package information

Figure 38. TO-247 package outline

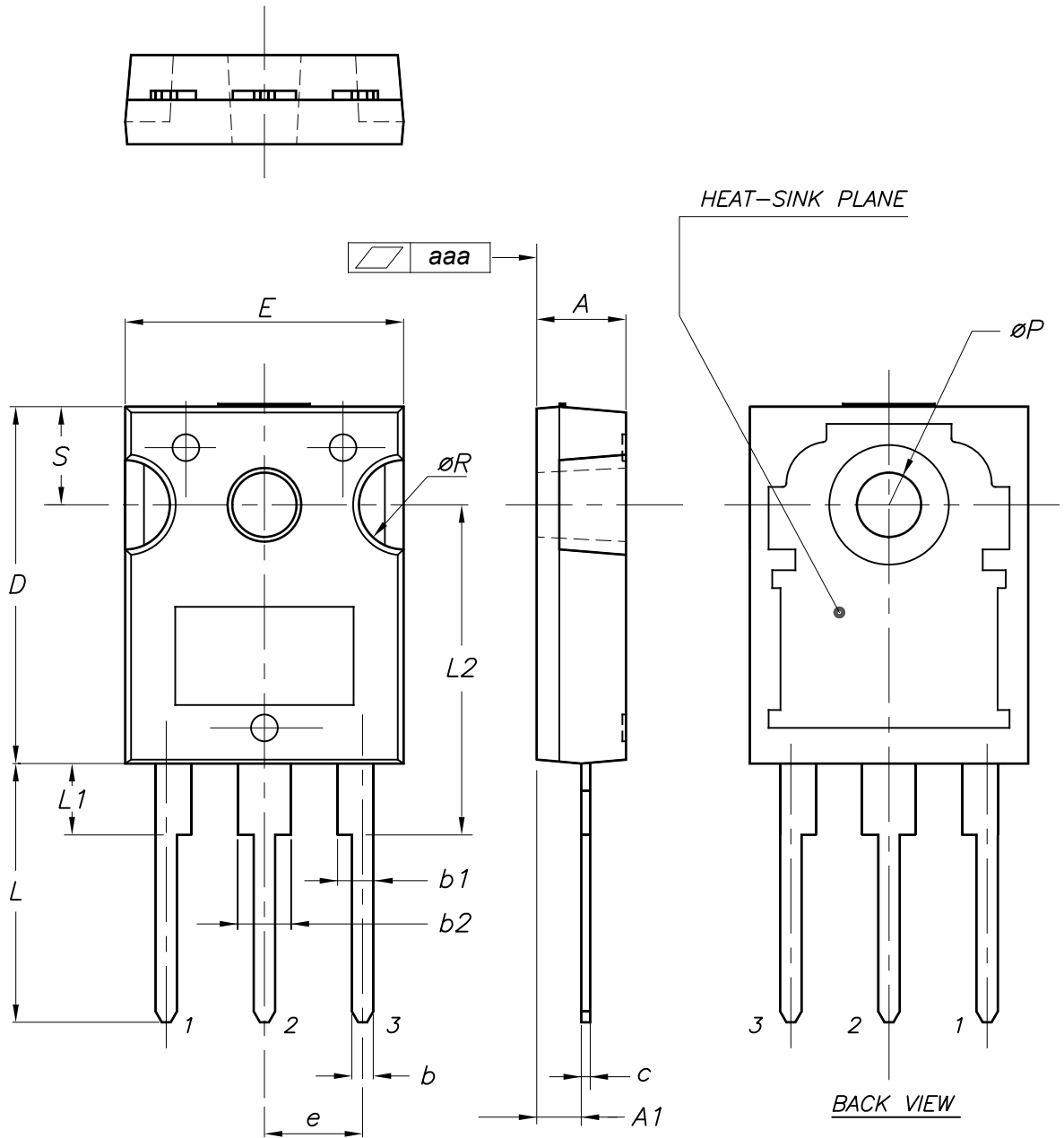

0075325_10

Table 8. TO-247 package mechanical data

| Dim. | mm | | |
|------|-------|-------|-------|
| | Min. | Typ. | Max. |
| A | 4.85 | | 5.15 |
| A1 | 2.20 | | 2.60 |
| b | 1.0 | | 1.40 |
| b1 | 2.0 | | 2.40 |
| b2 | 3.0 | | 3.40 |
| c | 0.40 | | 0.80 |
| D | 19.85 | | 20.15 |
| E | 15.45 | | 15.75 |
| e | 5.30 | 5.45 | 5.60 |
| L | 14.20 | | 14.80 |
| L1 | 3.70 | | 4.30 |
| L2 | | 18.50 | |
| ØP | 3.55 | | 3.65 |
| ØR | 4.50 | | 5.50 |
| S | 5.30 | 5.50 | 5.70 |
| aaa | | 0.04 | 0.10 |

5 Ordering information

Table 9. Order codes

| Order code | Marking | Package | Packing |
|--------------|-----------|---------|---------|
| STGFW40V60DF | G40V60DF | TO-3PF | Tube |
| STGW40V60DF | GW40V60DF | TO-247 | |

Revision history

Table 10. Document revision history

| Date | Revision | Changes |
|-------------|----------|--|
| 20-Mar-2013 | 1 | Initial release |
| 17-Apr-2013 | 2 | Document status promoted from preliminary data to production data. Added: <i>Section 2.1: Electrical characteristics (curves)</i> |
| 04-Jun-2013 | 3 | Added minimum and maximum values for $V_{GE(th)}$ in <i>Table 4: Static characteristics</i> . |
| 11-Sep-2013 | 4 | Updated V_F value in <i>Table 4: Static characteristics</i> . |
| 08-Oct-2013 | 5 | Updated title, features and description in cover page. |
| 10-Jan-2014 | 6 | Updated <i>Figure 8: $V_{CE(sat)}$ vs. junction temperature</i> , <i>Figure 15: Diode V_F vs. forward current</i> and <i>Figure 16: Normalized $V_{GE(th)}$ vs junction temperature</i> . |
| 03-Mar-2014 | 7 | Updated test conditions in <i>Table 7: Diode switching characteristics (inductive load)</i> . |
| 23-Apr-2014 | 8 | Added new device in TO-3PF. Updated <i>Table 1: Device summary</i> , <i>Table 2: Absolute maximum ratings</i> , <i>Table 3: Thermal data</i> and <i>Section 4: Package mechanical data</i> . Added <i>Figure 4: Power dissipation vs. case temperature for TO-3PF</i> , <i>Figure 5: Collector current vs. case temperature for TO-3PF</i> , <i>Figure 11: Collector current vs. switching frequency for TO-3PF</i> and <i>Figure 12: Forward bias safe operating area for TO-247 and TO-3P</i> . Minor text changes. |
| 27-Oct-2017 | 9 | Updated <i>Table 3: "Thermal data"</i> . Added <i>Figure 33: "Thermal impedance for diode in TO-3PF"</i> . Updated <i>Section 4: "Package information"</i> . Minor text changes |
| 06-Mar-2020 | 10 | Updated <i>Section 5 Ordering information</i> . Minor text changes. |
| 17-Feb-2021 | 11 | Modified <i>Figure 3. Power dissipation vs case temperature for TO-3PF</i> , <i>Figure 4. Collector current vs case temperature for TO-3PF</i> , <i>Figure 10. Collector current vs switching frequency for TO-3PF</i> and <i>Figure 12. Forward bias safe operating area for TO-3PF</i> . Minor text changes. |
| 06-Jun-2022 | 12 | The part number STGWT40V60DF has been removed and the document has been updated accordingly. Updated test conditions for the I_{CES} in <i>Table 3. Static characteristics</i> . Updated <i>Section 4.2 TO-247 package information</i> . Minor text changes. |

Contents

| | | |
|------------|---|-----------|
| 1 | Electrical ratings | 2 |
| 2 | Electrical characteristics | 3 |
| 2.1 | Electrical characteristics (curves) | 5 |
| 3 | Test circuits | 11 |
| 4 | Package information | 12 |
| 4.1 | TO-3PF package information | 12 |
| 4.2 | TO-247 package information | 14 |
| 5 | Ordering information | 16 |
| | Revision history | 17 |

IMPORTANT NOTICE – READ CAREFULLY

STMicroelectronics NV and its subsidiaries (“ST”) reserve the right to make changes, corrections, enhancements, modifications, and improvements to ST products and/or to this document at any time without notice. Purchasers should obtain the latest relevant information on ST products before placing orders. ST products are sold pursuant to ST’s terms and conditions of sale in place at the time of order acknowledgment.

Purchasers are solely responsible for the choice, selection, and use of ST products and ST assumes no liability for application assistance or the design of purchasers’ products.

No license, express or implied, to any intellectual property right is granted by ST herein.

Resale of ST products with provisions different from the information set forth herein shall void any warranty granted by ST for such product.

ST and the ST logo are trademarks of ST. For additional information about ST trademarks, refer to www.st.com/trademarks. All other product or service names are the property of their respective owners.

Information in this document supersedes and replaces information previously supplied in any prior versions of this document.

© 2022 STMicroelectronics – All rights reserved