

ADC32RFxx-EVM

The ADC32RFxx-EVM is the circuit board for evaluating the ADC32RFxx family of analog-to-digital converters. This document is intended to guide the ADC32RFxx-EVM user through the process of setting up the EVM successfully. The configuration of the ADC32RF45, ADC32RF44, ADC32RF42, ADC32RF82 and ADC32RF80 in *Digital Down-Convert* (DDC) and *Bypass-DDC* modes with different clocking schemes are covered in this document. The steps for ADC32RF8x also apply to ADC31RF80 (Channel A). ADC31RF80 is a single channel variant.

Contents

1	Overview	2
	1.1 Required Hardware	3
	1.2 Required Software	3
	1.3 Evaluation Board Feature Identification Summary	3
	1.4 References	5
2	Quick Start Guide	6
	2.1 Introduction	6
	2.2 Software Installation	7
	2.3 Hardware Setup Procedure	8
3	Quick-Start Procedure for Bypass LMFS82820 Mode in ADC32RF45	9
	3.1 TSW14J56	9
	3.2 ADC32RFxx EVM	9
	3.3 High Speed Data Converter Pro (HSDC Pro)	11
4	Quick-Start Procedure for Digital DDC (Decimation Plus NCO) Mode in ADC32RF82	13
	4.1 TSW14J56	13
	4.2 ADC32RF82 EVM	13
	4.3 High Speed Data Converter Pro (HSDC Pro)	16
5	Quick-Start Procedure for Digital DDC (Decimation Plus NCO) Mode in ADC32RF4x and ADC32RF8x	19
	5.1 TSW14J56	19
	5.2 ADC32RFxx EVM	19
	5.3 High Speed Data Converter Pro (HSDC Pro)	22
6	Quick-Start Procedure for Bypass LMFS8224 Mode in ADC32RF44 and Internal Clocking	25
	6.1 TSW14J56	25
	6.2 ADC32RF44 EVM	25
	6.3 High Speed Data Converter Pro (HSDC Pro)	26
7	Quick-Start Procedure for Bypass LMFS 42810 Mode in ADC32RF42 With Internal Clocking	27
	7.1 TSW14J56	27
	7.2 ADC32RF42 EVM	27
	7.3 High Speed Data Converter Pro (HSDC Pro)	29
8	ADC32RFxx Internally Generated Clocking	31
	8.1 ADC32RF45 EVM LMX2582 (or LMX2592) Clocking	31
	8.2 ADC32RF45 EVM LMK04828 Clocking	32

List of Figures

1	EVM Feature Locations	4
2	ADC32RFxx-EVM GUI Bench Setup Block Diagram	8
3	ADC32RFxx-EVM GUI LMK04828 PLL1 Page Bypass Mode	9
4	ADC32RFxx-EVM Quick Setup View Bypass Mode	10

5	ADC32RFxx-EVM GUI JESD204B Tab Bypass Mode.....	11
6	HSDC Pro Device Selection LMFS_82820 Mode.....	11
7	Example Capture from Channel A – Bypass Mode.....	12
8	ADC32RFxx-EVM GUI LMK04828 PLL1 Page DDC Mode	13
9	ADC32RFxx-EVM Quick Setup View DDC Mode.....	14
10	ADC32RFxx-EVM GUI JESD204B Configuration Tab DDC Mode	14
11	ADC32RFxx-EVM GUI DDC Configuration Tab	15
12	Connecting to TSW14J56.....	16
13	HSDC Pro Device Selection LMFS8821 Mode.....	16
14	Download Firmware.....	16
15	Resetting the TSW14J56.....	17
16	Popup Window for Setting HSDC Pro Decimation Factor and NCO Frequency	17
17	Example Capture From Channel A – 8x Decimation Mode	18
18	ADC32RFxx-EVM GUI LMK04828 PLL1 Page DDC Mode	20
19	ADC32RFxx-EVM Quick Setup View DDC Mode.....	20
20	ADC32RFxx-EVM GUI JESD204B Configuration Tab DDC Mode	21
21	ADC32RFxx-EVM GUI DDC Configuration Tab	21
22	Connecting to TSW14J56.....	22
23	HSDC Pro Device Selection LMFS8821 Mode.....	22
24	Download Firmware.....	22
25	Resetting the TSW14J56.....	23
26	Popup Window for Setting HSDC Pro Decimation Factor and NCO Frequency	23
27	Example Capture From Channel A – 8x Decimation Mode	24
28	ADC32RF44-EVM Quick Setup View Bypass Mode	25
29	HSDC Pro Device Selection LMFS_8224 Mode	26
30	Example Capture from Channel A – LMFS8224 Mode	26
31	ADC32RF42-EVM Quick Setup View Bypass Mode	28
32	HSDC Pro Device Selection LMFS_42810 Mode.....	29
33	Example Capture from Channel A – LMFS42810 Mode.....	30
34	ADC32RFxx EVM GUI With LMX Clock Configuration	31
35	ADC32RFxx EVM GUI With LMK Clock Configuration.....	32

Trademarks

Microsoft, Windows are registered trademarks of Microsoft Corporation.
LabVIEW is a trademark of National Instruments.

1 Overview

The ADC32RFxx-EVM is an evaluation module (EVM) designed to evaluate the ADC32RFxx family of high-speed, JESD204B interface ADCs. The EVM includes an onboard clocking solution (LMK04828), transformer-coupled analog inputs, full power solution, and easy-to-use software GUI and USB interface. The following features apply to this EVM:

- Transformer-coupled signal input network allowing a single-ended signal source from 30 MHz to 3000 MHz.
- LMK04828 system clock generator that generates field-programmable gate array (FPGA) reference clocks for the high-speed serial interface and may optionally be used to generate the ADC sampling clock.
- Transformer-coupled clock input network to test the ADC performance with a very low-noise clock source.
- LMX2582 (or LMX2592) clock synthesizer to generate a very low-noise clock source for clocking the ADC32RFxx ADC.
- High-speed serial data output over a standard FPGA Mezzanine Card (FMC) interface connector.

The ADC32RFxx-EVM is designed to work seamlessly with TI's TSW14J56 EVM JESD204B data capture/pattern generator card, through the High Speed Data Converter Pro (HSDC Pro) software tool for high-speed data converter evaluation. It is also designed to work with many of the development kits from leading FPGA vendors that contain an FMC connector.

1.1 Required Hardware

The following equipment is **included** in the EVM evaluation kit:

- ADC32RFxx evaluation board (EVM)
- Power supply cable
- Mini-USB cable

The following list of equipment are items that are **not included** in the EVM evaluation kit but are items required for evaluation of this product in order to achieve the best performance:

- TSW14J56EVM data capture board, two 5-V power supplies, and mini-USB cable
- Computer running Microsoft® Windows® XP, or newer
- One low-noise signal generator. **Recommendations:**
 - RF generator, > +17 dBm, < -40 dBc harmonics, < 500 fs jitter 20 kHz–20 MHz, 10-MHz to 3-GHz frequency range
Examples: HP HP8644B, Rohde & Schwarz SMA100A
- Bandpass filter for desired analog input. **Recommendations:**
 - Bandpass filter, ≥ 60-dB harmonic attenuation, ≤ 5% bandwidth, > +18-dBm power, < 5-dB insertion loss
Examples: Trilithic 5VH-series Tunable BPF, K&L BT-series Tunable BPF, TTE KC6 or KC7-series Fixed BPF
- Signal path cables, SMA or BNC with BNC-to-SMA adapters

1.2 Required Software

The following software is required to operate the ADC32RF45 EVM and is available online. See the [References](#) section for links.

- ADC32RFxx EVM SPI GUI

The following software is required to operate the TSW14J56EVM and is available online. See the [References](#) section for links.

- High Speed Data Converter Pro software, version 4.2 or higher

1.3 Evaluation Board Feature Identification Summary

The EVM features are labeled in [Figure 1](#).

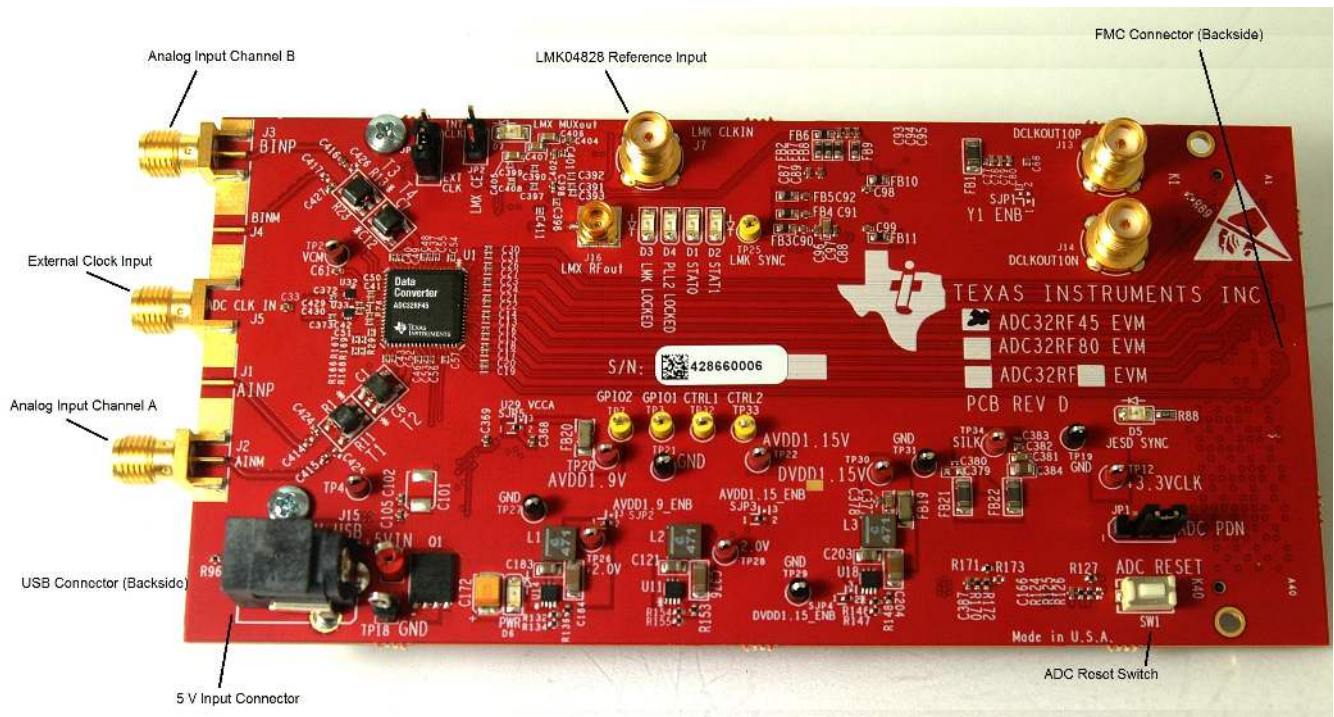

Figure 1. EVM Feature Locations

1.4 References

Use the following links to available documentation and software:

- ADC32RFxx EVM software, available from: www.ti.com/tool/ADC32RFxxEVM
- ADC32RF45 data sheet ([SBAS747](#))
- ADC32RF45 product page www.ti.com/product/ADC32RF45
- ADC32RF44 data sheet ([SBAS809](#))
- ADC32RF44 product page www.ti.com/product/ADC32RF44
- ADC32RF8x data sheet ([SBAS774](#))
- ADC32RF80 product page www.ti.com/product/ADC32RF80
- LMK04828 data sheet ([SNAS605](#))
- TSW14J56EVM User's Guide ([SLWU086](#))
- High Speed Data Converter Pro software ([SLWC107](#)) and User's Guide ([SLWU087](#)), available at www.ti.com/tool/dataconverterpro-sw
- HSDC Pro GUI Updates ([SLWC106](#)), available at www.ti.com/tool/dataconverterpro-sw

NOTE: The EVM schematics, layout, and BOM are available on the [ADC32RF45EVM](#) tool page on www.ti.com.

2 Quick Start Guide

The EVM test procedure to obtain a valid data capture from the ADC32RFxx-EVM using the TSW14J56EVM capture card is provided in this section. This is the starting point for all evaluations.

2.1 Introduction

The ADC32RFxx-EVM includes the ADC32RF4x or ADC32RF8x analog-to-digital converter with JESD204B interface, and the LMK04828 clock chip to generate the device clock and SYSREF to the ADC. Also included on the EVM is the optional LMX2582 or LMX2592 clock synthesizer device. Jumpers and solder options on the EVM allow selection of the ADC sample clock from the LMX2582, the LMK04828, or from a transformer-coupled external SMA input. The default assembly option is the transformer-coupled external clocking option as set by jumper JP3. The EVM has an FMC connector suitable for connection to readily-available FPGA development boards or to the TSW14J56 capture card.

The FPGA on the capture card also requires a device clock and SYSREF signal and the LMK04828 clock device also supplies these signals to the FMC connector for that purpose.

This document conveys all information needed to bring up the ADC32RFxx-EVM and TSW14J56 capture card, and get a valid data capture with good FFT results.

The JESD204B interface requires a number of important parameters to be decided in advance of setting up the data link, such as; number of lanes, number of converters, number of samples per frame, and a value K number of frames per multi-frame, among other parameters. Both sides of a JESD204B link must be set up with the same values for all these parameters, or else the FPGA that receives the data will not be able to establish a synchronized link. **Getting these parameters inconsistent between ADC and FPGA is perhaps the biggest single reason for an EVM setup to not function as expected.** The GUI installers that come with the ADC32RF4xx and the TSW14J56 come with configuration files that are meant to enable quick initial setup of a number of basic configurations. TI **strongly** suggests setting up the EVM and capture card with a configuration described in this document and getting a working setup before modifying the configuration to be closer to what the end-application requires. In this way the user can know that the hardware is functioning, and that there is a working configuration that they can go back to in the event of difficulty developing their own configuration.

The HSDC Pro GUI that comes with the TSW14J56 requires initialization files for both the decimation and mixer logic (DDC) and the non-decimated full-rate mode called LMF82820 or 5-sample mode. (LMF82820 mode means that there are 8 lanes in use for 2 channels of ADC, with 8 octets of information on each lane per frame, for 20 samples of data per frame per channel. That is equivalent to 5 samples per lane per frame, hence the mode being called 5 sample mode. 5 samples per lane times 8 lanes is 40 samples, or 20 samples per channel. This mode is sometimes called bypass mode because the decimation and mixer logic is bypassed in favor of full rate output).

Please note that the configuration files for setting up the LMK04828 clocking device are different for the DDC case than they are for the non-decimation (5-sample) case. The different modes of operation of the ADC affect the data rates on the JESD204B interface, and thus affect the clocking needed for the FPGA. The configuration files are **not** interchangeable. For example, the LMK_ADC32RF45_bypass_2457 Msps.cfg file and LMK_ADC32RF45_2457 Msps.cfg file both set the sample clock for the ADC at 2.4576 GHz, but the SYSREF and the device clock to the FPGA is different for the two files.

This document introduces the software that must be installed on a PC, and presents a basic setup for the Bypass and DDC modes available in the ADC32RF45, both modes being clocked by an externally supplied clock. The LMK04828 clock chip supplies SYSREF to the ADC and clock and SYSREF to the TSW14J56. ADC32RF8x can be configured in DDC mode by following the same steps as that for ADC32RF45. ADC32RF44 only supports a maximum clock rate of 2.6 Gbps and an example configuration with internally generated clock (on-board LMX2582) is shown. The last section covers the steps to supply an internally-generated sample clock to the ADC, by either the LMK04828 or LMX2582.

2.2 Software Installation

The proper software must be installed before beginning evaluation. See [Section 1.2](#) for a list of the required software. The [References](#) section of this document contains links to find the software on the TI website.

Important: The software must be installed before connecting the ADC32RFxx-EVM and TSW14J56 to the computer for the first time.

The ADC32RFxx-EVM is controlled through an easy-to-use graphical user interface (GUI) to provide access to the ADC (ADC32RF4x or ADC32RF8x), clock chip (LMK04828), and clock synthesizer (LMX2582 or LMX2592) SPI interfaces. There is a tab in the GUI for each of the devices. This GUI requires the LabVIEW™ runtime engine, which is automatically installed during the loading of the software.

2.2.1 ADC32RFxx EVM GUI Installation

1. Copy the provided installer software called *ADC32RFxx EVM GUI Installer.zip* (or newer revision on the TI web, if available) under the [ADC32RFxx Customer Files\Software](#) folder to a local host PC.
2. Unzip the installer.
3. Go to *ADC32RF4xx EVM SPI GUI Installer\Volume* and double click on *setup.exe*.
4. Follow the installer instructions. After the installer is completed, the executable is located at
C:\Program Files (86)\Texas Instruments\ADC32RFxx EVM GUI
5. Start the GUI by double clicking on **ADC32RFxx EVM GUI.exe** or *Start Menu → All Programs → Texas Instruments → ADC32RFxxGUI*.
6. When plugging the board into the computer for the first time through the USB cable, you may be prompted to install the USB drivers.
 - Windows XP: If Windows XP does not automatically install the drivers, follow the prompts on the screen to do so. Do not let Windows XP search Microsoft Update for the drivers, but do let Windows XP install the drivers automatically.
 - Windows 7: After installing the GUI, Windows 7 should automatically be able to install the drivers for the ADC32RFxx-EVM with no input from the user.

2.2.2 High Speed Data Converter Pro GUI Installation

High Speed Data Converter Pro (HSDC Pro) is used to control the TSW14J56EVM and analyze the captured data. Please see the *HSDC Pro GUI* user's guide ([SLWU087](#)) for more information.

1. Download HSDC Pro from the TI website. The [References](#) section of this document contains the link to find the software on the TI website.
2. Extract the files from the zip file.
3. Run *setup.exe* and follow the installation prompts.
4. If the version of HSDC Pro is 4.5 or lower, download HSDC Pro GUI updates from the TI website. The [References](#) section of this document contains the link to find the software on the TI website.
5. Extract the files from the zip file, run *HSDC Pro Patch vx.xx.exe* and follow the installation instructions.

2.3 Hardware Setup Procedure

A typical test setup using the ADC32RFxx-EVM and TSW14J56EVM is shown in Figure 2. This is the test setup used for the quick-start procedure.

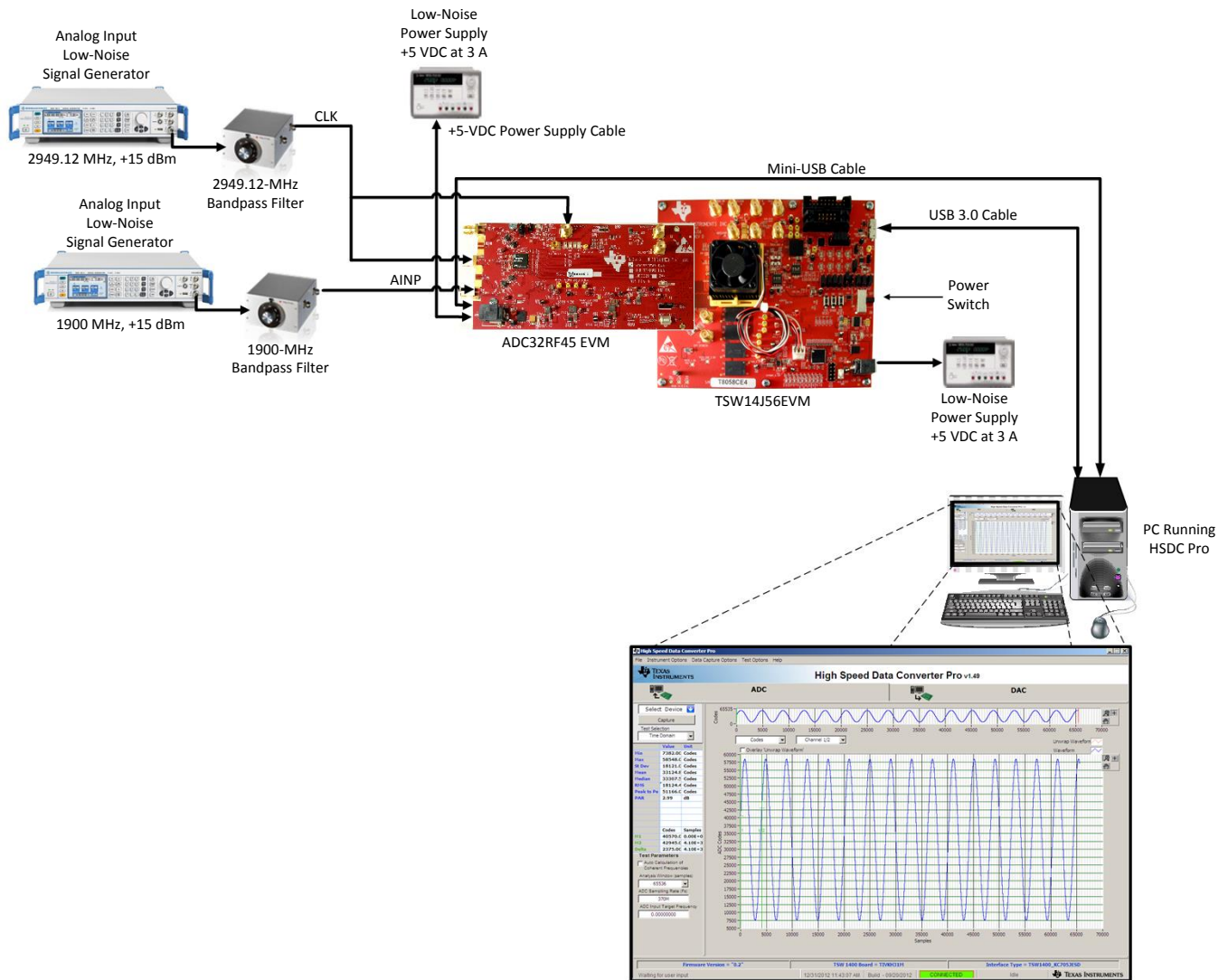

Figure 2. ADC32RFxx-EVM GUI Bench Setup Block Diagram

3 Quick-Start Procedure for Bypass LMFS82820 Mode in ADC32RF45

This mode is available only in the ADC32RF4x family and is not available in ADC32RF8x family of devices. Please check the package marking on the ADC to confirm compatibility of the device mounted on the EVM with this mode.

3.1 TSW14J56

1. Connect the ADC32RFxx EVM to the TSW14J56 using the FMC connectors.
2. Connect a 5-V power supply to connector J11 (+5V IN).
3. Connect a USB cable to the USB connector (J9).
4. Flip the power switch (SW6) to the “ON” position.

3.2 ADC32RFxx EVM

1. Verify the clocking selection jumper JP3 is set to EXT for external clocking.
2. Connect a 5-V, 3-A power supply to connector J15. Do not use a supply that is rated less than 3 A.
3. Connect a USB cable to the USB connector (J11 bottom side of board).
4. Connect an analog RF signal from the signal source to the AINP SMA (J2).
5. Connect a signal generator set for 2.94912 GHz to the external clock input J5.
6. Connect another signal generator set for 2.94912 GHz to the LMK04828 reference clock input J7. (Make sure the two signal generators for the ADC clock and LMK04828 clock are synchronized to the same time base, or use a single signal generator and a splitter to generate two copies of the clock to go to the EVM.)

F_s = 2.94912 GHz, 5-Sample Example

This example captures data from channel A of the ADC32RFxx EVM sampling at 2.94912 GHz with a 1900-MHz input source. The ADC requires the device clock and SYSREF signals to be present **before** the ADC can be properly configured. The steps to configure into this mode follow:

1. Open the ADC32RFxx EVM GUI.
2. Verify that the green *USB Status* indicator is lit. If it is not lit, click the **Reconnect?** button and check the *USB Status* indicator again. If it is still not lit then verify the EVM is connected to the computer through USB. Whenever the USB link is disturbed, the GUI must obtain a new handle to address the proper USB port, and the **Reconnect?** button does that.
3. On the PLL1 tab of the LMK04828 tab, press the **RESET** button.

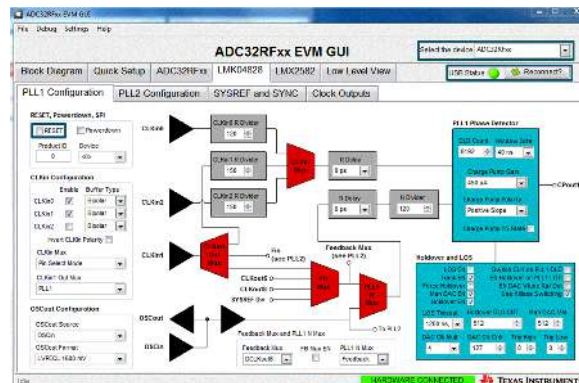

Figure 3. ADC32RFxx-EVM GUI LMK04828 PLL1 Page Bypass Mode

4. On the ADC32RFxx-EVM, press SW1 (*ADC RESET*) to provide a hardware reset to the ADC.
5. Click on the *Quick Setup* tab.
6. Select the *Nyquist Zone* for the input. It is the 2nd Nyquist in this example setup ($F_s = 2949.12\text{M}$, $F_{in} = 1900\text{M}$).

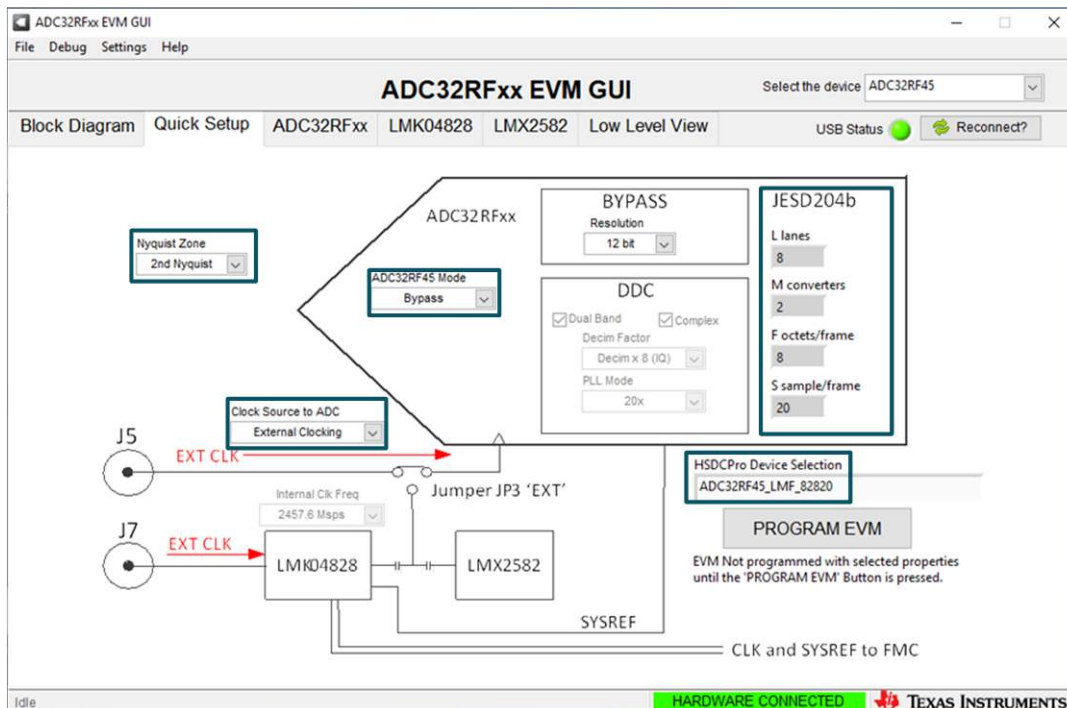

Figure 4. ADC32RFxx-EVM Quick Setup View Bypass Mode

7. Select the *Clock Source to ADC*. In this example, *External Clcking* is selected.
8. Select *ADC32RF45 Mode*. In this example, *Bypass* is chosen.
9. Select *Resolution*. In this example, *12 bit* is selected.
10. Press **PROGRAM EVM**.
11. After pressing the **PROGRAM EVM** button, the device is configured as shown in [Figure 4](#) and [Figure 5](#) indicating the 12 bit packed 5 sample mode for LMFS82820.

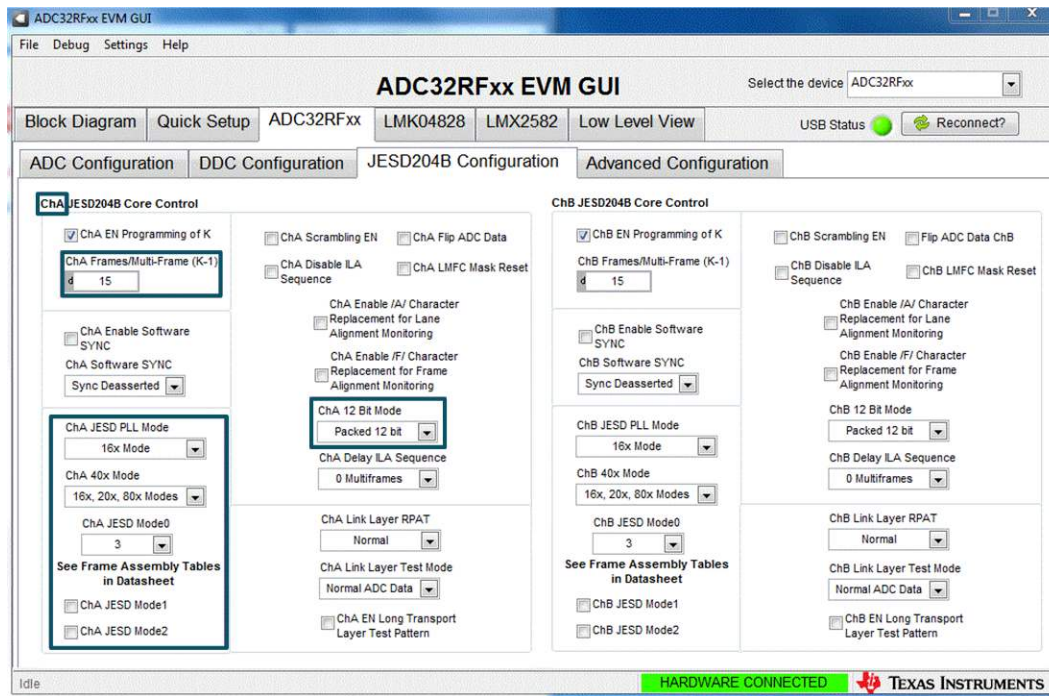

Figure 5. ADC32RFxx-EVM GUI JESD204B Tab Bypass Mode

3.3 High Speed Data Converter Pro (HSDC Pro)

1. Open High Speed Data Converter Pro (v4.5 or newer) by going to *Start Menu* → *All Programs* → *Texas Instruments* → *High Speed Data Converter Pro*.
2. Click *OK* to connect to the TSW14J56. If there is more than one TSW14J56 connected to the host PC, select the appropriate serial number of the board to be programmed.
3. Select the *ADC* tab at the top of the GUI.
4. Use the *Select ADC* drop-down menu at the top left corner to select *ADC32RF45_LMF_82820*.

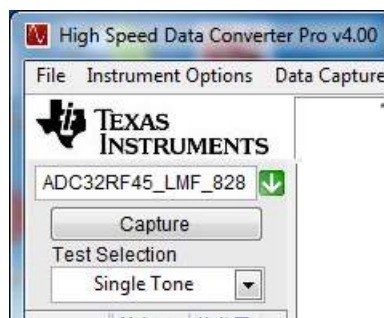

Figure 6. HSDC Pro Device Selection LMFS_82820 Mode

5. When prompted to update the firmware for the ADC, click **Yes** and wait for the firmware to download to the TSW14J56.
6. After the firmware download has completed, enter “2949.12M” into the *ADC Output Data Rate* field at the bottom left corner of the HSDC Pro GUI.
7. Select “Channel 1/2” in the channel select window located at the top middle of the GUI.
8. Click the *Instrument Options* menu at the top of HSDC Pro and select *Reset Board*.
9. Click the **Capture** button in HSDC Pro to capture data from the ADC.
10. The result should match the example capture in [Figure 7](#).

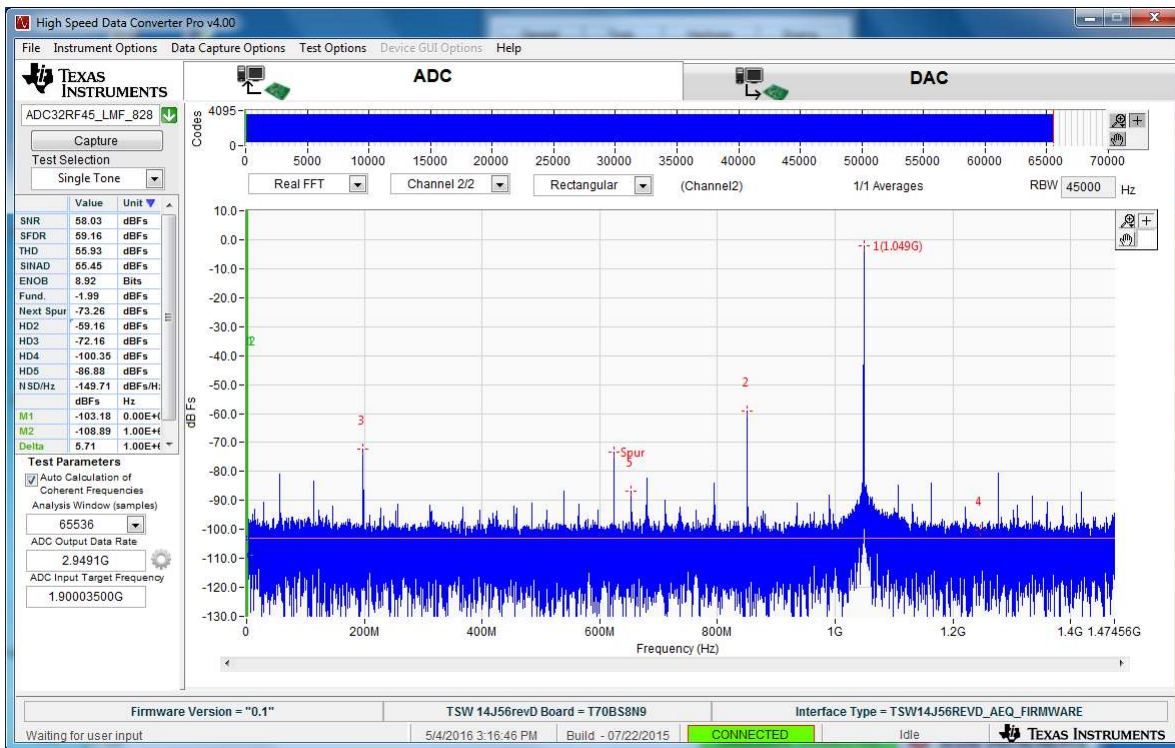

Figure 7. Example Capture from Channel A – Bypass Mode

4 Quick-Start Procedure for Digital DDC (Decimation Plus NCO) Mode in ADC32RF82

The clock rate in this example is 2 Gsps.

4.1 TSW14J56

1. Connect the ADC32RF82 EVM to the TSW14J56 using the FMC connectors.
2. Connect a 5-V power supply to connector J11 (+5 V IN).
3. Connect a USB cable to the USB connector (J9).
4. Flip the power switch (SW6) to the "ON" position.

4.2 ADC32RF82 EVM

1. Verify jumper JP3 is set for position EXT to select external clocking.
2. Connect a 5-V, 3-A power supply to connector J15. Do not use a supply that is rated less than 3 A.
3. Connect a USB cable to the USB connector (J11 on the bottom side of board).
4. Connect an analog RF signal from a signal source to the AINP SMA (J2).
5. Connect a signal generator set at 2 GHz to the external clock input J5.
6. Connect another signal generator set for 2 GHz to the LMK04828 reference clock input J7. (Make sure the two signal generators for the ADC clock and LMK04828 clock are synchronized to the same time base, or use a single signal generator and a splitter to generate two copies of the clock to go to the EVM.)

F_s = 2 GHz, 8x Decimation Example, External Clocking

This example captures 8x decimated data from channel A of the ADC32RF82 EVM sampling at 2 GHz with a 1860-MHz RF input source. **The ADC requires the device clock and SYSREF signals to be present before the ADC can be properly configured so the LMK (and optional LMX, if used) setup must have been done before configuring the ADC.**

1. Open the ADC32RFxx EVM GUI.
2. Verify that the green *USB Status* indicator is lit. If it is not lit, click the **Reconnect?** button and check the *USB Status* indicator again. If it is still not lit then verify the EVM is connected to the computer through USB. Whenever the USB link is disturbed, the GUI must obtain a new handle to address the proper USB port, and the **Reconnect?** button does that.

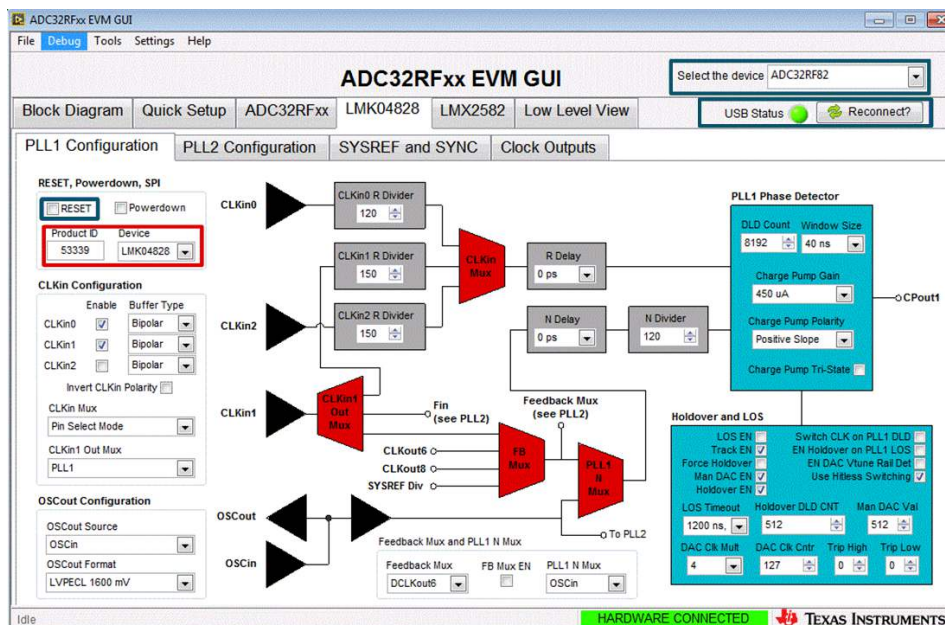

Figure 8. ADC32RFxx-EVM GUI LMK04828 PLL1 Page DDC Mode

3. On the *LMK04828 PLL1* tab, press the **RESET** button.
4. On the ADC32RFxx-EVM, press SW1 (*ADC RESET*) to provide a hardware reset to the ADC.
5. Click on the *Quick Setup* tab.
6. Select the *Nyquist Zone* for the input. It is the 2nd Nyquist in this example setup ($F_s=2000M$, $F_{in}=1860M$).

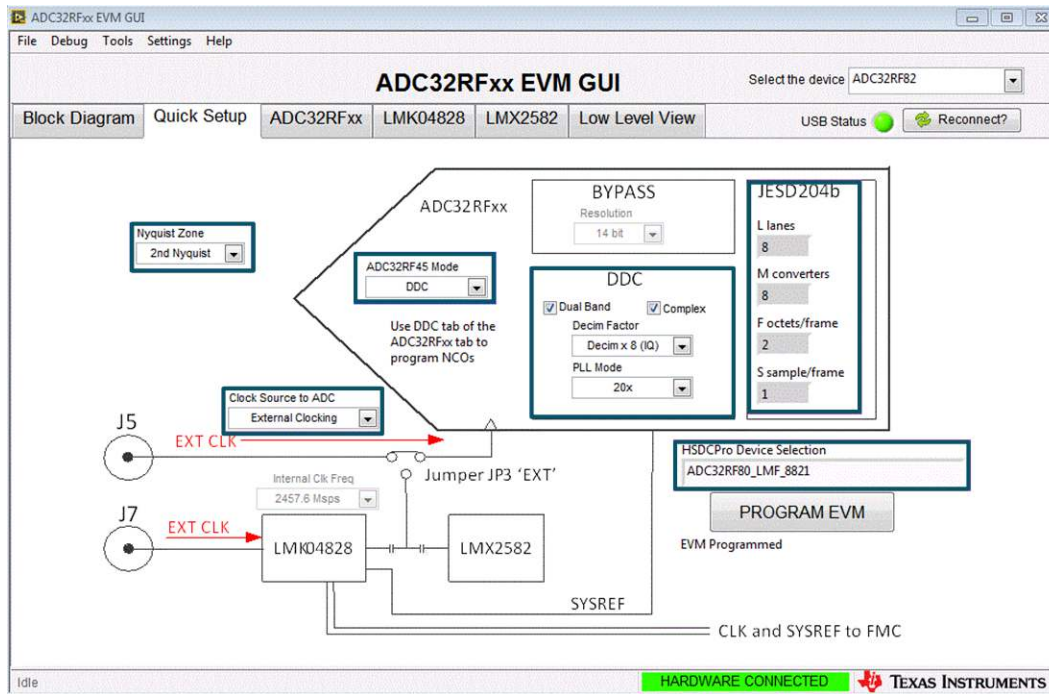

Figure 9. ADC32RFxx-EVM Quick Setup View DDC Mode

7. Select the *Clock Source to ADC*. In this example, *External Clcking* is selected.
8. Select *ADC32RF45 Mode*. In this example, *DDC* is chosen.
9. Press the **PROGRAM EVM** button.
10. After pressing the **PROGRAM EVM** button, the device is configured as shown in Figure 9 and Figure 10.

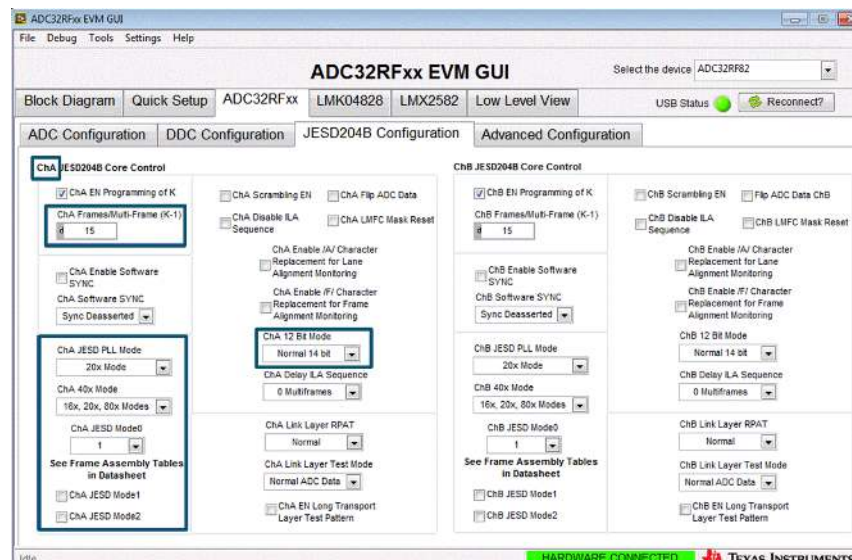

Figure 10. ADC32RFxx-EVM GUI JESD204B Configuration Tab DDC Mode

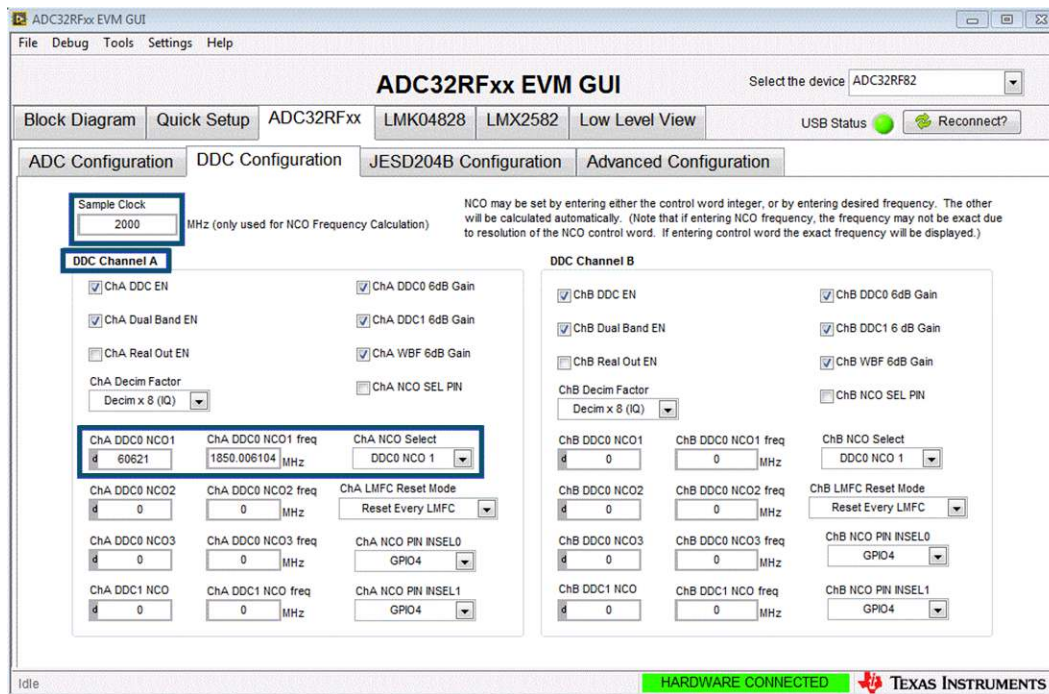

Figure 11. ADC32RFxx-EVM GUI DDC Configuration Tab

11. Enter "2000" in the box for *Sample Clock* rate in MHz.
12. Enter "1850" in the box for the *Channel A DDC0 NCO1* frequency. The control value for NCO1 should become 60621 as shown in [Figure 11](#)

NOTE: These settings only apply with $F_s = 2000$ MHz. The NCOs in the ADC32RFxx are set to a desired LO frequency by a numeric control that is a fraction of the sampling frequency. If the sampling frequency changes, then the NCO frequency changes. In order to *find* the input tone in the resulting FFT capture, the sampling frequency and the NCO frequency must be known in order to know where the input tone should be located in the final FFT result.

4.3 High Speed Data Converter Pro (HSDC Pro)

1. Open High Speed Data Converter Pro by going to *Start Menu* → *All Programs* → *Texas Instruments* → *High Speed Data Converter Pro*.
2. Click *OK* to connect to the TSW14J56. If there is more than one TSW14J56 connected to the host PC, select the appropriate serial number of the board to be programmed.

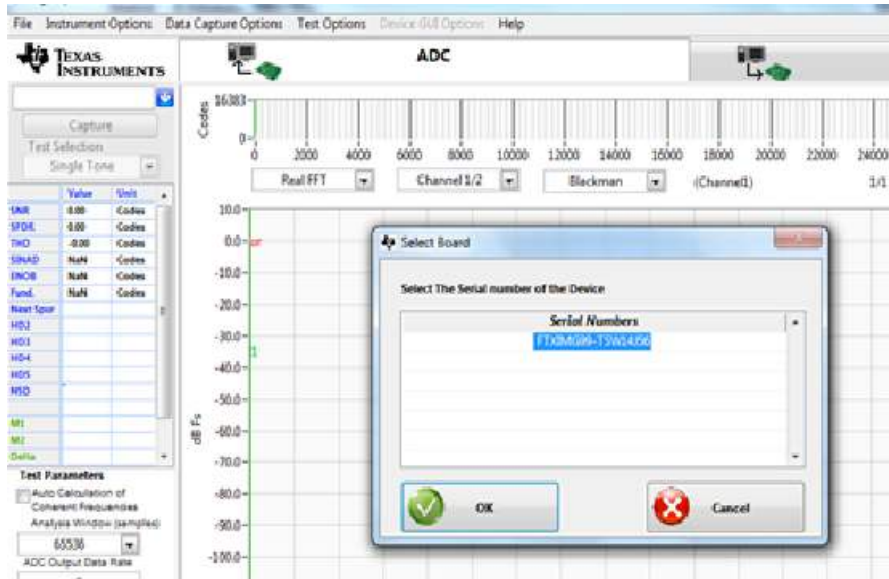

Figure 12. Connecting to TSW14J56

3. Select the *ADC* tab at the top of the GUI.
4. Use the *Select ADC* drop-down menu at the top left corner to select *ADC32RF80_LMF_8821* as Figure 13 shows.

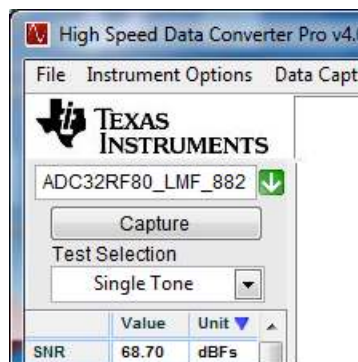

Figure 13. HSDC Pro Device Selection LMFS8821 Mode

5. When prompted to update the firmware for the ADC, click *Yes* and wait for the firmware to download to the TSW14J56. The following message appears while the firmware is downloading to the FPGA. (Downloading firmware does not mean the GUI is looking for newer revisions at ti.com. It simply means the bit file for the firmware for the FPGA is being pushed to the FPGA through the USB cable.)

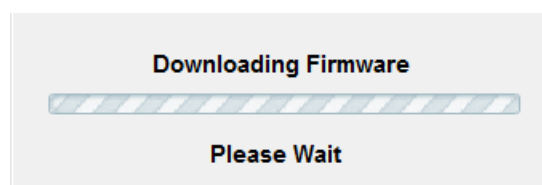

Figure 14. Download Firmware

6. After the firmware download has completed, enter “250M” into the *ADC Output Data Rate* field at the bottom left corner of the HSDC Pro GUI (2 GHz sample rate divided by 8). A common mistake is to type 'm' instead of 'M' in which case the frequency entered is in milli-Hz instead of mega-Hz. Another common mistake is to omit the 'M' in which case the frequency entered is in Hz.
7. Select “Channel 1/8” in the channel select window located at the top middle of the GUI.
8. Click the *Instrument Options* menu at the top of HSDC Pro and select *Reset Board*.

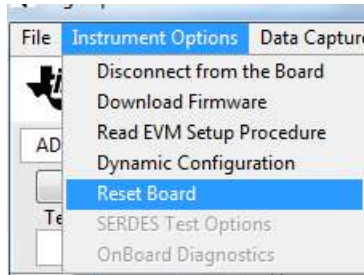

Figure 15. Resetting the TSW14J56

9. Click *Capture* in HSDC Pro to capture data from the ADC.
10. Select *Complex FFT*
11. The result should match the example capture in [Figure 17](#).

The input tone is seen to be near 10 MHz because the signal generator is set to 1.86 GHz while the NCO in the ADC is set to 1.85 GHz. So, the input tone is mixed down to 10 MHz. If the signal generators for the analog input tone and the clocking are synchronized, then HSDC Pro is able to locate the expected tone after the NCO and decimation by way of the popup parameter window of [Figure 16](#). If this popup is used, the frequency values entered must be exact.

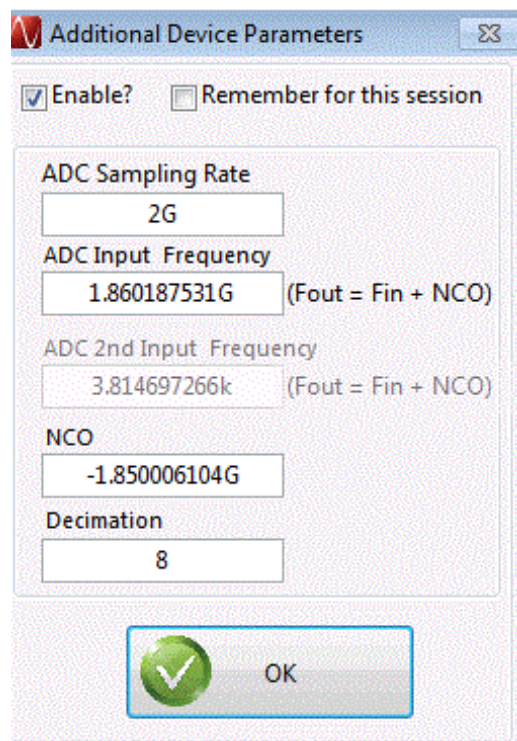

Figure 16. Popup Window for Setting HSDC Pro Decimation Factor and NCO Frequency

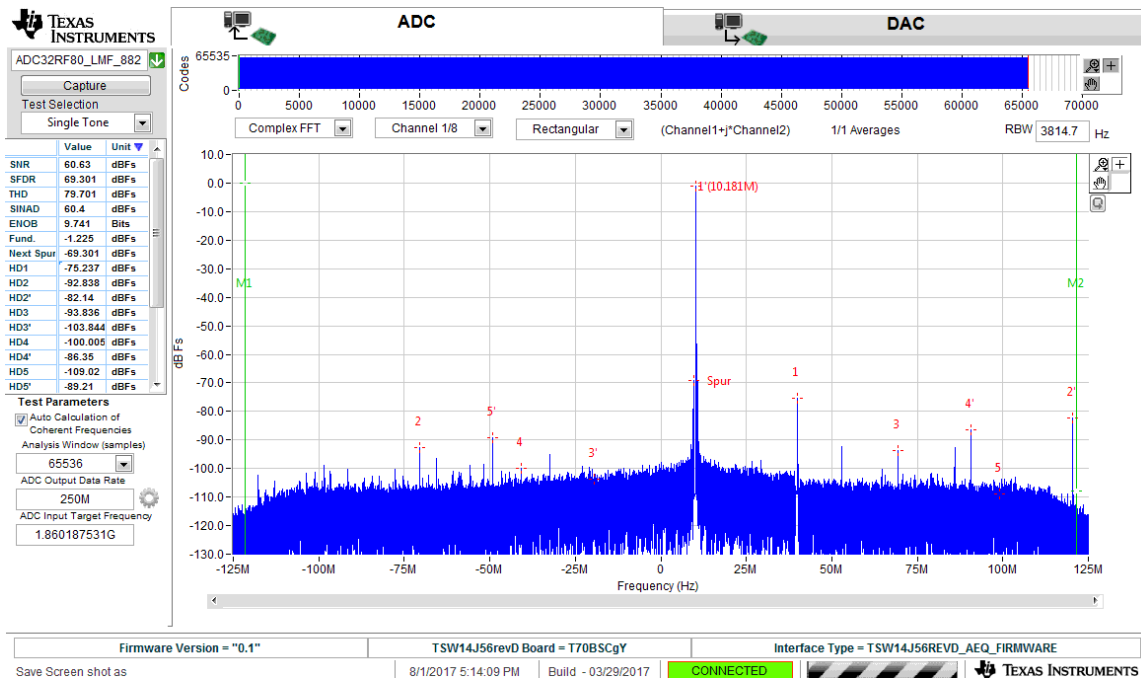

Figure 17. Example Capture From Channel A – 8x Decimation Mode

5 Quick-Start Procedure for Digital DDC (Decimation Plus NCO) Mode in ADC32RF4x and ADC32RF8x

The clock rate in this example is 2.94912 Gsps and is only supported by the ADC32RF45 and ADC32RF80. For the ADC32RF44, the same steps can be followed, albeit at a lower clock rate (≤ 2.6 Gsps).

5.1 TSW14J56

Follow these steps to use the TSW14J56 with the ADC32RFxx EVM:

1. Connect the ADC32RFxx EVM to the TSW14J56 using the FMC connectors.
2. Connect a 5-V power supply to connector J11 (+5 V IN).
3. Connect a USB cable to the USB connector (J9).
4. Flip the power switch (SW6) to the “ON” position.

5.2 ADC32RFxx EVM

Use the following steps to prepare the ADC32RFxx EVM for use:

1. Verify jumper JP3 is set for position EXT to select external clocking.
2. Connect a 5-V, 3-A power supply to connector J15. Do not use a supply that is rated less than 3 A.
3. Connect a USB cable to the USB connector (J11 on the bottom side of board).
4. Connect an analog RF signal from a signal source to the AINP SMA (J2).
5. Connect a signal generator set for 2.94912 GHz to the external clock input J5.
6. Connect another signal generator set for 2.94912 GHz to the LMK04828 reference clock input J7. (Make sure the two signal generators for the ADC clock and LMK04828 clock are synchronized to the same time base, or use a single signal generator and a splitter to generate two copies of the clock to go to the EVM.)

F_s = 2.94912 GHz, 8x Decimation Example, External Clocking

This example captures 8× decimated data from channel A of the ADC32RFxx EVM sampling at 2.94912 GHz with a 1960-MHz IF input source. **The ADC requires the device clock and SYSREF signals to be present before the ADC can be properly configured so the LMK (and optional LMX, if used) setup must be done before configuring the ADC.**

1. Open the ADC32RFxx EVM GUI.
2. Verify that the green *USB Status* indicator is lit. If it is not lit, click the **Reconnect?** button and check the *USB Status* indicator again. If it is still not lit then verify the EVM is connected to the computer through USB. Whenever the USB link is disturbed, the GUI must obtain a new handle to address the proper USB port, and the **Reconnect?** button does that.

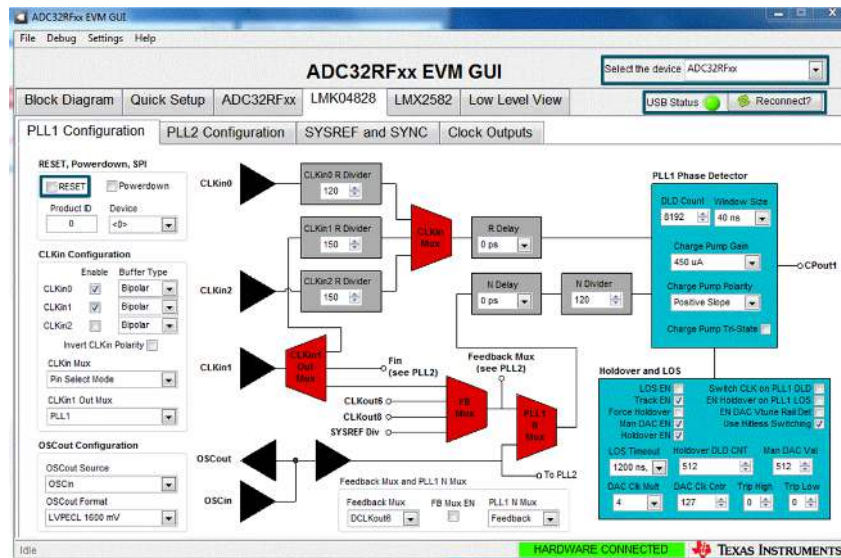

Figure 18. ADC32RFxx-EVM GUI LMK04828 PLL1 Page DDC Mode

3. On the *LMK04828 PLL1* tab, press the **RESET** button.
4. On the ADC32RFxx-EVM, press SW1 (*ADC RESET*) to provide a hardware reset to the ADC.
5. Click on the *Quick Setup* tab.
6. Select the *Nyquist Zone* for the input. It is the 2nd Nyquist in this example setup ($F_s=2949.12M$, $F_{in}=1960M$).

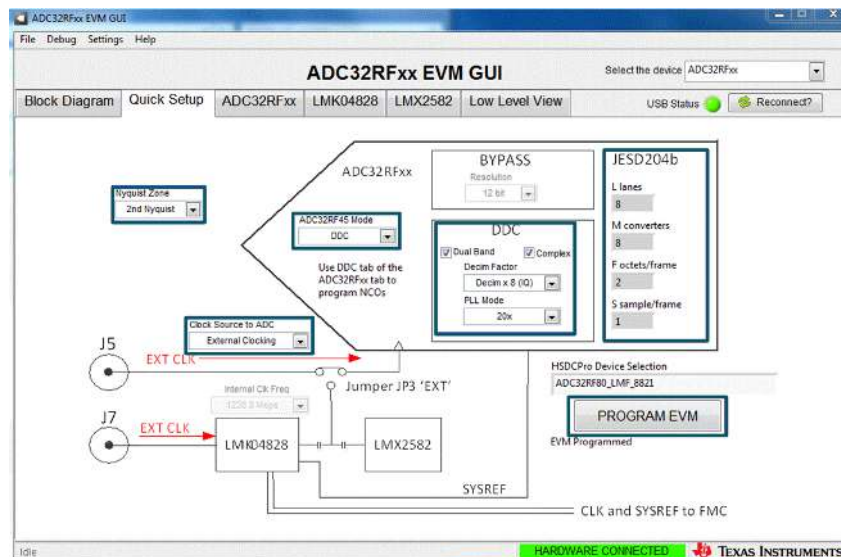

Figure 19. ADC32RFxx-EVM Quick Setup View DDC Mode

7. Select the *Clock Source to ADC*. In this example, *External Clocking* is selected.
8. Select *ADC32RF45 Mode*. In this example, *DDC* is chosen.
9. Press the **PROGRAM EVM** button.

- After pressing the **PROGRAM EVM** button, the device is configured as shown in [Figure 19](#) and [Figure 20](#), indicating the 12-bit packed, 5-sample mode for LMFS82820.



Figure 20. ADC32RFxx-EVM GUI JESD204B Configuration Tab DDC Mode

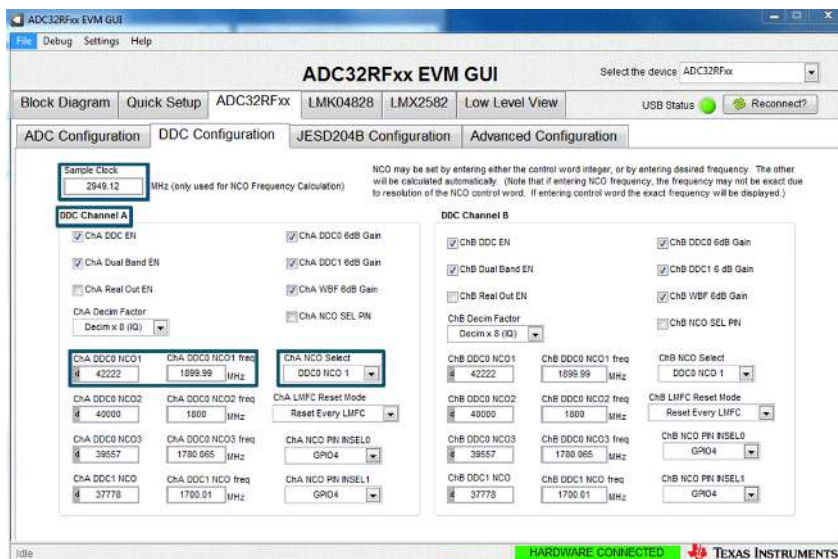

Figure 21. ADC32RFxx-EVM GUI DDC Configuration Tab

- Enter "2949.12" in the box for *Sample Clock* rate in MHz.
- Enter "1900" in the box for the *Channel A DDC0 NCO1* frequency. The control value for NCO1 should become 42222 as shown in [Figure 21](#)

NOTE: These settings only apply with $F_s = 2.94912$ GHz. The NCOs in the ADC32RF80 are set to a desired LO frequency by a numeric control that is a fraction of the sampling frequency. If the sampling frequency changes, then the NCO frequency changes. In order to *find* the input tone in the resulting FFT capture, the sampling frequency and the NCO frequency must be known in order to know where the input tone should be located in the final FFT result.

5.3 High Speed Data Converter Pro (HSDC Pro)

1. Open High Speed Data Converter Pro by going to *Start Menu* → *All Programs* → *Texas Instruments* → *High Speed Data Converter Pro*.
2. Click *OK* to connect to the TSW14J56. If there is more than one TSW14J56 connected to the host PC, select the appropriate serial number of the board to be programmed.

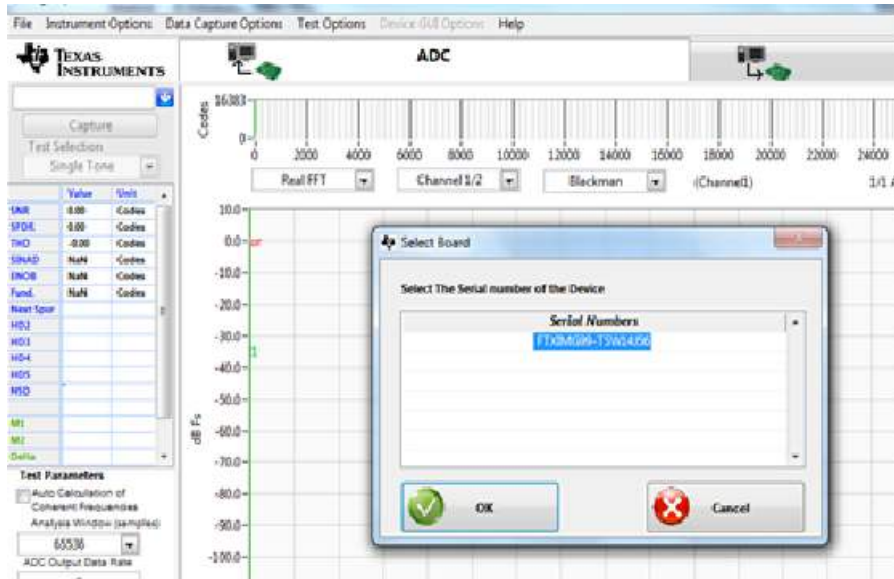

Figure 22. Connecting to TSW14J56

3. Select the *ADC* tab at the top of the GUI.
4. Use the *Select ADC* drop-down menu at the top left corner to select *ADC32RF80_LMF_8821* as [Figure 23](#) shows.

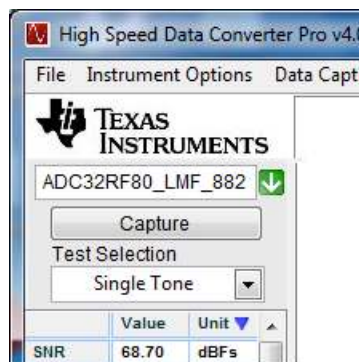

Figure 23. HSDC Pro Device Selection LMFS8821 Mode

5. When prompted to update the firmware for the ADC, click *Yes* and wait for the firmware to download to the TSW14J56. The following message appears while the firmware is downloading to the FPGA. (Downloading firmware does not mean the GUI is looking for newer revisions at ti.com. It simply means the bitfile for the firmware of the FPGA is being pushed to the FPGA through the USB cable.)

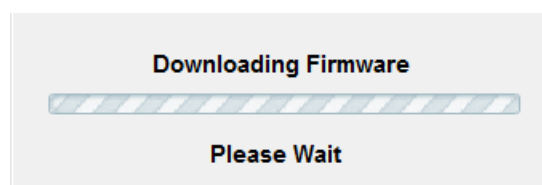

Figure 24. Download Firmware

6. After the firmware download has completed, enter “368.64M” into the *ADC Output Data Rate* field at the bottom left corner of the HSDC Pro GUI (2.94912 GHz sample rate divided by 8). A common mistake is to type 'm' instead of 'M' in which case the frequency entered is in milli-Hz instead of mega-Hz. Another common mistake is to omit the 'M' in which case the frequency entered is in Hz.
7. Select “Channel 1/8” in the channel select window located at the top middle of the GUI.
8. Click the *Instrument Options* menu at the top of HSDC Pro and select *Reset Board*.

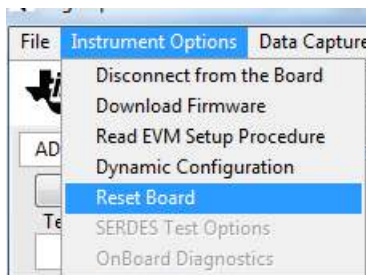

Figure 25. Resetting the TSW14J56

9. Click *Capture* in HSDC Pro to capture data from the ADC.
10. Select *Complex FFT*
11. The result should match the example capture in [Figure 27](#).
The input tone is seen to be near 60 MHz because the signal generator is set to 1.96 GHz while the NCO in the ADC is set to 1.90 GHz. So, the input tone is mixed down to 60 MHz. If the signal generators for the analog input tone and the clocking are synchronized, then HSDC Pro is able to locate the expected tone after the NCO and decimation by way of the popup parameter window of [Figure 26](#). If this popup is used, the frequency values entered must be exact.

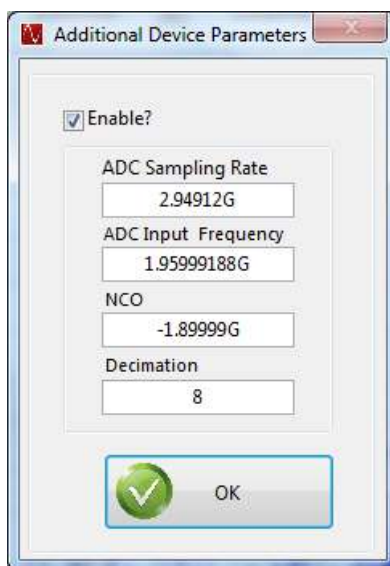

Figure 26. Popup Window for Setting HSDC Pro Decimation Factor and NCO Frequency

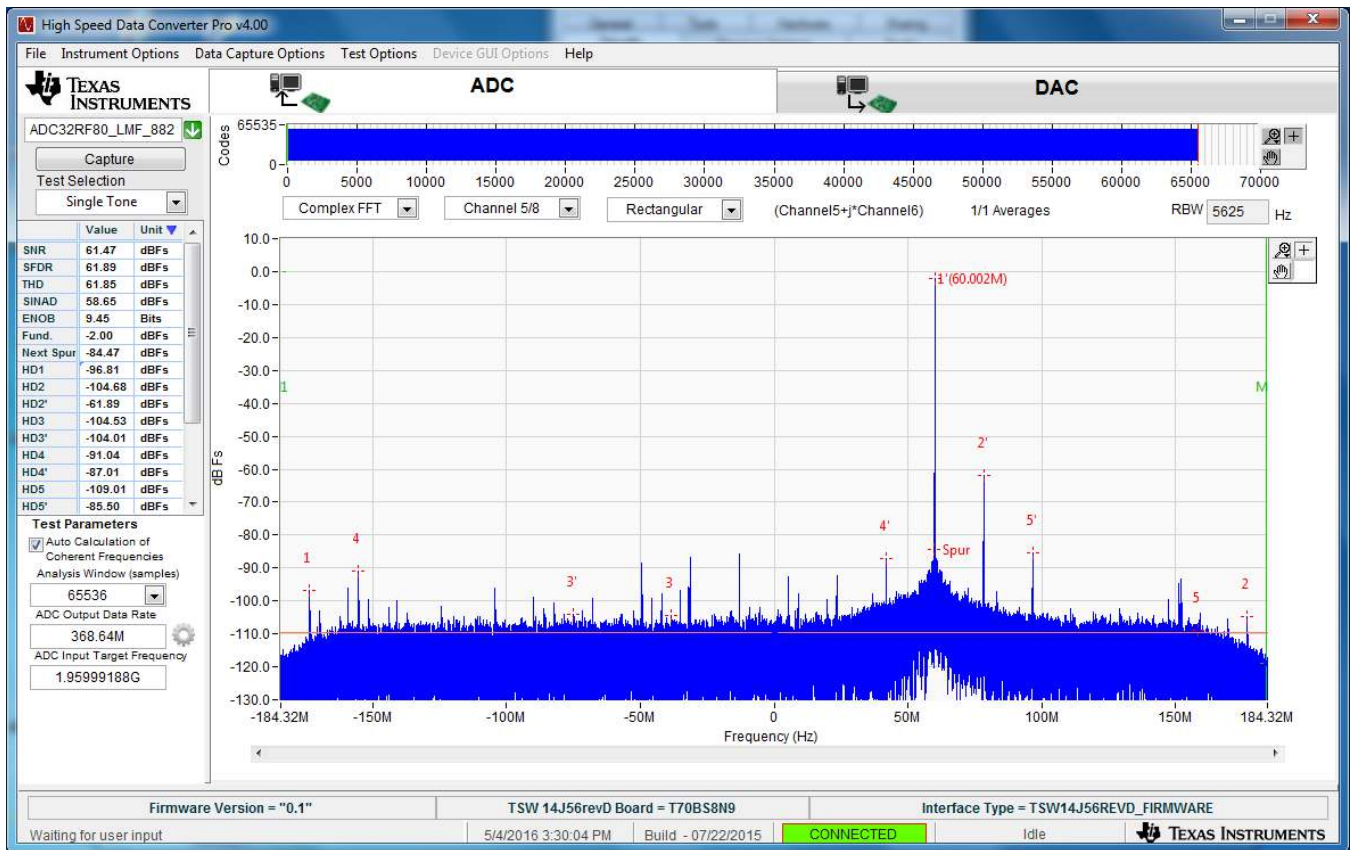

Figure 27. Example Capture From Channel A – 8x Decimation Mode

6 Quick-Start Procedure for Bypass LMFS8224 Mode in ADC32RF44 and Internal Clocking

This section lists the steps to configure ADC32RF44 in bypass mode. The steps are the same as that in [Section 3](#) with lower clock rate being the only difference.

6.1 TSW14J56

Please follow the steps listed in [Section 3.1](#).

6.2 ADC32RF44 EVM

Please follow the steps listed in [Section 3.2](#), with the exception of steps 5 and 6. Instead of supplying an external clock as was done in steps 5 and 6, the clocking is supplied from the onboard LMX2582 frequency synthesizer.

Fs = 2.4576 GHz, LMFS 8224 Example

This example captures data from channel A of the ADC32RF44 EVM sampling at 2.4576 GHz with a 1800-MHz input source. The ADC requires the device clock and SYSREF signals to be present **before** the ADC can be properly configured. Use the following steps to configure into this mode:

1. Open the ADC32RFxx EVM GUI.
2. Verify that the green *USB Status* indicator is lit. If it is not lit, click the **Reconnect?** button and check the *USB Status* indicator again. If it is still not lit then verify the EVM is connected to the computer through USB. Whenever the USB link is disturbed, the GUI must obtain a new handle to address the proper USB port, and the **Reconnect?** button does that.
3. On the PLL1 tab of the LMK04828 tab, press the *RESET* button.
4. On the ADC32RF44-EVM, press SW1 (*ADC RESET*) to provide a hardware reset to the ADC.
5. Click on the *Quick Setup* tab.
6. Select the *Nyquist Zone* for the input. It is the 2nd Nyquist in this example setup ($F_s = 2.4576\text{M}$, $F_{in} = 1800\text{M}$).

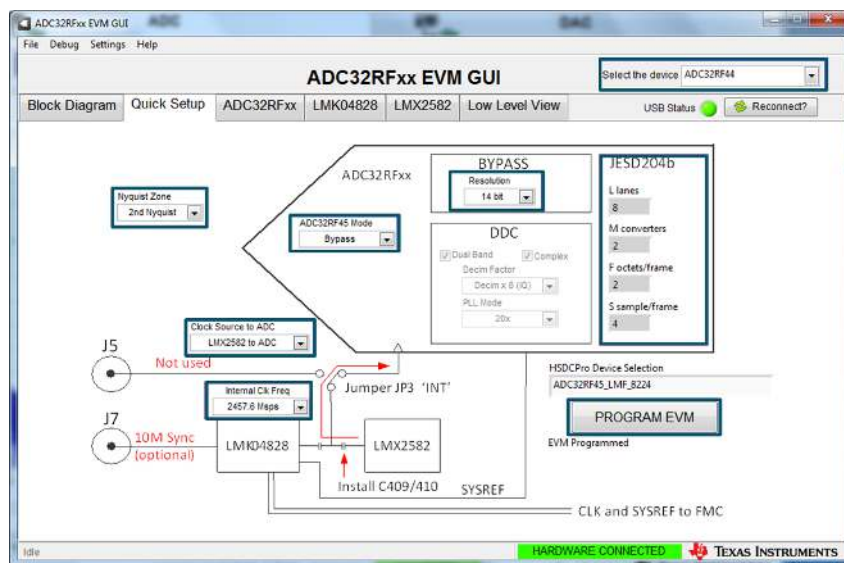

Figure 28. ADC32RF44-EVM Quick Setup View Bypass Mode

7. Select the *Clock Source to ADC*. In this example, LMX2582 is used to Clock the ADC.
8. Select the *Internal Clk Freq*. In this example, *2457.6 Msp/s* is selected.
9. Select *ADC32RF45 Mode*. In this example, *Bypass* is chosen.
10. Select *Resolution*. In this example, *14 bit* is selected.
11. Press **PROGRAM EVM**.
12. After pressing the **PROGRAM EVM** button, the device is configured in 14 bit LMFS8224 LMFS mode.

6.3 High Speed Data Converter Pro (HSDC Pro)

1. Open High Speed Data Converter Pro (v4.5 or newer) by going to *Start Menu* → *All Programs* → *Texas Instruments* → *High Speed Data Converter Pro*.
2. Click *OK* to connect to the TSW14J56. If there is more than one TSW14J56 connected to the host PC, select the appropriate serial number of the board to be programmed.
3. Select the *ADC* tab at the top of the GUI.
4. Use the *Select ADC* drop-down menu at the top left corner to select *ADC32RF45_LMF_8224*.

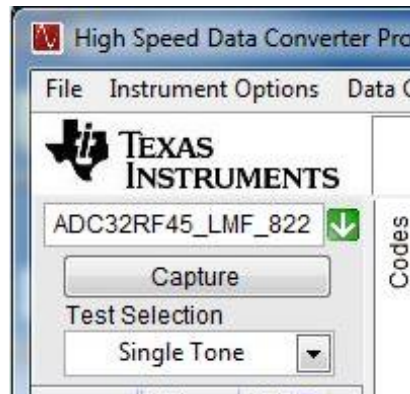

Figure 29. HSDC Pro Device Selection LMFS_8224 Mode

5. When prompted to update the firmware for the ADC, click *Yes* and wait for the firmware to download to the TSW14J56.
6. After the firmware download has completed, enter “2949.12M” into the *ADC Output Data Rate* field at the bottom left corner of the HSDC Pro GUI.
7. Select “Channel 1/2” in the channel select window located at the top middle of the GUI.
8. Click the *Instrument Options* menu at the top of HSDC Pro and select *Reset Board*.
9. Click **Capture** in HSDC Pro to capture data from the ADC.
10. The result should match the example capture in [Figure 30](#).

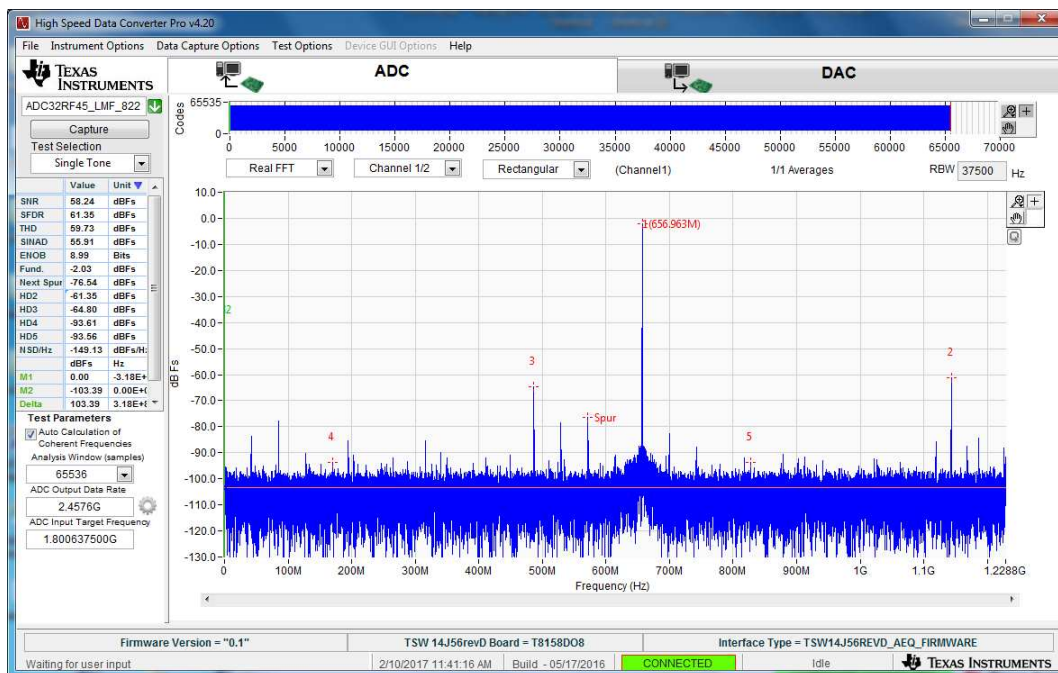

Figure 30. Example Capture from Channel A – LMFS8224 Mode

7 Quick-Start Procedure for Bypass LMFS 42810 Mode in ADC32RF42 With Internal Clocking

This section lists the steps to configure ADC32RF42 in 12-bit bypass mode. The steps are the same as those listed in [Section 3](#) with a lower clock rate. The ADC32RF42 is internally 2-way interleaved instead of 4-way interleaved as with the ADC32RF45, so many aspects of the operation of the EVM are halved. The maximum sample rate is 1536 MSPS, half of what the ADC32RF45 would support. The number of lanes used to transmit the data is halved when in bypass mode, so the LMFS 82820 lane configuration used by the ADC32RF45 becomes LMFS 42810 with the ADC32RF42. It is important to note that many of the decimation modes while using the DDC functions are **not** halved, and the number of lanes and the LMFS formats are the same as with the 4-way interleaved device. What **is** halved is the amount of effective decimation after setting the decimation factor. For example, to get a decimation factor of 8 with the ADC32RF42 the SPI register field would be set with the value that would previously have been used to get a decimation factor of 16 with the ADC32RF45. This may lead to confusion when using the SPI GUI with the ADC32RF42 and seeing a decimation factor or 16 being reported by the GUI when it is really decimation by 8 when the ADC32RF42 is being used. The configuration files supplied with the GUI for the ADC32RF42 already take this difference in decimation factor into account.

7.1 TSW14J56

Follow the steps listed in [Section 3.1](#).

7.2 ADC32RF42 EVM

Follow the steps listed in [Section 3.2](#), with the exception of steps 5 and 6. Instead of supplying an external clock as was done in steps 5 and 6, the clocking is supplied from the onboard LMX2582 frequency synthesizer.

F_s = 1.536 GHz, LMFS 42810 Example

This example captures data from channel A of the ADC32RF42 EVM sampling at 1.536 GHz with a 900-MHz input source. The ADC requires the device clock and SYSREF signals to be present **before** the ADC can be properly configured. Use the following steps to configure into this mode:

1. Open the ADC32RFxx EVM GUI.
2. Verify that the green *USB Status* indicator is lit. If it is not lit, click the **Reconnect?** button and check the *USB Status* indicator again. If it is still not lit then verify the EVM is connected to the computer through USB. Whenever the USB link is disturbed, the GUI must obtain a new handle to address the proper USB port, and the **Reconnect?** button does that. When the GUI is first launched or the **Reconnect?** button is used, the GUI will query the EVM for the type of EVM and the GUI displays the EVM type. In this case, ADC32RF42 should be displayed.
3. On the *PLL1* tab of the *LMK04828* tab, press the *RESET* button.
4. On the ADC32RF42-EVM, press SW1 (*ADC RESET*) to provide a hardware reset to the ADC.
5. Click on the *Quick Setup* tab.
6. Select the *Nyquist Zone* for the input. It is the 2nd Nyquist in this example setup ($F_s = 1.536$ M, $F_{in} = 900$ M).

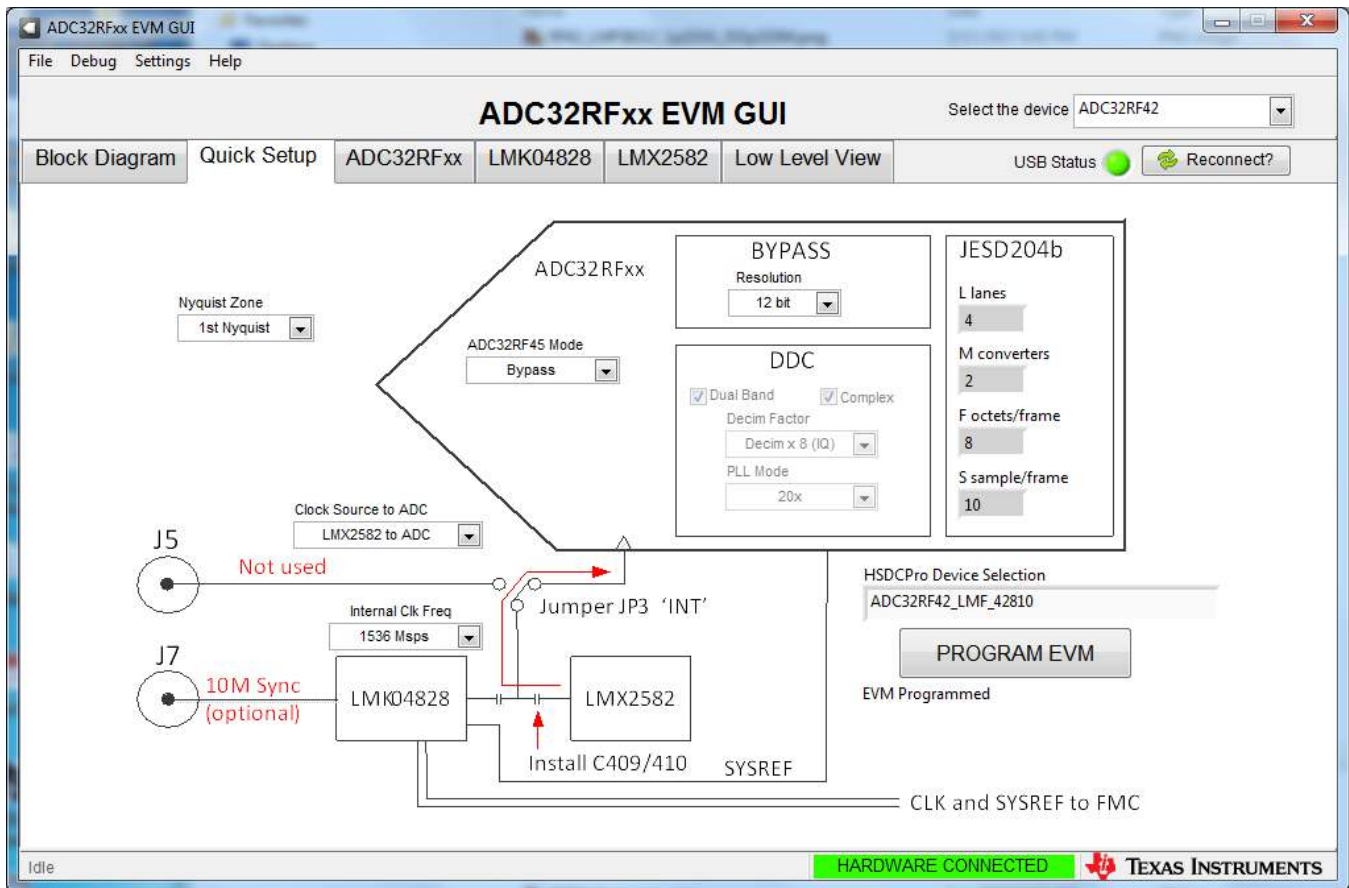

Figure 31. ADC32RF42-EVM Quick Setup View Bypass Mode

7. Select the *Clock Source to ADC*. In this example, LMX2582 is used to clock the ADC.
8. Select the *Internal Clk Freq*. In this example, 1536 Msp is selected. (Upon first launch of the GUI, the default clock rate selection may be grayed out if the clock rate is too fast or too slow for the ADC. If the GUI comes up with a grayed out selection then a valid selection must be chosen before pressing **PROGRAM EVM**, else an error message pops up saying that a config file for this clock rate could not be found.)
9. Select *ADC32RF45 Mode*. In this example, *Bypass* is chosen.
10. Select *Resolution*. In this example, 12 bit is selected.
11. Press **PROGRAM EVM**.
12. After pressing the **PROGRAM EVM** button, the device is configured in 12-bit, LMFS 42810 LMFS mode.

7.3 High Speed Data Converter Pro (HSDC Pro)

1. Open High Speed Data Converter Pro (v4.5 or newer) by going to *Start Menu* → *All Programs* → *Texas Instruments* → *High Speed Data Converter Pro*.
2. Click *OK* to connect to the TSW14J56. If there is more than one TSW14J56 connected to the host PC, select the appropriate serial number of the board to be programmed.
3. Select the *ADC* tab at the top of the GUI.
4. Use the *Select ADC* drop-down menu at the top left corner to select *ADC32RF45_LMF_42810*. (If this device selection is not available, a newer version of HSDCPro may need to be downloaded or a device .ini file for the mode may be obtained from TI and copied into the HSDCPro installation.)

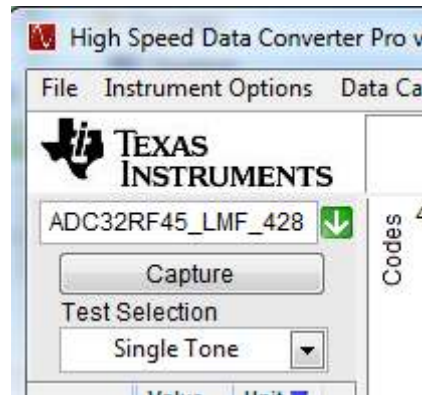

Figure 32. HSDC Pro Device Selection LMFS_42810 Mode

5. When prompted to update the firmware for the ADC, click *Yes* and wait for the firmware to download to the TSW14J56.
6. After the firmware download has completed, enter “1536M” into the *ADC Output Data Rate* field at the bottom left corner of the HSDC Pro GUI.
7. Select “Channel 1/2” in the channel select window located at the top middle of the GUI.
8. Click the *Instrument Options* menu at the top of HSDC Pro and select *Reset Board*.
9. Click **Capture** in HSDC Pro to capture data from the ADC.
10. The result should match the example capture in [Figure 33](#).

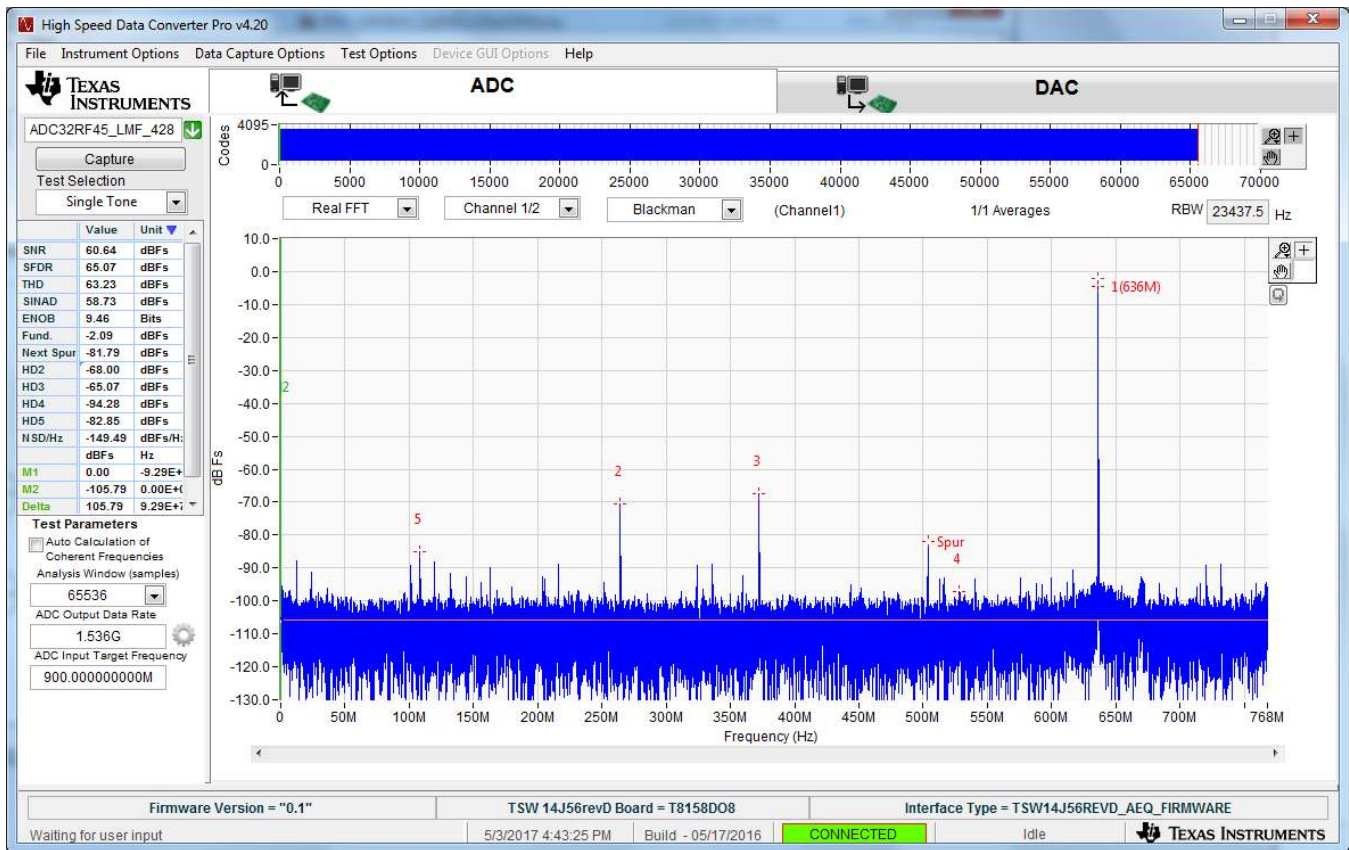

Figure 33. Example Capture from Channel A – LMFS42810 Mode

8 ADC32RFxx Internally Generated Clocking

8.1 ADC32RF45 EVM LMX2582 (or LMX2592) Clocking

Set up the TSW14J56 and ADC32RF45 the same way as it was set up for external clocking, but with the following modifications for internal clocking. Section 6 has already demonstrated the use of the LMX2582 for generating the clocking internal to the EVM, but this section covers more completely the use of either the LMX2582 or LMK04828 for clocking the ADC.

1. Verify the clocking selection jumper JP3 is set to the INT position to select the clock to the ADC to be generated on the EVM, either by the LMX2582 or the LMK04828. The default configuration for the EVM is for the LMX2582 to be the clock source to the ADC while in internal clock mode. (To select the LMK04828 as the ADC clock source, there are two AC coupling caps to unsolder and resolder in a different position.) There need not be any input to the J5 external clock SMA. If the LMK04828 is to be synchronized to the time base of the signal generator used for the analog input, then connect the 10-MHz sync signal from the signal generator to the LMK04828 reference input J7.
2. All but one step to configure the device in this mode are the same as previously described in Section 3.2. The only step different is the choice of *Clock Source to ADC*. That step is to be selected as shown in Figure 34. The rest of the steps in Section 3.2 must be followed.

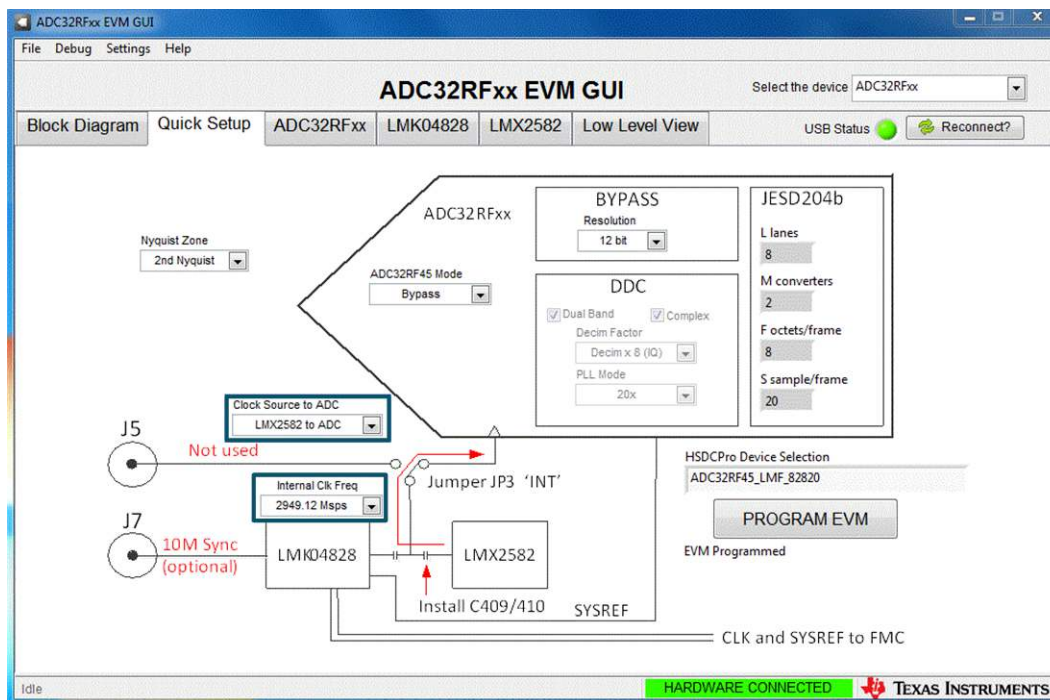

Figure 34. ADC32RFxx EVM GUI With LMX Clock Configuration

8.2 ADC32RF45 EVM LMK04828 Clocking

Set up the TSW14J56 and ADC32RF45 as before, with the following exceptions for internally generated clocking:

1. Verify the clocking selection jumper JP3 is set to the INT position to select the clock to the ADC to be generated on the EVM, either by the LMX2582 or the LMK04828. The default configuration for the EVM is for the LMX2582 to be the clock source to the ADC while in internal clock mode. Unsolder the two AC coupling caps from positions C409 and C410 and solder them into positions C431 and C432. This disconnects the ADC device clock from the LMX2582 outputs and instead connects the LMK04828 device clock output to be the clock source to the ADC. There need not be any input to the J5 external clock SMA. If the LMK04828 is to be synchronized to the timebase of the signal generator used for the analog input, then connect the 10-MHz sync signal from the signal generator to the LMK04828 reference input J7. The LMK04828 is still used to supply SYSREF to the ADC and Clock and SYSREF to the TSW14J56.
2. All but one step to configure the device in this mode are the same as previously described in [Section 3.2](#). The only step different is the choice of *Clock Source to ADC*. That step is to be selected as shown in [Figure 35](#). The rest of the steps in [Section 3.2](#) must be followed.

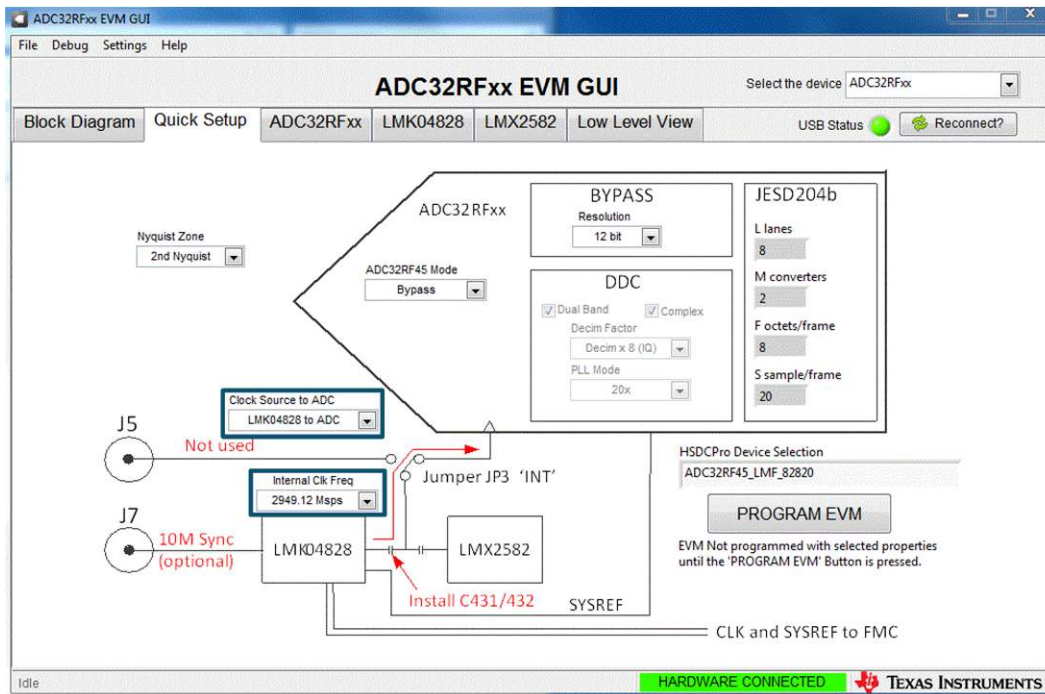

Figure 35. ADC32RFxx EVM GUI With LMK Clock Configuration

Revision History

NOTE: Page numbers for previous revisions may differ from page numbers in the current version.

Changes from D Revision (August 2017) to E Revision Page

- Changed [Figure 4](#)..... 10
-

Changes from C Revision (May 2017) to D Revision Page

- Added ADC32RF82 to list of supported devices in the abstract. 1
 - Added *Quick-Start Procedure for Digital DDC (Decimation Plus NCO) Mode in ADC32RF82* section. 13
-

STANDARD TERMS FOR EVALUATION MODULES

1. *Delivery:* TI delivers TI evaluation boards, kits, or modules, including any accompanying demonstration software, components, and/or documentation which may be provided together or separately (collectively, an "EVM" or "EVMs") to the User ("User") in accordance with the terms set forth herein. User's acceptance of the EVM is expressly subject to the following terms.
 - 1.1 EVMs are intended solely for product or software developers for use in a research and development setting to facilitate feasibility evaluation, experimentation, or scientific analysis of TI semiconductors products. EVMs have no direct function and are not finished products. EVMs shall not be directly or indirectly assembled as a part or subassembly in any finished product. For clarification, any software or software tools provided with the EVM ("Software") shall not be subject to the terms and conditions set forth herein but rather shall be subject to the applicable terms that accompany such Software
 - 1.2 EVMs are not intended for consumer or household use. EVMs may not be sold, sublicensed, leased, rented, loaned, assigned, or otherwise distributed for commercial purposes by Users, in whole or in part, or used in any finished product or production system.
2. *Limited Warranty and Related Remedies/Disclaimers:*
 - 2.1 These terms do not apply to Software. The warranty, if any, for Software is covered in the applicable Software License Agreement.
 - 2.2 TI warrants that the TI EVM will conform to TI's published specifications for ninety (90) days after the date TI delivers such EVM to User. Notwithstanding the foregoing, TI shall not be liable for a nonconforming EVM if (a) the nonconformity was caused by neglect, misuse or mistreatment by an entity other than TI, including improper installation or testing, or for any EVMs that have been altered or modified in any way by an entity other than TI, (b) the nonconformity resulted from User's design, specifications or instructions for such EVMs or improper system design, or (c) User has not paid on time. Testing and other quality control techniques are used to the extent TI deems necessary. TI does not test all parameters of each EVM. User's claims against TI under this Section 2 are void if User fails to notify TI of any apparent defects in the EVMs within ten (10) business days after delivery, or of any hidden defects with ten (10) business days after the defect has been detected.
 - 2.3 TI's sole liability shall be at its option to repair or replace EVMs that fail to conform to the warranty set forth above, or credit User's account for such EVM. TI's liability under this warranty shall be limited to EVMs that are returned during the warranty period to the address designated by TI and that are determined by TI not to conform to such warranty. If TI elects to repair or replace such EVM, TI shall have a reasonable time to repair such EVM or provide replacements. Repaired EVMs shall be warranted for the remainder of the original warranty period. Replaced EVMs shall be warranted for a new full ninety (90) day warranty period.

WARNING

Evaluation Kits are intended solely for use by technically qualified, professional electronics experts who are familiar with the dangers and application risks associated with handling electrical mechanical components, systems, and subsystems.

User shall operate the Evaluation Kit within TI's recommended guidelines and any applicable legal or environmental requirements as well as reasonable and customary safeguards. Failure to set up and/or operate the Evaluation Kit within TI's recommended guidelines may result in personal injury or death or property damage. Proper set up entails following TI's instructions for electrical ratings of interface circuits such as input, output and electrical loads.

NOTE:

EXPOSURE TO ELECTROSTATIC DISCHARGE (ESD) MAY CAUSE DEGRADATION OR FAILURE OF THE EVALUATION KIT; TI RECOMMENDS STORAGE OF THE EVALUATION KIT IN A PROTECTIVE ESD BAG.

3 Regulatory Notices:

3.1 United States

3.1.1 Notice applicable to EVMs not FCC-Approved:

FCC NOTICE: This kit is designed to allow product developers to evaluate electronic components, circuitry, or software associated with the kit to determine whether to incorporate such items in a finished product and software developers to write software applications for use with the end product. This kit is not a finished product and when assembled may not be resold or otherwise marketed unless all required FCC equipment authorizations are first obtained. Operation is subject to the condition that this product not cause harmful interference to licensed radio stations and that this product accept harmful interference. Unless the assembled kit is designed to operate under part 15, part 18 or part 95 of this chapter, the operator of the kit must operate under the authority of an FCC license holder or must secure an experimental authorization under part 5 of this chapter.

3.1.2 For EVMs annotated as FCC – FEDERAL COMMUNICATIONS COMMISSION Part 15 Compliant:

CAUTION

This device complies with part 15 of the FCC Rules. Operation is subject to the following two conditions: (1) This device may not cause harmful interference, and (2) this device must accept any interference received, including interference that may cause undesired operation.

Changes or modifications not expressly approved by the party responsible for compliance could void the user's authority to operate the equipment.

FCC Interference Statement for Class A EVM devices

NOTE: This equipment has been tested and found to comply with the limits for a Class A digital device, pursuant to part 15 of the FCC Rules. These limits are designed to provide reasonable protection against harmful interference when the equipment is operated in a commercial environment. This equipment generates, uses, and can radiate radio frequency energy and, if not installed and used in accordance with the instruction manual, may cause harmful interference to radio communications. Operation of this equipment in a residential area is likely to cause harmful interference in which case the user will be required to correct the interference at his own expense.

FCC Interference Statement for Class B EVM devices

NOTE: This equipment has been tested and found to comply with the limits for a Class B digital device, pursuant to part 15 of the FCC Rules. These limits are designed to provide reasonable protection against harmful interference in a residential installation. This equipment generates, uses and can radiate radio frequency energy and, if not installed and used in accordance with the instructions, may cause harmful interference to radio communications. However, there is no guarantee that interference will not occur in a particular installation. If this equipment does cause harmful interference to radio or television reception, which can be determined by turning the equipment off and on, the user is encouraged to try to correct the interference by one or more of the following measures:

- Reorient or relocate the receiving antenna.
- Increase the separation between the equipment and receiver.
- Connect the equipment into an outlet on a circuit different from that to which the receiver is connected.
- Consult the dealer or an experienced radio/TV technician for help.

3.2 Canada

3.2.1 For EVMs issued with an Industry Canada Certificate of Conformance to RSS-210 or RSS-247

Concerning EVMs Including Radio Transmitters:

This device complies with Industry Canada license-exempt RSSs. Operation is subject to the following two conditions:

(1) this device may not cause interference, and (2) this device must accept any interference, including interference that may cause undesired operation of the device.

Concernant les EVMs avec appareils radio:

Le présent appareil est conforme aux CNR d'Industrie Canada applicables aux appareils radio exempts de licence. L'exploitation est autorisée aux deux conditions suivantes: (1) l'appareil ne doit pas produire de brouillage, et (2) l'utilisateur de l'appareil doit accepter tout brouillage radioélectrique subi, même si le brouillage est susceptible d'en compromettre le fonctionnement.

Concerning EVMs Including Detachable Antennas:

Under Industry Canada regulations, this radio transmitter may only operate using an antenna of a type and maximum (or lesser) gain approved for the transmitter by Industry Canada. To reduce potential radio interference to other users, the antenna type and its gain should be so chosen that the equivalent isotropically radiated power (e.i.r.p.) is not more than that necessary for successful communication. This radio transmitter has been approved by Industry Canada to operate with the antenna types listed in the user guide with the maximum permissible gain and required antenna impedance for each antenna type indicated. Antenna types not included in this list, having a gain greater than the maximum gain indicated for that type, are strictly prohibited for use with this device.

Concernant les EVMs avec antennes détachables

Conformément à la réglementation d'Industrie Canada, le présent émetteur radio peut fonctionner avec une antenne d'un type et d'un gain maximal (ou inférieur) approuvé pour l'émetteur par Industrie Canada. Dans le but de réduire les risques de brouillage radioélectrique à l'intention des autres utilisateurs, il faut choisir le type d'antenne et son gain de sorte que la puissance isotrope rayonnée équivalente (p.i.r.e.) ne dépasse pas l'intensité nécessaire à l'établissement d'une communication satisfaisante. Le présent émetteur radio a été approuvé par Industrie Canada pour fonctionner avec les types d'antenne énumérés dans le manuel d'usage et ayant un gain admissible maximal et l'impédance requise pour chaque type d'antenne. Les types d'antenne non inclus dans cette liste, ou dont le gain est supérieur au gain maximal indiqué, sont strictement interdits pour l'exploitation de l'émetteur.

3.3 Japan

3.3.1 *Notice for EVMs delivered in Japan:* Please see http://www.tij.co.jp/lstds/ti_ja/general/eStore/notice_01.page 日本国内に輸入される評価用キット、ボードについては、次のところをご覧ください。
http://www.tij.co.jp/lstds/ti_ja/general/eStore/notice_01.page

3.3.2 *Notice for Users of EVMs Considered "Radio Frequency Products" in Japan:* EVMs entering Japan may not be certified by TI as conforming to Technical Regulations of Radio Law of Japan.

If User uses EVMs in Japan, not certified to Technical Regulations of Radio Law of Japan, User is required to follow the instructions set forth by Radio Law of Japan, which includes, but is not limited to, the instructions below with respect to EVMs (which for the avoidance of doubt are stated strictly for convenience and should be verified by User):

1. Use EVMs in a shielded room or any other test facility as defined in the notification #173 issued by Ministry of Internal Affairs and Communications on March 28, 2006, based on Sub-section 1.1 of Article 6 of the Ministry's Rule for Enforcement of Radio Law of Japan,
2. Use EVMs only after User obtains the license of Test Radio Station as provided in Radio Law of Japan with respect to EVMs, or
3. Use of EVMs only after User obtains the Technical Regulations Conformity Certification as provided in Radio Law of Japan with respect to EVMs. Also, do not transfer EVMs, unless User gives the same notice above to the transferee. Please note that if User does not follow the instructions above, User will be subject to penalties of Radio Law of Japan.

【無線電波を送信する製品の開発キットをお使いになる際の注意事項】 開発キットの中には技術基準適合証明を受けていないものがあります。技術適合証明を受けていないものご使用に際しては、電波法遵守のため、以下のいずれかの措置を取っていただく必要がありますのでご注意ください。

1. 電波法施行規則第6条第1項第1号に基づく平成18年3月28日総務省告示第173号で定められた電波暗室等の試験設備でご使用いただく。
2. 実験局の免許を取得後ご使用いただく。
3. 技術基準適合証明を取得後ご使用いただく。

なお、本製品は、上記の「ご使用にあたっての注意」を譲渡先、移転先に通知しない限り、譲渡、移転できないものとします。

上記を遵守頂けない場合は、電波法の罰則が適用される可能性があることをご留意ください。日本テキサス・インスツルメンツ株式会社
東京都新宿区西新宿 6 丁目 2 4 番 1 号
西新宿三井ビル

3.3.3 *Notice for EVMs for Power Line Communication:* Please see http://www.tij.co.jp/lstds/ti_ja/general/eStore/notice_02.page
電力線搬送波通信についての開発キットをお使いになる際の注意事項については、次のところをご覧ください。http://www.tij.co.jp/lstds/ti_ja/general/eStore/notice_02.page

3.4 European Union

3.4.1 *For EVMs subject to EU Directive 2014/30/EU (Electromagnetic Compatibility Directive):*

This is a class A product intended for use in environments other than domestic environments that are connected to a low-voltage power-supply network that supplies buildings used for domestic purposes. In a domestic environment this product may cause radio interference in which case the user may be required to take adequate measures.

-
- 4 *EVM Use Restrictions and Warnings:*
- 4.1 EVMS ARE NOT FOR USE IN FUNCTIONAL SAFETY AND/OR SAFETY CRITICAL EVALUATIONS, INCLUDING BUT NOT LIMITED TO EVALUATIONS OF LIFE SUPPORT APPLICATIONS.
- 4.2 User must read and apply the user guide and other available documentation provided by TI regarding the EVM prior to handling or using the EVM, including without limitation any warning or restriction notices. The notices contain important safety information related to, for example, temperatures and voltages.
- 4.3 *Safety-Related Warnings and Restrictions:*
- 4.3.1 User shall operate the EVM within TI's recommended specifications and environmental considerations stated in the user guide, other available documentation provided by TI, and any other applicable requirements and employ reasonable and customary safeguards. Exceeding the specified performance ratings and specifications (including but not limited to input and output voltage, current, power, and environmental ranges) for the EVM may cause personal injury or death, or property damage. If there are questions concerning performance ratings and specifications, User should contact a TI field representative prior to connecting interface electronics including input power and intended loads. Any loads applied outside of the specified output range may also result in unintended and/or inaccurate operation and/or possible permanent damage to the EVM and/or interface electronics. Please consult the EVM user guide prior to connecting any load to the EVM output. If there is uncertainty as to the load specification, please contact a TI field representative. During normal operation, even with the inputs and outputs kept within the specified allowable ranges, some circuit components may have elevated case temperatures. These components include but are not limited to linear regulators, switching transistors, pass transistors, current sense resistors, and heat sinks, which can be identified using the information in the associated documentation. When working with the EVM, please be aware that the EVM may become very warm.
- 4.3.2 EVMs are intended solely for use by technically qualified, professional electronics experts who are familiar with the dangers and application risks associated with handling electrical mechanical components, systems, and subsystems. User assumes all responsibility and liability for proper and safe handling and use of the EVM by User or its employees, affiliates, contractors or designees. User assumes all responsibility and liability to ensure that any interfaces (electronic and/or mechanical) between the EVM and any human body are designed with suitable isolation and means to safely limit accessible leakage currents to minimize the risk of electrical shock hazard. User assumes all responsibility and liability for any improper or unsafe handling or use of the EVM by User or its employees, affiliates, contractors or designees.
- 4.4 User assumes all responsibility and liability to determine whether the EVM is subject to any applicable international, federal, state, or local laws and regulations related to User's handling and use of the EVM and, if applicable, User assumes all responsibility and liability for compliance in all respects with such laws and regulations. User assumes all responsibility and liability for proper disposal and recycling of the EVM consistent with all applicable international, federal, state, and local requirements.
5. *Accuracy of Information:* To the extent TI provides information on the availability and function of EVMs, TI attempts to be as accurate as possible. However, TI does not warrant the accuracy of EVM descriptions, EVM availability or other information on its websites as accurate, complete, reliable, current, or error-free.
6. *Disclaimers:*
- 6.1 EXCEPT AS SET FORTH ABOVE, EVMS AND ANY MATERIALS PROVIDED WITH THE EVM (INCLUDING, BUT NOT LIMITED TO, REFERENCE DESIGNS AND THE DESIGN OF THE EVM ITSELF) ARE PROVIDED "AS IS" AND "WITH ALL FAULTS." TI DISCLAIMS ALL OTHER WARRANTIES, EXPRESS OR IMPLIED, REGARDING SUCH ITEMS, INCLUDING BUT NOT LIMITED TO ANY EPIDEMIC FAILURE WARRANTY OR IMPLIED WARRANTIES OF MERCHANTABILITY OR FITNESS FOR A PARTICULAR PURPOSE OR NON-INFRINGEMENT OF ANY THIRD PARTY PATENTS, COPYRIGHTS, TRADE SECRETS OR OTHER INTELLECTUAL PROPERTY RIGHTS.
- 6.2 EXCEPT FOR THE LIMITED RIGHT TO USE THE EVM SET FORTH HEREIN, NOTHING IN THESE TERMS SHALL BE CONSTRUED AS GRANTING OR CONFERRING ANY RIGHTS BY LICENSE, PATENT, OR ANY OTHER INDUSTRIAL OR INTELLECTUAL PROPERTY RIGHT OF TI, ITS SUPPLIERS/LICENSORS OR ANY OTHER THIRD PARTY, TO USE THE EVM IN ANY FINISHED END-USER OR READY-TO-USE FINAL PRODUCT, OR FOR ANY INVENTION, DISCOVERY OR IMPROVEMENT, REGARDLESS OF WHEN MADE, CONCEIVED OR ACQUIRED.
7. *USER'S INDEMNITY OBLIGATIONS AND REPRESENTATIONS.* USER WILL DEFEND, INDEMNIFY AND HOLD TI, ITS LICENSORS AND THEIR REPRESENTATIVES HARMLESS FROM AND AGAINST ANY AND ALL CLAIMS, DAMAGES, LOSSES, EXPENSES, COSTS AND LIABILITIES (COLLECTIVELY, "CLAIMS") ARISING OUT OF OR IN CONNECTION WITH ANY HANDLING OR USE OF THE EVM THAT IS NOT IN ACCORDANCE WITH THESE TERMS. THIS OBLIGATION SHALL APPLY WHETHER CLAIMS ARISE UNDER STATUTE, REGULATION, OR THE LAW OF TORT, CONTRACT OR ANY OTHER LEGAL THEORY, AND EVEN IF THE EVM FAILS TO PERFORM AS DESCRIBED OR EXPECTED.

8. *Limitations on Damages and Liability:*

8.1 *General Limitations.* IN NO EVENT SHALL TI BE LIABLE FOR ANY SPECIAL, COLLATERAL, INDIRECT, PUNITIVE, INCIDENTAL, CONSEQUENTIAL, OR EXEMPLARY DAMAGES IN CONNECTION WITH OR ARISING OUT OF THESE TERMS OR THE USE OF THE EVMS , REGARDLESS OF WHETHER TI HAS BEEN ADVISED OF THE POSSIBILITY OF SUCH DAMAGES. EXCLUDED DAMAGES INCLUDE, BUT ARE NOT LIMITED TO, COST OF REMOVAL OR REINSTALLATION, ANCILLARY COSTS TO THE PROCUREMENT OF SUBSTITUTE GOODS OR SERVICES, RETESTING, OUTSIDE COMPUTER TIME, LABOR COSTS, LOSS OF GOODWILL, LOSS OF PROFITS, LOSS OF SAVINGS, LOSS OF USE, LOSS OF DATA, OR BUSINESS INTERRUPTION. NO CLAIM, SUIT OR ACTION SHALL BE BROUGHT AGAINST TI MORE THAN TWELVE (12) MONTHS AFTER THE EVENT THAT GAVE RISE TO THE CAUSE OF ACTION HAS OCCURRED.

8.2 *Specific Limitations.* IN NO EVENT SHALL TI'S AGGREGATE LIABILITY FROM ANY USE OF AN EVM PROVIDED HEREUNDER, INCLUDING FROM ANY WARRANTY, INDEMNITY OR OTHER OBLIGATION ARISING OUT OF OR IN CONNECTION WITH THESE TERMS, , EXCEED THE TOTAL AMOUNT PAID TO TI BY USER FOR THE PARTICULAR EVM(S) AT ISSUE DURING THE PRIOR TWELVE (12) MONTHS WITH RESPECT TO WHICH LOSSES OR DAMAGES ARE CLAIMED. THE EXISTENCE OF MORE THAN ONE CLAIM SHALL NOT ENLARGE OR EXTEND THIS LIMIT.

9. *Return Policy.* Except as otherwise provided, TI does not offer any refunds, returns, or exchanges. Furthermore, no return of EVM(s) will be accepted if the package has been opened and no return of the EVM(s) will be accepted if they are damaged or otherwise not in a resalable condition. If User feels it has been incorrectly charged for the EVM(s) it ordered or that delivery violates the applicable order, User should contact TI. All refunds will be made in full within thirty (30) working days from the return of the components(s), excluding any postage or packaging costs.

10. *Governing Law:* These terms and conditions shall be governed by and interpreted in accordance with the laws of the State of Texas, without reference to conflict-of-laws principles. User agrees that non-exclusive jurisdiction for any dispute arising out of or relating to these terms and conditions lies within courts located in the State of Texas and consents to venue in Dallas County, Texas. Notwithstanding the foregoing, any judgment may be enforced in any United States or foreign court, and TI may seek injunctive relief in any United States or foreign court.

Mailing Address: Texas Instruments, Post Office Box 655303, Dallas, Texas 75265
Copyright © 2019, Texas Instruments Incorporated

IMPORTANT NOTICE AND DISCLAIMER

TI PROVIDES TECHNICAL AND RELIABILITY DATA (INCLUDING DATASHEETS), DESIGN RESOURCES (INCLUDING REFERENCE DESIGNS), APPLICATION OR OTHER DESIGN ADVICE, WEB TOOLS, SAFETY INFORMATION, AND OTHER RESOURCES "AS IS" AND WITH ALL FAULTS, AND DISCLAIMS ALL WARRANTIES, EXPRESS AND IMPLIED, INCLUDING WITHOUT LIMITATION ANY IMPLIED WARRANTIES OF MERCHANTABILITY, FITNESS FOR A PARTICULAR PURPOSE OR NON-INFRINGEMENT OF THIRD PARTY INTELLECTUAL PROPERTY RIGHTS.

These resources are intended for skilled developers designing with TI products. You are solely responsible for (1) selecting the appropriate TI products for your application, (2) designing, validating and testing your application, and (3) ensuring your application meets applicable standards, and any other safety, security, or other requirements. These resources are subject to change without notice. TI grants you permission to use these resources only for development of an application that uses the TI products described in the resource. Other reproduction and display of these resources is prohibited. No license is granted to any other TI intellectual property right or to any third party intellectual property right. TI disclaims responsibility for, and you will fully indemnify TI and its representatives against, any claims, damages, costs, losses, and liabilities arising out of your use of these resources.

TI's products are provided subject to TI's Terms of Sale (www.ti.com/legal/termsofsale.html) or other applicable terms available either on ti.com or provided in conjunction with such TI products. TI's provision of these resources does not expand or otherwise alter TI's applicable warranties or warranty disclaimers for TI products.

Mailing Address: Texas Instruments, Post Office Box 655303, Dallas, Texas 75265
Copyright © 2020, Texas Instruments Incorporated