

Important notice

Dear Customer,

On 7 February 2017 the former NXP Standard Product business became a new company with the tradename **Nexperia**. Nexperia is an industry leading supplier of Discrete, Logic and PowerMOS semiconductors with its focus on the automotive, industrial, computing, consumer and wearable application markets

In data sheets and application notes which still contain NXP or Philips Semiconductors references, use the references to Nexperia, as shown below.

Instead of <http://www.nxp.com>, <http://www.philips.com/> or <http://www.semiconductors.philips.com/>, use <http://www.nexperia.com>

Instead of sales.addresses@www.nxp.com or sales.addresses@www.semiconductors.philips.com, use salesaddresses@nexperia.com (email)

Replace the copyright notice at the bottom of each page or elsewhere in the document, depending on the version, as shown below:

- © NXP N.V. (year). All rights reserved or © Koninklijke Philips Electronics N.V. (year). All rights reserved

Should be replaced with:

- © **Nexperia B.V. (year). All rights reserved.**

If you have any questions related to the data sheet, please contact our nearest sales office via e-mail or telephone (details via salesaddresses@nexperia.com). Thank you for your cooperation and understanding,

Kind regards,

Team Nexperia

PEMD17; PUMD17

NPN/PNP resistor-equipped transistors;
R1 = 47 k Ω , R2 = 22 k Ω

Rev. 03 — 24 January 2005

Product data sheet

1. Product profile

1.1 General description

NPN/PNP resistor-equipped transistors.

Table 1: Product overview

Type number	Package		PNP/PNP complement	NPN/PNP complement
	Philips	JEITA		
PEMD17	SOT666	-	PEMB17	PEMH17
PUMD17	SOT363	SC-88	PUMB17	PUMH17

1.2 Features

- Built-in bias resistors
- Simplifies circuit design
- Reduces component count
- Reduces pick and place cost

1.3 Applications

- Low current peripheral driver
- Control of IC inputs
- Replacement of general-purpose transistors in digital applications

1.4 Quick reference data

Table 2: Quick reference data

Symbol	Parameter	Conditions	Min	Typ	Max	Unit
V _{CEO}	collector-emitter voltage	open base	-	-	50	V
I _O	output current (DC)		-	-	100	mA
R1	bias resistor 1 (input)		33	47	61	k Ω
R2/R1	bias resistor ratio		0.37	0.47	0.57	

PHILIPS

2. Pinning information

Table 3: Pinning

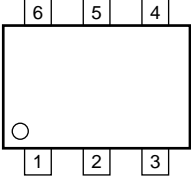
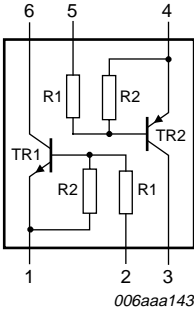
Pin	Description	Simplified outline	Symbol
1	GND (emitter) TR1	 001aab555	 006aaa143
2	input (base) TR1		
3	output (collector) TR2		
4	GND (emitter) TR2		
5	input (base) TR2		
6	output (collector) TR1		

3. Ordering information

Table 4: Ordering information

Type number	Package		Version
	Name	Description	
PEMD17	-	plastic surface mounted package; 6 leads	SOT666
PUMD17	SC-88	plastic surface mounted package; 6 leads	SOT363

4. Marking

Table 5: Marking codes

Type number	Marking code ^[1]
PEMD17	5N
PUMD17	D9*

- [1] * = -: made in Hong Kong
 * = p: made in Hong Kong
 * = t: made in Malaysia
 * = W: made in China

5. Limiting values

Table 6: Limiting values

In accordance with the Absolute Maximum Rating System (IEC 60134).

Symbol	Parameter	Conditions	Min	Max	Unit	
Per transistor; for the PNP transistor with negative polarity						
V _{CBO}	collector-base voltage	open emitter	-	50	V	
V _{CEO}	collector-emitter voltage	open base	-	50	V	
V _{EBO}	emitter-base voltage	open collector	-	10	V	
V _I	input voltage TR1					
	positive		-	+40	V	
	negative		-	-10	V	
V _I	input voltage TR2					
	positive		-	+10	V	
	negative		-	-40	V	
I _O	output current (DC)		-	100	mA	
I _{CM}	peak collector current		-	100	mA	
P _{tot}	total power dissipation	T _{amb} ≤ 25 °C				
	SOT363		[1]	-	200	mW
	SOT666		[1] [2]	-	200	mW
T _{stg}	storage temperature		-65	+150	°C	
T _j	junction temperature		-	150	°C	
T _{amb}	ambient temperature		-65	+150	°C	
Per device						
P _{tot}	total power dissipation	T _{amb} ≤ 25 °C				
	SOT363		[1]	-	300	mW
	SOT666		[1] [2]	-	300	mW

[1] Device mounted on a FR4 printed-circuit board, single-sided copper, standard footprint.

[2] Reflow soldering is the only recommended soldering method.

6. Thermal characteristics

Table 7: Thermal characteristics

Symbol	Parameter	Conditions	Min	Typ	Max	Unit
Per transistor						
$R_{th(j-a)}$	thermal resistance from junction to ambient	$T_{amb} \leq 25\text{ °C}$				
	SOT363		[1]	-	625	K/W
	SOT666		[1] [2]	-	625	K/W
Per device						
$R_{th(j-a)}$	thermal resistance from junction to ambient	$T_{amb} \leq 25\text{ °C}$				
	SOT363		[1]	-	416	K/W
	SOT666		[1] [2]	-	416	K/W

[1] Device mounted on a FR4 printed-circuit board, single-sided copper, standard footprint.

[2] Reflow soldering is the only recommended soldering method.

7. Characteristics

Table 8: Characteristics

$T_{amb} = 25\text{ °C}$ unless otherwise specified.

Symbol	Parameter	Conditions	Min	Typ	Max	Unit	
Per transistor; for the PNP transistor with negative polarity							
I_{CBO}	collector-base cut-off current	$V_{CB} = 50\text{ V}; I_E = 0\text{ A}$	-	-	100	nA	
I_{CEO}	collector-emitter cut-off current	$V_{CE} = 30\text{ V}; I_B = 0\text{ A}$	-	-	1	μA	
		$V_{CE} = 30\text{ V}; I_B = 0\text{ A}; T_j = 150\text{ °C}$	-	-	50	μA	
I_{EBO}	emitter-base cut-off current	$V_{EB} = 5\text{ V}; I_C = 0\text{ A}$	-	-	110	μA	
h_{FE}	DC current gain	$V_{CE} = 5\text{ V}; I_C = 5\text{ mA}$	60	-	-		
V_{CEsat}	collector-emitter saturation voltage	$I_C = 10\text{ mA}; I_B = 0.5\text{ mA}$	-	-	150	mV	
$V_{I(off)}$	off-state input voltage	$V_{CE} = 5\text{ V}; I_C = 100\text{ }\mu\text{A}$	-	1.7	1.2	V	
$V_{I(on)}$	on-state input voltage	$V_{CE} = 0.3\text{ V}; I_C = 2\text{ mA}$	4	2.7	-	V	
R1	bias resistor 1 (input)		33	47	61	kΩ	
R2/R1	bias resistor ratio		0.37	0.47	0.57		
C_c	collector capacitance	$V_{CB} = -10\text{ V}; I_E = i_e = 0\text{ A}; f = 1\text{ MHz}$					
			TR1 (NPN)	-	-	2.5	pF
			TR2 (PNP)	-	-	3	pF

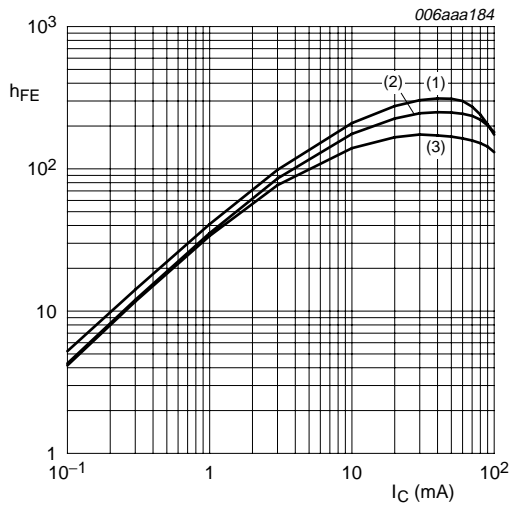

$V_{CE} = 5\text{ V}$
 (1) $T_{amb} = 100\text{ °C}$
 (2) $T_{amb} = 25\text{ °C}$
 (3) $T_{amb} = -40\text{ °C}$

Fig 1. TR1 (NPN): DC current gain as a function of collector current; typical values

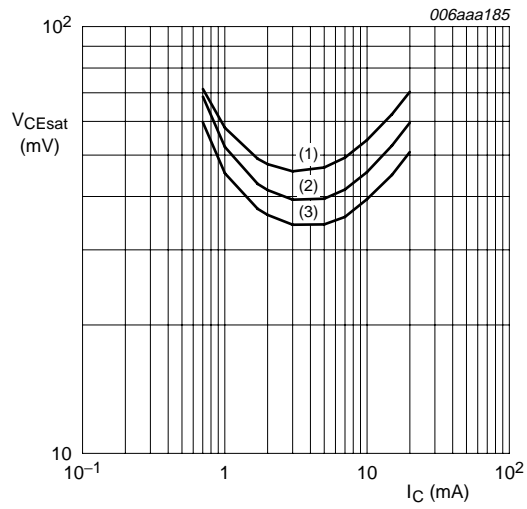

$I_C/I_B = 20$
 (1) $T_{amb} = 100\text{ °C}$
 (2) $T_{amb} = 25\text{ °C}$
 (3) $T_{amb} = -40\text{ °C}$

Fig 2. TR1 (NPN): Collector-emitter saturation voltage as a function of collector current; typical values

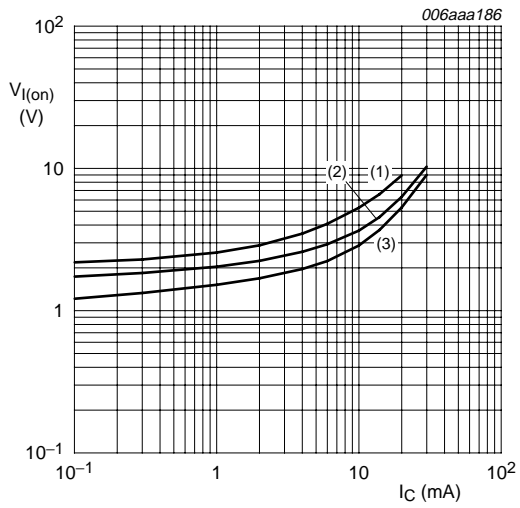

$V_{CE} = 0.3\text{ V}$
 (1) $T_{amb} = -40\text{ °C}$
 (2) $T_{amb} = 25\text{ °C}$
 (3) $T_{amb} = 100\text{ °C}$

Fig 3. TR1 (NPN): On-state input voltage as a function of collector current; typical values

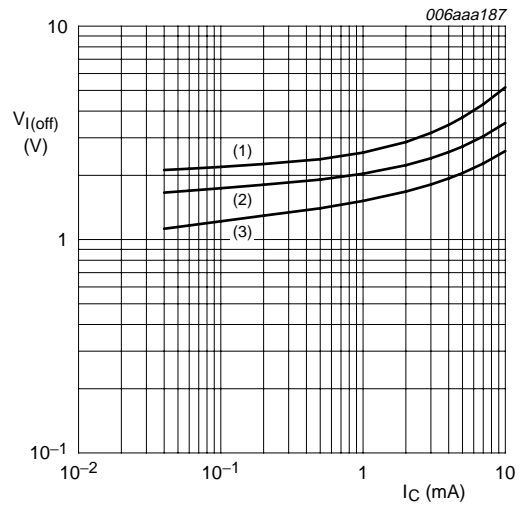

$V_{CE} = 5\text{ V}$
 (1) $T_{amb} = -40\text{ °C}$
 (2) $T_{amb} = 25\text{ °C}$
 (3) $T_{amb} = 100\text{ °C}$

Fig 4. TR1 (NPN): Off-state input voltage as a function of collector current; typical values

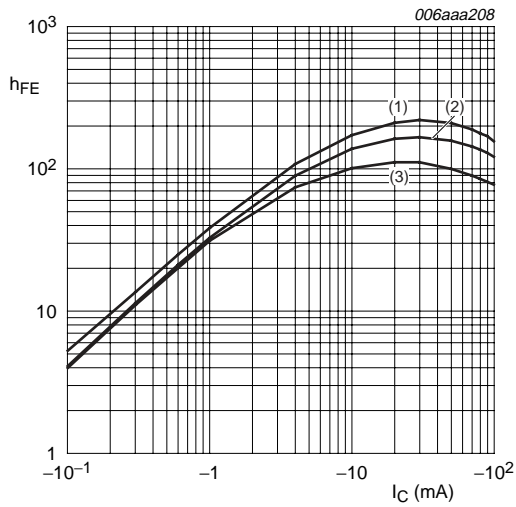

$V_{CE} = -5 \text{ V}$
 (1) $T_{amb} = 100 \text{ }^\circ\text{C}$
 (2) $T_{amb} = 25 \text{ }^\circ\text{C}$
 (3) $T_{amb} = -40 \text{ }^\circ\text{C}$

Fig 5. TR2 (PNP): DC current gain as a function of collector current; typical values

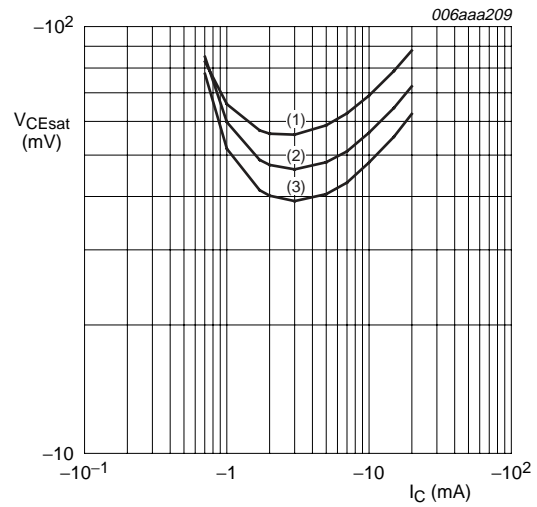

$I_C/I_B = 20$
 (1) $T_{amb} = 100 \text{ }^\circ\text{C}$
 (2) $T_{amb} = 25 \text{ }^\circ\text{C}$
 (3) $T_{amb} = -40 \text{ }^\circ\text{C}$

Fig 6. TR2 (PNP): Collector-emitter saturation voltage as a function of collector current; typical values

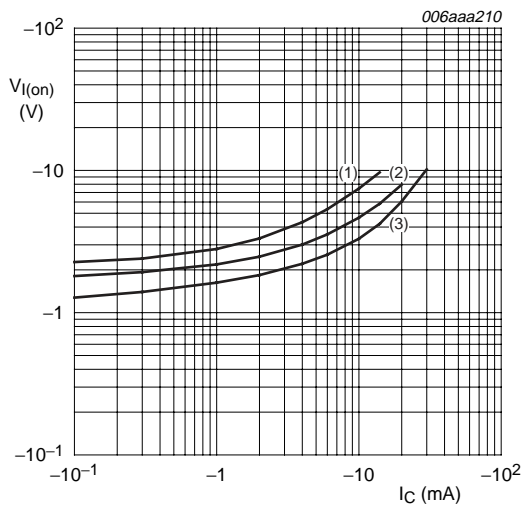

$V_{CE} = -0.3 \text{ V}$
 (1) $T_{amb} = -40 \text{ }^\circ\text{C}$
 (2) $T_{amb} = 25 \text{ }^\circ\text{C}$
 (3) $T_{amb} = 100 \text{ }^\circ\text{C}$

Fig 7. TR2 (PNP): On-state input voltage as a function of collector current; typical values

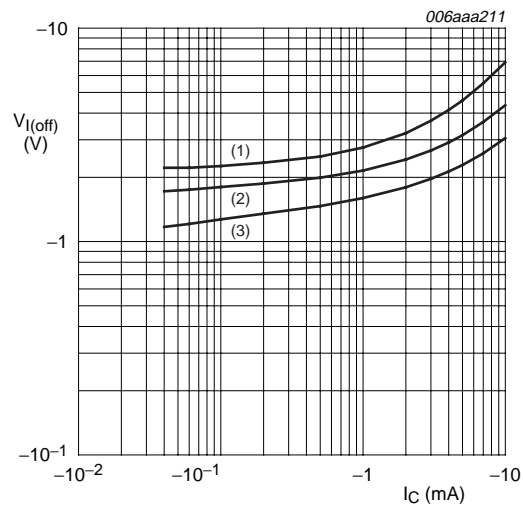

$V_{CE} = -5 \text{ V}$
 (1) $T_{amb} = -40 \text{ }^\circ\text{C}$
 (2) $T_{amb} = 25 \text{ }^\circ\text{C}$
 (3) $T_{amb} = 100 \text{ }^\circ\text{C}$

Fig 8. TR2 (PNP): Off-state input voltage as a function of collector current; typical values

8. Package outline

Plastic surface mounted package; 6 leads

SOT363

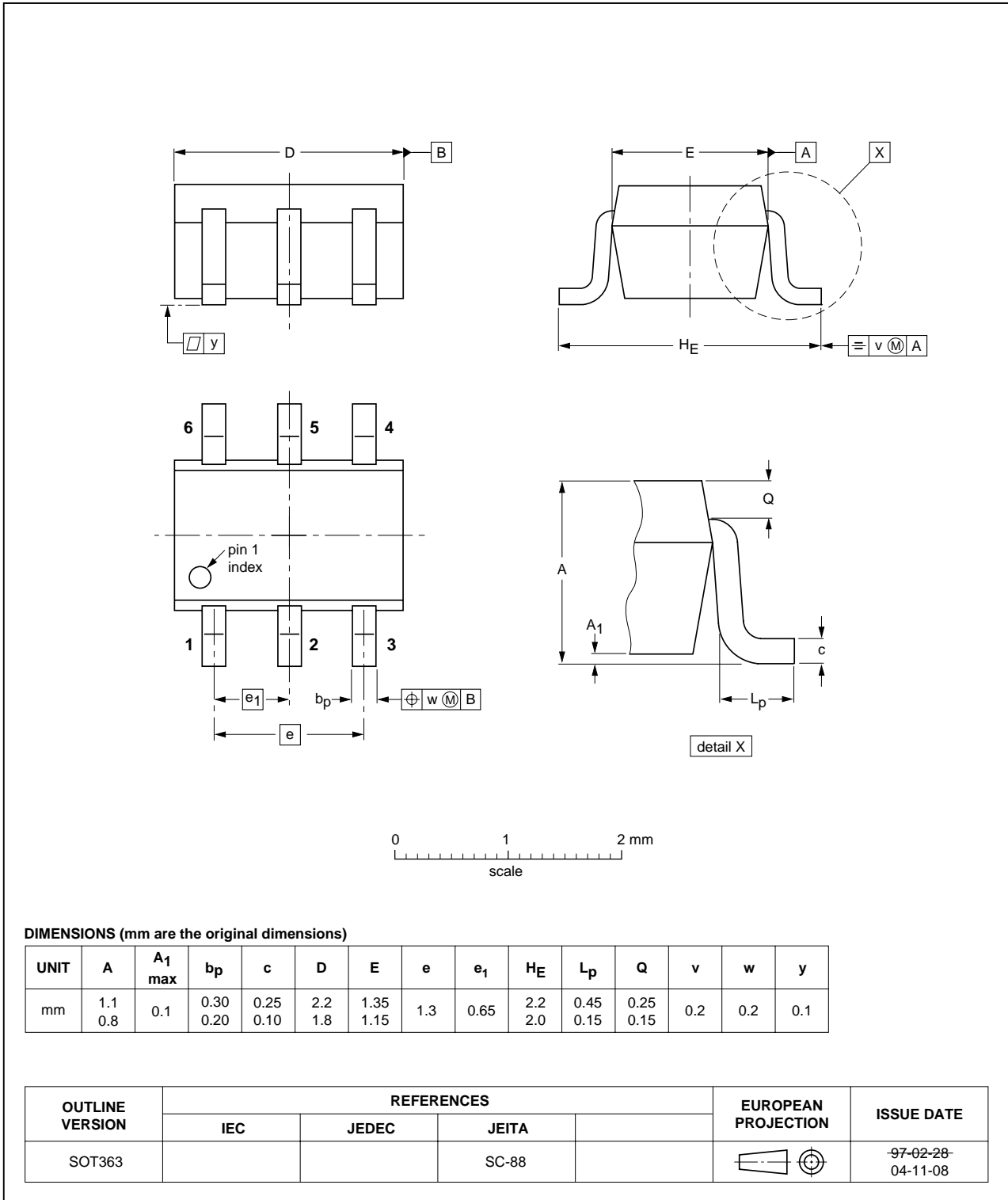

Fig 9. Package outline SOT363 (SC-88)

Plastic surface mounted package; 6 leads

SOT666

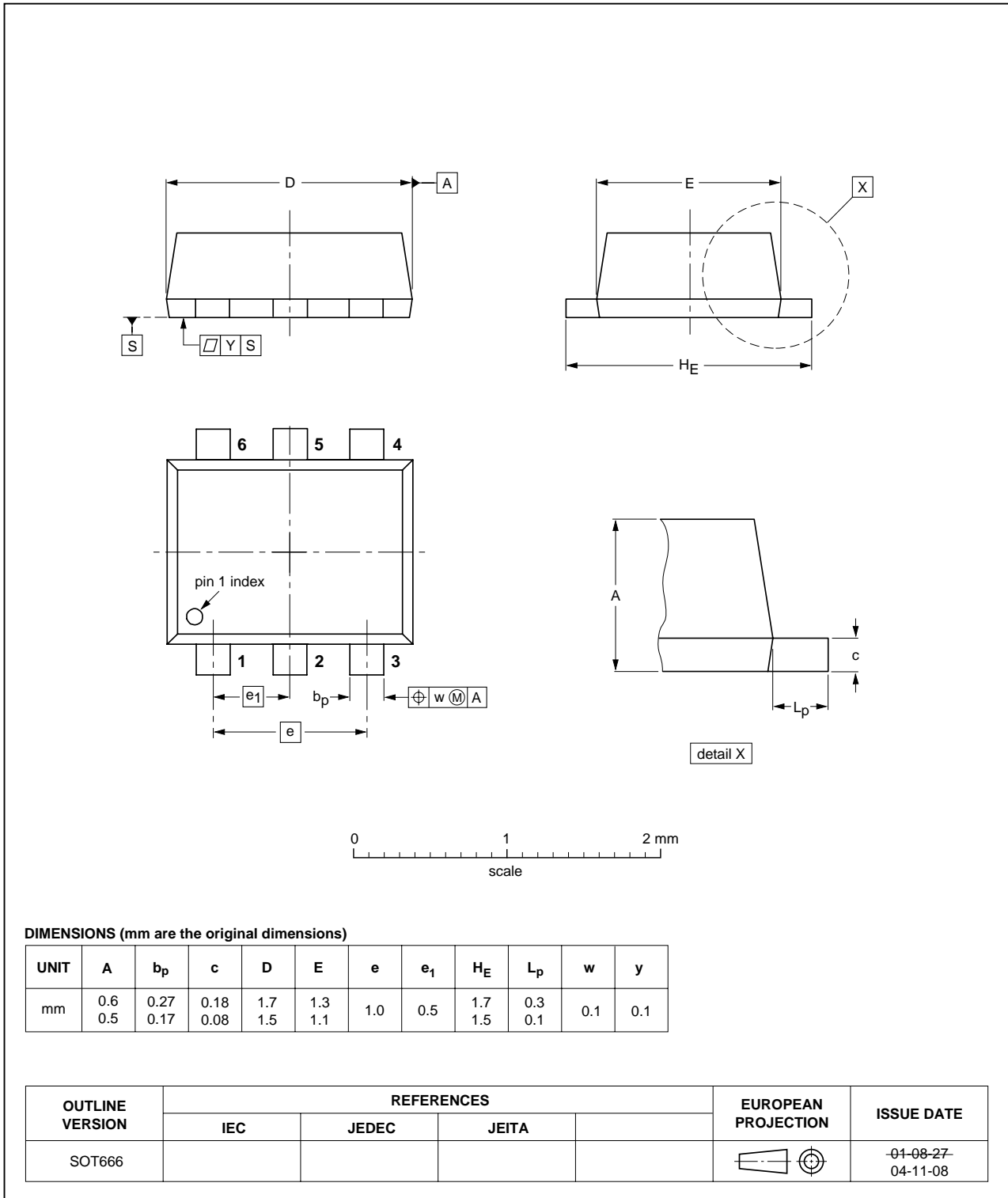

Fig 10. Package outline SOT666

9. Packing information

Table 9: Packing methods

The indicated -xxx are the last three digits of the 12NC ordering code. [\[1\]](#)

Type number	Package	Description	Packing quantity		
			3000	4000	10000
PEMD17	SOT666	4 mm pitch, 8 mm tape and reel	-	-115	-
PUMD17	SOT363	4 mm pitch, 8 mm tape and reel; T1 [2]	-115	-	-135
PUMD17	SOT363	4 mm pitch, 8 mm tape and reel; T2 [3]	-125	-	-165

[1] For further information and the availability of packing methods, see [Section 14](#).

[2] T1: normal taping

[3] T2: reverse taping

10. Revision history

Table 10: Revision history

Document ID	Release date	Data sheet status	Change notice	Doc. number	Supersedes
PEMD17_PUMD17_3	20050124	Product data sheet	-	9397 750 14367	PUMD17_2
Modifications:					
<ul style="list-style-type: none"> • This data sheet is an enhancement of data sheet PUMD17_2. • The format of this data sheet has been redesigned to comply with the new presentation and information standard of Philips Semiconductors. • Type PEMD17 added • Table 8 Characteristics: $V_{i(on)}$ input-on voltage and $V_{i(off)}$ input-off voltage renamed to $V_{I(on)}$ on-state input voltage and $V_{I(off)}$ off-state input voltage • Figure 1, 2, 3, 4, 5, 6, 7 and 8 electrical graphs for TR1 (NPN) and TR2 (PNP) added • Table 9 Packing information added 					
PUMD17_2	20040422	Product specification	-	9397 750 13099	PUMD17_1
PUMD17_1	20031016	Product specification	-	9397 750 11866	-

11. Data sheet status

Level	Data sheet status ^[1]	Product status ^[2] ^[3]	Definition
I	Objective data	Development	This data sheet contains data from the objective specification for product development. Philips Semiconductors reserves the right to change the specification in any manner without notice.
II	Preliminary data	Qualification	This data sheet contains data from the preliminary specification. Supplementary data will be published at a later date. Philips Semiconductors reserves the right to change the specification without notice, in order to improve the design and supply the best possible product.
III	Product data	Production	This data sheet contains data from the product specification. Philips Semiconductors reserves the right to make changes at any time in order to improve the design, manufacturing and supply. Relevant changes will be communicated via a Customer Product/Process Change Notification (CPCN).

[1] Please consult the most recently issued data sheet before initiating or completing a design.

[2] The product status of the device(s) described in this data sheet may have changed since this data sheet was published. The latest information is available on the Internet at URL <http://www.semiconductors.philips.com>.

[3] For data sheets describing multiple type numbers, the highest-level product status determines the data sheet status.

12. Definitions

Short-form specification — The data in a short-form specification is extracted from a full data sheet with the same type number and title. For detailed information see the relevant data sheet or data handbook.

Limiting values definition — Limiting values given are in accordance with the Absolute Maximum Rating System (IEC 60134). Stress above one or more of the limiting values may cause permanent damage to the device. These are stress ratings only and operation of the device at these or at any other conditions above those given in the Characteristics sections of the specification is not implied. Exposure to limiting values for extended periods may affect device reliability.

Application information — Applications that are described herein for any of these products are for illustrative purposes only. Philips Semiconductors make no representation or warranty that such applications will be suitable for the specified use without further testing or modification.

13. Disclaimers

Life support — These products are not designed for use in life support appliances, devices, or systems where malfunction of these products can reasonably be expected to result in personal injury. Philips Semiconductors customers using or selling these products for use in such applications do so at their own risk and agree to fully indemnify Philips Semiconductors for any damages resulting from such application.

Right to make changes — Philips Semiconductors reserves the right to make changes in the products - including circuits, standard cells, and/or software - described or contained herein in order to improve design and/or performance. When the product is in full production (status 'Production'), relevant changes will be communicated via a Customer Product/Process Change Notification (CPCN). Philips Semiconductors assumes no responsibility or liability for the use of any of these products, conveys no license or title under any patent, copyright, or mask work right to these products, and makes no representations or warranties that these products are free from patent, copyright, or mask work right infringement, unless otherwise specified.

14. Contact information

For additional information, please visit: <http://www.semiconductors.philips.com>

For sales office addresses, send an email to: sales.addresses@www.semiconductors.philips.com

15. Contents

1	Product profile	1
1.1	General description	1
1.2	Features	1
1.3	Applications	1
1.4	Quick reference data	1
2	Pinning information	2
3	Ordering information	2
4	Marking	2
5	Limiting values	3
6	Thermal characteristics	4
7	Characteristics	4
8	Package outline	7
9	Packing information	9
10	Revision history	10
11	Data sheet status	11
12	Definitions	11
13	Disclaimers	11
14	Contact information	11



© Koninklijke Philips Electronics N.V. 2005

All rights are reserved. Reproduction in whole or in part is prohibited without the prior written consent of the copyright owner. The information presented in this document does not form part of any quotation or contract, is believed to be accurate and reliable and may be changed without notice. No liability will be accepted by the publisher for any consequence of its use. Publication thereof does not convey nor imply any license under patent- or other industrial or intellectual property rights.

Date of release: 24 January 2005
Document number: 9397 750 14367

Published in The Netherlands