

PRODUCT NUMBER	DOUBLE - DECK HEADER (A)	LOWER EJECT MECHANISM (B)	UPPER EJECT MECHANISM (C)
71757-200CALF	71257-0000LF	72336-000CA	72336-000CA
71757-300CALF	71257-0000LF	72336-100CA	72336-100CA
71757-200CA	71257-0000	72336-000CA	72336-000CA
71757-300CA	71257-0000	72336-100CA	72336-100CA

mat'l. code		surface	tolerance	projection	product family
l t r e c n n o d r		ISO1302	ISO406 ISO1101	⊕	PCMCIA
date		tolerances unless other		MM	R/A CARDBUS DOUBLE DECK ASSEMBLY
J	ELX-N-007946	ZK	11/01/11	0.X±0.3	
k	ELX-N-011406	ZK	04/07/12	0.XX±0.13	
D	V70389	RHG	03/25/97	0°±2'	scale 3/4
E	V71446	RHG	10/07/97	dr	D.SHEAFFER 08/31/95
F	V81800	CGC	10/20/98	engr	D.BRANN 08/31/95
G	V12164	TFG	08/16/01	chr	D.BRANN 08/31/95
H	N05-0054	WB	03/01/05	appd	D.BRANN 08/31/95
sheet index	revision	K	K	K	
	sheet	1	2	3	

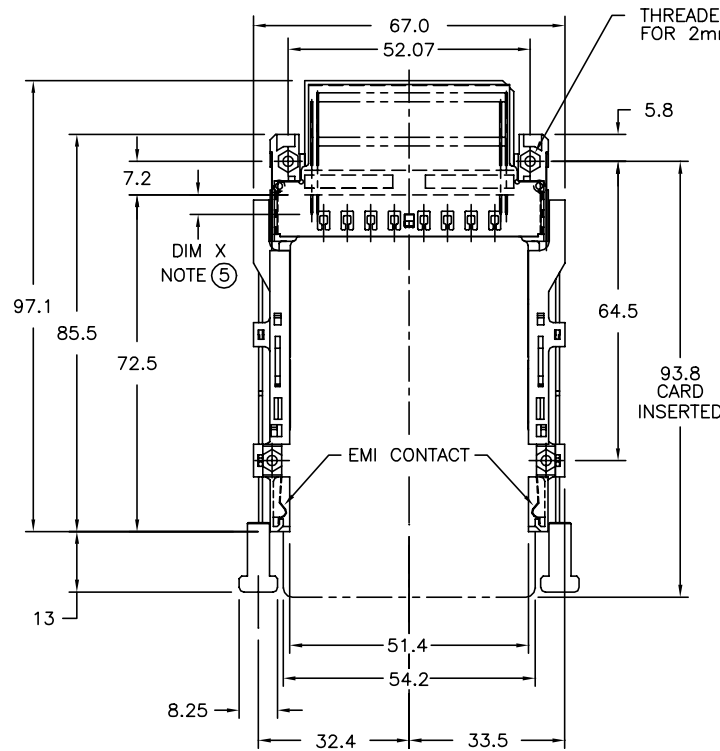

dwg no 71757 sheet 1 of 3 size A4  
type Product Customer Drawing



THREADED INSERT (2X)  
FOR 2mm SCREWS

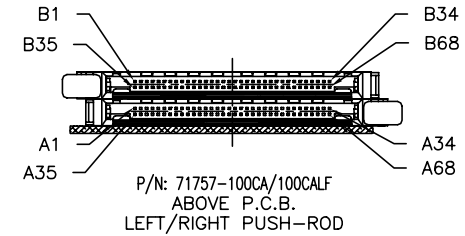
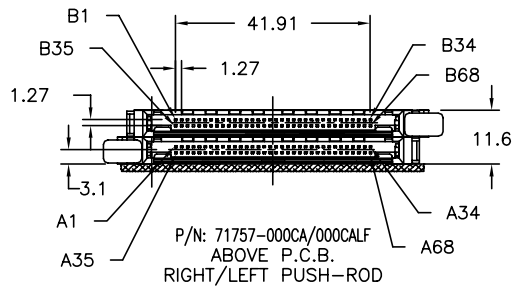
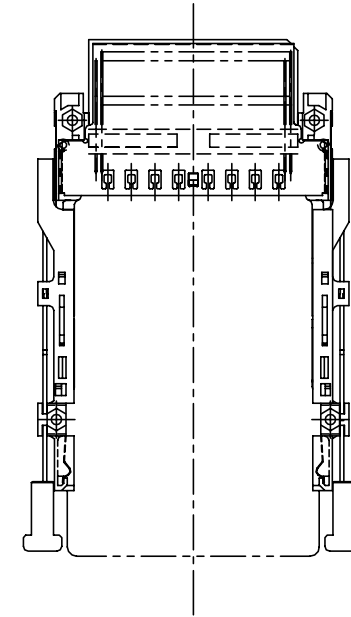
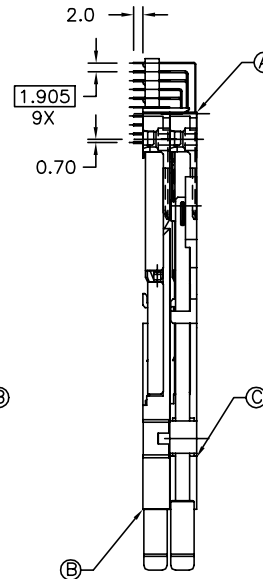
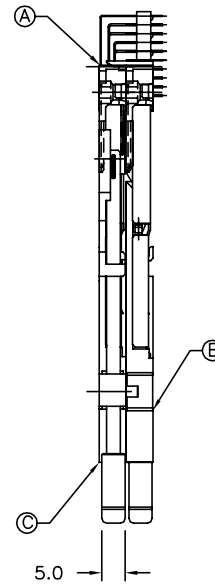

PRODUCT NUMBER	DOUBLE - DECK HEADER (A)	LOWER EJECT MECHANISM (B)	UPPER EJECT MECHANISM (C)
71757-000CALF	71257-0000LF	72336-100CA	72336-000CA
71757-100CALF	71257-0000LF	72336-000CA	72336-100CA
71757-000CA	71257-0000	72336-100CA	72336-000CA
71757-100CA	71257-0000	72336-000CA	72336-100CA

mat'l. code	surface ISO1302	tolerance ISO406 ISO1101	projection MM	product family PCMCIA
l. tecn no. dr	date	tolerances unless otherwise specified	title	
K		0.X±0.3	← MM →	R/A CARDBUS DOUBLE DECK ASSEMBLY
		0.XX±0.13	scale 3/4	
		0.XXX±0.05		
	dr	D.SHEAFFER 08/31/95		dwg no
	enr	D.BRANN 08/31/95		sheet 2 of 3
	chr	D.BRANN 08/31/95		size
	app	D.BRANN 08/31/95		A4
sheet index	revision sheet			type Product Customer Drawing

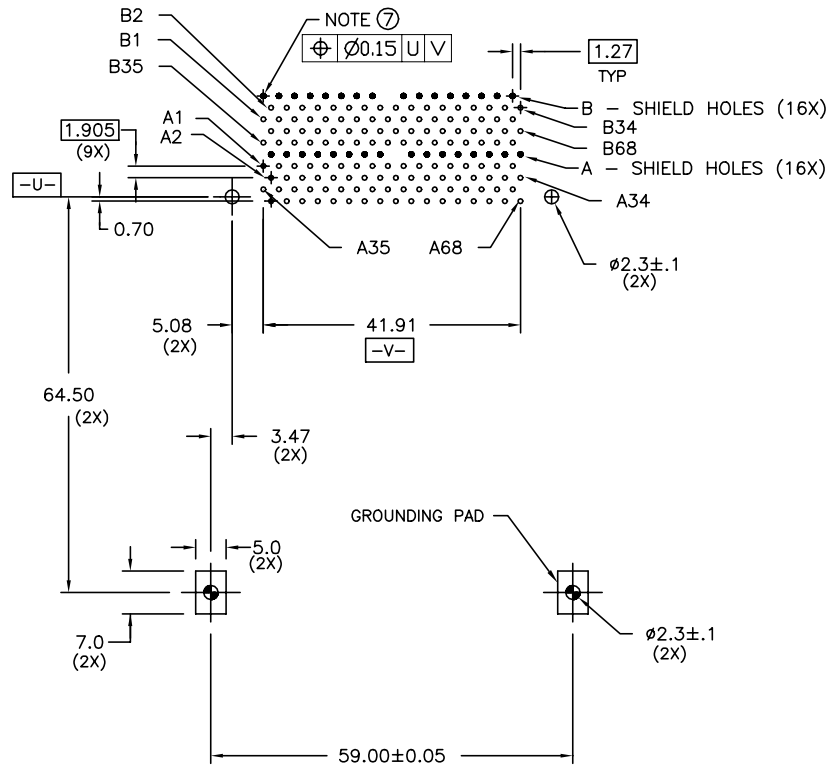

NOTES:

- 1 8mm MIN CARD EJECT.
- 2 EJECT TRAVEL: 9.5mm
- 3 MATERIAL:
  - 3.1 HEADER ASSY:  
HOUSING: HIGH TEMPERATURE THERMOPLASTIC UL94V-0 BLACK  
PIN: COPPER ALLOY
  - 3.2 EJECT MECHANISM ASSY:  
HOUSING: HIGH TEMPERATURE THERMOPLASTIC UL94V-0 BLACK  
COVER PLATE, EJECT PLATE, LINK ARM,  
PUSH ROD: STAINLESS STEEL  
EMI CONTACT: PHOSPHOR BRONZE
- 4 FINISH (PIN)  
UNDER PLATING: 0.5um Ni  
CONTACT AREA: 0.076 μm MIN. GOLD

SOLDER TAIL(TIN LEAD OPTION): 2.5um Sn-Pb  
SOLDER TAIL(LEAD FREE OPTION): 2.5um PURE TIN

⑤	DIM "X"	4.25±0.1	3.5±0.1	5.0±0.1
	PIN NUMBER	OTHERS	36,67	1,17,34,35,51,68

- 6 RECOMMENDED SCREW TORQUE: 1.0 TO 1.5 MAX in-lbs. (1.2-1.7 cm-kgs).  
RECOMMENDED HOLD DOWN: 2mm SCREWS AND NUTS  
SEE 95121 AND 92869 FOR INFORMATION.
- 7 RECOMMENDED DIAMETER IS Ø1.0. FOR PROCESSES USING PASTE REFLOW, HOLE MAY BE AS SMALL AS Ø0.79.
- 8 IF LEAD FREE P/N.THE HOUSING WILL WITHSTAND EXPOSURE TO 260°C PEAK TEMPERATURE FOR 10 SECONDS IN A WAVE SOLDER APPLICATION WITH A 1.00MM MINIMUM THICK CIRCUIT BOARD.
- 9 IF LEAD FREE P/N.THE PRODUCT MEETS EUROPEAN UNION DIRECTIVES AND OTHER COUNTRY REGULATIONS AS DISCRIBLED IN GS-22-008
- 10 LEAD FREE P/N PACKAGING MEETS GS-14-920 SPECIFICATION
- 11 PRODUCT SPEC: 110-263

mat'l. code	surface ISO1302	tolerance ISO406 ISO1101	projection MM	product family PCMCIA
ltr ecn nodr date	tolerances unless otherwise specified			title
K	angle	0.X±0.3	MM	R/A CARDBUS DOUBLE DECK ASSEMBLY
	σ±2°	0.XX±0.13	scale 3/4	
	dr	D.SHEAFFER 08/31/95	FCI	dwg no
	enr	D.BRANN 08/31/95		sheet 3 of 3
	chr	D.BRANN 08/31/95		71757
	app	D.BRANN 08/31/95		size A4
sheet index	revision sheet			type Product Customer Drawing