

300 mA ultra low-noise LDO with Power Good and soft-start



TSOT23-5L

Features

- Ultra-low output noise: 7.5 μV_{RMS}
- Operating input voltage range: 1.6 V to 5.5 V
- Undervoltage lockout
- Output current up to 300 mA
- Very low quiescent current: 16 μA at no-load
- Controlled I_q in dropout condition
- Very low dropout voltage: 100 mV at 200 mA, 150 mV at 300 mA
- Very high PSRR: 80 dB @ 100 Hz, 60 dB @ 100 kHz
- Output voltage accuracy: 2% across line, load and temperature
- Output voltage versions: from 1 V to 5 V, with 50 mV step
- Logic-controlled electronic shutdown
- Power Good
- Output discharge feature
- Internal soft-start to limit the in-rush current
- Overcurrent and thermal protections
- Temperature range: from -40 °C to +125 °C
- Package: TSOT23-5L

Applications

- Smartphones/tablets
- Image sensors
- Instrumentation
- VCO and RF modules
- HDD and SSD
- Portable and other battery powered devices

Description

The **LDLN030** is a 300 mA very low-dropout voltage regulator, able to work with an input voltage ranging from 1.6 V to 5.5 V.

The typical dropout voltage at 300 mA load is 150 mV.

The very low quiescent current, which is just 16 μA at no load, extends battery-life of applications requiring very long standby time.

Thanks to its ultra low-noise value and high PSRR the device provides a very clean output, suitable for ultra-sensitive loads. It is stable with ceramic capacitors.

The enable logic control function puts the **LDLN030** into shutdown mode allowing a total current consumption lower than 1 μA .

The device also includes short-circuit constant current limiting, undervoltage lockout, soft-start, Power Good and thermal protection.

Typical applications are noise sensitive loads such as ADC, VCO in mobile phones and tablets, wireless lan devices. The **LDLN030** is designed to keep the quiescent

Maturity status link	
LDLN030	
Device summary	
Order code	LDLN030G33R
Package	TSOT23-5L
Output voltage	3.3 V
Marking	KN33
Packing	Tape and reel

current under control and at a low value also during dropout operation, helping to extend even more the operating time of battery-powered devices.

1 Diagram

Figure 2. Block diagram

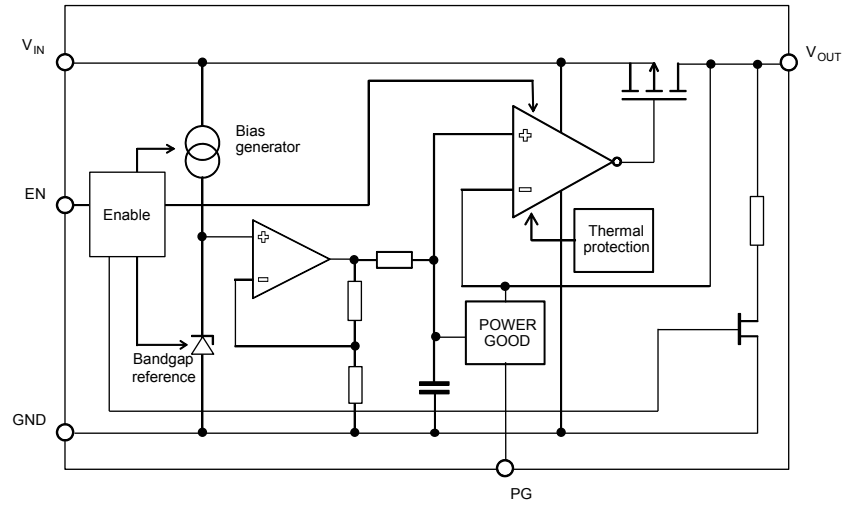

2 Pin configuration

Figure 3. Pin connection (top view)

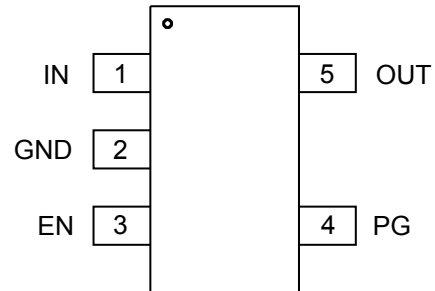
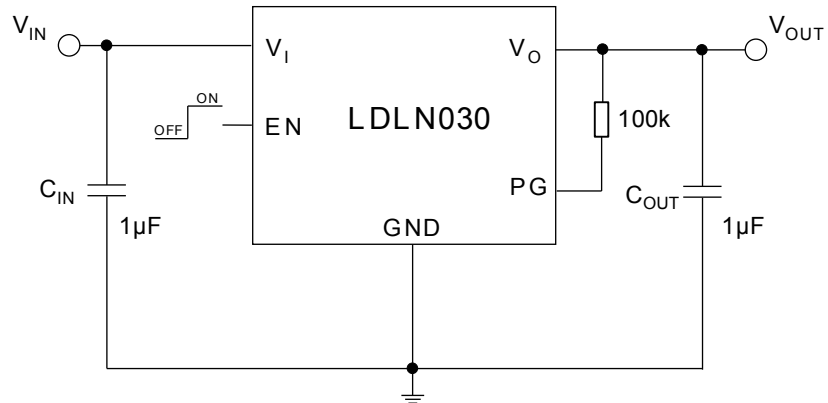

Table 1. Pin description

Symbol	TSOT23-5L	Description
V _{IN}	1	LDO supply voltage
V _{OUT}	5	LDO output voltage
GND	2	Ground
EN	3	Enable input: set V _{EN} = high to turn on the device; V _{EN} = low to turn off the device. Do not left floating.
PG	4	Power Good

3 Typical application diagram

Figure 4. Application diagram



4 Maximum ratings

Table 2. Absolute maximum ratings

Symbol	Parameter	Value	Unit
V_{IN}	Input supply voltage	-0.3 to 7	V
V_{OUT}	Output voltage	-0.3 to $V_{IN} + 0.3$	V
I_{OUT}	Output current	Internally limited	A
EN	Enable pin voltage	-0.3 to $V_{IN} + 0.3$	V
P_D	Power dissipation	Internally limited	W
ESD	Charge device model	± 1000	V
	Human body model	± 2000	
T_{J-OP}	Operating junction temperature	- 40 to 125	°C
T_{J-MAX}	Maximum junction temperature	150	°C
T_{STG}	Storage temperature	- 55 to 150	°C

Table 3. Thermal data

Symbol	Parameter	Value	Unit
R_{thJA}	Thermal resistance junction-ambient	202	°C/W

5 Electrical characteristics

- 40 °C < T_J < 125 °C , typical values refer to T_J = 25 °C, V_{IN} = V_{OUT (nom)} + 1 V or 1.6 V, whichever is greater; V_{EN} = 1.2 V; C_{IN} = 1 μF; C_{OUT} = 1 μF; I_{OUT} = 1 mA.

Table 4. Electrical characteristics

Symbol	Parameter	Test conditions	Min.	Typ.	Max.	Unit
V _{IN}	Operating input voltage range	T _J = 25 °C	1.6		5.5	V
V _{UVLO}	Undervoltage lockout	V _{IN} rising	1.3	1.4	1.5	V
V _{OUT}	Output voltage accuracy ⁽¹⁾	V _{OUT} + 1 V < V _{IN} < 5.5 V, 1 mA < I _{OUT} < 0.25 A, V _{OUT} ≥ 1.8 V	-2.0		+2.0	%
		V _{OUT} + 1 V < V _{IN} < 5.5 V, 1 mA < I _{OUT} < 0.25 A, V _{OUT} < 1.8 V	-3.0		+3.0	
ΔV _{OUT} / ΔV _{IN}	Static line regulation ⁽¹⁾	V _{OUT} + 0.3 V < V _{IN} < 5.5 V;		300	1500	μV/V
	Line transient ⁽²⁾	ΔV _{IN} = +/- 0.6 V, t _{rise} = t _{fall} = 30 μs		+/-1		mV
ΔV _{OUT} /ΔI _{OUT}	Static load regulation	0 mA < I _{OUT} < 0.2 A;		50	240	μV/mA
		1 mA < I _{OUT} < 0.3 A		0.002	0.007	%/mA
	Load transient ⁽²⁾	I _{OUT} = 1 mA to 200 mA and back t _{rise} = t _{fall} = 1 μs		+/-90		mV
V _{DROP}	Dropout voltage ⁽³⁾	I _{OUT} = 0.1 A; V _{OUT} = 3.3 V		50		mV
		I _{OUT} = 0.2A; V _{OUT} = 3.3 V		100	180	
		I _{OUT} = 0.3 A; V _{OUT} = 3.3 V		150	230	
eN	Output noise voltage ⁽²⁾	f = 10 Hz to 100 kHz; I _{OUT} = 1 mA		10		μV _{RMS}
		f = 10 Hz to 100 kHz; I _{OUT} = 0.2 A		7.5	20	
		f = 10 Hz to 100 kHz; I _{OUT} = 0.3 A		7.5		
SVR	Supply voltage rejection ⁽²⁾	f = 100 Hz; I _{OUT} = 20 mA		80		dB
		f = 1 kHz ; I _{OUT} = 20 mA		80		
		f = 10 kHz ; I _{OUT} = 20 mA		75		
		f = 100 kHz ; I _{OUT} = 20 mA		60		
		f = 100 Hz; I _{OUT} = 150 mA		70		
		f = 1 kHz ; I _{OUT} = 150 mA		68		
		f = 10 kHz ; I _{OUT} = 150 mA		53		
I _Q	Quiescent current	I _{OUT} = 0 A, including enable current		16	30	μA
		I _{OUT} = 0.2 A		200	350	
		I _{OUT} = 0.3 A		240	360	
	Shutdown current	V _{EN} = 0 V		0.2	1	μA
I _{SC}	Short-circuit current	V _{OUT} = 0 V	300	500		mA
R _{LOW}	Output discharge resistance	V _{EN} = 0 V, de-assert V _{EN} from V _{EN_HI} to V _{EN_LO}		300	500	Ω
V _{EN}	V _{IL} , enable input logic low	V _{OUT} + 1 V ⁽¹⁾ < V _{IN} < 5.5 V			0.4	V
	V _{IH} , enable input logic high		1.2			

Symbol	Parameter	Test conditions	Min.	Typ.	Max.	Unit
I _{EN}	Enable pin input current	V _{IN} = V _{EN} = 5.5 V (pull-down)		5		μA
t _{ON1}	Rise time (SS) ⁽²⁾	I _{OUT} = 0 mA to 200 mA for V _{OUT} = 10% V _{OUT(nom)} to 95% V _{OUT(nom)}		200		μs
t _{ON2}	Turn-on time ⁽²⁾	I _{OUT} = 0 mA to 200 mA, from V _{EN} assertion to 95% of V _{OUT(nom)}		450	550	μs
T _{SHDN}	Thermal shutdown ⁽²⁾	I _{OUT} > 1 mA	130	160	200	°C
	Hysteresis ⁽²⁾			20		
V _{PG-}	Power Good threshold voltage	V _{OUT} decreasing	90	92	94	%V _{OUT}
V _{PG+}		V _{OUT} increasing	92	94	96	
PG _{HYS}	Power Good hysteresis	Measured at V _{OUT}		2		%V _{OUT}
PG _L	Power Good output low	De-assert V _{EN} from V _{EN_HI} to V _{EN_LO}		0.1	0.4	V
PG _{IL}	Power Good pin leakage current ⁽²⁾	Measured at V _{OUT}		0.002	1	μA
PG _{RT}	Power Good reaction time ⁽²⁾			2	10	μs
PG _{RD}	Power Good delay ⁽²⁾			2	10	μs

1. V_{IN} = V_{OUT} + 1 V or 1.6 V, whichever is greater. Not applicable for 5 V output voltage versions.

2. Performance guaranteed by design and/or characterization, and not production tested.

3. Dropout voltage is the input-to-output voltage difference at which the output voltage is 100 mV below its nominal value.

Note:

Performance guaranteed over the indicated operating temperature range by design and/or characterization, and/or production tested at T_J = T_A = 25 °C. Low duty cycle pulse techniques are used during testing to maintain the junction temperature as close to ambient as possible.

Table 5. Recommended input and output capacitors

Symbol	Parameter	Test conditions	Min.	Typ.	Max.	Unit
C _{IN}	Input capacitance	Stability	0.7	1		μF
C _{OUT}	Output capacitance		0.7	1	10	
ESR	Output/input capacitance		5		500	mΩ

6 Typical characteristics

The following plots are referred to LDLN030 in the typical application circuit and, unless otherwise noted, at $T_A = 25^\circ\text{C}$.

Figure 5. Output voltage vs. temperature ($V_{IN} = 4.3\text{ V}$, $I_{OUT} = 1\text{ mA}$)

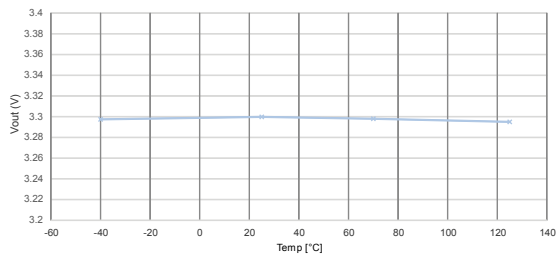

Figure 6. Output voltage vs. temperature ($V_{IN} = 4.3\text{ V}$, $I_{OUT} = 300\text{ mA}$)

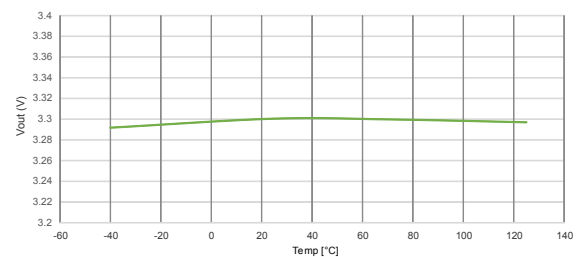

Figure 7. Load regulation vs. temperature ($V_{IN} = 4.3\text{ V}$, I_{OUT} from 1 mA to 300 mA)

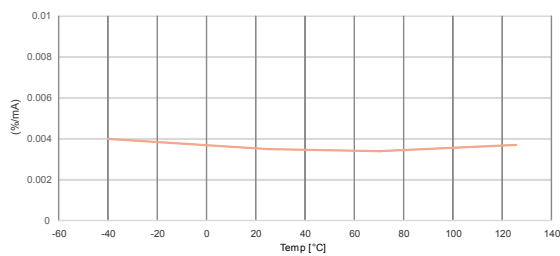

Figure 8. Line regulation vs. temperature (V_{IN} from 4.3 V to 5.5 V, $I_{OUT} = 1\text{ mA}$)

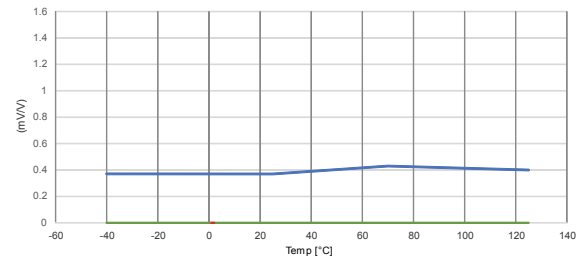

Figure 9. Quiescent current vs. temperature, ($I_{OUT} = 0\text{ mA}$)

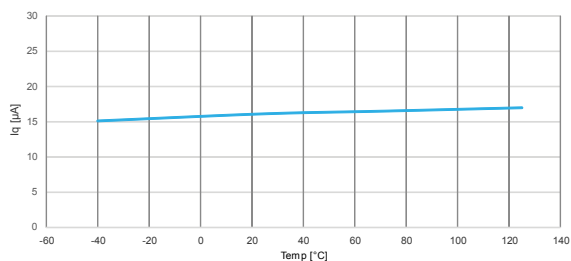

Figure 10. Quiescent current vs. temperature, ($I_{OUT} = 200\text{ mA}$)

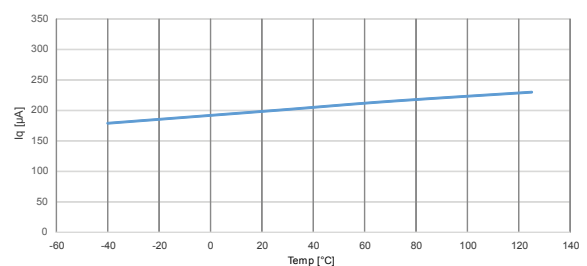

Figure 11. UVLO vs. temperature

Figure 12. PG threshold vs. temperature

Figure 13. Power Good transient

Figure 14. Power Good transient

Figure 15. Dropout voltage vs. temperature $I_{OUT} = 100\text{ mA}$

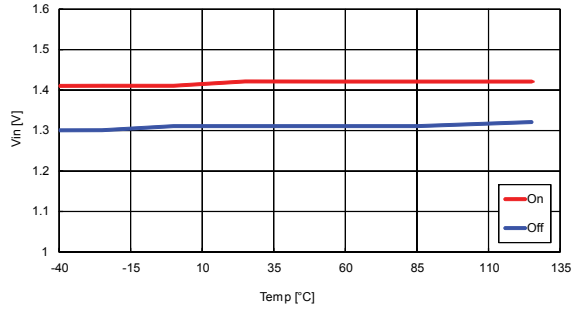
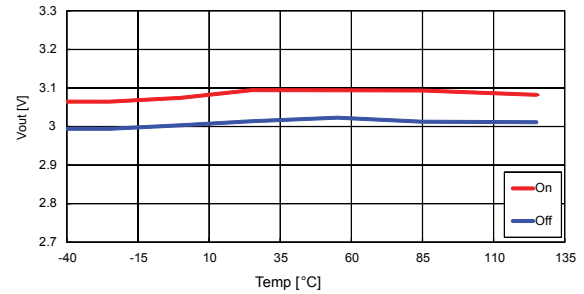
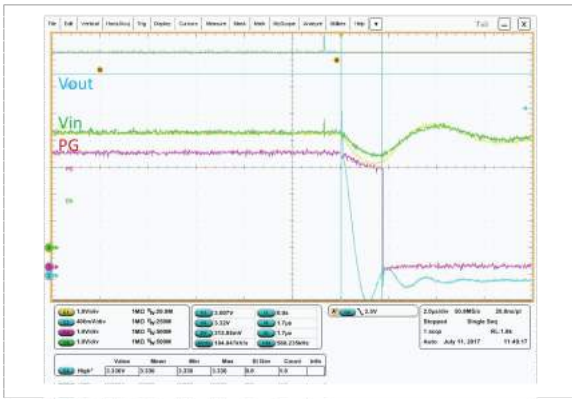
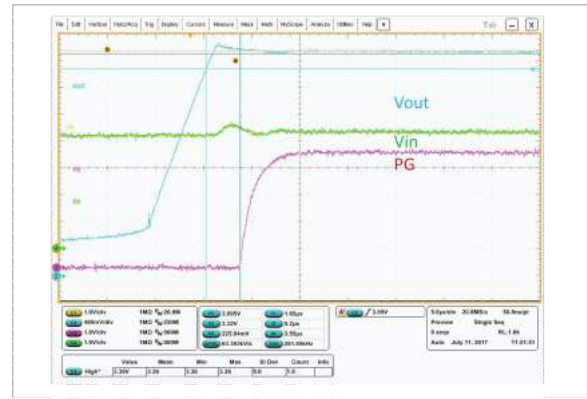
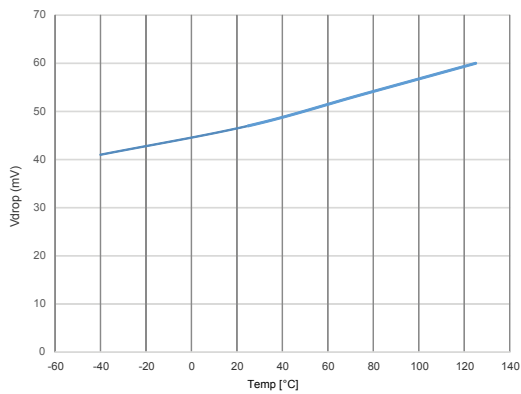
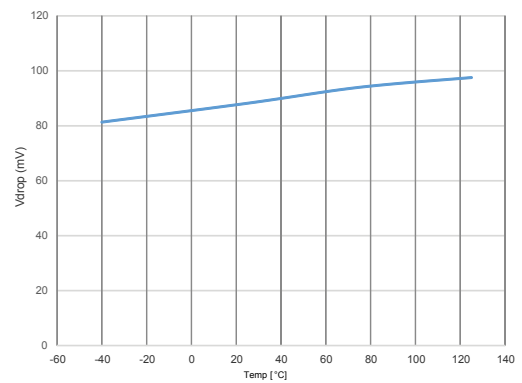
Figure 16. Dropout voltage vs. temperature $I_{OUT} = 200\text{ mA}$

Figure 17. Output voltage vs. input voltage

Figure 18. Short-circuit current vs. temperature

Figure 19. $R_{\text{discharge}}$ vs. temperature

Figure 20. Stability region vs. C_{OUT} and ESR

Figure 21. PSRR vs. frequency

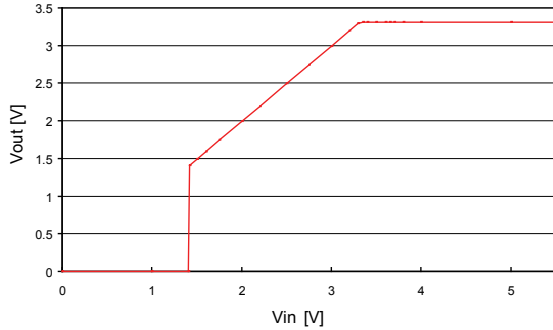
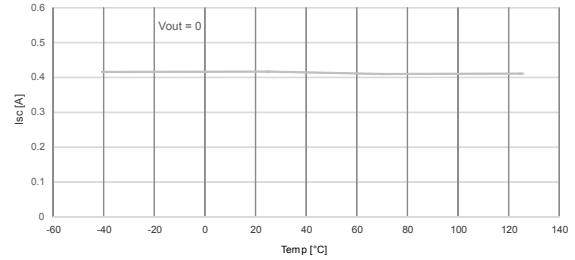
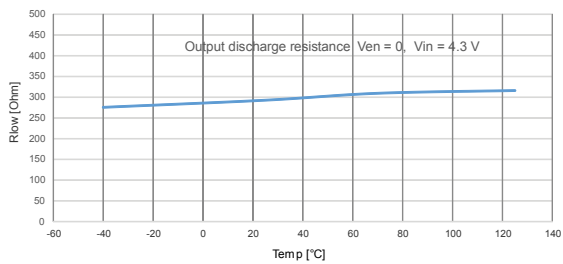
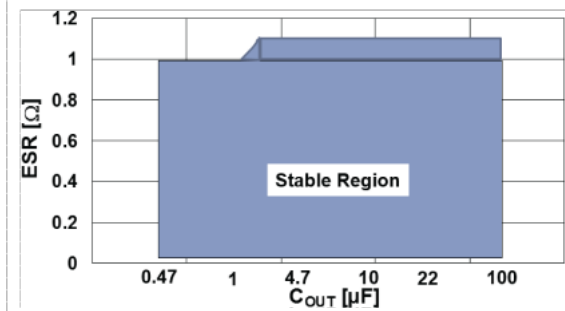
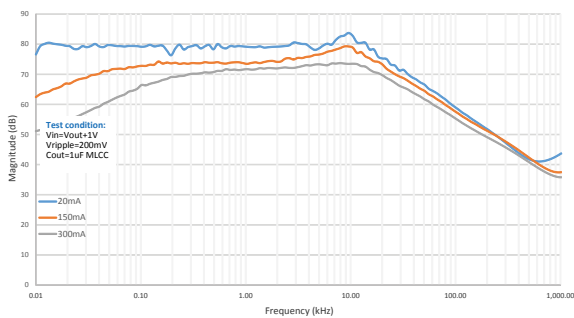
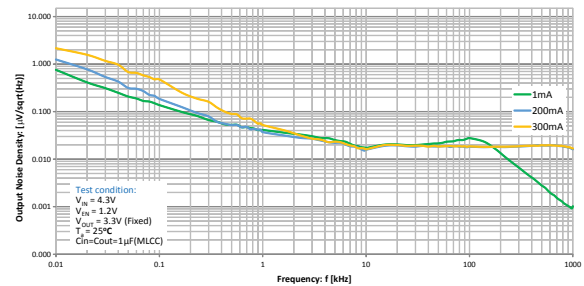
Figure 22. Noise density vs. frequency

Figure 23. Line transient

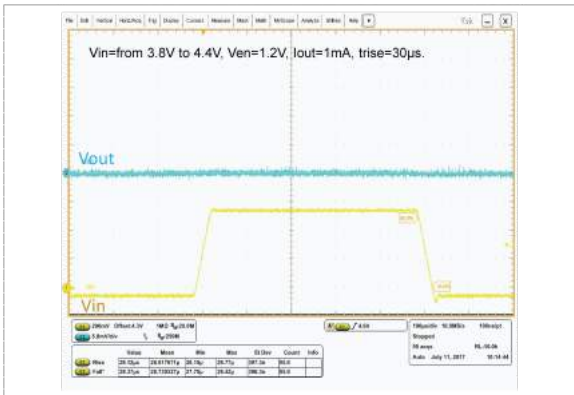

Figure 24. Load transient

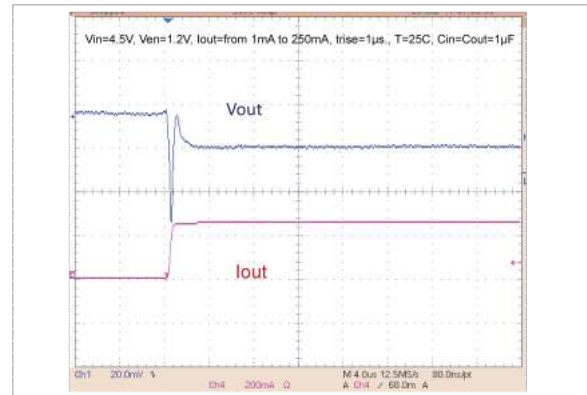

Figure 25. Load transient

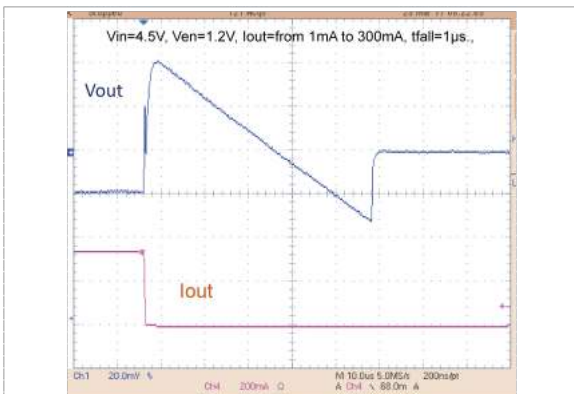

Figure 26. Inrush current

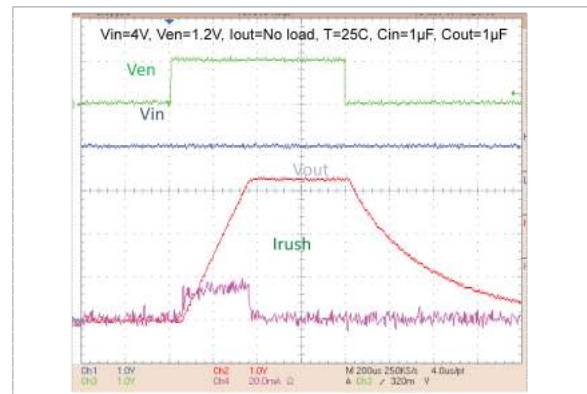

Figure 27. Enable transient

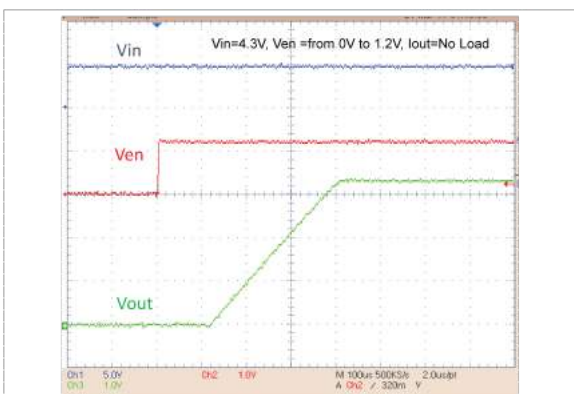
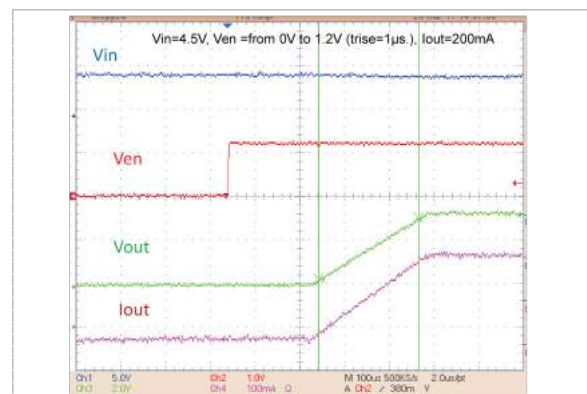

Figure 28. Enable transient



7 Package information

In order to meet environmental requirements, ST offers these devices in different grades of ECOPACK® packages, depending on their level of environmental compliance. ECOPACK® specifications, grade definitions and product status are available at: www.st.com. ECOPACK® is an ST trademark.

7.1 TSOT23-5L package information

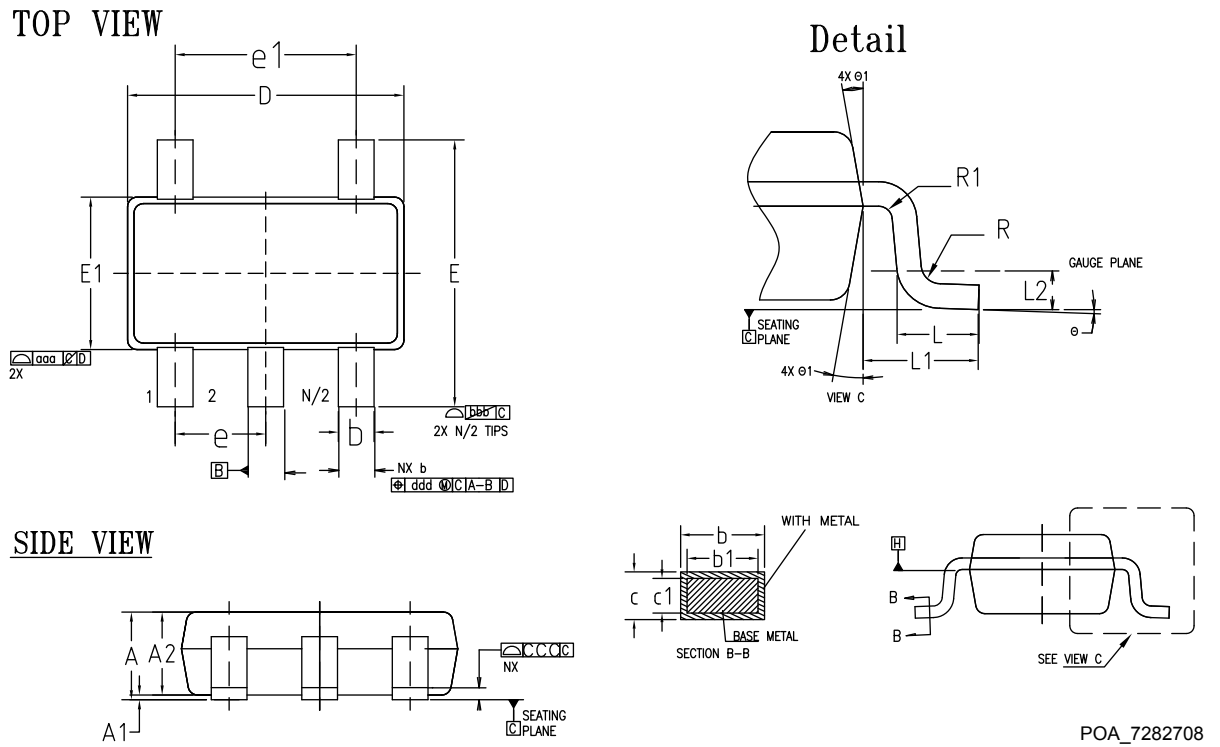
Figure 29. TSOT23-5L package outline

Table 6. TSOT23-5L mechanical data

Dim.	mm		
	Min.	Typ.	Max.
A			1.00
A1	0.01	0.05	0.10
A2	0.84	0.87	0.90
b	0.30		0.45
b1	0.31	0.35	0.39
e		0.95 BSC	
e1		1.90 BSC	
c	0.12	0.15	0.20
c1	0.08	0.13	0.16
D		2.90 BSC	
E		2.80 BSC	
E1		1.60 BSC	
L	0.30	0.40	0.50
L1		0.60 REF	
L2		0.25 BSC	

Dim.	mm		
	Min.	Typ.	Max.
R	0.10		
R1	0.10		0.25
e	0°	4°	8°
e1	4°	10°	12°
N		5	

Figure 30. TSOT23-5L tape and reel drawing

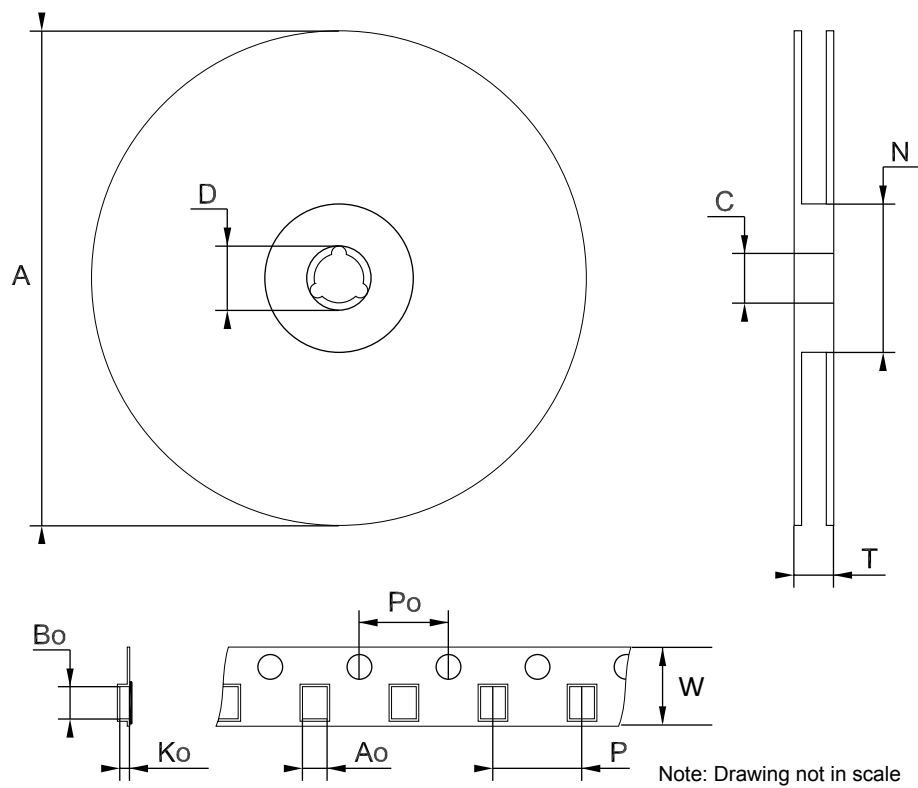
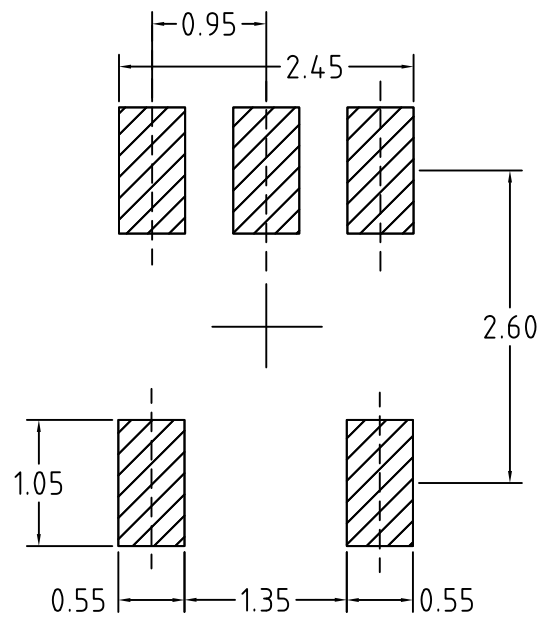

Table 7. TSOT23-5L tape and reel

Dim.	mm		
	Min.	Typ.	Max.
A			180
C	12.8	13.0	13.2
D	20.2		
N	60		
T			14.4
Ao	3.13	3.23	3.33
Bo	3.07	3.17	3.27
Ko	1.27	1.37	1.47

Dim.	mm		
	Min.	Typ.	Max.
Po	3.9	4.0	4.1
P	3.9	4.0	4.1
W		8.0	

Figure 31. TSOT23-5L footprint data (dimensions are in mm)



Revision history

Table 8. Document revision history

Date	Revision	Changes
08-Feb-2018	1	Initial release.

Contents

1	Diagram	3
2	Pin configuration	4
3	Typical application diagram	5
4	Maximum ratings	6
5	Electrical characteristics	7
6	Typical characteristics	9
7	Package information	13
	7.1 TSOT23-5L package information	14
	Revision history	17

List of tables

Table 1.	Pin description	4
Table 2.	Absolute maximum ratings	6
Table 3.	Thermal data	6
Table 4.	Electrical characteristics	7
Table 5.	Recommended input and output capacitors	8
Table 6.	TSOT23-5L mechanical data	14
Table 7.	TSOT23-5L tape and reel	15
Table 8.	Document revision history	17

List of figures

Figure 2.	Block diagram	3
Figure 3.	Pin connection (top view)	4
Figure 4.	Application diagram.	5
Figure 5.	Output voltage vs. temperature ($V_{IN} = 4.3\text{ V}$, $I_{OUT} = 1\text{ mA}$)	9
Figure 6.	Output voltage vs. temperature ($V_{IN} = 4.3\text{ V}$, $I_{OUT} = 300\text{ mA}$)	9
Figure 7.	Load regulation vs. temperature ($V_{IN} = 4.3\text{ V}$, I_{OUT} from 1 mA to 300 mA)	9
Figure 8.	Line regulation vs. temperature (V_{IN} from 4.3 V to 5.5 V, $I_{OUT} = 1\text{ mA}$)	9
Figure 9.	Quiescent current vs. temperature, ($I_{OUT} = 0\text{ mA}$)	9
Figure 10.	Quiescent current vs. temperature, ($I_{OUT} = 200\text{ mA}$)	9
Figure 11.	UVLO vs. temperature	10
Figure 12.	PG threshold vs. temperature	10
Figure 13.	Power Good transient	10
Figure 14.	Power Good transient	10
Figure 15.	Dropout voltage vs. temperature $I_{OUT} = 100\text{ mA}$	10
Figure 16.	Dropout voltage vs. temperature $I_{OUT} = 200\text{ mA}$	10
Figure 17.	Output voltage vs. input voltage	11
Figure 18.	Short-circuit current vs. temperature	11
Figure 19.	$R_{\text{discharge}}$ vs. temperature	11
Figure 20.	Stability region vs. C_{OUT} and ESR.	11
Figure 21.	PSRR vs. frequency	11
Figure 22.	Noise density vs. frequency	11
Figure 23.	Line transient	12
Figure 24.	Load transient	12
Figure 25.	Load transient	12
Figure 26.	Inrush current.	12
Figure 27.	Enable transient	12
Figure 28.	Enable transient	12
Figure 29.	TSOT23-5L package outline.	14
Figure 30.	TSOT23-5L tape and reel drawing	15
Figure 31.	TSOT23-5L footprint data (dimensions are in mm)	16

IMPORTANT NOTICE – PLEASE READ CAREFULLY

STMicroelectronics NV and its subsidiaries (“ST”) reserve the right to make changes, corrections, enhancements, modifications, and improvements to ST products and/or to this document at any time without notice. Purchasers should obtain the latest relevant information on ST products before placing orders. ST products are sold pursuant to ST’s terms and conditions of sale in place at the time of order acknowledgement.

Purchasers are solely responsible for the choice, selection, and use of ST products and ST assumes no liability for application assistance or the design of Purchasers’ products.

No license, express or implied, to any intellectual property right is granted by ST herein.

Resale of ST products with provisions different from the information set forth herein shall void any warranty granted by ST for such product.

ST and the ST logo are trademarks of ST. All other product or service names are the property of their respective owners.

Information in this document supersedes and replaces information previously supplied in any prior versions of this document.

© 2018 STMicroelectronics – All rights reserved