



Maswell Ultra Wideband Log Periodic Antenna

AN_Master_004 MIMO



Mechanical dimension

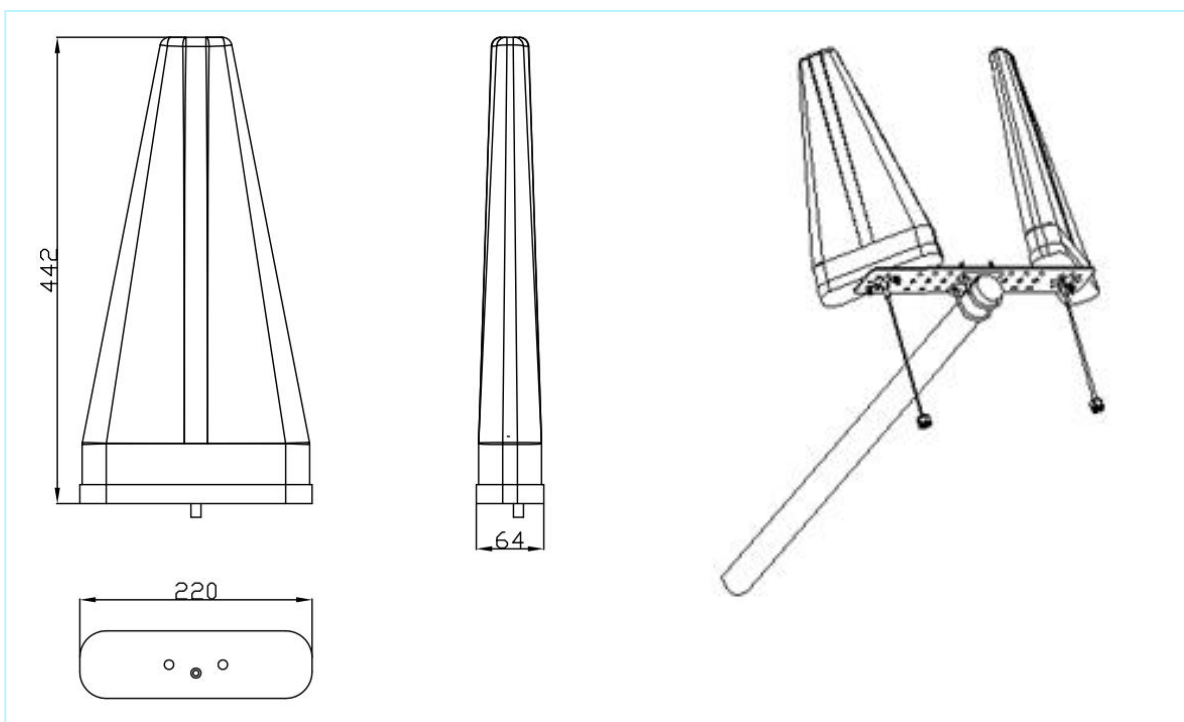



Maswell Ultra Wideband Log Periodic Antenna

AN_Master_004 MIMO

Specifications

Item	Specifications	
Antenna*2	Center Frequency	600~6000 MHz
	Polarization	Linear
	Gain	6.80dBi (Average)
	V.S.W.R	<2.0
	Impedance	50Ω
	Mounting Method	U bolt
	Cable	Ultra Low loss cable 4 meters (LMR 600 equivalent)
	Connector	Both SMA male and N male supported
	Dimension	442* 220*64mm
Installation Kit	U bolt Dimension	450*90*20mm
Environmental	Operating Temperature	-40°C~+85°C
	Vibration	10 to 55Hz with 1.5mm amplitude 2hours
	Environmentally Friendly	ROHS Compliant

Maswell Ultra Wideband Log Periodic Antenna

AN_Master_004 MIMO

Product Configuration in Details



The AN_Master_004 MIMO comes with two AN_Master_004 and an Installation Kit, and the AN_Master_004 comes with two boxes:

- ❖ **Box One: AN_Master_004 with 10cm cable and N male connector**
- ❖ **Box Two: One unit of Ultra low loss 0.6 inch cable (LMR 600 equivalent) with N female to N male connector
One Unit of Interface cable 10cm N female to SMA male**

No need to worry about the high cable loss above 5GHz!

Maswell Ultra Wideband Log Periodic Antenna

Simulation Results

S11

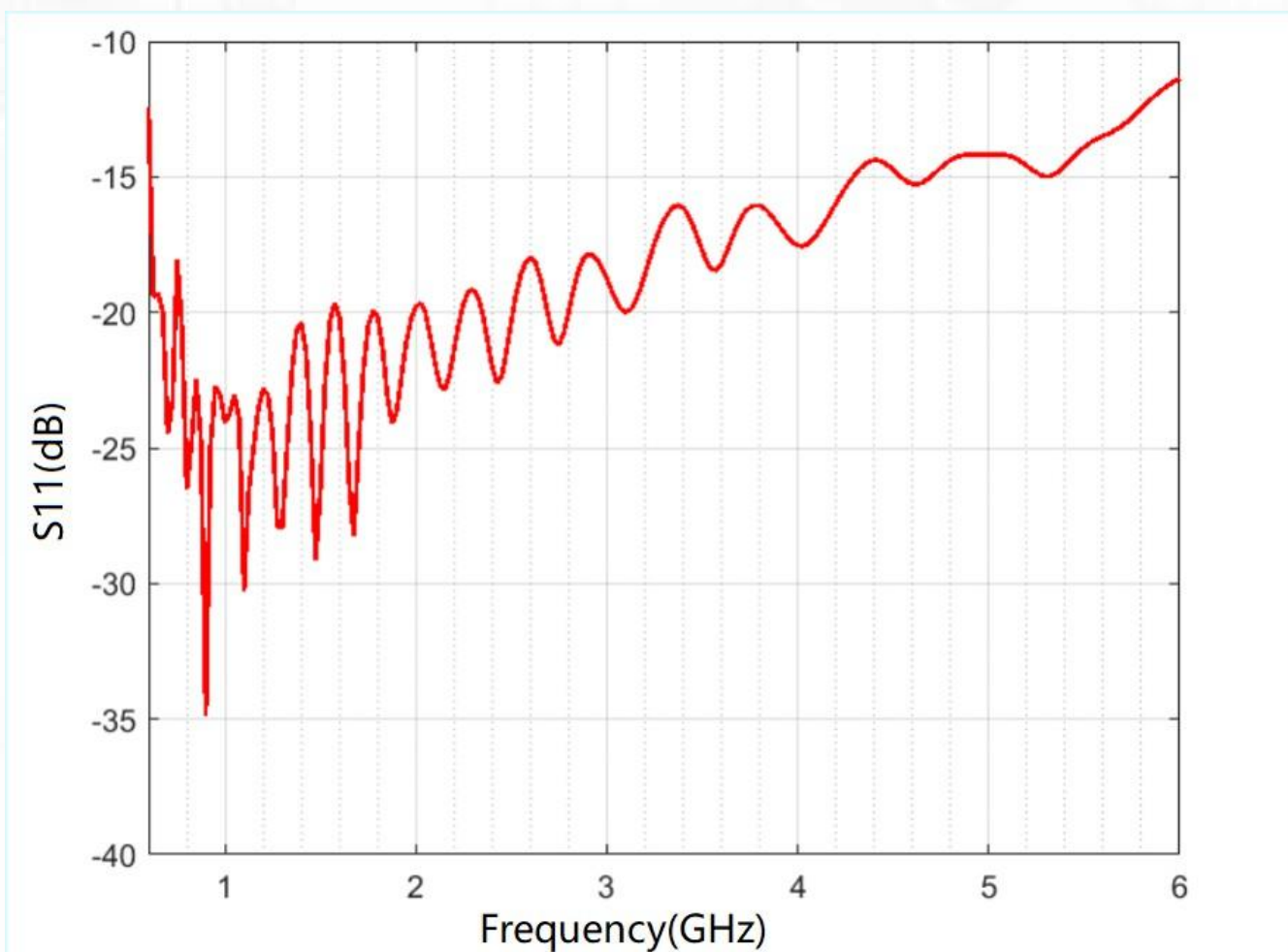

Maswell Ultra Wideband Log Periodic Antenna

Simulation Results

VSWR

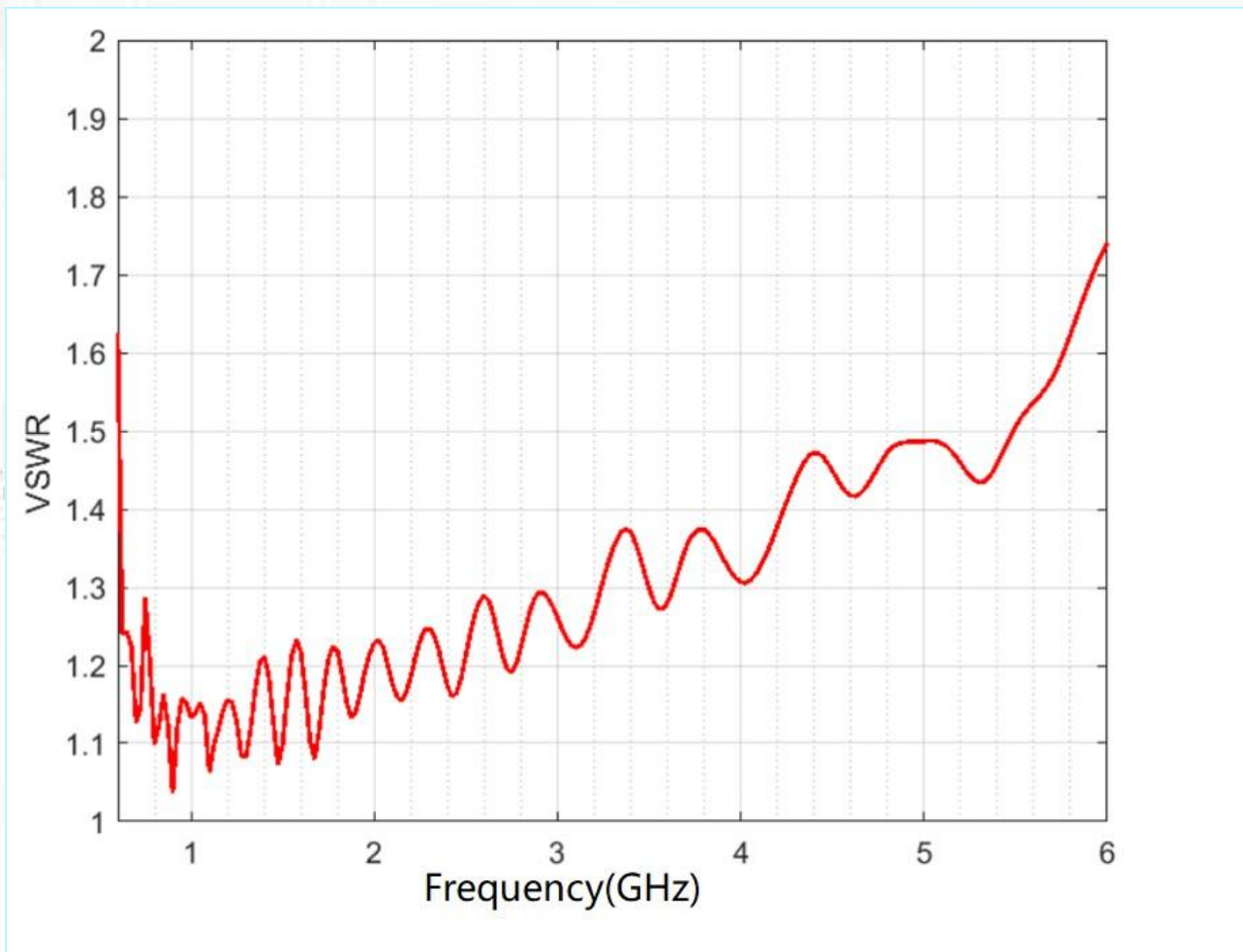

Maswell Ultra Wideband Log Periodic Antenna

Simulation Results

Gain

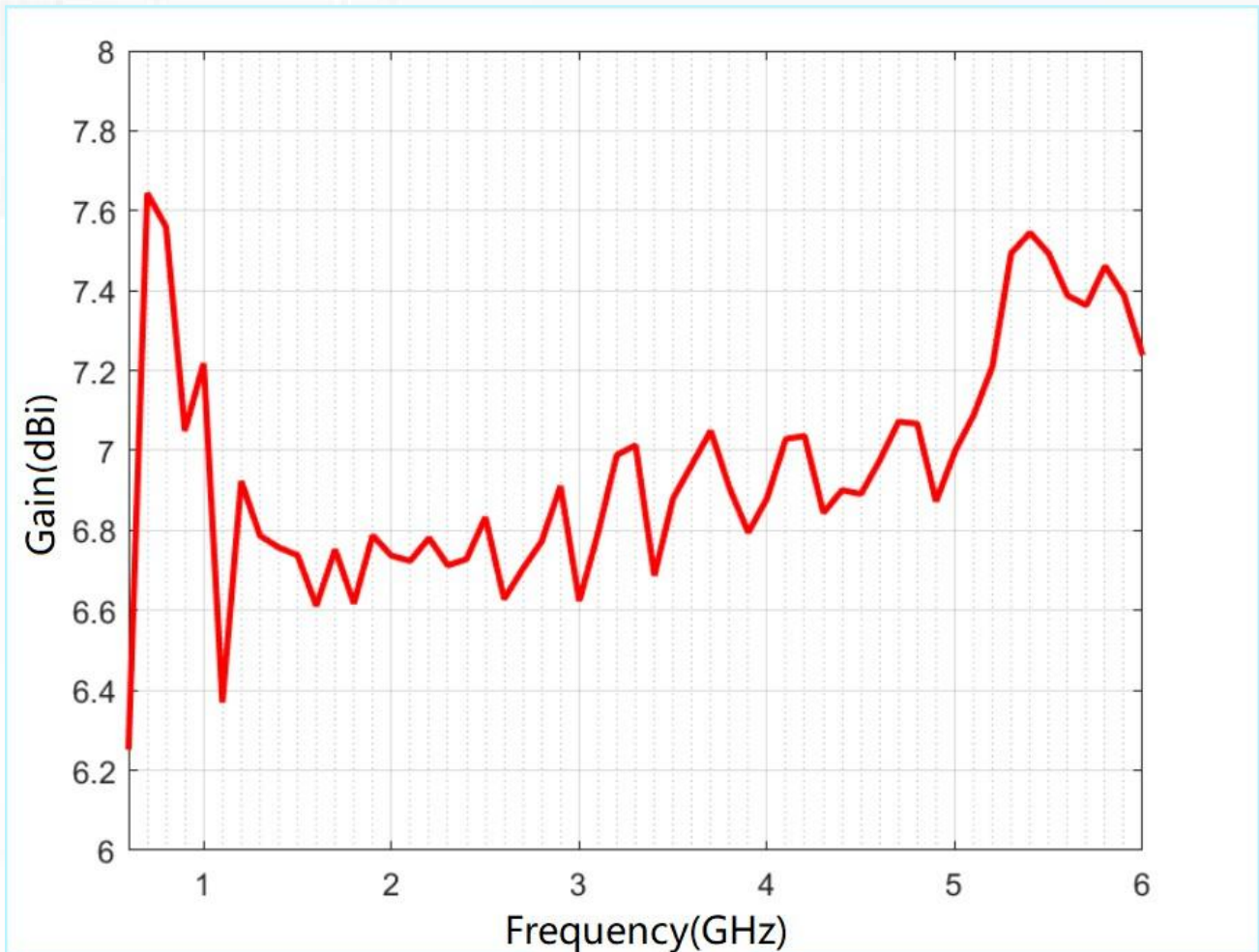

Maswell Ultra Wideband Log Periodic Antenna

Simulation Results

Radiation Patterns

Low Frequency Band (900MHz, 1800MHz) Radiation Pattern

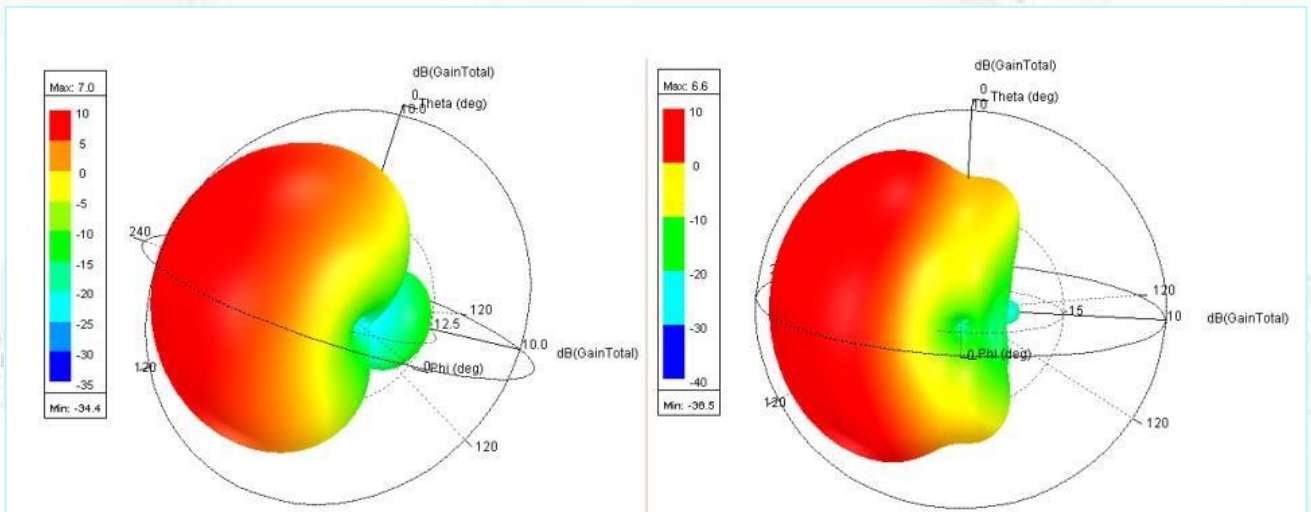

Intermediate Frequency Band (2400MHz, 3500MHz) Radiation Pattern

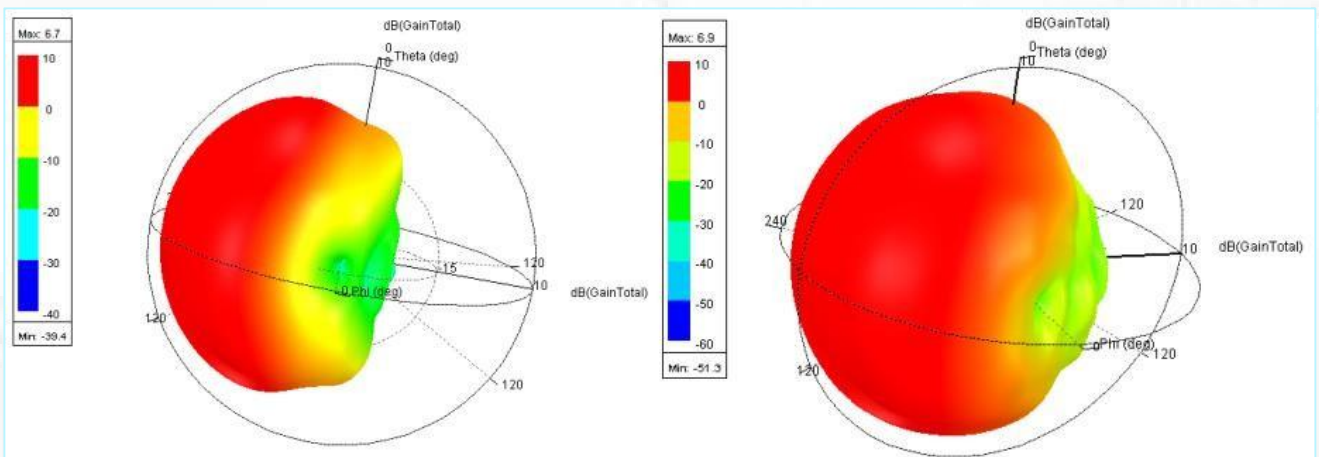

Maswell Ultra Wideband Log Periodic Antenna

Simulation Results

High Frequency Band (4800MHz, 5800MHz) Radiation Pattern

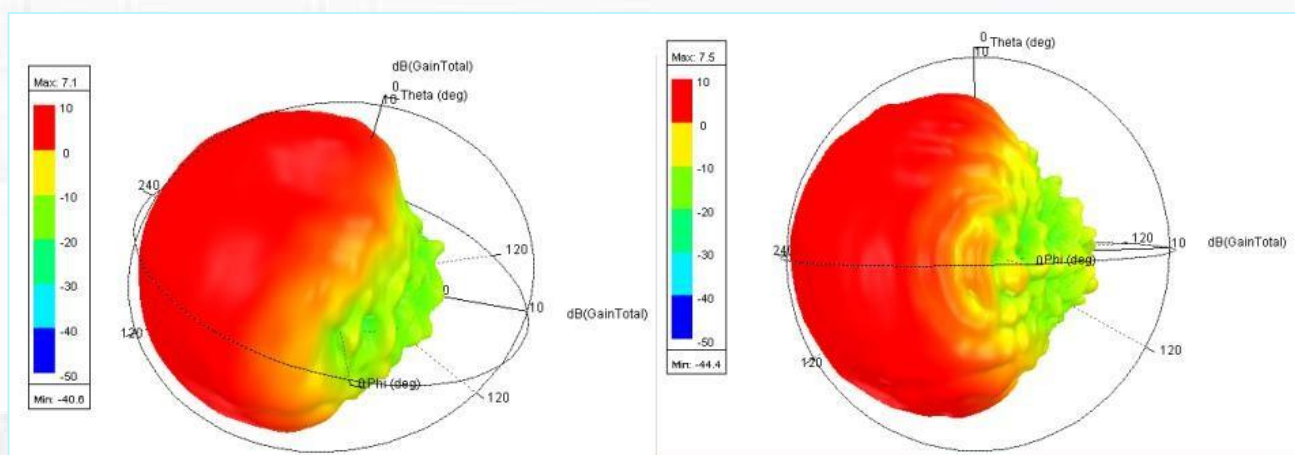

Maswell Ultra Wideband Log Periodic Antenna

Measured Results

Measured S11 Result

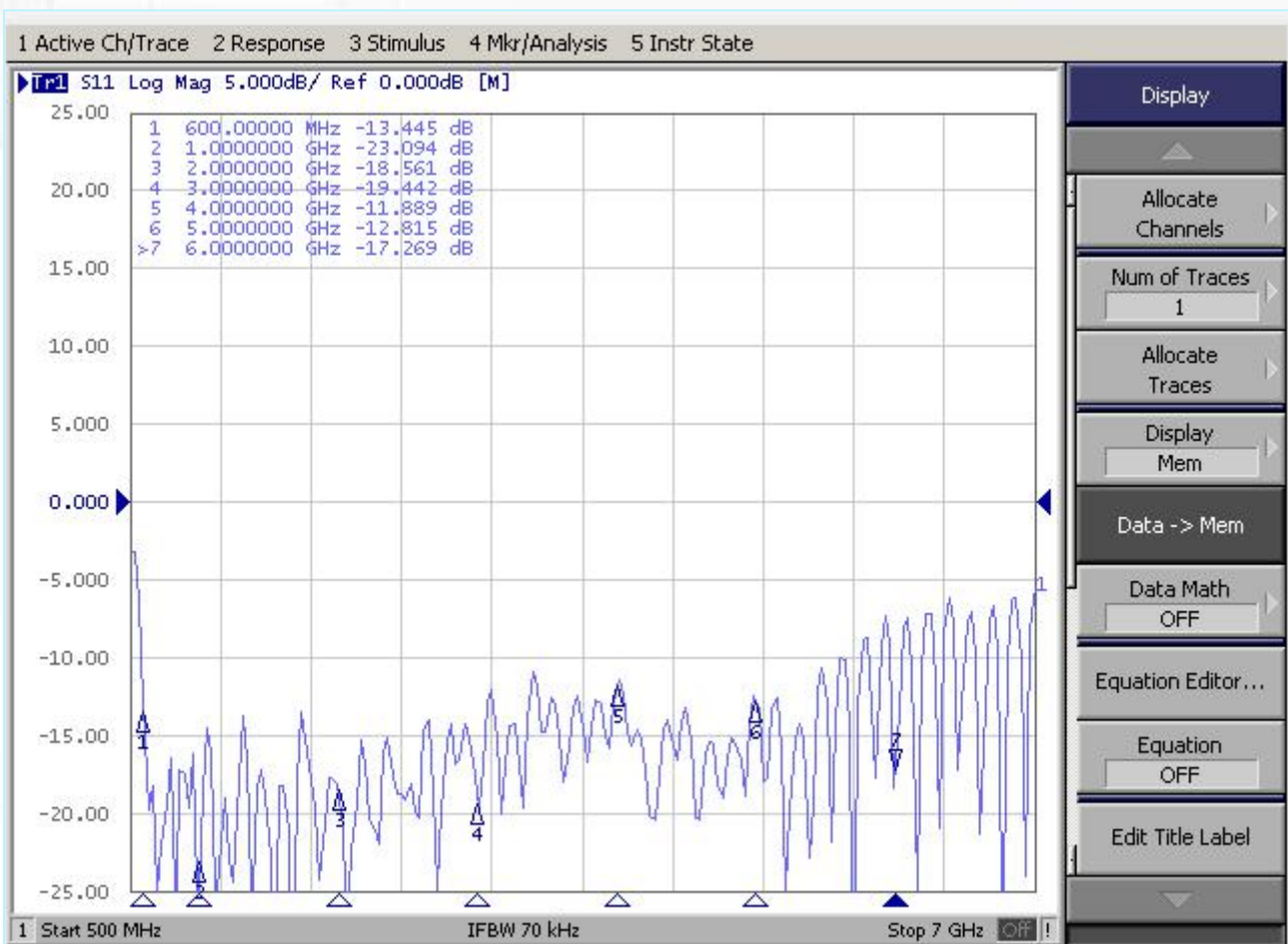

Maswell Ultra Wideband Log Periodic Antenna

Measured Results

Measured VSWR Result

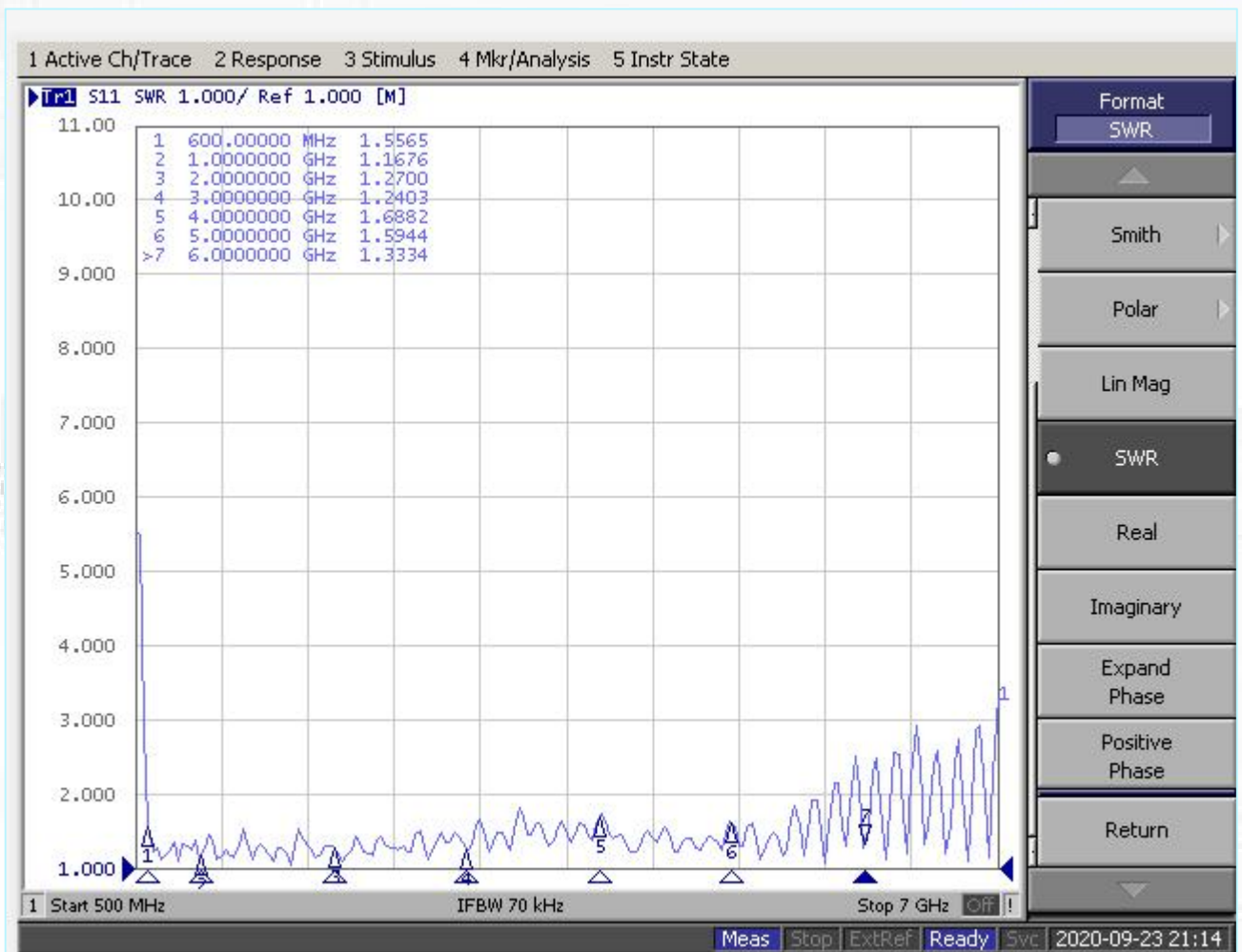

Maswell Ultra Wideband Log Periodic Antenna

Measured Results

Measured Radiation efficiency

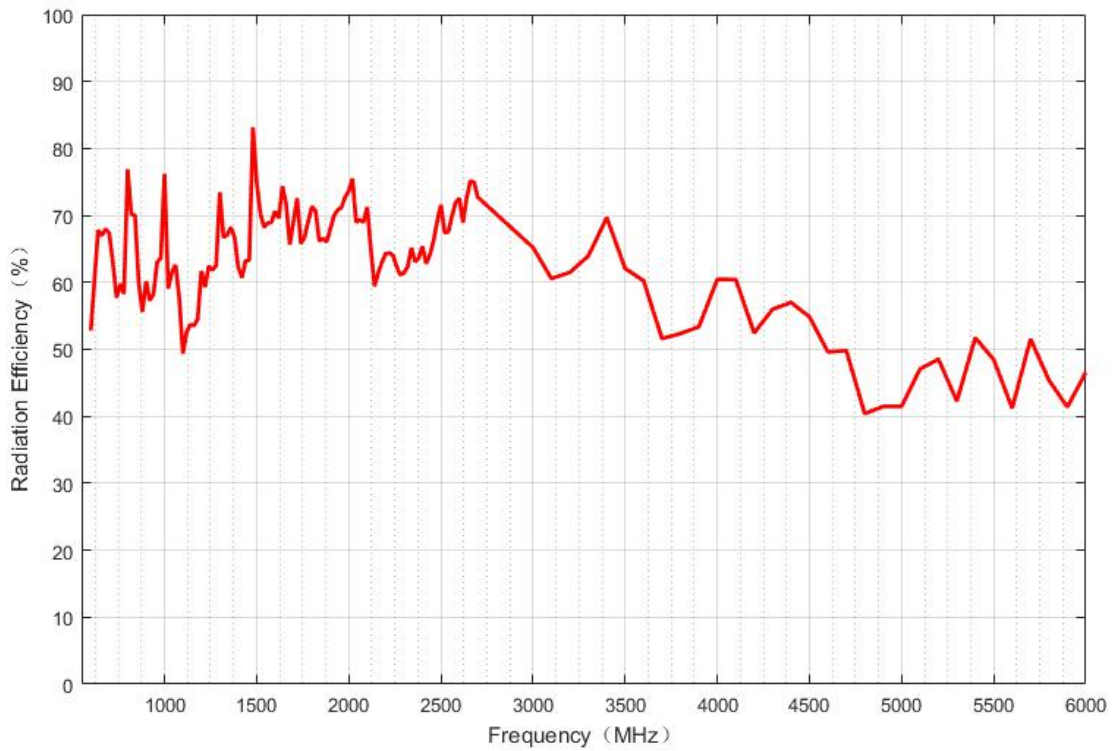

Maswell Ultra Wideband Log Periodic Antenna

Measured Results

Measured Gain Result

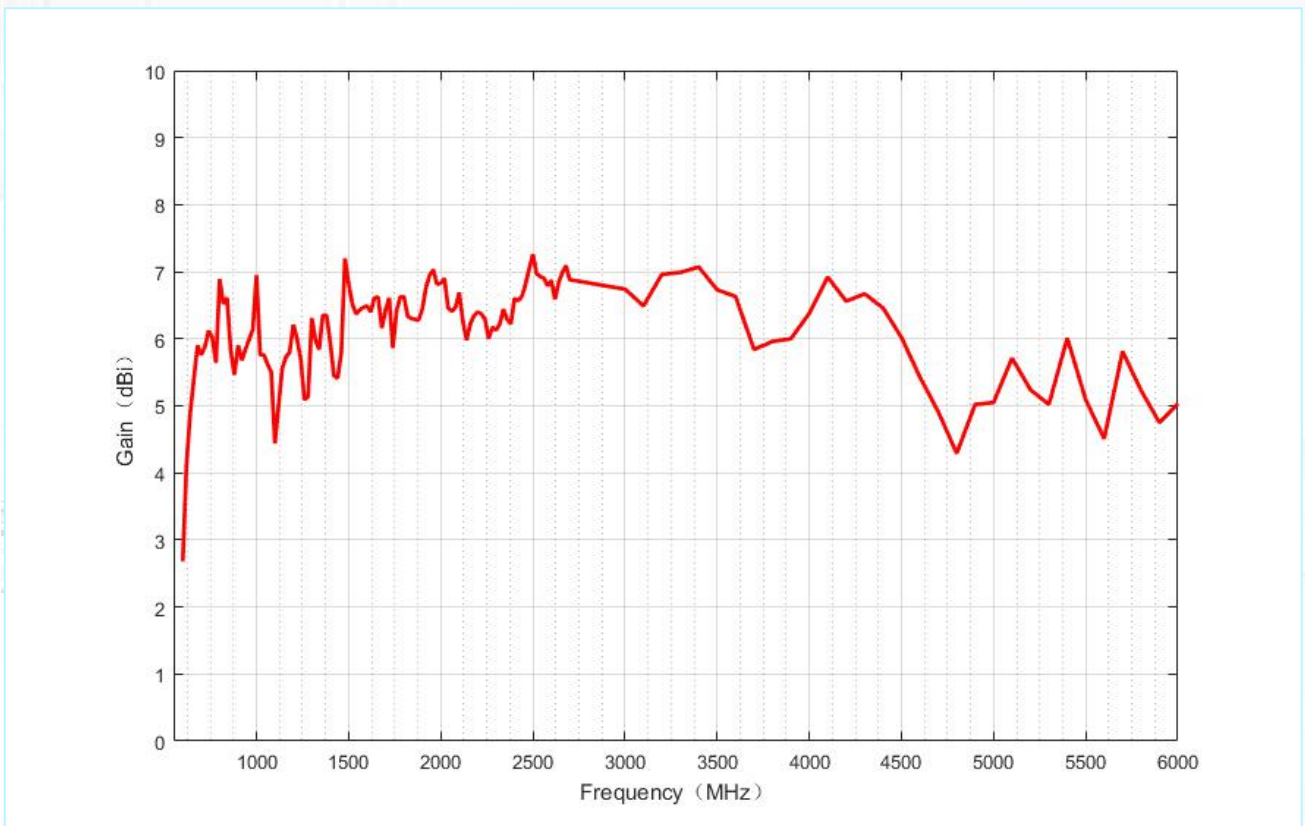

Maswell Ultra Wideband Log Periodic Antenna

Measured Results

Measured Radiation Patterns

600MHz Radiation Pattern

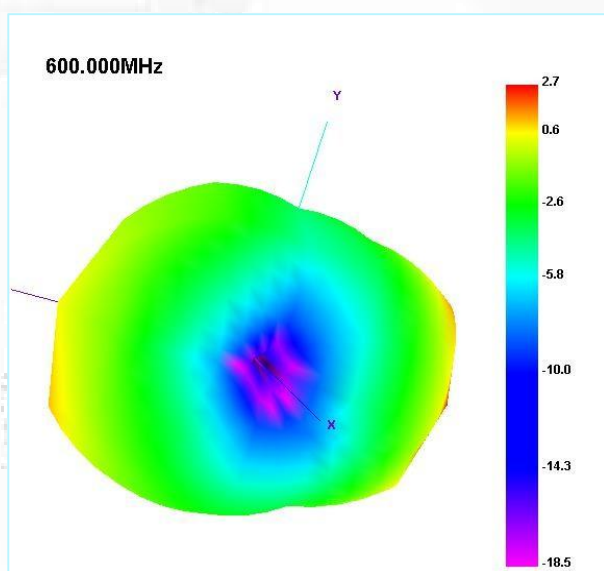

1000MHz Radiation Pattern

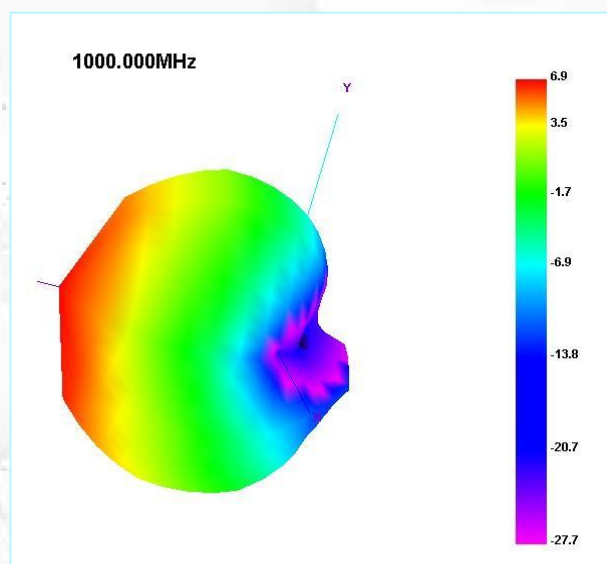

2000MHz Radiation Pattern

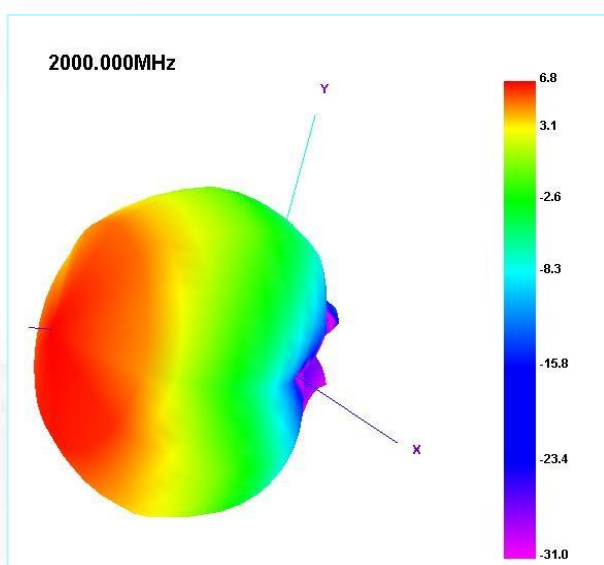

3000MHz Radiation Pattern

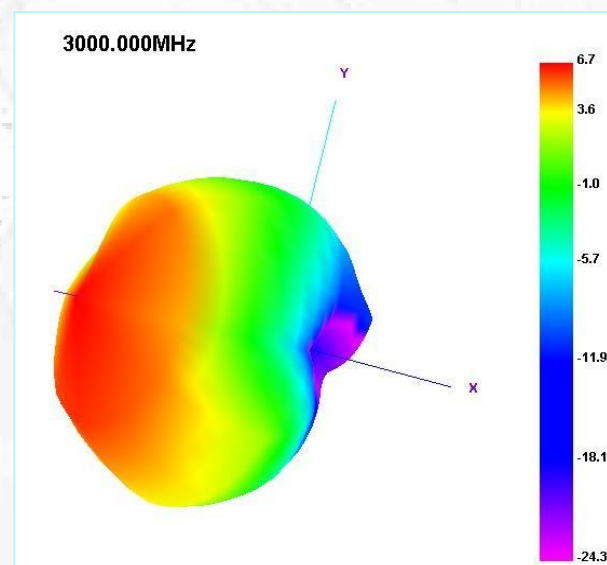

Maswell Ultra Wideband Log Periodic Antenna

Measured Results

Measured Radiation Patterns

4000MHz Radiation Pattern

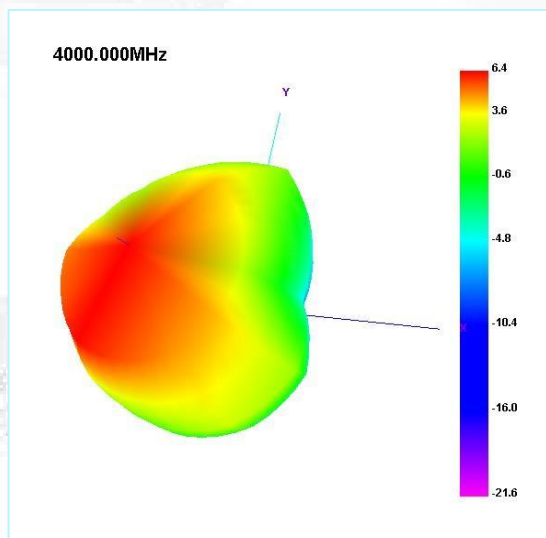

5000MHz Radiation Pattern

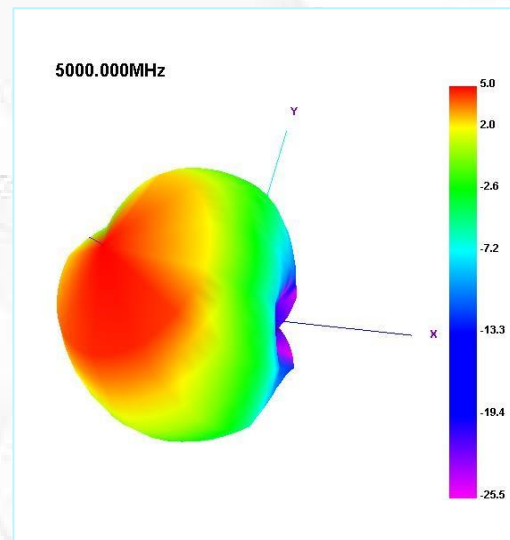

6000MHz Radiation Pattern

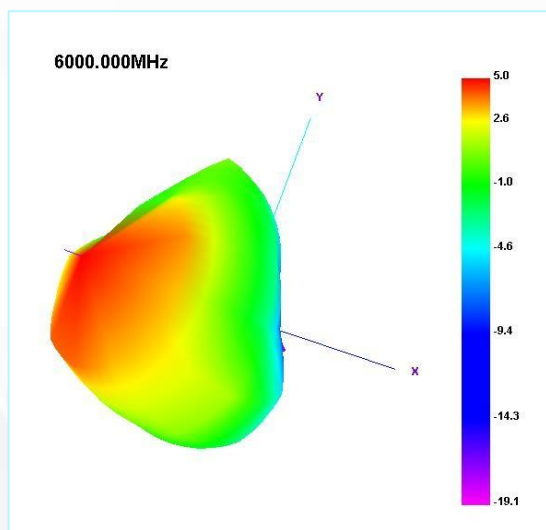

Maswell Ultra Wideband Log Periodic Antenna

Measured Results

(Gain and Radiation Efficiency under 30cm Lead)

Freq (MHz)	Effi (%)	Effi (dB)	Gain (dBi)	Gain (dBd)
600	71.58	-1.45	4.69	2.54
700	63.85	-1.95	5.74	3.59
800	77.4	-1.11	6.9	4.75
900	57.31	-2.42	5.74	3.59
1000	75.74	-1.21	7.18	5.03
1100	46.92	-3.29	4.07	1.92
1200	55.89	-2.53	5.68	3.53
1300	64.01	-1.94	6	3.85
1400	61.69	-2.1	5.74	3.59
1500	70.98	-1.49	6.45	4.3
1600	64.33	-1.92	6.09	3.94
1700	62.76	-2.02	6.23	4.08
1800	62.58	-2.04	6.29	4.14
1900	55.06	-2.59	6.29	4.14
2000	43.07	-3.66	6.4	4.25
2100	49.17	-3.08	5.94	3.79
2200	54.86	-2.61	5.52	3.37
2300	55.19	-2.58	6.1	3.95
2400	61.41	-2.12	6.25	4.1
2500	63.54	-1.97	6.88	4.73
2600	65.45	-1.84	6.88	4.73
2700	64.79	-1.88	6.93	4.78
2800	66.46	-1.77	7.42	5.27
2900	65.37	-1.85	7.53	5.38
3000	62.02	-2.07	6.66	4.51
3100	65.88	-1.81	6.57	4.42
3200	57.42	-2.41	7.32	5.17

Maswell Ultra Wideband Log Periodic Antenna

Measured Results

(Gain and Radiation Efficiency under 30cm Lead)

Freq (MHz)	Effi (%)	Effi (dB)	Gain (dBi)	Gain (dBd)
3300	60.74	-2.17	7.05	4.9
3400	63.54	-1.97	7.13	4.98
3500	58.62	-2.32	6.9	4.75
3600	56.02	-2.52	7.09	4.94
3700	52.87	-2.77	6.89	4.74
3800	51.69	-2.87	6.23	4.08
3900	53.37	-2.73	6.74	4.59
4000	60.6	-2.18	7.18	5.03
4100	59.25	-2.27	7.37	5.22
4200	54.17	-2.66	6.95	4.8
4300	55.15	-2.58	6.96	4.81
4400	56.24	-2.5	6.9	4.75
4500	55	-2.6	6.92	4.77
4600	49.63	-3.04	6.56	4.41
4700	47.15	-3.26	6.41	4.26
4800	47.17	-3.26	6.31	4.16
4900	44.73	-3.49	6.25	4.1
5000	44.37	-3.53	6.12	3.97
5100	46.63	-3.31	6.57	4.42
5200	45.75	-3.4	6.28	4.13
5300	46.4	-3.34	6.55	4.4
5400	49.82	-3.03	6.77	4.62
5500	46.17	-3.36	7.01	4.86
5600	46.68	-3.31	6.74	4.59
5700	44.3	-3.54	6.79	4.64
5800	48.92	-3.11	6.99	4.84
5900	43.54	-3.61	6.31	4.16
6000	37.35	-4.28	5.55	3.4

Maswell Ultra Wideband Log Periodic Antenna Package

AN_Master_004 MIMO

Package with five cartons:

1pc Low Loss Coaxial Cable per Carton

Cable Dimension: 340*60*340mm

Cable Gross Weight: 1150g

Cable Net Weight: 870g

unit : mm

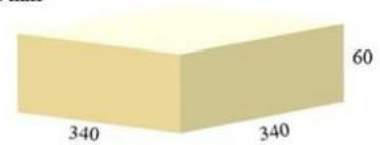

1pc LPDA Antenna Medium Gain per Carton

Antenna Dimension: 230*85*590mm

Antenna Gross Weight: 1400g

Antenna Net Weight: 990g

unit : mm

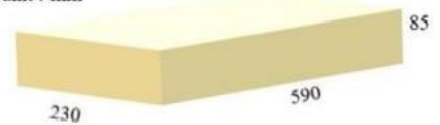

Installation Kit: U bolt

Dimension: 450*90*20mm

Weight: 1125g

