

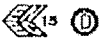

THIS INFORMATION IS CONFIDENTIAL AND PROPRIETARY TO CW INDUSTRIES INCORPORATED AND ITS AFFILIATES. IT MAY NOT BE DISCLOSED TO ANYONE, OTHER THAN CW INDUSTRIES PERSONNEL, WITHOUT WRITTEN AUTHORIZATION FROM CW INDUSTRIES INCORPORATED, SOUTHAMPTON, PENNSYLVANIA USA.

Rating	16(4)A 250V AC   US		Mounting Hole	Circuit
	Contact Resistance	50m ohm Max.		
Insulation Resistance	DC 500V 100M ohm Min.			
Dielectric Strength	AC 1500V 1 minute			
Switch Function	4P DPST ON - (OFF)			
Operation Temp.	0° C ~ 85° C			

() = Momentary Function

MATERIAL:

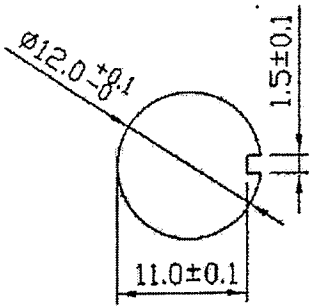
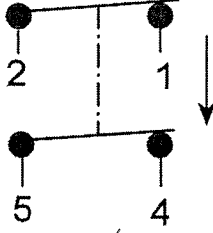
- Frame: Nylon 6/6, Black
- UL Flame: 94-V0
- Lever: Nylon 66+30%GF
- UL Flame: 94-V0
- Terminal: Copper Alloy

Water proof and Dust Proof
to fit IP-56

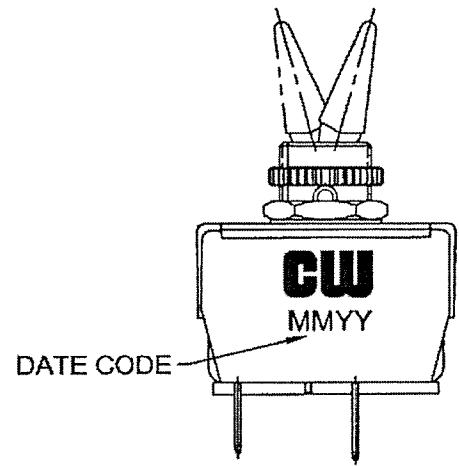
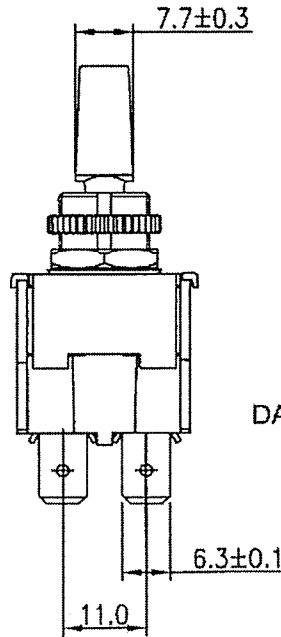
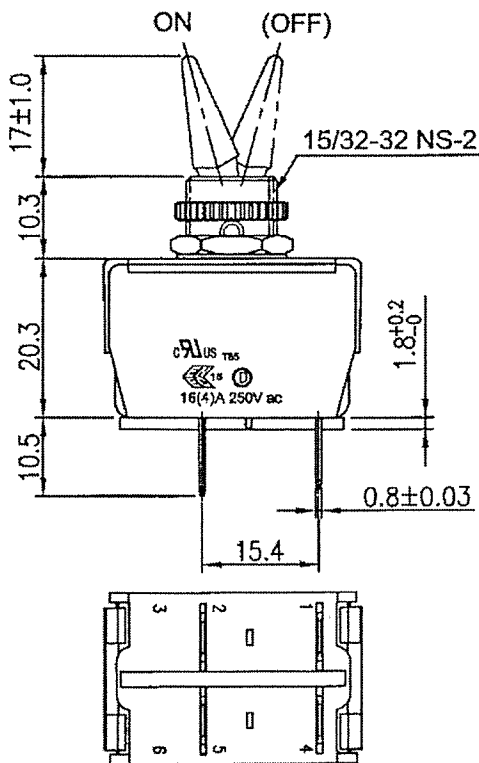
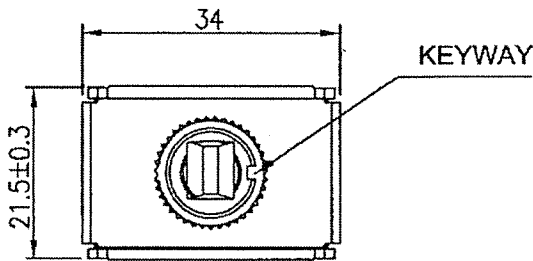

Tolerances Unless Otherwise Specified +/-0.5.

RoHS Compliant

1 Updated material notes. 3-21-13.

CW INDUSTRIES
Southampton, Pa. 18966
Tel 215.355.7080/www.cwind.com

Date Drawn: 8/13/12

Rev. 1

Unit: mm

Checked By: *G. Guld*

Title:
TOGGLE SWITCH

CW P/N:
GTS448Q301AHR