

# ***bq27741EVM Single-Cell Impedance Track™ Technology Evaluation Module***

This evaluation module (EVM) is a complete evaluation system for the bq27741-G1. The EVM includes one bq27741 circuit module, a current sense resistor, two thermistors, and two protection N-FETs. An EV2400 PC interface board and a PC USB cable are required for gas gauge interface, but must be ordered separately. The circuit module includes one bq27741 integrated circuit and all other onboard components necessary to monitor and predict capacity for a pack-side fuel gauge solution and to perform the protection. The circuit module connects directly across the battery cell. With the EV2400 interface board and software, the user can read the bq27741 data registers, program the chipset for different pack configurations, log cycling data for further evaluation, and evaluate the overall functionality of the bq27741 solution under different charge and discharge conditions. The latest Windows™-based PC software can be downloaded from the product folder on the Texas Instruments Web site.

## **Contents**

1	Features .....	2
2	bq27741-Based Circuit Module .....	2
3	Circuit Module Physical Layouts, Bill of Materials, and Schematic .....	3
4	EVM Hardware and Software Setup .....	8
5	Troubleshooting Unexpected Dialog Boxes .....	8
6	Hardware Connection .....	8
7	Operation .....	11
8	Calibrate Screen .....	14
9	Firmware Screen .....	16
10	Preparing the Mass Production File .....	17
11	Send HDQ Screen .....	23
12	Related Documentation From Texas Instruments .....	23

## **List of Figures**

1	bq27741EVM Layout, Silk Screen .....	3
2	Top Assembly .....	4
3	Top Layer .....	4
4	Bottom Layer .....	4
5	Schematic .....	7
6	bq27741 Circuit Module Connection to Cell and System Load/Charger .....	9
7	GaugeStudio Screen .....	11
8	DataMemory Screen .....	12
9	Calibration Screen .....	14
10	Firmware Screen .....	16
11	bqCONFIG Screen .....	17
12	Configuration Parameters Screen .....	18
13	Calibration Averaging Tool Screen .....	19
14	Chemistry Screen .....	20
15	Learning Cycle Screen .....	21
16	Create Image Files Screen .....	22

**List of Tables**

1	Ordering Information.....	2
2	Bill of Materials .....	5
3	Performance Specification Summary.....	8
4	Circuit Module to EV2300 Connections – I <sup>2</sup> C.....	10
5	Circuit Module to EV2300 Connections – HDQ .....	10

## 1 Features

- Complete evaluation system for the bq27741 gas gauge with Impedance Track™ Technology
- Populated circuit module for quick setup
- Personal computer (PC) software and interface board for easy evaluation
- Software that allows data logging for system analysis
- Ability to upgrade to the latest firmware version by flash reprogramming

### 1.1 Kit Contents

- bq27741 circuit module

This EVM is used for the evaluation of different bq27741-based products. Please ensure that you visit the product Web folder at <http://www.ti.com> to download the latest firmware version, evaluation software, and documentation for the associated product to be evaluated.

### 1.2 Ordering Information

**Table 1. Ordering Information**

EVM Part Number	Chemistry	Configuration	Capacity
bq27741EVM	Li-Ion	1 cell	Any

## 2 bq27741-Based Circuit Module

The bq27741-based circuit module is a complete and compact example solution of a bq27741 circuit for battery management. The circuit module incorporates a bq27741 battery gas gauge IC, dual N-FETs for high-side protection, and all other components necessary to protect and accurately predict the capacity of a 1-series Li-Ion cell.

### 2.1 Circuit Module Connections

Contacts on the circuit module provide the following connections:

- Direct connection to the battery cell (TB1 or TP1/TP2): CELL+ and CELL–
- Connect a charger power to TB2: PACK+ and PACK–, or short the PACK+ and CELL+ to wake up the gauge, then remove the connection of PACK+ and CELL+ or the charger
- To the serial communications port: SDA, SCL, and VSS (J10) or HDQ and VSS (J8)
- The system load and charger connect across charger and load (TB2 or TP9/TP10): PACK–/LOAD– and PACK+/LOAD+.

Impedance Track is a trademark of Texas Instruments.  
 Windows is a trademark of Microsoft Corporation.  
 Microsoft is a registered trademark of Microsoft Corporation.  
 I<sup>2</sup>C is a trademark of NXP B.V Corporation.

## 2.2 Pin Descriptions

Pin Name	Description
PACK+	Pack positive terminal
PACK-	Pack negative terminal
CELL+	Cell positive terminal
CELL-	Cell negative terminal
TERM	Thermistor input that leads to IC TS pin
SDA	I <sup>2</sup> C communication data line
SCL	I <sup>2</sup> C communication clock line
HDQ	Single-wire communication line
VSS	Signal return for communication line

## 3 Circuit Module Physical Layouts, Bill of Materials, and Schematic

This section contains the printed-circuit board (PCB) layout, bill of materials, assembly drawings, and schematic for the bq27741 circuit module.

### 3.1 Board Layout

This section shows the printed-circuit board (PCB) layers (Figure 1 through Figure 4), assembly drawing, and schematic for the bq27741 module.

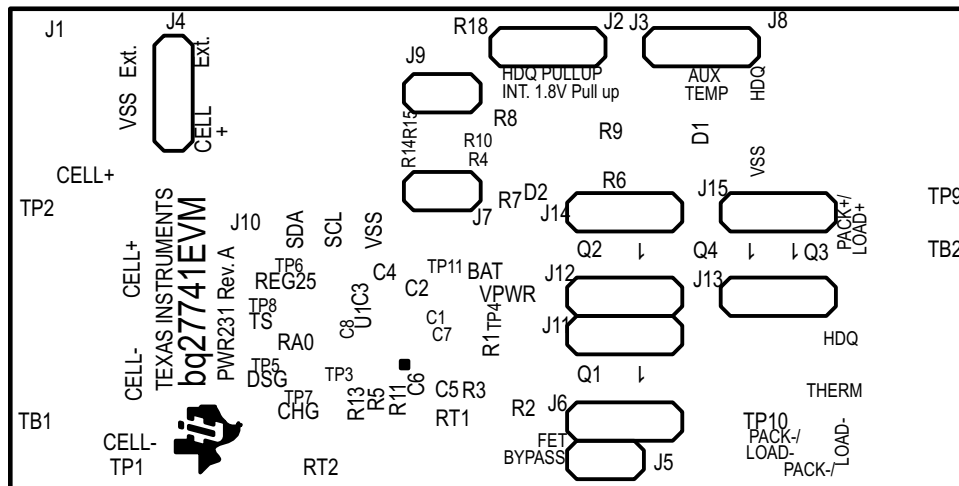

Figure 1. bq27741EVM Layout, Silk Screen

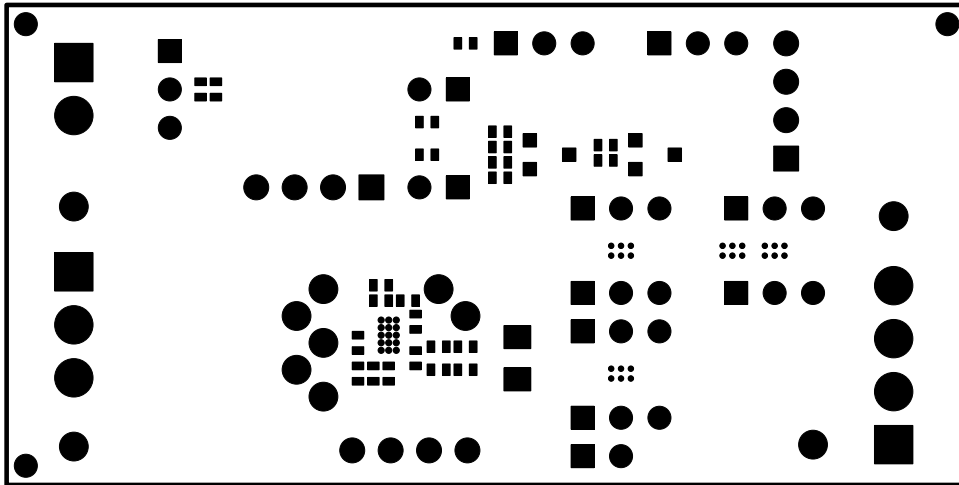

Figure 2. Top Assembly

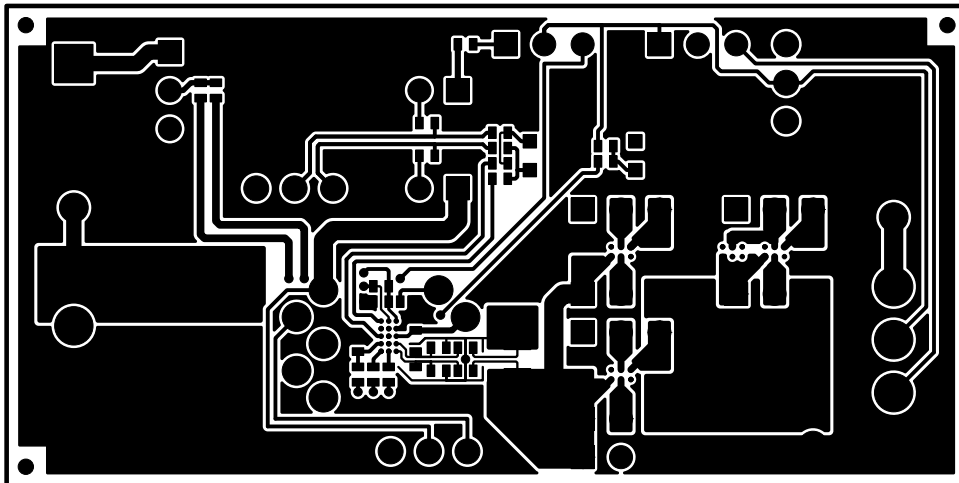

Figure 3. Top Layer

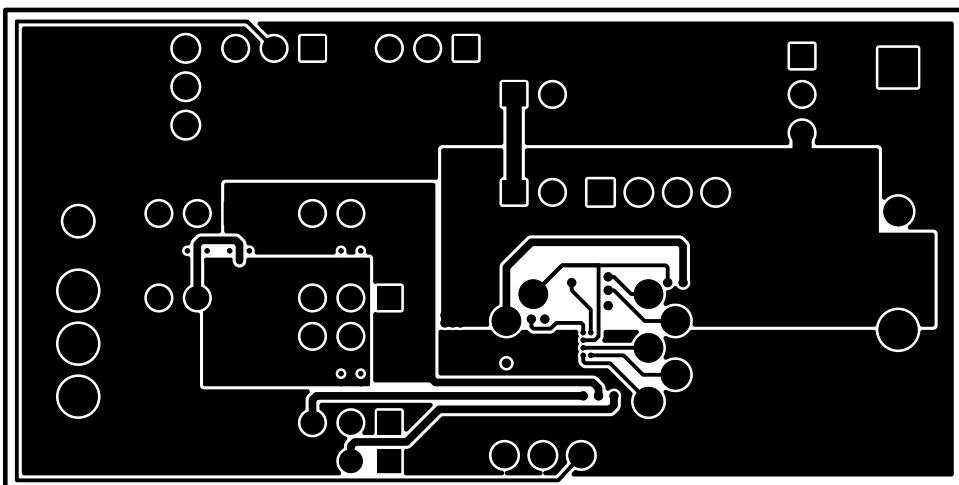

Figure 4. Bottom Layer

### 3.2 Bill of Materials and Schematic

**Table 2. Bill of Materials**

Count	Reference Designator	Value	Description	Size	Part Number	MFR
6	C1, C2, C5, C6, C7, C8	0.1 $\mu$ F	Capacitor, Ceramic, 10 V, X5R, 10%	0402	GRM155R61A104KA01D	Murata
1	C3	1 $\mu$ F	Capacitor, Ceramic, 6.3 V, X5R, 10%	0402	GRM155R60J105KE19D	Murata
1	C4	0.47 $\mu$ F	Capacitor, Ceramic, 0.47 $\mu$ F, 6.3 V, X5R, 10%	0402	GRM155R60J474KE19D	Murata
2	D1, D2	AZ23C5V6-7	Diode, Dual, Zener, 5.6 V, 300 mW	SOT23	AZ23C5V6-7-F	Diodes
1	J1	ED555/2DS	Terminal Block, 2-pin, 6-A, 3.5 mm	0.27 x 0.25 inch	ED555/2DS	OST
9	J2, J3, J4, J6, J11, J12, J13, J14, J15	PEC03SAAN	Header, Male 3-pin, 100mil spacing	0.100 inch x 3	PEC03SAAN	Sullins
3	J5, J7, J9	PEC02SAAN	Header, Male 2-pin, 100mil spacing	0.100 inch x 2	PEC02SAAN	Sullins
2	J8, J10	22-05-3041	Header, Friction Lock Ass'y, 4-pin Right Angle,	0.400 x 0.500	22-05-3041	Molex
1	Q1	UPA2375T1P-E1-A	MOSFET, Dual N-Channel NexFET, 12 V 3.2 A	WSCP	UPA2375T1P-E1-A	Renesas Electronics America
0	Q2, Q3, Q4	DNP	MOSFET, Dual N-Channel NexFET, 12 V 3.2 A	WSCP	UPA2375T1P-E1-A	Renesas Electronics America
2	R1, R3	200 $\Omega$	Resistor, Chip, 1/16-W, 5%	0402	CRCW0402200RJNED	Vishay Dale
1	R12	4.7 k $\Omega$	Resistor, Chip, 1/16-W, 5%	0402	CRCW04024K70JNED	Vishay Dale
1	R13	2 k $\Omega$	Resistor, Chip, 1/16-W, 5%	0402	CRCW04022K00JNED	Vishay Dale
2	R14, R15	10 k $\Omega$	Resistor, Chip, 1/16-W, 5%	0402	CRCW040210K0JNED	Vishay Dale
2	R16, R17	10 $\Omega$	Resistor, Chip, 1/16-W, 5%	0402	CRCW040210R0JNED	Vishay Dale
1	R2	5 m $\Omega$	Res, Metal Current sense, 1W, $\pm$ 1%, 50 ppm	1632	MCS1632R005FER	Ohmite
6	R4, R6, R7, R8, R9 R10	100 $\Omega$	Resistor, Chip, 1/16-W, 5%	0402	CRCW0402100RJNED	Vishay Dale
2	R5, R11	1 k $\Omega$	Resistor, Chip, 1/16-W, 5%	0402	CRCW04021K00JNED	Vishay Dale
2	RT1, RT2	10 k $\Omega$	Thermistor, 10 k $\Omega$	0.095 x 0.150 inch	103AT-2	Semitec
1	TB1	ED1515	Terminal Block, 3-pin, 6-A, 3.5 mm	0.41 x 0.25 inch	ED555/3DS	OST
1	TB2	ED555/4DS	Terminal Block, 4-pin, 6-A, 3.5 mm	0.55 x 0.25 inch	ED555/4DS	OST
7	TP1, TP4, TP5, TP7, TP8, TP10, TP11	5001	Test Point, Black, Thru Hole Color Keyed	0.100 x 0.100 inch	5001	Keystone
4	TP2, TP3, TP6, TP9	5000	Test Point, Red, Thru Hole Color Keyed	0.100 x 0.100 inch	5000	Keystone
1	U1	bq27741YZFR-G1	IC, Single Cell Li-Ion Pack Side Fuel Gauge with Integrated Protection	BGA-15	bq27741YZFR-G1	TI
1	--		PCB		PWR231	Any

- (1) These assemblies are ESD sensitive, ESD precautions should be observed.
- (2) These assemblies must be clean and free from flux and all contaminants.  
Use of no clean flux is not acceptable.
- (3) These assemblies must comply with workmanship standards IPC-A-610 Class 2.
- (4) Ref designators marked with an asterisk (\*\*\*) cannot be substituted.  
All other components can be substituted with equivalent manufacturer's components.

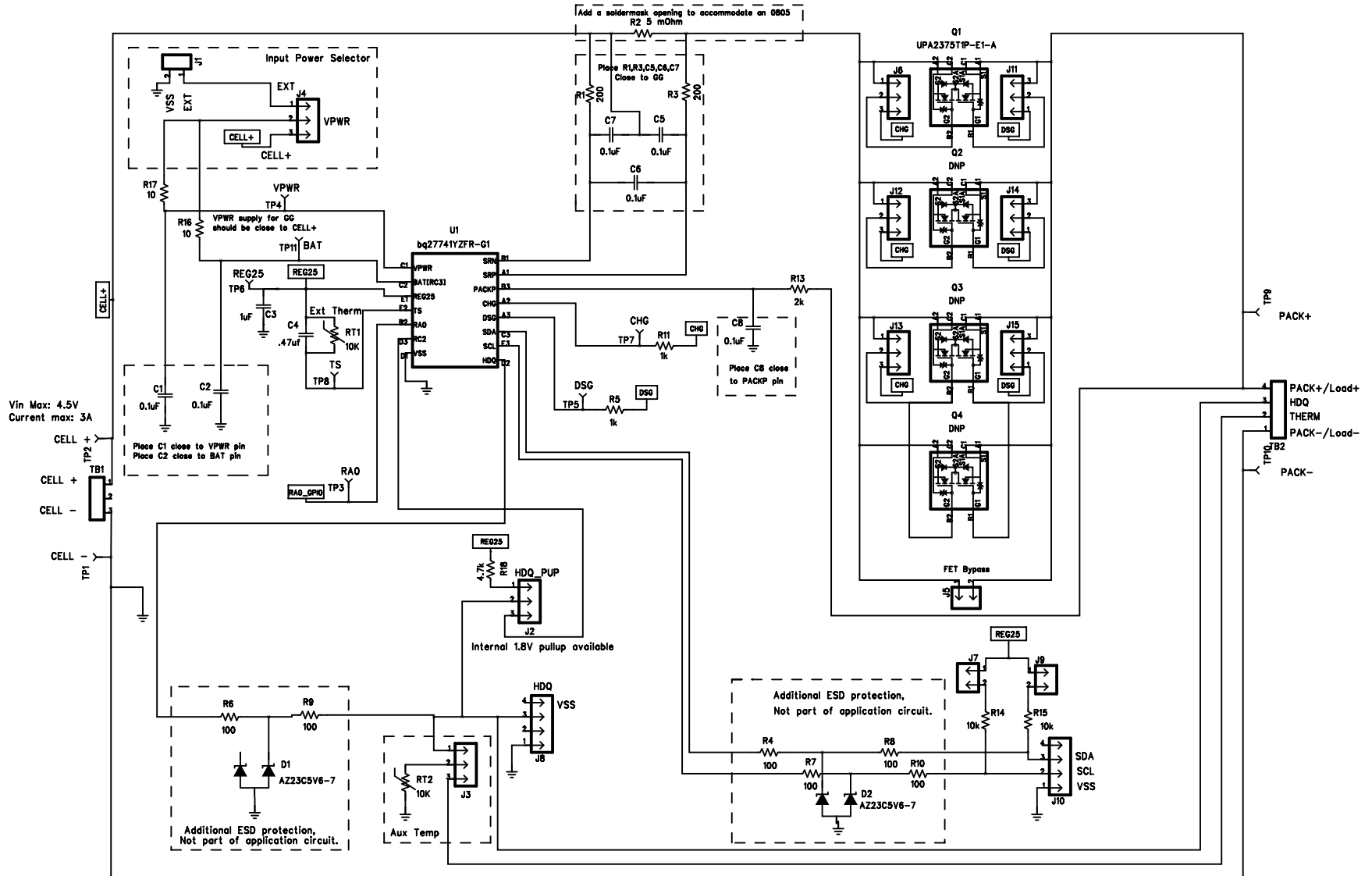

Figure 5. Schematic

### 3.3 bq27741 Circuit Module Performance Specification Summary

This section summarizes the performance specifications of the bq27741 circuit module.

**Table 3. Performance Specification Summary**

Specification	Min	Typ	Max	Unit
Input voltage Pack+ to Pack-	2.7	3.6	4.35	V
Charge and discharge current	0	1	2	A

## 4 EVM Hardware and Software Setup

This section describes how to install the bq27741EVM PC software, and how to connect the different components of the EVM.

### 4.1 System Requirements

The GaugeStudio software requires Windows XP or later. Using later versions of Windows operating system can have issues with the USB driver support. The EV2300 USB drivers have been tested for Windows 98SE, but no assurance is made for problem-free operation with specific system configurations. EV2300 is not officially supported for 64-bit versions of Windows and typically does not work with Windows 7 or newer. EV2400 is the recommended USB-I<sup>2</sup>C interface for Windows 7 and other 64-bit versions.

### 4.2 Software Installation

Find the latest software version in the bq27741 tool folder on [power.ti.com](http://power.ti.com). Make a search by Part Number for bq27741 to access the tool folder. Currently the most recent firmware version is bq27741-G1. Use the following steps to install the bq27741 GaugeStudio software:

1. Ensure that the EV2300 or EV2400 is not connected to the personal computer (PC) through the USB cable before starting this procedure.
2. Open the archive containing the installation package, and copy its contents into a temporary directory.
3. Open the software file that was downloaded from the TI Web site.
4. Follow the instructions on screen until completing the software installation.
5. Before starting the evaluation software, connect the EV2300 or EV2400 to the computer using the USB cable.
6. If EV2300 is connected, wait until system prompt *New Hardware Found* appears. Choose *Select Location Manually*, and use the **Browse** button to point to subdirectory TIUSBWin2K-XP-1.
7. Answer **Continue** to the warning that drivers are not certified with Microsoft®
8. If the EV2300 is connected, after the previous installation finishes, another system prompt *New Hardware Found* appears. Repeat steps through 5, but specify the directory as TIUSBWin2K-XP-2.
9. Answer **Continue** to the warning that drivers are not certified with Microsoft. Driver installation is now finished.
10. For the EV2400, the driver should be installed along with software installation.

## 5 Troubleshooting Unexpected Dialog Boxes

The user who is downloading the files must be logged in as the administrator. The driver is not signed, so the administrator must allow installation of unsigned drivers in the operating system. If using Windows 7, install the software with administrator privileges.

## 6 Hardware Connection

The bq27741EVM-001 comprises three hardware components:

- bq27741 circuit module
- EV2300 PC interface board



- PC

### 6.1 Connecting the bq27741 Circuit Module to a Battery Cell

Figure 6 shows how to connect the bq27741 circuit module to the cell and system load/charger.

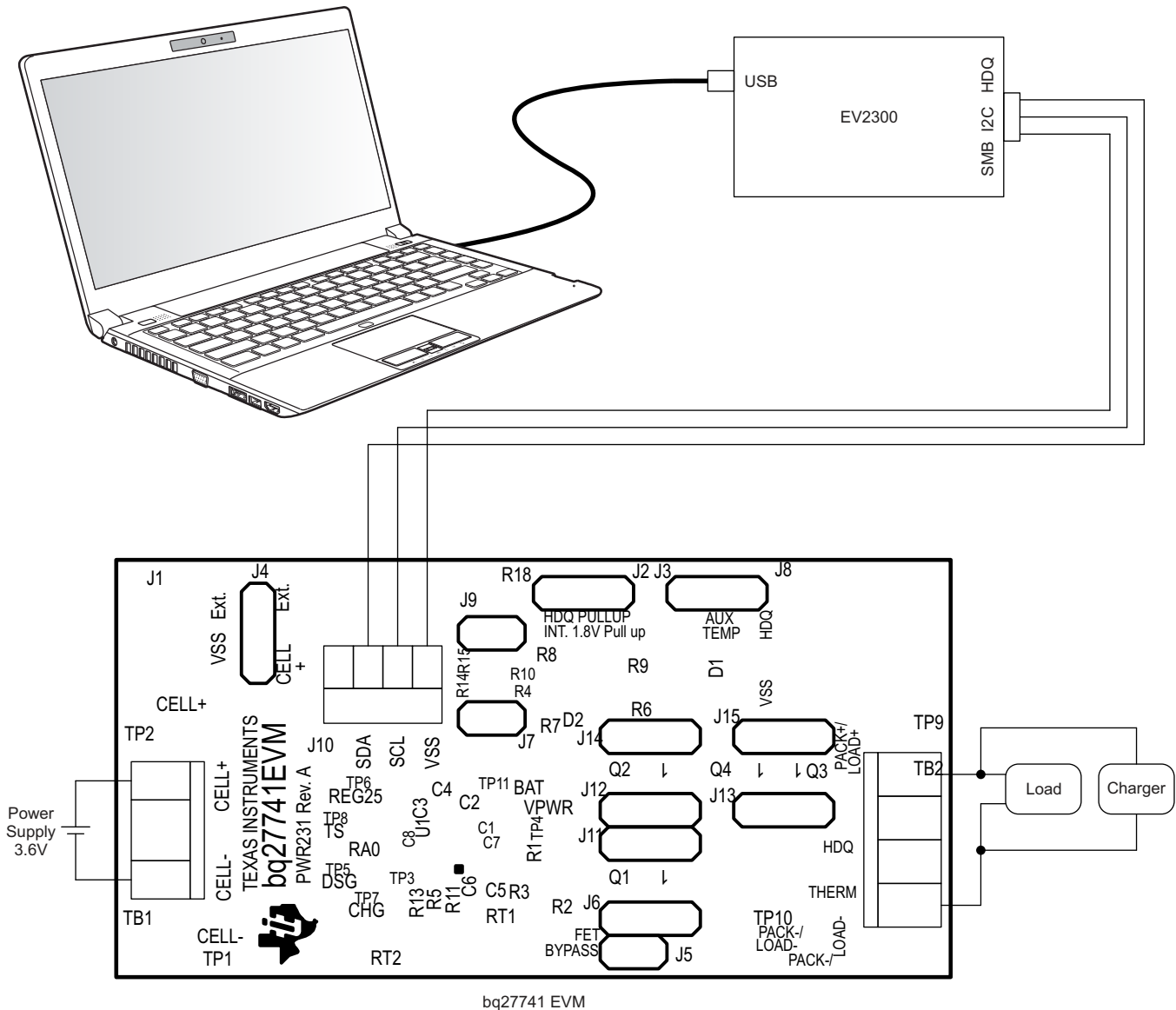

Figure 6. bq27741 Circuit Module Connection to Cell and System Load/Charger

### 6.2 PC Interface Connection

The bq27741 can be configured as an HDQ communication device or left in default as an I<sup>2</sup>C™ device. Once the bq27741 is configured for HDQ communication, it cannot be reverted to I<sup>2</sup>C mode. See Section 11 for information on configuring the bq27741 to HDQ mode.

The following steps configure the hardware for interfacing to the PC:

1. Connect the bq27741-based EVM to the EV2300 using wire leads as shown in Table 4 and Table 5.

**Table 4. Circuit Module to EV2300 Connections – I<sup>2</sup>C**

<b>bq27741-Based Battery (I<sup>2</sup>C Mode)</b>	<b>EV2300 (I<sup>2</sup>C Port)</b>
SDA	SDA
SCL	SCL
VSS	GND

**Table 5. Circuit Module to EV2300 Connections – HDQ**

<b>bq27741-Based Battery (HDQ Mode)</b>	<b>EV2300 (HDQ Port)</b>
HDQ	HDQ
VSS	GND

2. Connect a charger to wake-up the gauge, can use a power supply between PACK+ and PACK– or short CELL+ and PACK+. After wake-up, the charger can be removed.
3. Connect the PC USB cable to the EV2300 and the PC USB port.

The bq27741EVM is now set up for operation.

## 7 Operation

This section details the operation of the GaugeStudio software.

### 7.1 Starting the Program

Run GaugeStudio from the Start → Programs → Texas Instruments → GaugeStudio menu sequence. The main GaugeStudio window (see Figure 7) appears. The window consists of a tools panel at the top, and other child windows that can be hidden, docked in various positions or allowed to float as separate windows.

When GaugeStudio first starts up the *Gauge Dashboard* window, the *Registers* window, and *DataMemory* window should be seen in the main window. *Registers*, *DataMemory*, *Commands*, and other windows can be added to the main window by clicking on the corresponding icon in the tools panel at the top of the main window.

Data should appear initially in the *Gauge Dashboard*, *Registers*, and *DataMemory* sections. The **Refresh** (single-time scan) or the **Scan** (continuous scan) buttons can be clicked to update the data in the *Registers* and *DataMemory* windows. The continuous scan is enabled when the *Scan* checkbox is highlighted green and disabled when the *Scan* checkbox is not highlighted.

The continuous scanning interval can be set with the *stopwatch* icon next to the **Scan** button. When the *stopwatch* icon is clicked, a drop-down menu appears and the desired scanning interval can be selected. The scan interval value shows up next to the *stopwatch* icon.

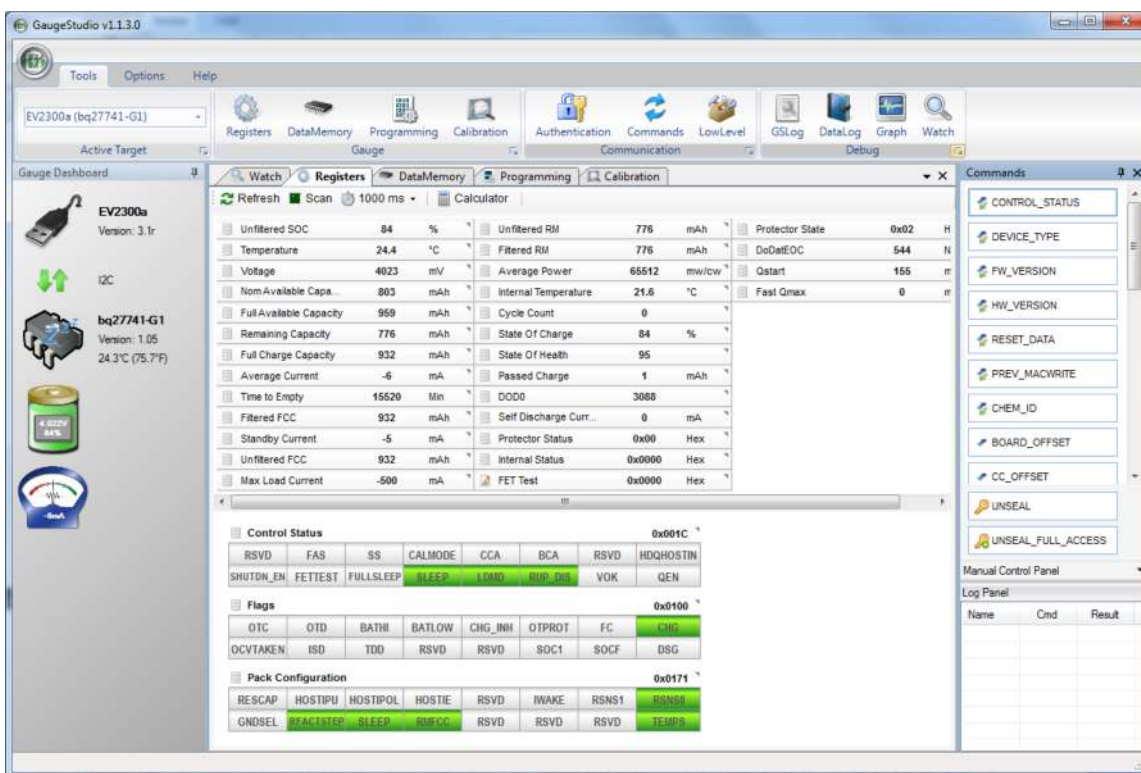

Figure 7. GaugeStudio Screen

GaugeStudio provides a logging function which logs selected Data Registers and Data Memory values last received from the bq27741. To enable this function, click the *DataLog* icon in the *Tools* panel. The *DataLog* window will appear below the *Registers* and *DataMemory* windows. Registers and DataMemory parameters can be added to the log by clicking on the *Add Register* and *Add DataMemory Parameter* drop-down menus in the *DataLog* window and then selected the desired Registers or DataMemory parameters to be added to the log. After all the desired Registers and DataMemory parameters have been added to the log, click the **Play** button in order to begin logging. A **Stop** button will replace the **Play** button once logging starts, the **Stop** button can be clicked to stop logging. The log can be saved by clicking on the *Save* icon and specifying a file name.

The logging intervals are specified by the value next to the *stopwatch* icon in the *DataLog* window. In order to change the logging intervals, click the *stopwatch* icon and choose one of the intervals provided in the menu selections that appear. Logging interval values will show up next to the *stopwatch* icon.

Figure 7 shows the main *GaugeStudio* window. Additional Flag and Status data can be viewed at the bottom of the *Registers* window.

Each window can be resized and docked in various positions within the main *GaugeStudio* window. Each window can also be pulled out from the main window and allowed its own floating window. Also, the *Gauge Dashboard* window and all windows that are enabled in the *Tools* panel in the *Communication* and *Debug* sections can be set to autohide.

## 7.2 Setting Programmable bq27741 Options

The bq27741 data flash comes configured per the default settings detailed in the bq27741 data sheet (SLUSBF2). Ensure that the settings are correctly changed to match the pack and application for the bq27741 solution being evaluated.

**IMPORTANT:** The correct setting of these options is essential to get the best performance. The settings can be configured using the *DataMemory* window seen in the main *GaugeStudio* window (see Figure 8).

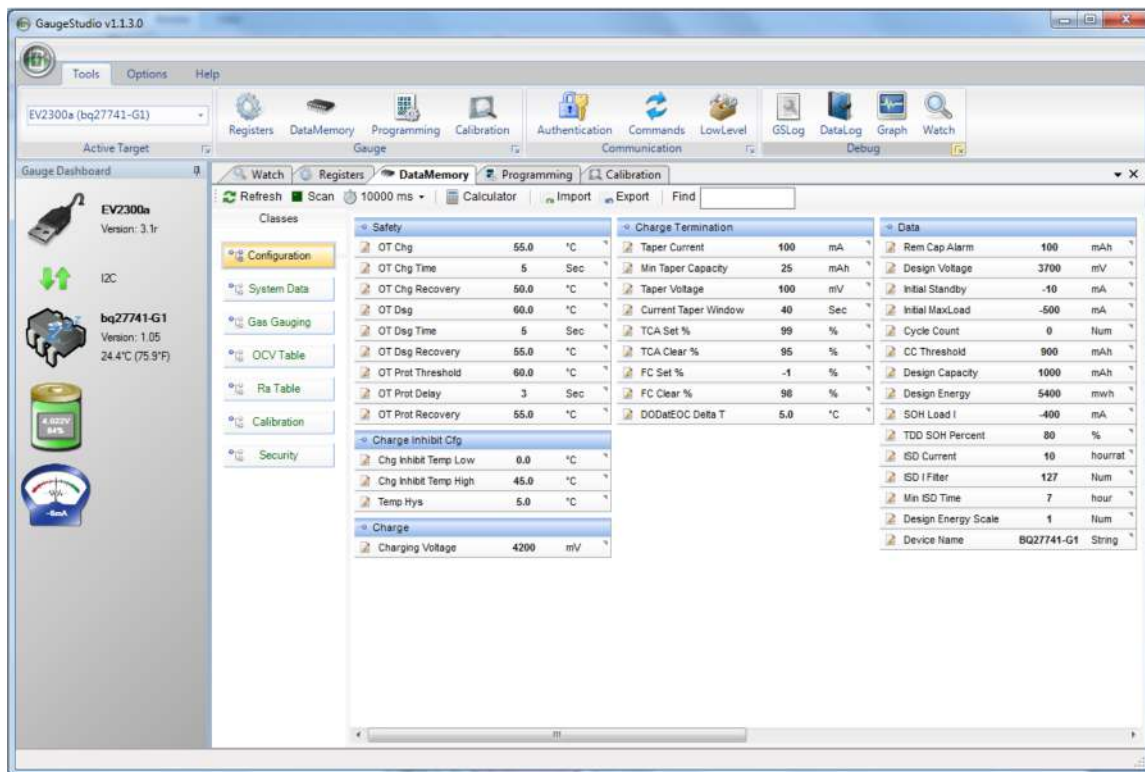

Figure 8. DataMemory Screen

To read all the data flash from the bq27741, click on the Refresh button in the *DataMemory* window.

To write to a data flash location, click on the desired location, enter the data in dialog box and click “OK” or hit the Enter key. The data flash must be read before any writes are performed to avoid any incorrect data being written to the device. Reading the data after any writes is also recommended.

The data-flash configuration can be saved to a file by clicking the Export button and entering a file name. A data-flash file also can be retrieved in this way by clicking the Import button. The exported file has a *.gg* extension and can be opened and edited with a text editor. It does not contain all of the data flash. It only contains the public volatile parameters and should not be used for production programming. The *.senc*, *.dfi*, *.dffb*, *.bqfs*, or *.dmi* file should be used for production as these contain the entire data flash image, including hidden static parameters such as the battery profile.

The module calibration data is also stored in the bq27741 data flash.

## 8 Calibrate Screen

To ensure proper calibration, perform the following steps. These steps may or may not be required, depending on the type of calibration being performed. Only one calibration item can be selected and calibrated at a time.

### 8.1 To Calibrate the bq27741

Calibrate each item one at a time in the order presented in this document. Select the types of calibration to be performed by clicking the corresponding button (see Figure 9).

Enter the measured values for the types selected, if necessary.

Then press the “Calibrate” button. After all calibration is complete, close the Calibrate screen.

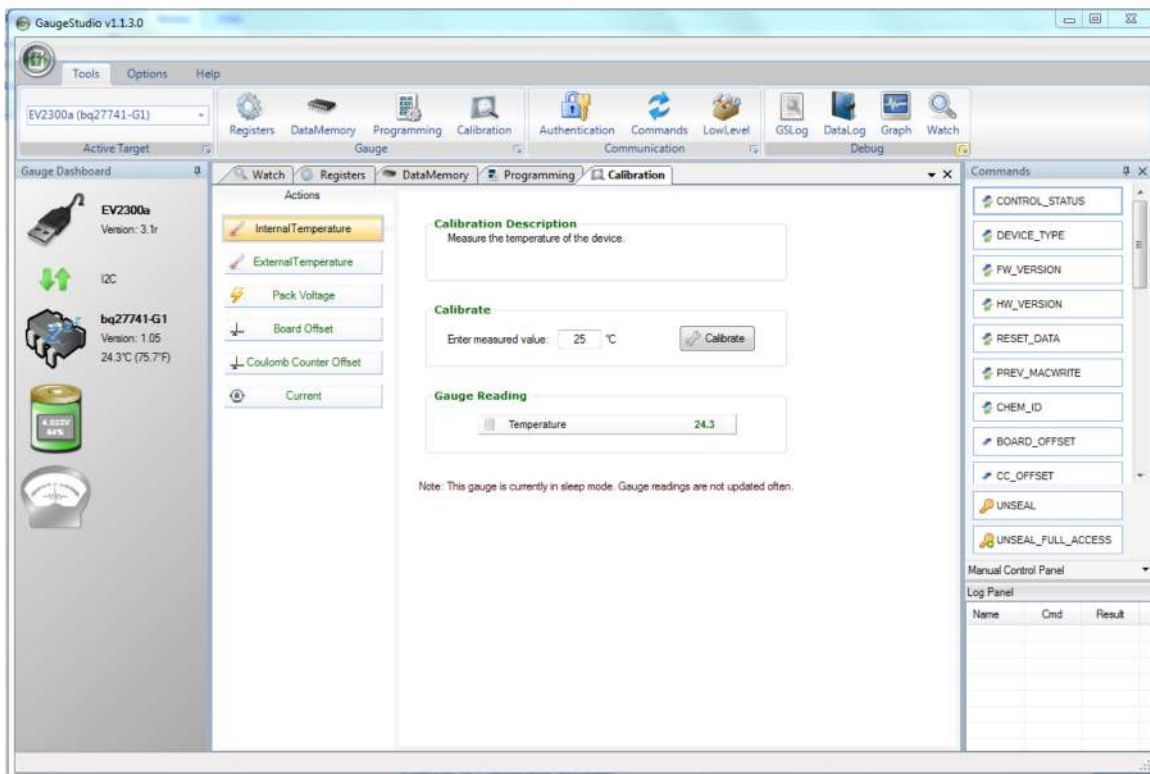

Figure 9. Calibration Screen

### 8.2 Temperature Calibration

- Select if the temperature sensor to calibrate is the internal or the external.
- Measure the temperature for PACK.
- Type the temperature value into *Enter measured value*.
- Press the Calibrate button.

### 8.3 Pack Voltage Calibration

- Measure the voltage across Pack+ and Pack– with a calibrated meter.
- Type the voltage value in mV into *Enter measured value*.
- Press the Calibrate button.

#### **8.4 Coulomb Counter Offset Calibration**

This performs the internal calibration of the coulomb counter input offset. Press the *Calibrate Part as indicated below* button.

#### **8.5 Board Offset Calibration**

This performs the offset calibration for the current offset of the board. It takes approximately 35 seconds to complete.

It is expected that no current is flowing through the sense resistor while performing this calibration step. Remove load and short PACK– to LOAD–.

Press the “Calibrate” button.

Remember to calibrate board offset after coulomb counter calibration.

#### **8.6 Current Calibration**

- Connect a load to LOAD– and LOAD+ that draws approximately 1 A, or connect a current source to PACK+ and Cell+. Ensure that the Measured Current reported is negative, or else reverse the connections.
- Measure the current with a calibrated meter, and type the value into Enter measured Current using (–) for current in discharge direction.
- Press the “Calibrate” button.
- Disconnect or stop the load current after calibration.

## 9 Firmware Screen

Firmware screen is used to save or program a complete flash image from or to the gauge. This is done using a .senc file, which contains the instruction flash image (firmware) and the data flash image. (Figure 10) The bq27741EVM may or may not be shipped with the latest firmware version (currently bq27741-G1 v1.05).

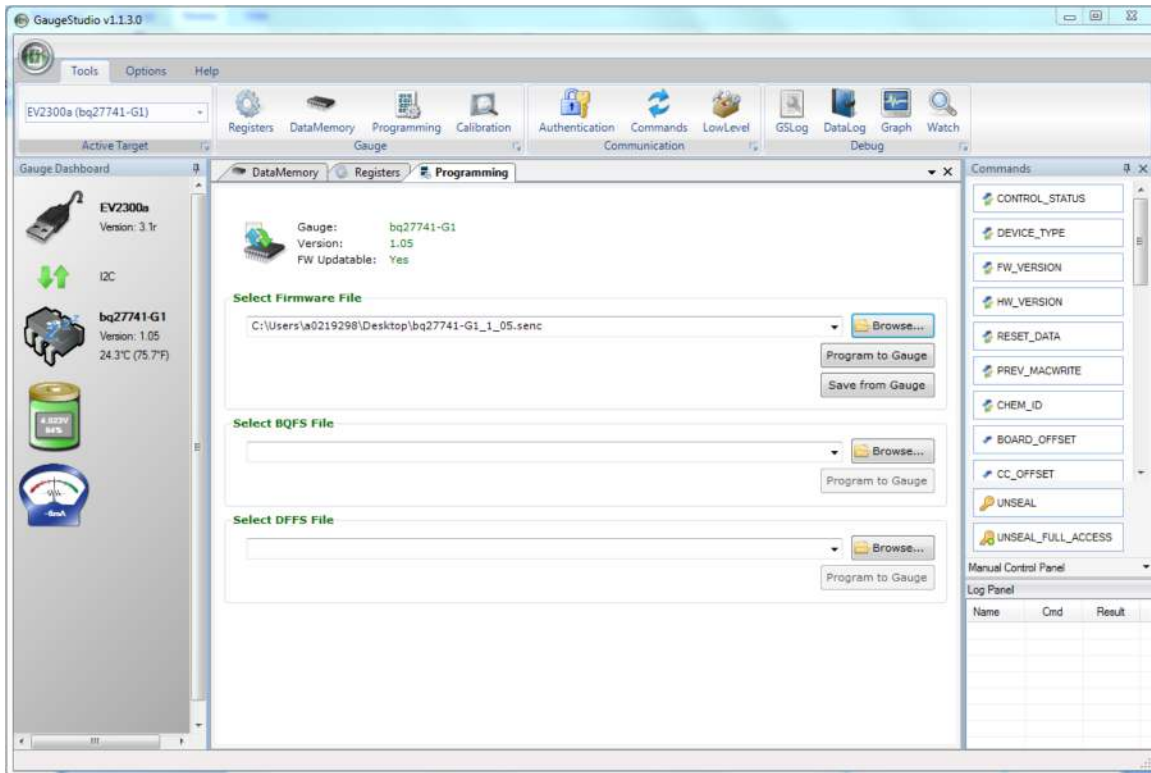

Figure 10. Firmware Screen



## 10 Preparing the Mass Production File

BqCONFIG is a tool which allows user to configure the gauge. It is based on Q&A and can help user to generate mass production files step by step.

Download the bqCONFIG from the bq27741 tool folder and install. Run GaugeStudio from the Start → Programs → Texas Instruments → bqCONFIG menu sequence. The main GaugeStudio window (Figure 11) appears.

All sections of preparing the mass production files are shown as a tools panel at the top.

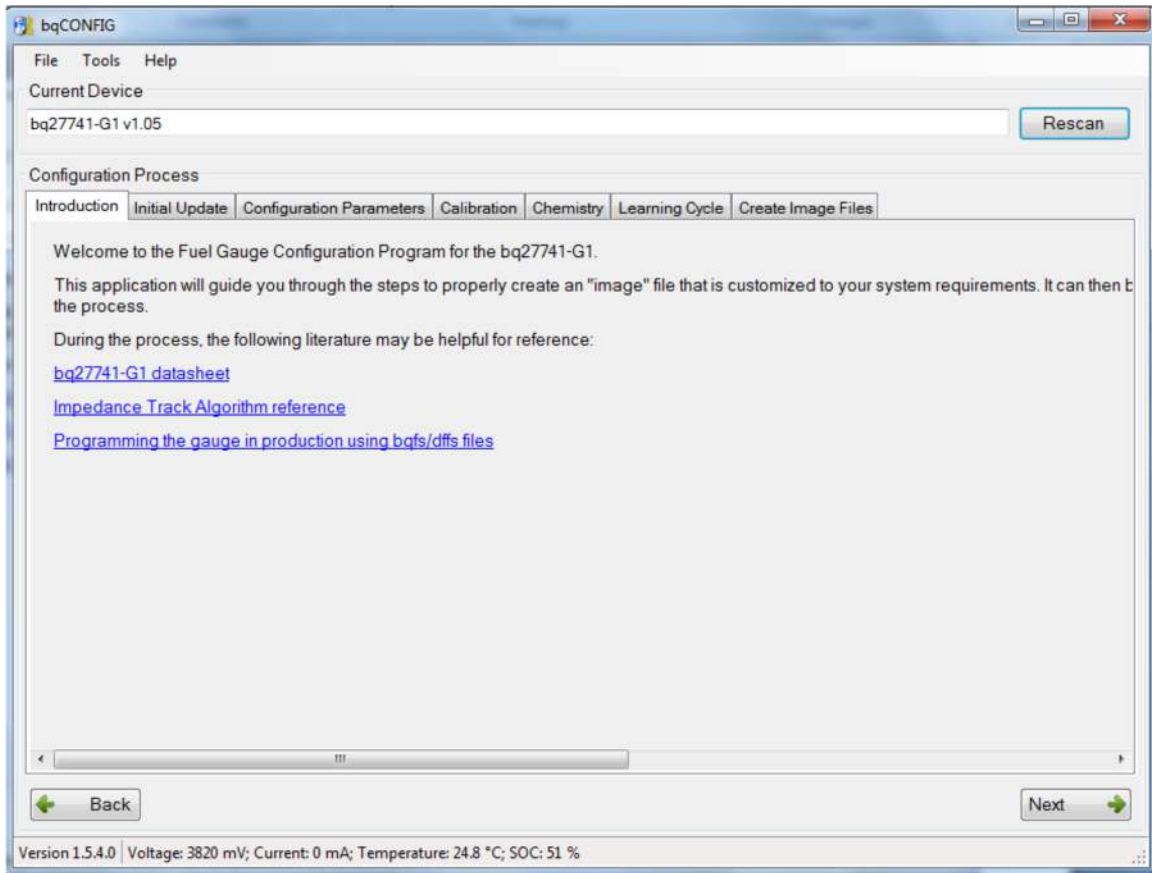

**Figure 11. bqCONFIG Screen**

### 10.1 Initial Update and Configuration Parameters

Initial Update section can initialize BQ27741 with an existing configuration. It is recommended to update a new version default firmware for a new project. Download the .senc file from the bq27741 tool folder and use “Tools→ Update Device Firmware” menu to program a .senc file into the EVM.

Configuration Parameters section allows user to set appropriate parameters for the gauge. All the settings must be programmed based on the cell characteristics, the end-system and charger requirements. Remember the bqCONFIG has two screens in this section (Figure 12), user must check both System Characteristics and Gauging Characteristics before clicking the “Save to Gauge” button.

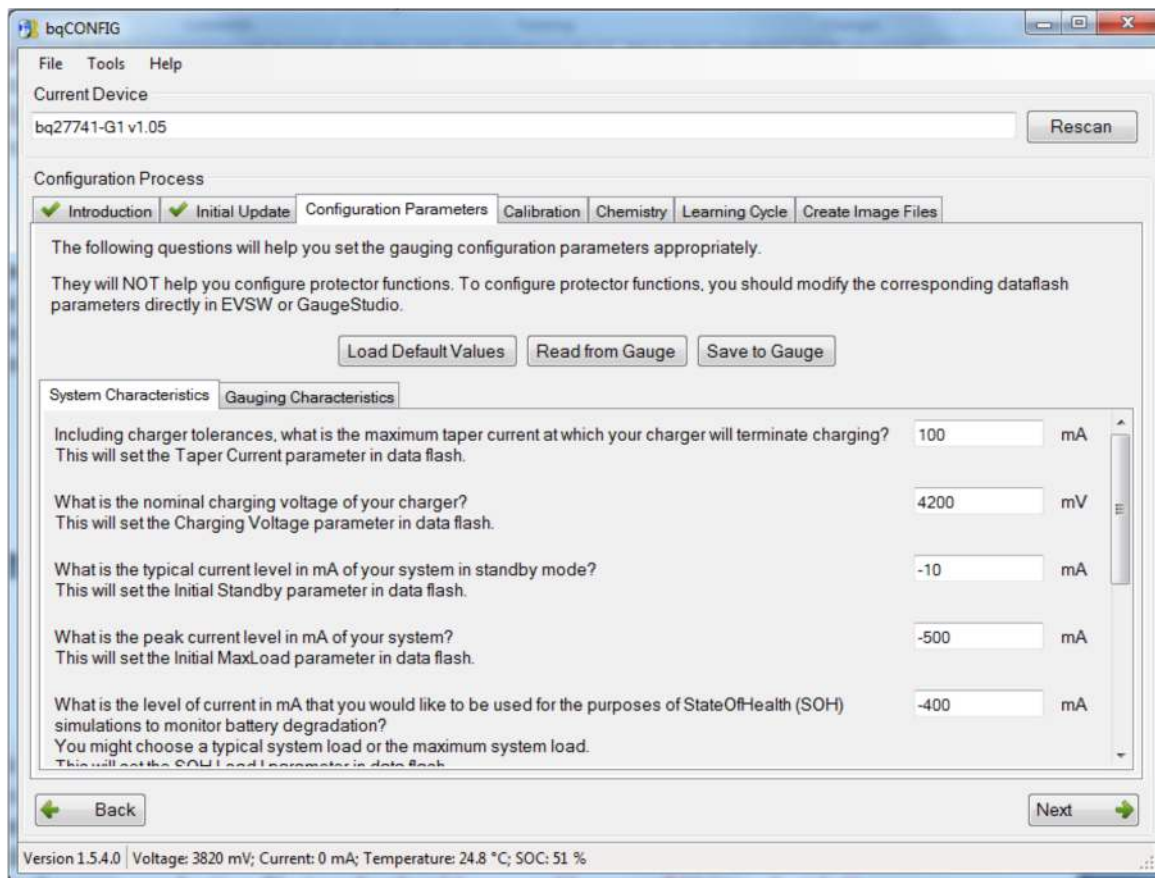
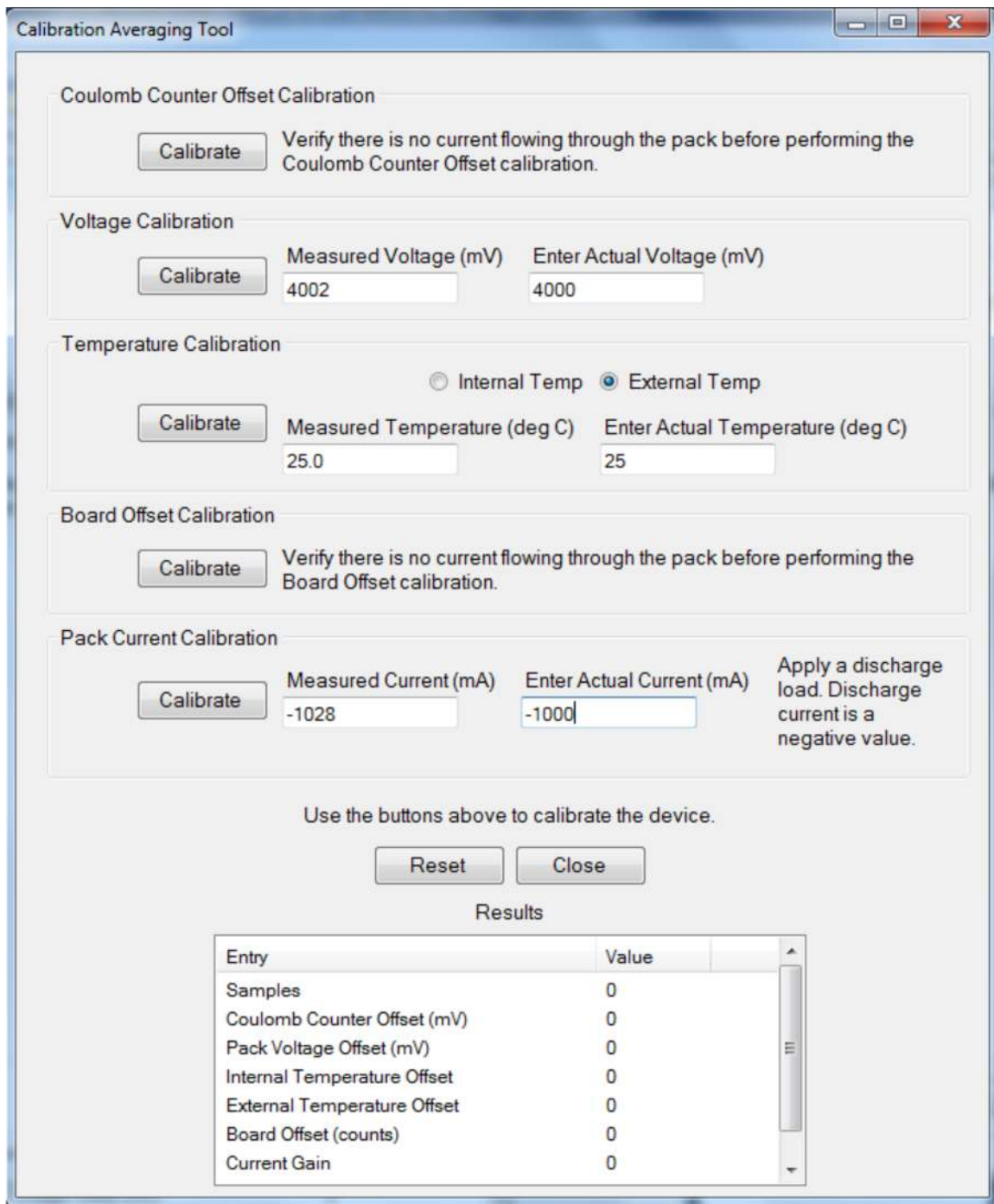

Figure 12. Configuration Parameters Screen

## 10.2 Calibration

Ensure calibration is finished before chemistry test and learning cycle. Calibration section can be finished in the GaugeStudio. However, the bqCONFIG has a Calibration Averaging Tool (Figure 13).

This tool can generate an average calibration value to be used in mass production instead of individually calibrating each board. User may calibrate 20 boards or more to have a sufficient sample size and include the average result of the calibration into the mass production file. This tool can be accessed through the Tools menu. It keeps track of the calibration values for each board and determines the average value to be included in the mass production file.



**Figure 13. Calibration Averaging Tool Screen**

### 10.3 Chemistry

This section allows user to select and program the chemistry to match specific cell. TI provides a lot of chemID which contains cell profile to match different cells.

1. Start GaugeStudio or use other equipment to log time, voltage, current, and temperature. Voltage must be measured with better than 1-mV error.
2. Charge cell to the manufacturer specified voltage, until taper current reaches C/100.
3. Wait 2 hrs
4. Discharge at C/10 rate to manufacturer specified termination voltage (use 3 V if unknown)
5. Wait 5 hrs
6. Use chemselect\_cont.mcd worksheet to find chemical ID
7. Select the correct chemical ID in bqCONFIG and clicking Update Chemistry button.

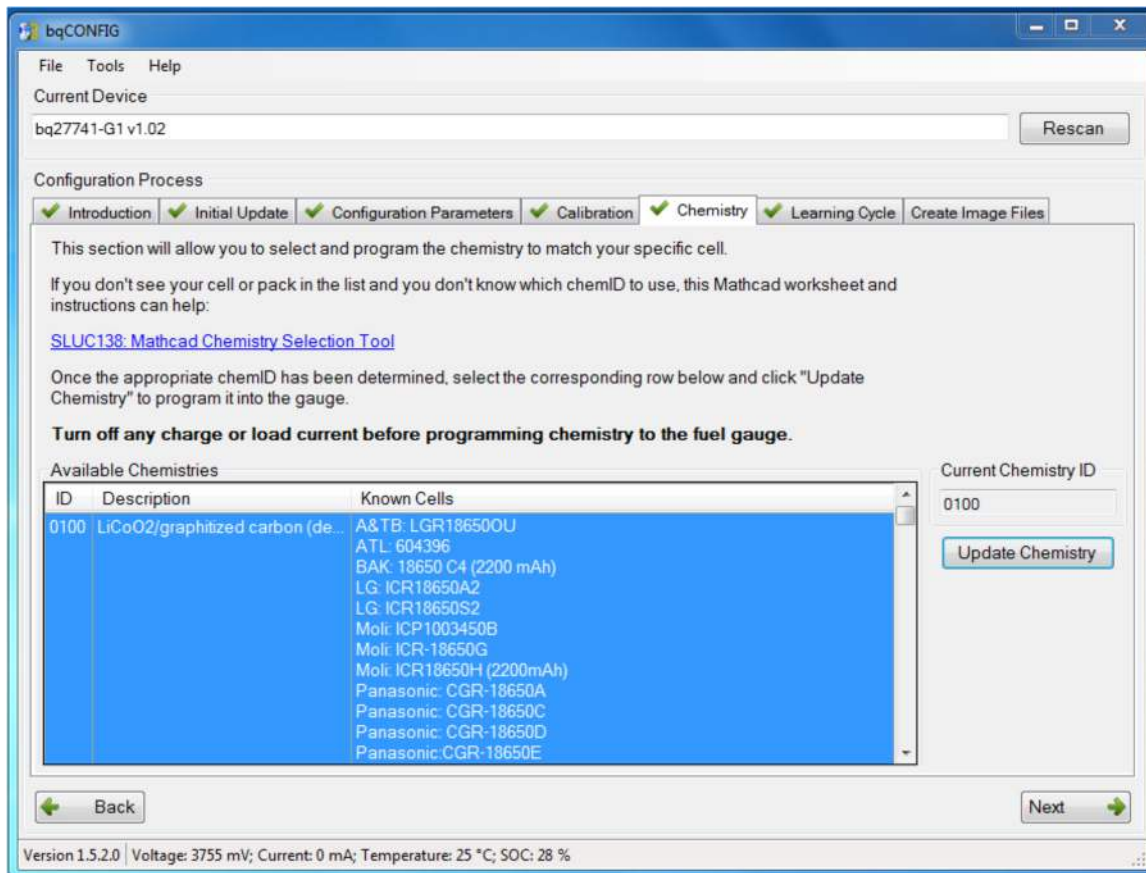

Figure 14. Chemistry Screen

## 10.4 Learning Cycle

Learning Cycle section (Figure 15) shows the information about how to do a learning cycle. After learning cycle, the gauge will update the capacity and the impedance. The learning cycle need a fully charge and discharge cycle to finish. For detailed instructions on how to perform a learning cycle and troubleshoot common issues, please refer to [SLUA587](#).

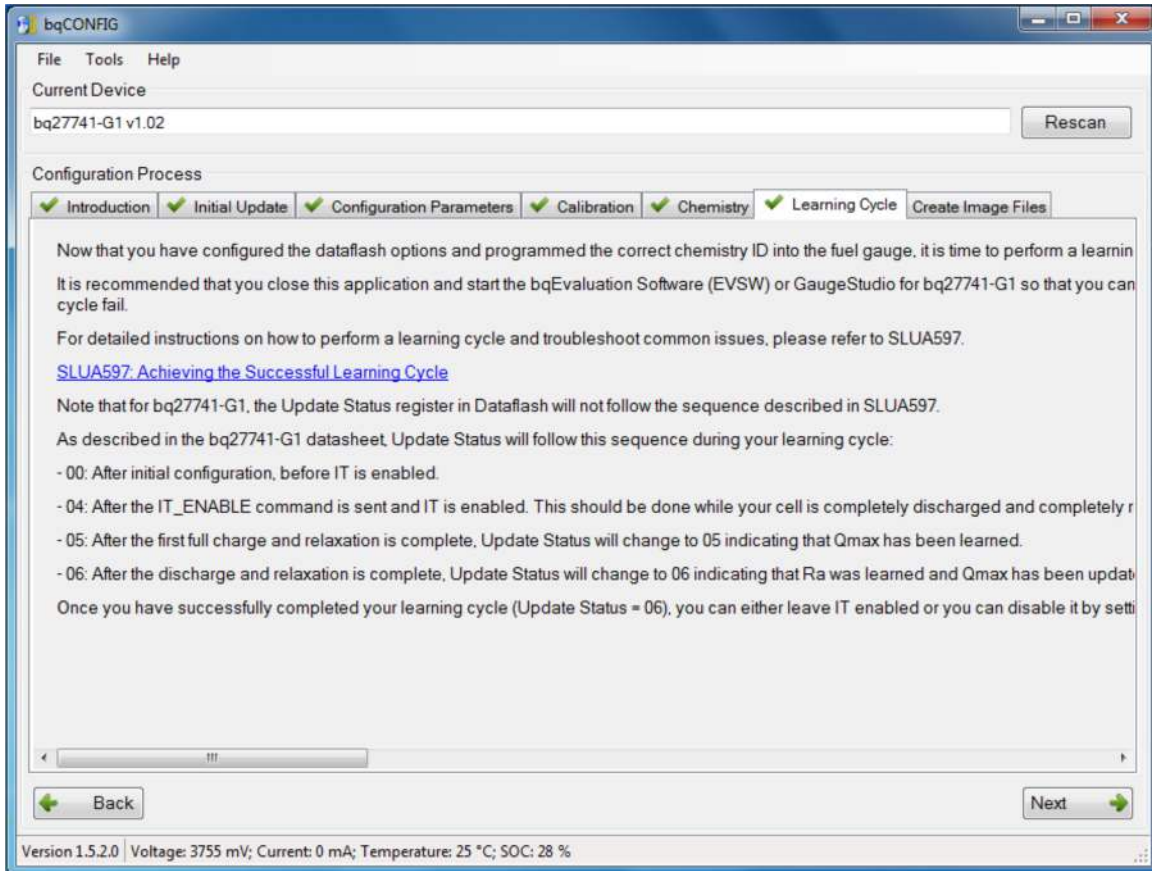

Figure 15. Learning Cycle Screen

## 10.5 Create Image Files

This section (Figure 16) allows user to export the image files for mass production. Please check every section before create image files has not problems. After creating image files, the details of how to update image files at production, please see [SLUA541](#), *Updating bq275xx Firmware at Production*.

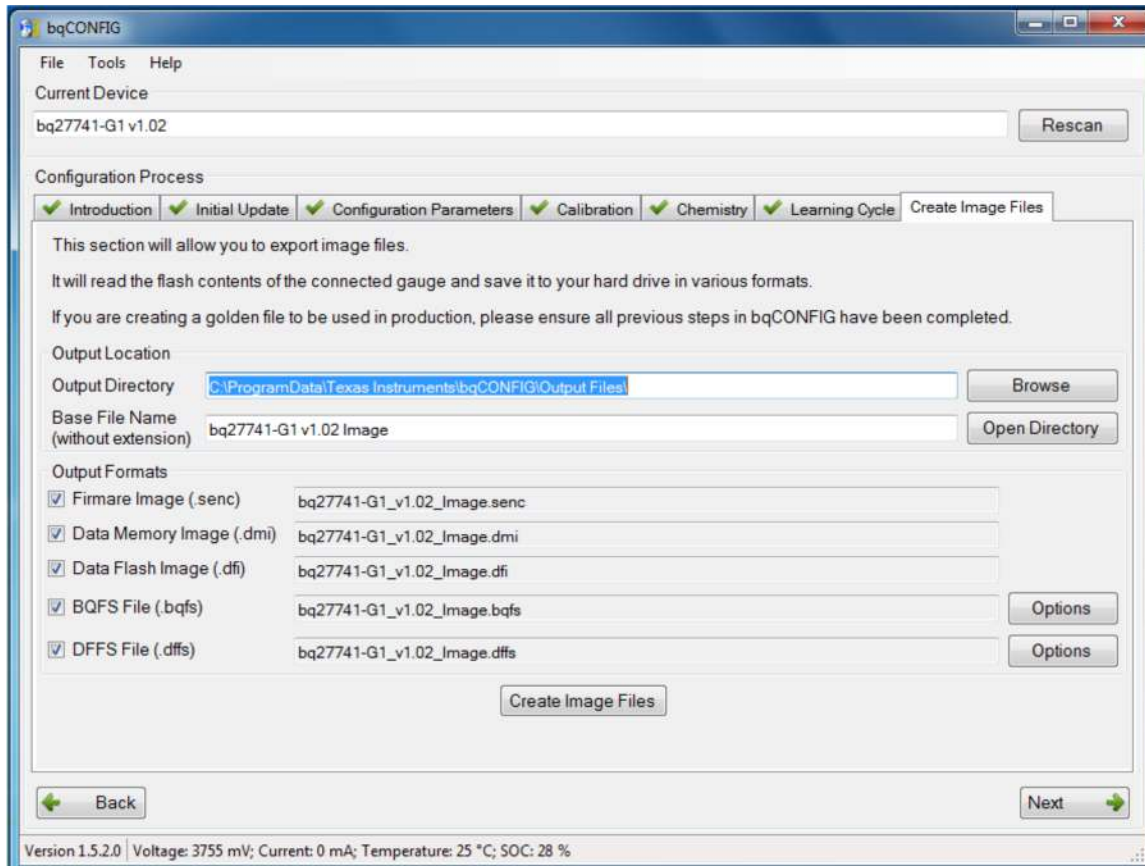

Figure 16. Create Image Files Screen

## 11 Send HDQ Screen

To configure a bq27741 into HDQ mode, navigate to the *Send HDQ* screen. It is possible that all the screen options on the left are not visible depending on screen resolution. If needed scroll within the left menu to access the *Send HDQ* link. Click on the "Change comm to HDQ8" button while having the bq27741 connected to the EV2300 via I<sup>2</sup>C. Clicking on the button causes a message to appear indicating that the process is not reversible and to confirm if the actions are desired. Also, it explains what to do once the HDQ mode has been activated.

Once converting the bq27741 into HDQ mode, it is required that you connect the HDQ terminal of the EV2300 with the HDQ connector (J4) of the bq27741 EVM, then restart the EVSW, and select the "bq27741HDQR1" with the proper firmware version from the list of supported devices within the EVSW.

## 12 Related Documentation From Texas Instruments

To obtain a copy of any of the following TI documents, call the Texas Instruments Literature Response Center at (800) 477-8924 or the Product Information Center (PIC) at (972) 644-5580. When ordering, identify this document by its title and literature number. Updated documents also can be obtained through the TI Web site at [www.ti.com](http://www.ti.com).

1. *bq27741-G1, Single Cell Li-Ion Battery Fuel Gauge with Integrated Protection Data Sheet* ([SLUSBF2](#))
2. *bq27741-G1, Pack-Side Impedance Track™ Battery Fuel Gauge With Integrated Protector and LDO User's Guide* ([SLUUA3](#))

## EVALUATION BOARD/KIT IMPORTANT NOTICE

Texas Instruments (TI) provides the enclosed product(s) under the following conditions:

This evaluation board/kit is intended for use for **ENGINEERING DEVELOPMENT, DEMONSTRATION, OR EVALUATION PURPOSES ONLY** and is not considered by TI to be a finished end-product fit for general consumer use. Persons handling the product(s) must have electronics training and observe good engineering practice standards. As such, the goods being provided are not intended to be complete in terms of required design-, marketing-, and/or manufacturing-related protective considerations, including product safety and environmental measures typically found in end products that incorporate such semiconductor components or circuit boards. This evaluation board/kit does not fall within the scope of the European Union directives regarding electromagnetic compatibility, restricted substances (RoHS), recycling (WEEE), FCC, CE or UL, and therefore may not meet the technical requirements of these directives or other related directives.

Should this evaluation board/kit not meet the specifications indicated in the User's Guide, the board/kit may be returned within 30 days from the date of delivery for a full refund. **THE FOREGOING WARRANTY IS THE EXCLUSIVE WARRANTY MADE BY SELLER TO BUYER AND IS IN LIEU OF ALL OTHER WARRANTIES, EXPRESSED, IMPLIED, OR STATUTORY, INCLUDING ANY WARRANTY OF MERCHANTABILITY OR FITNESS FOR ANY PARTICULAR PURPOSE.**

The user assumes all responsibility and liability for proper and safe handling of the goods. Further, the user indemnifies TI from all claims arising from the handling or use of the goods. Due to the open construction of the product, it is the user's responsibility to take any and all appropriate precautions with regard to electrostatic discharge.

**EXCEPT TO THE EXTENT OF THE INDEMNITY SET FORTH ABOVE, NEITHER PARTY SHALL BE LIABLE TO THE OTHER FOR ANY INDIRECT, SPECIAL, INCIDENTAL, OR CONSEQUENTIAL DAMAGES.**

TI currently deals with a variety of customers for products, and therefore our arrangement with the user **is not exclusive.**

TI assumes **no liability for applications assistance, customer product design, software performance, or infringement of patents or services described herein.**

Please read the User's Guide and, specifically, the Warnings and Restrictions notice in the User's Guide prior to handling the product. This notice contains important safety information about temperatures and voltages. For additional information on TI's environmental and/or safety programs, please contact the TI application engineer or visit [www.ti.com/esh](http://www.ti.com/esh).

No license is granted under any patent right or other intellectual property right of TI covering or relating to any machine, process, or combination in which such TI products or services might be or are used.

### FCC Warning

This evaluation board/kit is intended for use for **ENGINEERING DEVELOPMENT, DEMONSTRATION, OR EVALUATION PURPOSES ONLY** and is not considered by TI to be a finished end-product fit for general consumer use. It generates, uses, and can radiate radio frequency energy and has not been tested for compliance with the limits of computing devices pursuant to part 15 of FCC rules, which are designed to provide reasonable protection against radio frequency interference. Operation of this equipment in other environments may cause interference with radio communications, in which case the user at his own expense will be required to take whatever measures may be required to correct this interference.

### EVM WARNINGS AND RESTRICTIONS

It is important to operate this EVM within the input voltage range of 6 V to 25 V and the output voltage range of 0 V to 16.4 V.

Exceeding the specified input range may cause unexpected operation and/or irreversible damage to the EVM. If there are questions concerning the input range, please contact a TI field representative prior to connecting the input power.

Applying loads outside of the specified output range may result in unintended operation and/or possible permanent damage to the EVM. Please consult the EVM User's Guide prior to connecting any load to the EVM output. If there is uncertainty as to the load specification, please contact a TI field representative.

During normal operation, some circuit components may have case temperatures greater than 60°C. The EVM is designed to operate properly with certain components above 60°C as long as the input and output ranges are maintained. These components include but are not limited to linear regulators, switching transistors, pass transistors, and current sense resistors. These types of devices can be identified using the EVM schematic located in the EVM User's Guide. When placing measurement probes near these devices during operation, please be aware that these devices may be very warm to the touch.

Mailing Address: Texas Instruments, Post Office Box 655303, Dallas, Texas 75265  
Copyright © 2013, Texas Instruments Incorporated



## IMPORTANT NOTICE

Texas Instruments Incorporated and its subsidiaries (TI) reserve the right to make corrections, enhancements, improvements and other changes to its semiconductor products and services per JESD46, latest issue, and to discontinue any product or service per JESD48, latest issue. Buyers should obtain the latest relevant information before placing orders and should verify that such information is current and complete. All semiconductor products (also referred to herein as "components") are sold subject to TI's terms and conditions of sale supplied at the time of order acknowledgment.

TI warrants performance of its components to the specifications applicable at the time of sale, in accordance with the warranty in TI's terms and conditions of sale of semiconductor products. Testing and other quality control techniques are used to the extent TI deems necessary to support this warranty. Except where mandated by applicable law, testing of all parameters of each component is not necessarily performed.

TI assumes no liability for applications assistance or the design of Buyers' products. Buyers are responsible for their products and applications using TI components. To minimize the risks associated with Buyers' products and applications, Buyers should provide adequate design and operating safeguards.

TI does not warrant or represent that any license, either express or implied, is granted under any patent right, copyright, mask work right, or other intellectual property right relating to any combination, machine, or process in which TI components or services are used. Information published by TI regarding third-party products or services does not constitute a license to use such products or services or a warranty or endorsement thereof. Use of such information may require a license from a third party under the patents or other intellectual property of the third party, or a license from TI under the patents or other intellectual property of TI.

Reproduction of significant portions of TI information in TI data books or data sheets is permissible only if reproduction is without alteration and is accompanied by all associated warranties, conditions, limitations, and notices. TI is not responsible or liable for such altered documentation. Information of third parties may be subject to additional restrictions.

Resale of TI components or services with statements different from or beyond the parameters stated by TI for that component or service voids all express and any implied warranties for the associated TI component or service and is an unfair and deceptive business practice. TI is not responsible or liable for any such statements.

Buyer acknowledges and agrees that it is solely responsible for compliance with all legal, regulatory and safety-related requirements concerning its products, and any use of TI components in its applications, notwithstanding any applications-related information or support that may be provided by TI. Buyer represents and agrees that it has all the necessary expertise to create and implement safeguards which anticipate dangerous consequences of failures, monitor failures and their consequences, lessen the likelihood of failures that might cause harm and take appropriate remedial actions. Buyer will fully indemnify TI and its representatives against any damages arising out of the use of any TI components in safety-critical applications.

In some cases, TI components may be promoted specifically to facilitate safety-related applications. With such components, TI's goal is to help enable customers to design and create their own end-product solutions that meet applicable functional safety standards and requirements. Nonetheless, such components are subject to these terms.

No TI components are authorized for use in FDA Class III (or similar life-critical medical equipment) unless authorized officers of the parties have executed a special agreement specifically governing such use.

Only those TI components which TI has specifically designated as military grade or "enhanced plastic" are designed and intended for use in military/aerospace applications or environments. Buyer acknowledges and agrees that any military or aerospace use of TI components which have **not** been so designated is solely at the Buyer's risk, and that Buyer is solely responsible for compliance with all legal and regulatory requirements in connection with such use.

TI has specifically designated certain components as meeting ISO/TS16949 requirements, mainly for automotive use. In any case of use of non-designated products, TI will not be responsible for any failure to meet ISO/TS16949.

### Products

Audio	<a href="http://www.ti.com/audio">www.ti.com/audio</a>
Amplifiers	<a href="http://amplifier.ti.com">amplifier.ti.com</a>
Data Converters	<a href="http://dataconverter.ti.com">dataconverter.ti.com</a>
DLP® Products	<a href="http://www.dlp.com">www.dlp.com</a>
DSP	<a href="http://dsp.ti.com">dsp.ti.com</a>
Clocks and Timers	<a href="http://www.ti.com/clocks">www.ti.com/clocks</a>
Interface	<a href="http://interface.ti.com">interface.ti.com</a>
Logic	<a href="http://logic.ti.com">logic.ti.com</a>
Power Mgmt	<a href="http://power.ti.com">power.ti.com</a>
Microcontrollers	<a href="http://microcontroller.ti.com">microcontroller.ti.com</a>
RFID	<a href="http://www.ti-rfid.com">www.ti-rfid.com</a>
OMAP Applications Processors	<a href="http://www.ti.com/omap">www.ti.com/omap</a>
Wireless Connectivity	<a href="http://www.ti.com/wirelessconnectivity">www.ti.com/wirelessconnectivity</a>

### Applications

Automotive and Transportation	<a href="http://www.ti.com/automotive">www.ti.com/automotive</a>
Communications and Telecom	<a href="http://www.ti.com/communications">www.ti.com/communications</a>
Computers and Peripherals	<a href="http://www.ti.com/computers">www.ti.com/computers</a>
Consumer Electronics	<a href="http://www.ti.com/consumer-apps">www.ti.com/consumer-apps</a>
Energy and Lighting	<a href="http://www.ti.com/energy">www.ti.com/energy</a>
Industrial	<a href="http://www.ti.com/industrial">www.ti.com/industrial</a>
Medical	<a href="http://www.ti.com/medical">www.ti.com/medical</a>
Security	<a href="http://www.ti.com/security">www.ti.com/security</a>
Space, Avionics and Defense	<a href="http://www.ti.com/space-avionics-defense">www.ti.com/space-avionics-defense</a>
Video and Imaging	<a href="http://www.ti.com/video">www.ti.com/video</a>

### TI E2E Community

[e2e.ti.com](http://e2e.ti.com)