



## Table of Contents

Table of Contents.....	1
Silicon revision.....	2
Description.....	2
Required Equipment.....	3
Evaluation Board Overview.....	3
Instructions.....	4
Evaluation Board Schematic.....	5
Bill of Materials.....	6
Typical Performance.....	7
Test Recommendations.....	11

## Silicon revision

The silicon presented in this User Guide is ES1.

## Description

The EN6362QI is a Power System on a Chip (Power SoC) DC to DC converter with an integrated inductor, PWM controller, MOSFETs and

compensation to provide the smallest solution size in an 8x8x3mm 56 pin QFN module.

Required Equipment

No.#	Equipment	Minimum Spec
1	DC power supply	10V/10A, adjustable
2	Electronic Load	10V/20 with dynamic load capabilities
3	DMM	-
4	Oscilloscope	-
5	Cables	>10A capability, banana terminal

Evaluation Board Overview

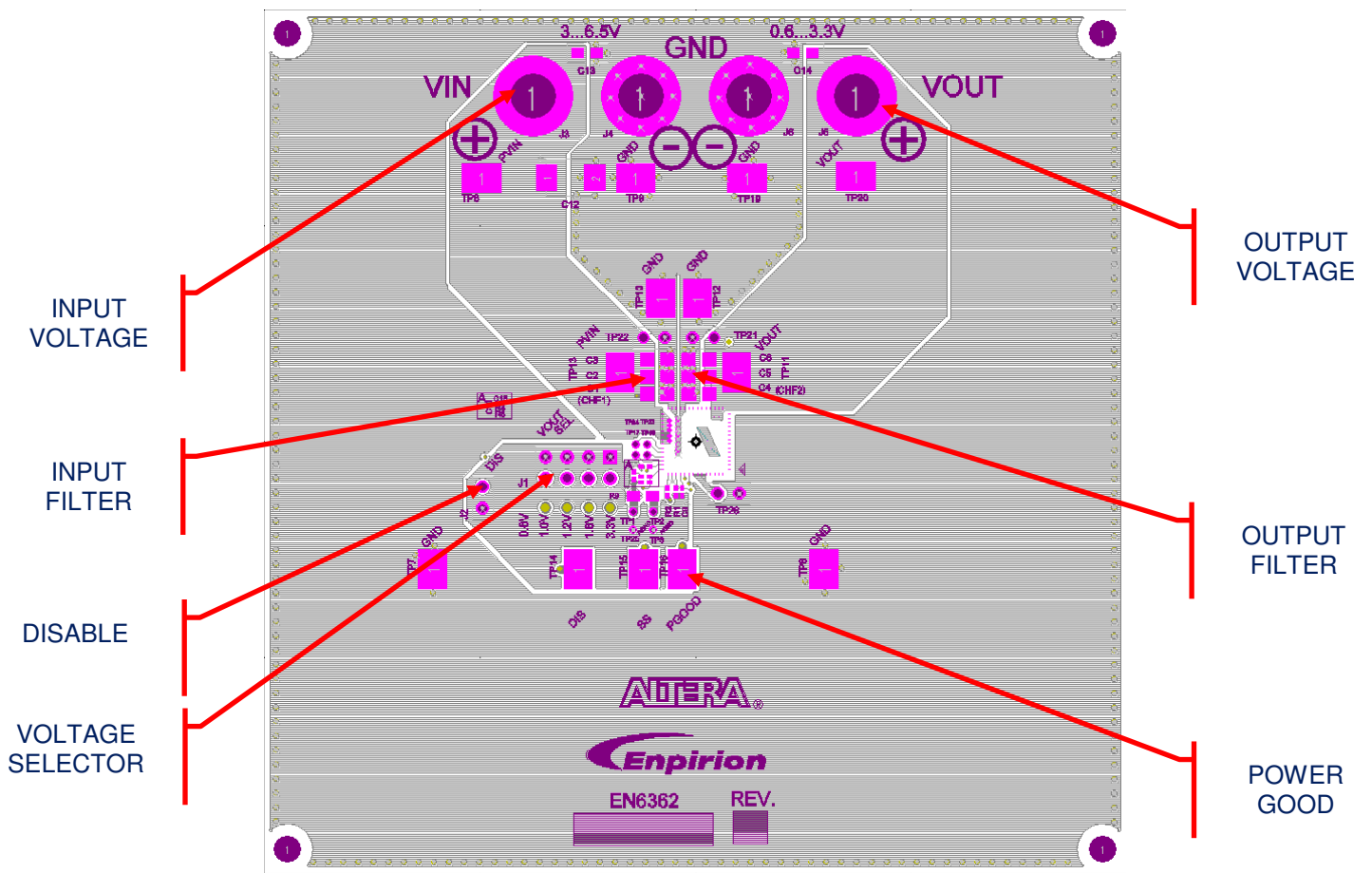

Figure 1: EN6362 Evaluation Board Illustration (Top Layer)

## Instructions



**Warning:**

***Incorrect polarity of the power supply may cause permanent damage!***



**Warning:**

***Power supply voltage above 7V may cause permanent damage!***



**Warning:**

***Do NOT hot-plug the board; the resulting overvoltage may cause permanent damage!***



### 1) Connecting the power supply

- Set the Power Supply to 5V/10A
- Connect the power supply to the board (make sure that the power supply is OFF) with two patch cables, not longer than 12 inch (30cm). Using longer wires is possible, provided that additional bulk is added to the

board and the input voltage is monitored at the board level. Please use INPUT GROUND and INPUT VOLTAGE jacks to connect the power.

- Please observe the correct polarity.

### 2) Connecting the load

- Connect the load to the OUTPUT GROUND and OUTPUT voltage with patch cables, no longer than 12 inches (30cm).
- Please observe the correct polarity.

### 3) Jumper Setting

- The board will arrive with NO jumper on the J2 and one jumper on J1, in the 1V0 position. Connecting more than one jumper on J1 will not damage the board – just drive the output voltage higher.

### 4) Power-up the board

- After all preparations above, the board should be ready to perform.

**Note:** To measure the Bode Plot of the DC-DC converter, R9 must be replaced with 50Ω, while TP1, 2 and 3 should be used to connect the probes of the phase analyzer.

Evaluation Board Schematic

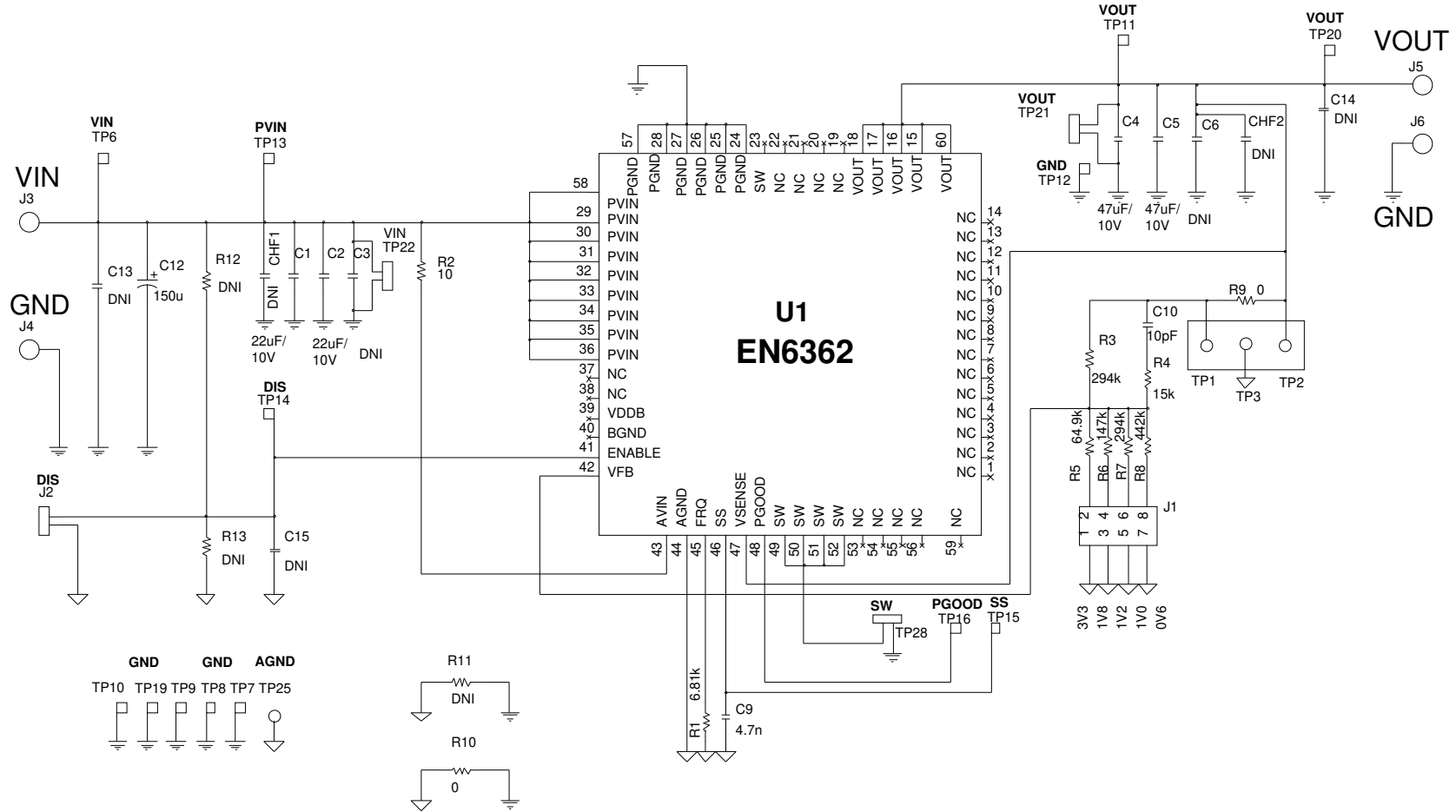

Figure 2: Evaluation Board Schematic

## Bill of Materials

Designator	Qty	Description
C1,C2	2	22 $\mu$ F/10V
C9	1	4.7nF
C10	1	10pF
C4, C5	1	47 $\mu$ F/10V
C12	1	150 $\mu$ F
R1	1	6.81k $\Omega$
R2	1	10 $\Omega$
R3,R7	2	294k $\Omega$
R4	1	15k $\Omega$
R5	1	64.9k $\Omega$
R6	1	147k $\Omega$
R8	1	442k $\Omega$
R9, R10	2	0 $\Omega$
U1	1	EN6362QI

Typical Performance

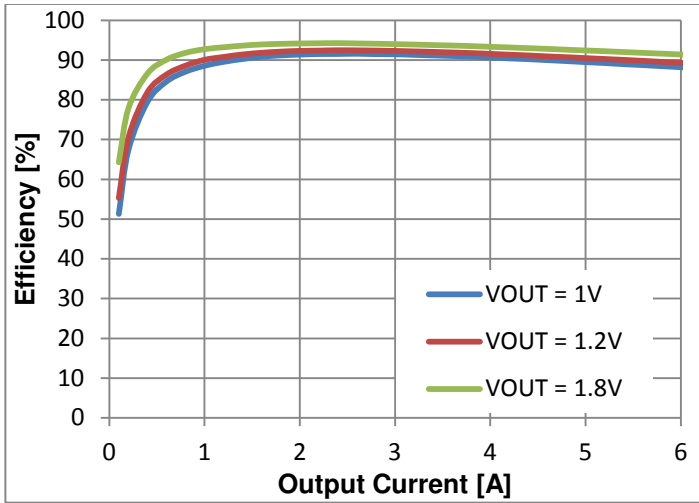

Figure 3: Efficiency –  $V_{IN} = 3.3V$

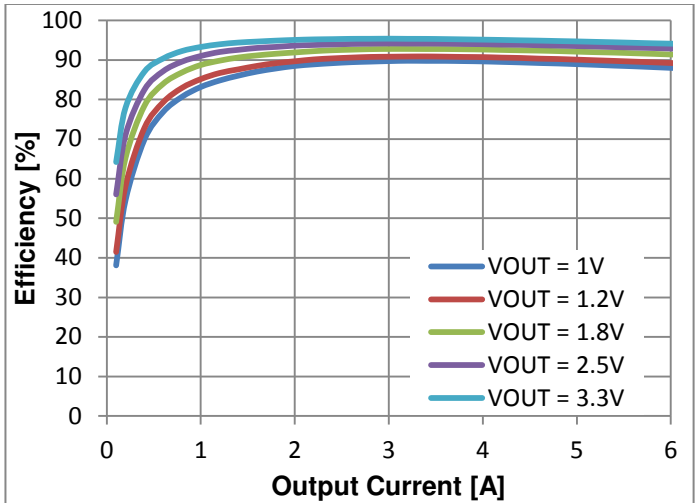

Figure 4: Efficiency –  $V_{IN} = 5V$

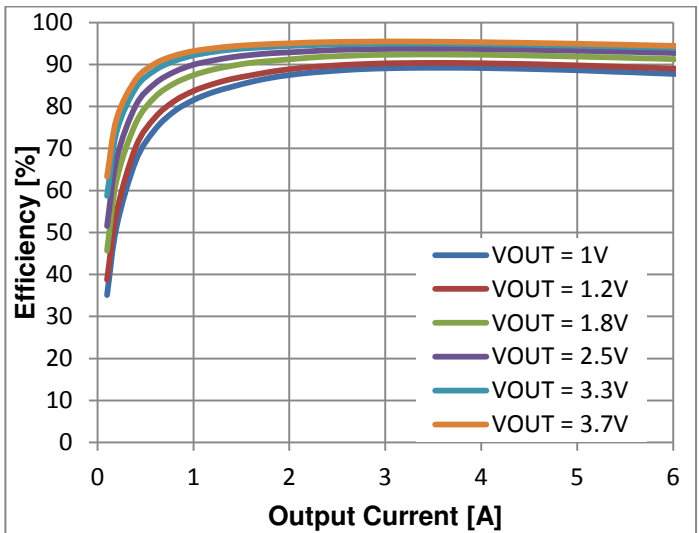

Figure 5: Efficiency –  $V_{IN} = 5.5V$

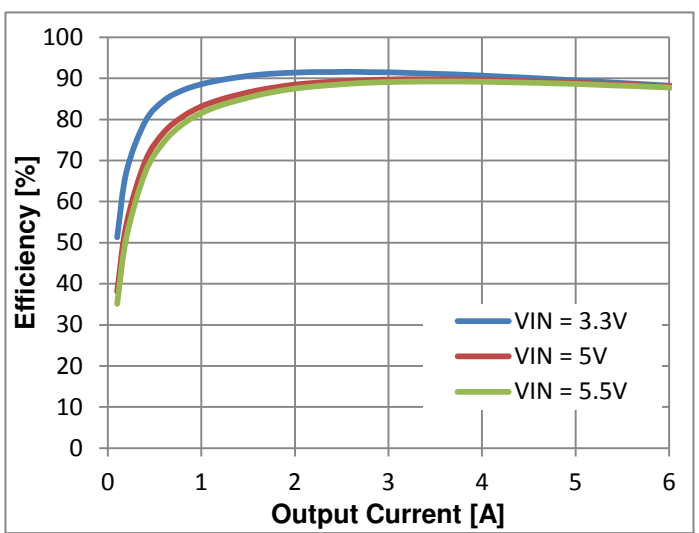

Figure 6: Efficiency –  $V_{OUT} = 1V$

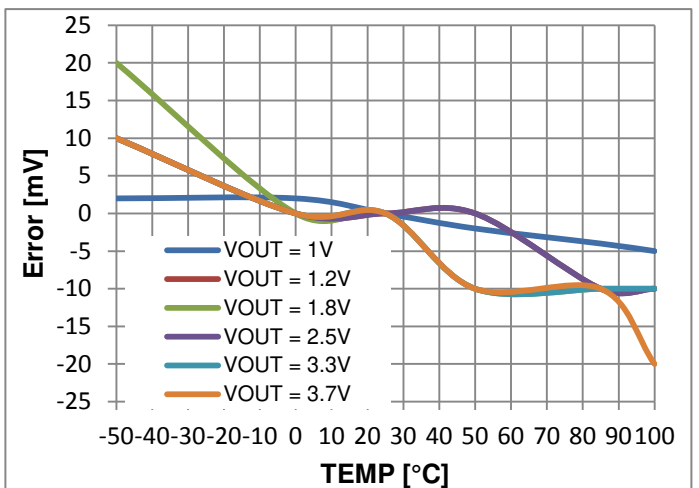

Figure 7  $V_{OUT}$  vs. Temperature (NO load)

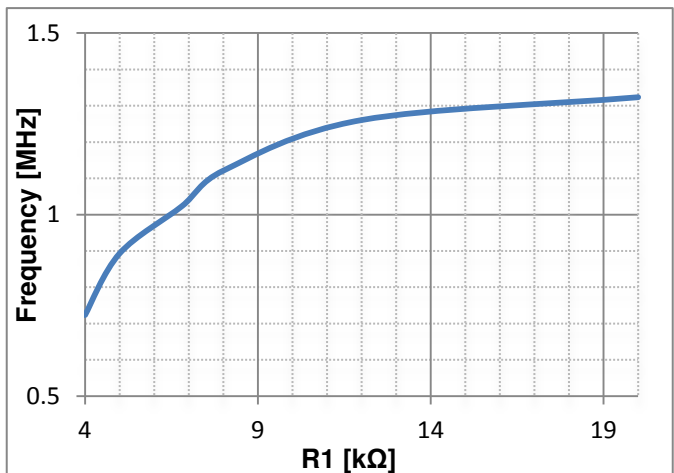

Figure 8: Frequency vs.  $R1$

Typical Performance Curves (Continued)

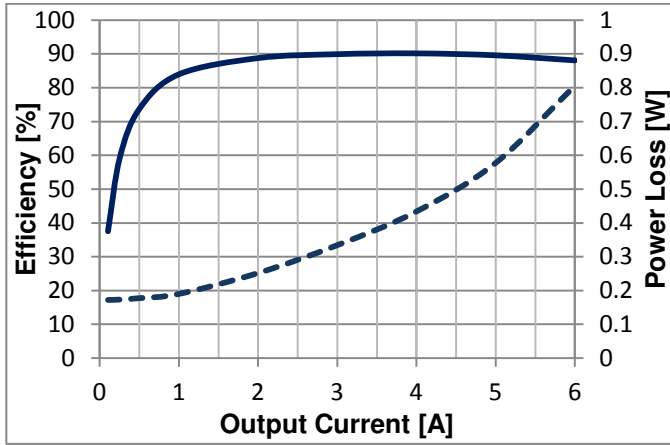

Figure 9: Efficiency for  $V_{IN} = 6V$ ,  $V_{OUT} = 1V$ ,  $f = 0.7MHz$

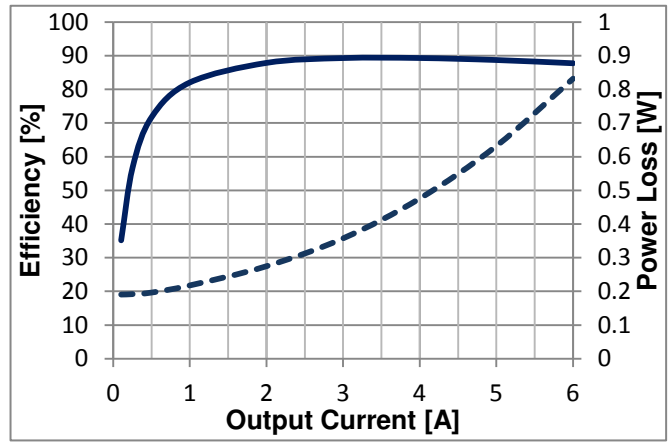

Figure 10: Efficiency for  $V_{IN} = 6V$ ,  $V_{OUT} = 1V$ ,  $f = 1MHz$

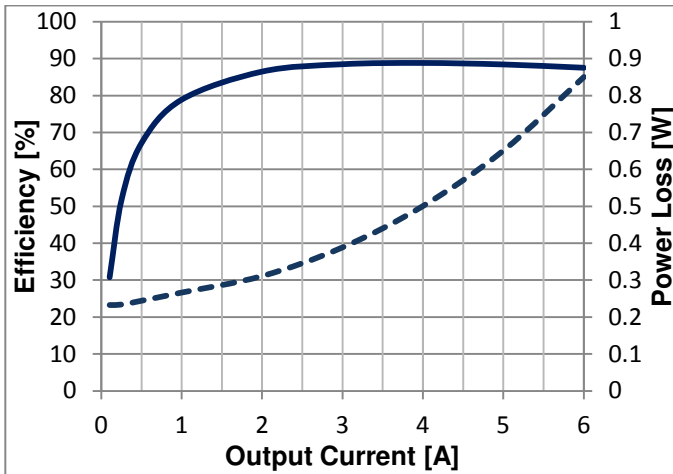

Figure 11: Efficiency for  $V_{IN} = 6V$ ,  $V_{OUT} = 1V$ ,  $f = 1.4MHz$

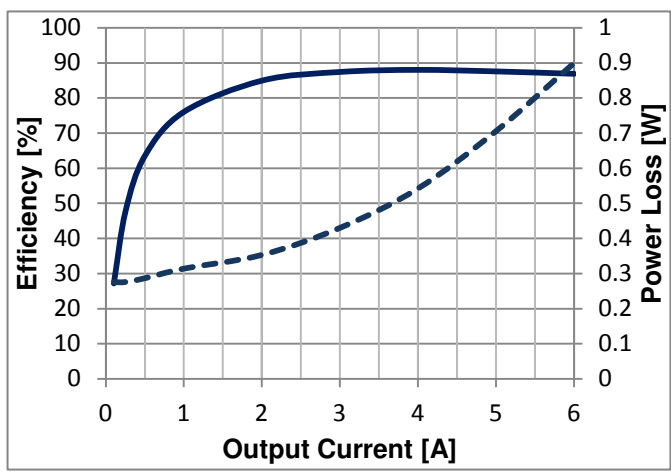

Figure 12: Efficiency for  $V_{IN} = 6V$ ,  $V_{OUT} = 1V$ ,  $f = 1.7MHz$



Typical Performance Characteristics



Figure 13: Output ripple  $V_{IN} = 5V$ ,  $V_{OUT} = 1V$



Figure 14: Output ripple  $V_{IN} = 5V$ ,  $V_{OUT} = 1.8V$



Figure 15: Output ripple  $V_{IN} = 5V$ ,  $V_{OUT} = 3.3V$

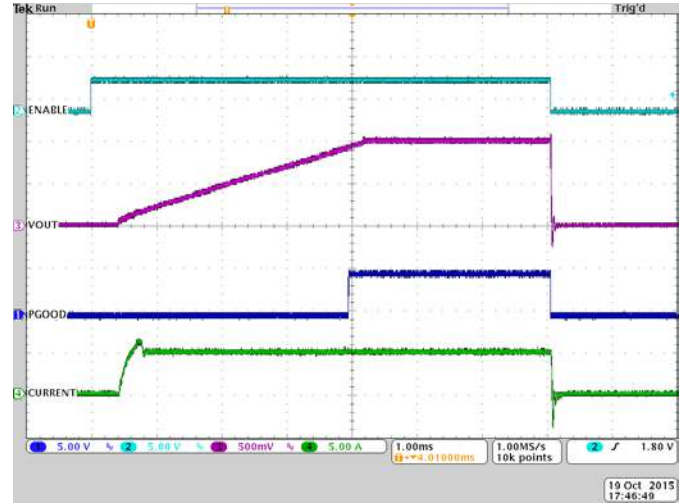

Figure 16: Startup  $V_{IN} = 5V$ ,  $V_{OUT} = 1V$ ,  $I_L = 6A$

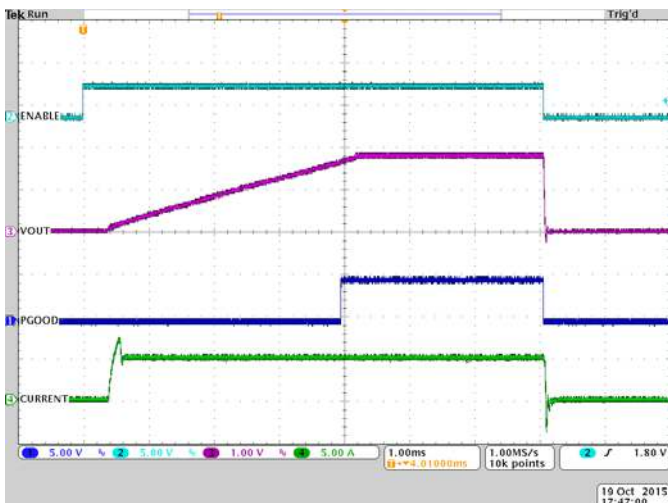

Figure 17: Startup  $V_{IN} = 5V$ ,  $V_{OUT} = 1.8V$ ,  $I_{LOAD} = 6A$

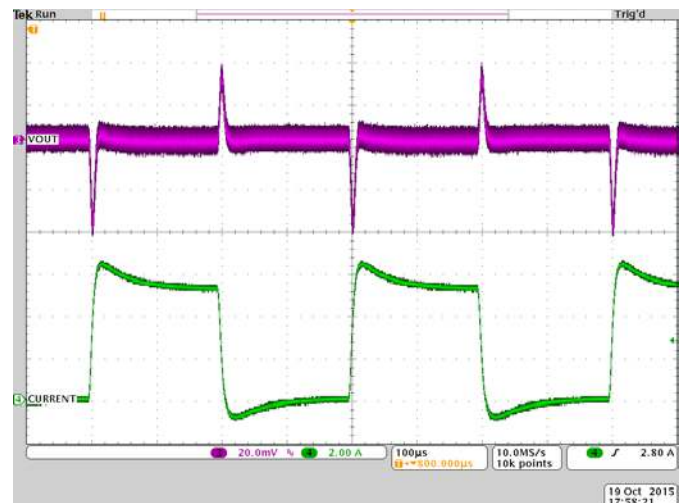

Figure 18: 0/6A load transient

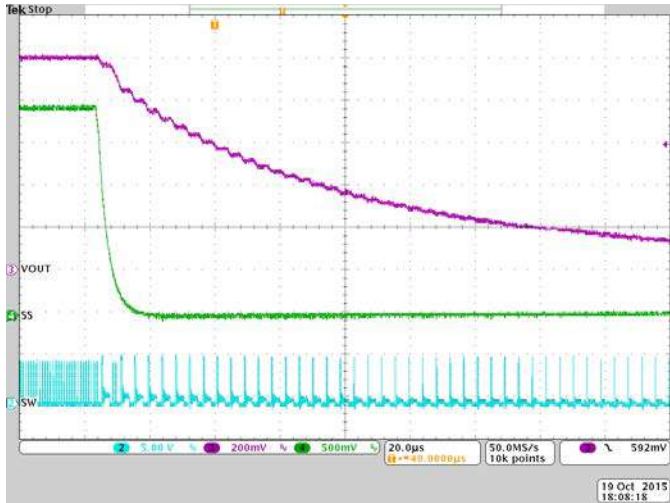

Figure 19: RCL protection activated by forcing the SS pin

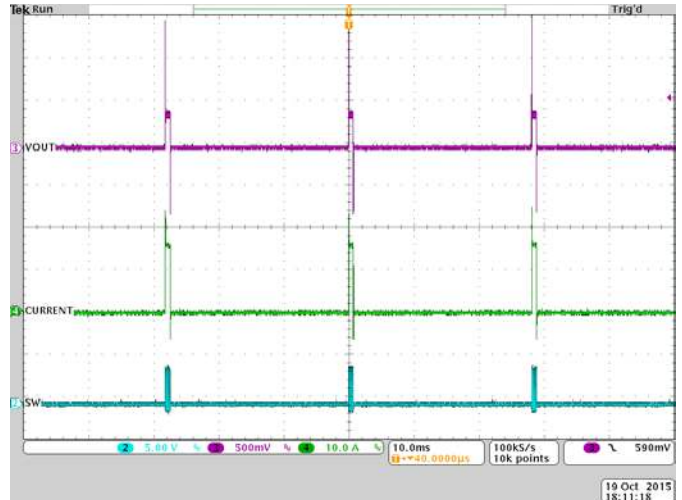
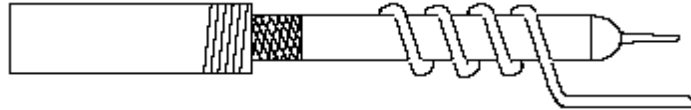

Figure 20: Hiccup mode during short-circuit protection

## Test Recommendations

In order to get accurate measurements for sensitive nodes, small loop area (small antennae) are recommended. Besides the built-in low inductance of the ground, the small loop area will collect less EMI than the standard oscilloscope ground cables.



The EVAL board provides **3 test-points suitable** for connecting the oscilloscope probe as described above; these are:

- **TP28** – for the Switch Node (SW)
- **TP21** – for the Output Voltage ( $V_{OUT}$ )
- **TP22** – for the Input Voltage ( $V_{IN}$ ).

## Contact Information

Altera Corporation  
101 Innovation Drive  
San Jose, CA 95134  
Phone: 408-544-7000  
[www.altera.com](http://www.altera.com)

© 2015 Altera Corporation—Confidential. All rights reserved. ALTERA, ARRIA, CYCLONE, ENPIRION, HARDCOPY, MAX, MEGACORE, NIOS, QUARTUS and STRATIX words and logos are trademarks of Altera Corporation and registered in the U.S. Patent and Trademark Office and in other countries. All other words and logos identified as trademarks or service marks are the property of their respective holders as described at [www.altera.com/common/legal.html](http://www.altera.com/common/legal.html). Altera warrants performance of its semiconductor products to current specifications in accordance with Altera's standard warranty, but reserves the right to make changes to any products and services at any time without notice. Altera assumes no responsibility or liability arising out of the application or use of any information, product, or service described herein except as expressly agreed to in writing by Altera. Altera customers are advised to obtain the latest version of device specifications before relying on any published information and before placing orders for products or services.