

# PTSM 0,5/ 6-PL-2,5 BK - Printed-circuit board connector



1709447

<https://www.phoenixcontact.com/us/products/1709447>

Please be informed that the data shown in this PDF document is generated from our online catalog. Please find the complete data in the user documentation. Our general terms of use for downloads are valid.



PCB connector, nominal cross section: 0.5 mm<sup>2</sup>, color: black, nominal current: 6 A, rated voltage (III/2): 160 V, contact surface: Tin, contact connection type: Socket, number of potentials: 6, number of rows: 1, number of positions: 6, number of connections: 6, product range: PTSM 0,5/..-PL, pitch: 2.5 mm, connection method: Push-in spring connection, conductor/PCB connection direction: 0 °, plug-in system: COMBICON PTSM, locking: Snap-in locking, mounting: Self-locking flange, type of packaging: packed in cardboard

## Your advantages

- Time saving push-in connection, tools not required
- Defined contact force ensures that contact remains stable over the long term
- High current carrying capacity of 6 A in very compact dimensions
- Intuitive locking mechanism prevents accidental disconnection

## Commercial data

Item number	1709447
Packing unit	1 pc
Minimum order quantity	100 pc
Sales key	AA01
Product key	AAAFPF
GTIN	4055626130859
Weight per piece (including packing)	1.888 g
Weight per piece (excluding packing)	1.888 g
Customs tariff number	85366990
Country of origin	PL

# PTSM 0,5/ 6-PL-2,5 BK - Printed-circuit board connector



1709447

<https://www.phoenixcontact.com/us/products/1709447>

## Technical data

### Product properties

Type	Standard
Product line	COMBICON Connectors XS
Product type	PCB connector
Product family	PTSM 0,5/...-PL
Number of positions	6
Pitch	2.5 mm
Number of connections	6
Number of rows	1
Number of potentials	6

### Electrical properties

Nominal current $I_N$	6 A
Nominal voltage $U_N$	160 V
Degree of pollution	3
Contact resistance	3 m $\Omega$
Rated voltage (III/3)	100 V
Rated surge voltage (III/3)	2.5 kV
Rated voltage (III/2)	160 V
Rated surge voltage (III/2)	2.5 kV
Rated voltage (II/2)	320 V
Rated surge voltage (II/2)	2.5 kV

### Connection data

#### Connection technology

Type	Standard
Connector system	COMBICON PTSM
Nominal cross section	0.5 mm <sup>2</sup>
Contact connection type	Socket

#### Interlock

Locking type	Snap-in locking
Mounting flange	Self-locking flange

#### Conductor connection

Connection method	Push-in spring connection
Conductor/PCB connection direction	0 °
Conductor cross section rigid	0.14 mm <sup>2</sup> ... 0.5 mm <sup>2</sup>
Conductor cross section flexible	0.2 mm <sup>2</sup> ... 0.5 mm <sup>2</sup> (up to 0.75 mm <sup>2</sup> supported, with a stripping length of 7.5 mm and a rated insulation voltage of 32 V at III/2)
Conductor cross section AWG	24 ... 20
Conductor cross section flexible, with ferrule without plastic	0.25 mm <sup>2</sup> ... 0.5 mm <sup>2</sup>

# PTSM 0,5/ 6-PL-2,5 BK - Printed-circuit board connector



1709447

<https://www.phoenixcontact.com/us/products/1709447>

sleeve	
Conductor cross section, flexible, with ferrule, with plastic sleeve	0.25 mm <sup>2</sup> ... 0.34 mm <sup>2</sup>
Cylindrical gauge a x b / diameter	- / 1.2 mm
Stripping length	6 mm

## Material specifications

### Material data - contact

Note	WEEE/RoHS-compliant, free of whiskers according to IEC 60068-2-82/JEDEC JESD 201
Contact material	Cu alloy
Surface characteristics	hot-dip tin-plated
Metal surface terminal point (top layer)	Tin (4 - 8 µm Sn)
Metal surface contact area (top layer)	Tin (4 - 8 µm Sn)

### Material data - housing

Color (Housing)	black (9005)
Insulating material	PA
Insulating material group	I
CTI according to IEC 60112	600
Flammability rating according to UL 94	V0
Glow wire flammability index GWFI according to EN 60695-2-12	850
Glow wire ignition temperature GWIT according to EN 60695-2-13	775
Temperature for the ball pressure test according to EN 60695-10-2	125 °C

## Dimensions

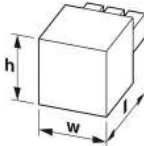
Dimensional drawing	
Pitch	2.5 mm
Width [w]	21.46 mm
Height [h]	15 mm
Length [l]	5.2 mm

## Mounting

Connection method	Push-in spring connection
-------------------	---------------------------

## Mechanical tests

### Conductor connection

Specification	IEC 60999-1:1999-11
Result	Test passed

# PTSM 0,5/ 6-PL-2,5 BK - Printed-circuit board connector



1709447

<https://www.phoenixcontact.com/us/products/1709447>

## Test for conductor damage and slackening

Specification	IEC 60999-1:1999-11
Result	Test passed

## Repeated connection and disconnection

Specification	IEC 60999-1:1999-11
Result	Test passed

## Pull-out test

Specification	IEC 60999-1:1999-11
Conductor cross section/conductor type/tractive force setpoint/actual value	0.14 mm <sup>2</sup> / solid / > 10 N
	0.25 mm <sup>2</sup> / flexible / > 10 N
	0.5 mm <sup>2</sup> / solid / > 20 N
	0.75 mm <sup>2</sup> / flexible / > 30 N

## Insertion and withdrawal forces

Result	Test passed
No. of cycles	10
Insertion strength per pos. approx.	5 N
Withdraw strength per pos. approx.	4 N

## Resistance of inscriptions

Specification	IEC 60068-2-70:1995-12
Result	Test passed

## Polarization and coding

Specification	IEC 60512-13-5:2006-02
Result	Test passed

## Visual inspection

Specification	IEC 60512-1-1:2002-02
Result	Test passed

## Dimension check

Specification	IEC 60512-1-2:2002-02
Result	Test passed

## Environmental and real-life conditions

### Vibration test

Specification	IEC 60068-2-6:2007-12
Frequency	10 - 150 - 10 Hz
Sweep speed	1 octave/min
Amplitude	0.35 mm (10 Hz ... 60.1 Hz)
Sweep speed	5g (60.1 Hz ... 150 Hz)
Test duration per axis	2.5 h

### Durability test

# PTSM 0,5/ 6-PL-2,5 BK - Printed-circuit board connector



1709447

<https://www.phoenixcontact.com/us/products/1709447>

Specification	IEC 60512-9-1:2010-03
Impulse withstand voltage at sea level	2.95 kV
Contact resistance R <sub>1</sub>	3 mΩ
Contact resistance R <sub>2</sub>	4 mΩ
Insertion/withdrawal cycles	10

## Climatic test

Specification	ISO 6988:1985-02
Corrosive stress	0.2 dm <sup>3</sup> SO <sub>2</sub> on 300 dm <sup>3</sup> /40 °C/1 cycle
Thermal stress	100 °C/168 h
Power-frequency withstand voltage	1.39 kV

## Shocks

Specification	IEC 60068-2-27:2008-02
Pulse shape	Semi-sinusoidal
Acceleration	30g
Shock duration	18 ms
Test directions	X-, Y- and Z-axis (pos. and neg.)

## Ambient conditions

Ambient temperature (operation)	-40 °C ... 100 °C (dependent on the derating curve)
Ambient temperature (storage/transport)	-40 °C ... 70 °C
Relative humidity (storage/transport)	30 % ... 70 %
Ambient temperature (assembly)	-5 °C ... 100 °C

## Electrical tests

### Thermal test | Test group C

Specification	IEC 60512-5-1:2002-02
Tested number of positions	8

### Insulation resistance

Specification	IEC 60512-3-1:2002-02
Insulation resistance, neighboring positions	> 5 MΩ

### Temperature cycles

Specification	IEC 60999-1:1999-11
Result	Test passed

### Air clearances and creepage distances |

Specification	IEC 60664-1:2007-04
Insulating material group	I
Comparative tracking index (IEC 60112)	CTI 600
Rated insulation voltage (III/3)	100 V
Rated surge voltage (III/3)	2.5 kV
minimum clearance value - non-homogenous field (III/3)	1.5 mm
minimum creepage distance (III/3)	1.8 mm

# PTSM 0,5/ 6-PL-2,5 BK - Printed-circuit board connector



1709447

<https://www.phoenixcontact.com/us/products/1709447>

Rated insulation voltage (III/2)	160 V
Rated surge voltage (III/2)	2.5 kV
minimum clearance value - non-homogenous field (III/2)	1.5 mm
minimum creepage distance (III/2)	1.5 mm
Rated insulation voltage (II/2)	320 V
Rated surge voltage (II/2)	2.5 kV
minimum clearance value - non-homogenous field (II/2)	1.5 mm
minimum creepage distance (II/2)	1.6 mm

## Packaging specifications

Type of packaging	packed in cardboard
-------------------	---------------------

# PTSM 0,5/ 6-PL-2,5 BK - Printed-circuit board connector



1709447

<https://www.phoenixcontact.com/us/products/1709447>

## Drawings

Diagram

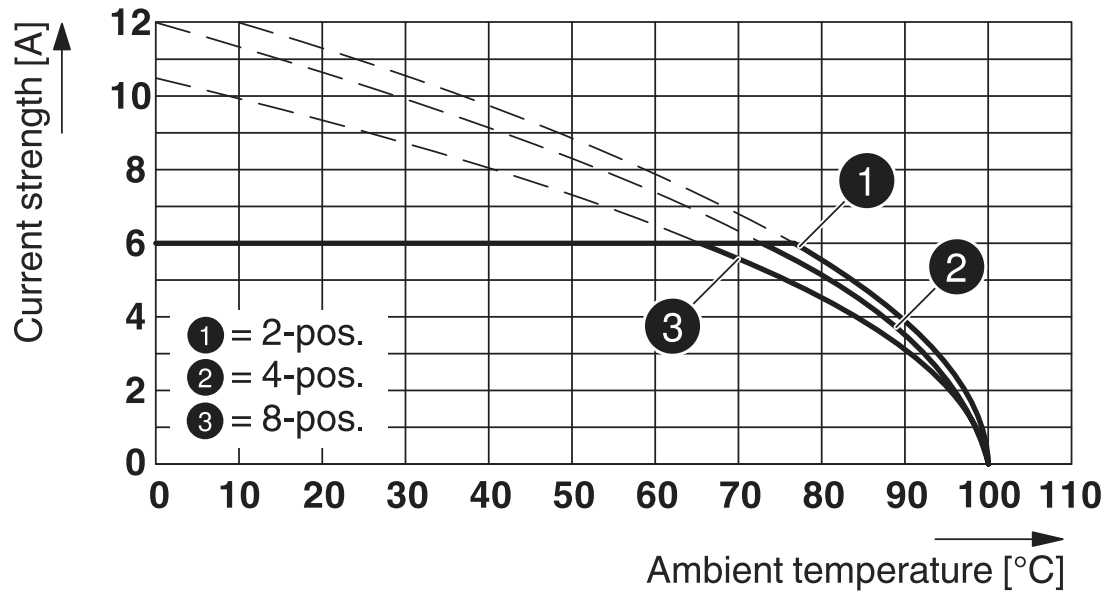

Type: PTSM 0,5/...-PL-2,5 ... with PTSM 0,5/...-HH-2,5-SMD... R...

# PTSM 0,5/ 6-PL-2,5 BK - Printed-circuit board connector





1709447

<https://www.phoenixcontact.com/us/products/1709447>

## Approvals

To download certificates, visit the product detail page: <https://www.phoenixcontact.com/us/products/1709447>

 <b>UL Recognized</b> Approval ID: E118976-20130619				
	Nominal voltage $U_N$	Nominal current $I_N$	Cross section AWG	Cross section $mm^2$
Use group B				
	150 V	5 A	26 - 18	-

 <b>EAC</b> Approval ID: B.01687				
--	--	--	--	--

 <b>cULus Recognized</b> Approval ID: E60425-20101209				
	Nominal voltage $U_N$	Nominal current $I_N$	Cross section AWG	Cross section $mm^2$
Use group B				
	150 V	5 A	26 - 20	-

 <b>VDE Zeichengenehmigung</b> Approval ID: 40048497				
	Nominal voltage $U_N$	Nominal current $I_N$	Cross section AWG	Cross section $mm^2$
	160 V	6 A	-	0.14 - 0.5



# PTSM 0,5/ 6-PL-2,5 BK - Printed-circuit board connector



1709447

<https://www.phoenixcontact.com/us/products/1709447>

## Classifications

### ECLASS

ECLASS-11.0	27460202
ECLASS-12.0	27460202
ECLASS-13.0	27460202

### ETIM

ETIM 8.0	EC002638
----------	----------

### UNSPSC

UNSPSC 21.0	39121400
-------------	----------

# PTSM 0,5/ 6-PL-2,5 BK - Printed-circuit board connector



1709447

<https://www.phoenixcontact.com/us/products/1709447>

## Environmental product compliance

China RoHS	Environmentally friendly use period: unlimited = EFUP-e
	No hazardous substances above threshold values

# PTSM 0,5/ 6-PL-2,5 BK - Printed-circuit board connector



1709447

<https://www.phoenixcontact.com/us/products/1709447>

## Accessories

### SZS 0,4X2,0 - Screwdriver

1205202

<https://www.phoenixcontact.com/us/products/1205202>



Micro screwdriver, bladed, size: 0.4 x 2.0 x 60 mm, 2-component grip, with non-slip grip and twist cap

---

### AI 0,25- 6 BU - Ferrule

3203040

<https://www.phoenixcontact.com/us/products/3203040>



Ferrule, sleeve length: 6 mm, length: 10.5 mm, color: blue

# PTSM 0,5/ 6-PL-2,5 BK - Printed-circuit board connector

1709447

<https://www.phoenixcontact.com/us/products/1709447>

AI 0,25- 6 YE - Ferrule

3203024

<https://www.phoenixcontact.com/us/products/3203024>



Ferrule, sleeve length: 6 mm, length: 10.5 mm, color: yellow

---

AI 0,34- 6 TQ - Ferrule

3203053

<https://www.phoenixcontact.com/us/products/3203053>



Ferrule, sleeve length: 6 mm, length: 10.5 mm, color: turquoise

# PTSM 0,5/ 6-PL-2,5 BK - Printed-circuit board connector



1709447

<https://www.phoenixcontact.com/us/products/1709447>

## PTSM 0,5/ 6-HH-2,5-SMD R44 - PCB header

1778803

<https://www.phoenixcontact.com/us/products/1778803>



PCB headers, nominal cross section:  $0.5 \text{ mm}^2$ , color: black, nominal current: 6 A, rated voltage (III/2): 160 V, contact surface: Tin, contact connection type: Pin, number of potentials: 6, number of rows: 1, number of positions: 6, number of connections: 6, product range: PTSM 0,5/...-HH-SMD, pitch: 2.5 mm, mounting: SMD soldering, pin layout: Linear pinning, number of solder pins per potential: 1, plug-in system: COMBICON PTSM, Pin connector pattern alignment: Standard, locking: without, mounting: without, type of packaging: 44 mm wide tape, Article with anti-rotation pin

---

## PTSM 0,5/ 6-HH0-2,5-SMD R44 - PCB header

1808239

<https://www.phoenixcontact.com/us/products/1808239>



PCB headers, nominal cross section:  $0.5 \text{ mm}^2$ , color: black, nominal current: 6 A, rated voltage (III/2): 160 V, contact surface: Tin, contact connection type: Pin, number of potentials: 6, number of rows: 1, number of positions: 6, number of connections: 6, product range: PTSM 0,5/...-HH-SMD, pitch: 2.5 mm, mounting: SMD soldering, pin layout: Linear pinning, number of solder pins per potential: 1, plug-in system: COMBICON PTSM, Pin connector pattern alignment: Standard, locking: without, mounting: without, type of packaging: 44 mm wide tape

# PTSM 0,5/ 6-PL-2,5 BK - Printed-circuit board connector



1709447

<https://www.phoenixcontact.com/us/products/1709447>

## PTSM 0,5/ 6-HH1-2,5-THR R32 - PCB header

1814812

<https://www.phoenixcontact.com/us/products/1814812>



PCB headers, nominal cross section:  $0.5 \text{ mm}^2$ , color: black, nominal current: 6 A, rated voltage (III/2): 160 V, contact surface: Tin, contact connection type: Pin, number of potentials: 6, number of rows: 1, number of positions: 6, number of connections: 6, product range: PTSM 0,5/..-HH-THR, pitch: 2.5 mm, mounting: THR soldering, pin layout: Linear pinning, solder pin [P]: 2 mm, number of solder pins per potential: 1, plug-in system: COMBICON PTSM, Pin connector pattern alignment: Standard, locking: without, mounting: without, type of packaging: 32 mm wide tape, Article with anti-rotation pin

---

## PTSM 0,5/ 6-HH-2,5-THR R32 - PCB header

1778667

<https://www.phoenixcontact.com/us/products/1778667>



PCB headers, nominal cross section:  $0.5 \text{ mm}^2$ , color: black, nominal current: 6 A, rated voltage (III/2): 160 V, contact surface: Tin, contact connection type: Pin, number of potentials: 6, number of rows: 1, number of positions: 6, number of connections: 6, product range: PTSM 0,5/..-HH-THR, pitch: 2.5 mm, mounting: THR soldering, pin layout: Linear pinning, solder pin [P]: 2.1 mm, number of solder pins per potential: 1, plug-in system: COMBICON PTSM, Pin connector pattern alignment: Standard, locking: without, mounting: without, type of packaging: 32 mm wide tape

# PTSM 0,5/ 6-PL-2,5 BK - Printed-circuit board connector



1709447

<https://www.phoenixcontact.com/us/products/1709447>

## PTSM 0,5/ 6-HV-2,5-THR R32 - PCB header

1778599

<https://www.phoenixcontact.com/us/products/1778599>

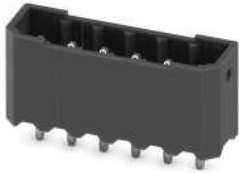

PCB headers, nominal cross section: 0.5 mm<sup>2</sup>, color: black, nominal current: 6 A, rated voltage (III/2): 160 V, contact surface: Tin, contact connection type: Pin, number of potentials: 6, number of rows: 1, number of positions: 6, number of connections: 6, product range: PTSM 0,5/..-HV-THR, pitch: 2.5 mm, mounting: THR soldering, pin layout: Linear pinning, solder pin [P]: 2 mm, number of solder pins per potential: 1, plug-in system: COMBICON PTSM, Pin connector pattern alignment: Standard, locking: without, mounting: without, type of packaging: 32 mm wide tape

## PTSM 0,5/ 6-PI-2,5 BK - Printed-circuit board connector

1709439

<https://www.phoenixcontact.com/us/products/1709439>



PCB connector, nominal cross section: 0.5 mm<sup>2</sup>, color: black, nominal current: 6 A, rated voltage (III/2): 160 V, contact surface: Tin, contact connection type: Pin, number of potentials: 6, number of rows: 1, number of positions: 6, number of connections: 6, product range: PTSM 0,5/..-PI, pitch: 2.5 mm, connection method: Push-in spring connection, conductor/PCB connection direction: 0 °, plug-in system: COMBICON PTSM, locking: without, mounting: without, type of packaging: packed in cardboard

Phoenix Contact 2023 © - all rights reserved  
<https://www.phoenixcontact.com>

Phoenix Contact USA  
586 Fulling Mill Road  
Middletown, PA 17057, United States  
(+717) 944-1300  
[info@phoenixcon.com](mailto:info@phoenixcon.com)