

LM48520 Boomer® Audio Power Amplifier Series Boosted Stereo Class D Audio Power Amplifier with Output Speaker Protection and Spread Spectrum

Check for Samples: [LM48520](#), [LM48520TLBD](#)

FEATURES

- Click and Pop Suppression
- Low 0.04µA Shutdown Current
- 78% Efficiency
- Filterless Class D
- 2.7V - 5.0V Operation
- 4 Adjustable Gain Settings
- Adjustable Output Swing Limiter with Soft Clipping
- Speaker Protection
- Short Circuit Protection on Audio Amps
- Independent Boost and Amplifier Shutdown Pins

APPLICATIONS

- Mobile Phones
- PDAs
- Portable media
- Cameras
- Handheld games

KEY SPECIFICATIONS

- Quiescent Power Supply Current: 11.5 mA(typ)
- Output Power ($R_L = 8\Omega$, THD+N $\leq 1\%$, $V_{DD} = 3.3V$, PV1 = 5.0V): 1.1 W(typ)
- Shutdown Current: 0.04 µA(typ)

DESCRIPTION

The LM48520 integrates a boost converter with a high efficiency Class D stereo audio power amplifier to provide up to 1W/ch continuous power into an 8Ω speaker when operating from 2.7V to 5.0V power supply with boost voltage (PV1) of 5.0V. The LM48520 utilizes a proprietary spread spectrum pulse width modulation technique that lowers RF interference and EMI levels. The Class D amplifier is a low noise, filterless PWM architecture that eliminates the output filter, reducing external component count, board area, power consumption, system cost, and simplifying design.

The LM48520 is designed for use in mobile phones and other portable communication devices. The high (78%) efficiency extends battery life when compared to Boosted Class AB amplifiers. The LM48520 features a low-power consumption shutdown mode. Shutdown may be enabled by driving the Shutdown pin to a logic low (GND). Also, external leakage is minimized via control of the ground reference via the SW-OUT pin.

The LM48520 has 4 gain options which are pin selectable via Gain0 and Gain1 pins. Output short circuit prevents the device from damage during fault conditions. Superior click and pop suppression eliminates audible transients during power-up and shutdown.



Please be aware that an important notice concerning availability, standard warranty, and use in critical applications of Texas Instruments semiconductor products and disclaimers thereto appears at the end of this data sheet.

All trademarks are the property of their respective owners.

Typical Application

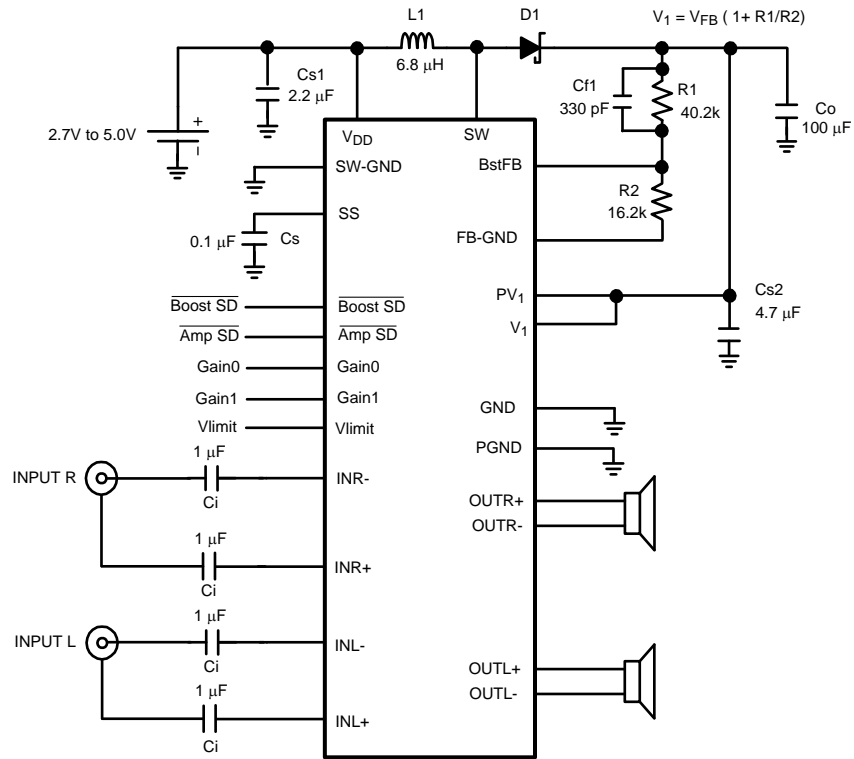

Figure 1. Typical LM48520 Audio Amplifier Application Circuit

Connection Diagram

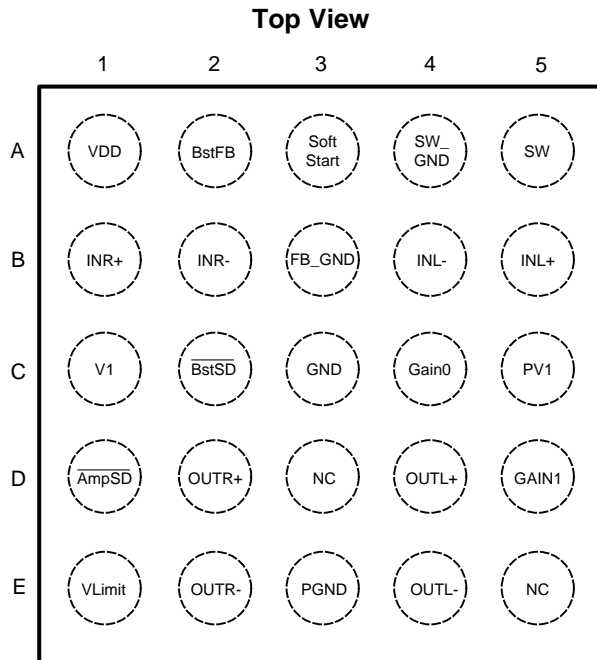

Figure 2. DSBGA Package
See Package Number YZR0025AAA

Pin Descriptions

Pin Designator	Pin Name	Pin Function
A1	VDD	Power Supply
A2	BstFB	Regulator Feedback Input. Connect BstFB to an external resistive voltage divider to set the boost output voltage.
A3	Soft Start	Soft start capacitor
A4	SW_GND	Booster ground
A5	SW	Drain of the Internal FET switch
B1	INR+	Non-inverting right channel input
B2	INR-	Inverting right channel input
B3	FB_GND	Ground return for R1, R2 resistor divider
B4	INL-	Inverting left channel input
B5	INL+	Non-inverting left channel input
C1	V1	Amplifier supply voltage. Connect to PV1.
C2	$\overline{\text{BstSD}}$	Regulator active low shutdown
C3	GND	Ground
C4	Gain0	Gain setting input 0
C5	PV1	Amplifier H-bridge power supply. Connect to V1.
D1	$\overline{\text{AmpSD}}$	Amplifier active low shutdown
D2	OUTR+	Non-inverting right channel output
D3	NC	No connect
D4	OUTL+	Non-inverting left channel output
D5	Gain1	Gain setting input 1
E1	VLimit	Set to control output clipping level
E2	OUTR-	Inverting right channel output
E3	PGND	Power ground
E4	OUTL-	Inverting left channel output
E5	NC	No connect



These devices have limited built-in ESD protection. The leads should be shorted together or the device placed in conductive foam during storage or handling to prevent electrostatic damage to the MOS gates.

Absolute Maximum Ratings ⁽¹⁾⁽²⁾

Supply Voltage (V_{DD} , V_1)	6V
Storage Temperature	-65°C to +150°C
Input Voltage	-0.3V to $V_{DD} + 0.3V$
Power Dissipation ⁽³⁾	Internally limited
ESD Susceptibility ⁽⁴⁾	2000V
ESD Susceptibility ⁽⁵⁾	200V
Junction Temperature	150°C
Thermal Resistance θ_{JA} (YZR0025AAA)	40.5 °C/W

- Absolute Maximum Ratings* indicate limits beyond which damage to the device may occur. *Operating Ratings* indicate conditions for which the device is functional, but do not ensure specific performance limits. *Electrical Characteristics* state DC and AC electrical specifications under particular test conditions which ensure specific performance limits. This assumes that the device is within the Operating Ratings. Specifications are not ensured for parameters where no limit is given, however, the typical value is a good indication of device performance.
- If Military/Aerospace specified devices are required, please contact the Texas Instruments Sales Office/ Distributors for availability and specifications.
- The maximum power dissipation must be derated at elevated temperatures and is dictated by T_{JMAX} , θ_{JA} , and the ambient temperature, T_A . The maximum allowable power dissipation is $P_{DMAX} = (T_{JMAX} - T_A) / \theta_{JA}$ or the given in Absolute Maximum Ratings, whichever is lower.
- Human body model, 100pF discharged through a 1.5kΩ resistor.
- Machine Model, 220pF–240pF discharged through all pins.

Operating Ratings

Temperature Range	
$T_{MIN} \leq T_A \leq T_{MAX}$	$-40^{\circ}\text{C} \leq T_A \leq +85^{\circ}\text{C}$
Supply Voltage (V_{DD})	$2.7\text{V} \leq V_{DD} \leq 5.0\text{V}$
Amplifier Voltage (V_1)	
Not under Boosted Condition	$2.4\text{V} \leq V_1 \leq 5.5\text{V}$
Amplifier Voltage (PV_1)	
Under Boosted Condition	$3.0\text{V} \leq PV_1 \leq 5.0\text{V}$

Electrical Characteristics $V_{DD} = 3.3\text{V}$ ⁽¹⁾⁽²⁾

The following specifications apply for $V_{DD} = 3.3\text{V}$, $A_V = 6\text{dB}$, $R_L = 15\mu\text{H} + 8\Omega + 15\mu\text{H}$, $f_{IN} = 1\text{kHz}$, unless otherwise specified. Limits apply for $T_A = 25^{\circ}\text{C}$, $R_1 = 40.2\text{k}\Omega$, $R_2 = 16.2\text{k}\Omega$, $V_1 = PV_1 = 5\text{V}$, $V_{limit} = \text{GND}$. All electrical specifications are for amplifier and booster.

Parameter	Test Conditions	LM48520		Units (Limits)	
		Typ (3)	Limit (4) (5)		
I_{DD}	Quiescent Power Supply Current	$V_{IN} = 0, R_{LOAD} = \infty$			
		$V_{DD} = 2.7\text{V}$	14.8		
		$V_{DD} = 3.3\text{V}$	11.5	15.5	mA (max)
		$V_{DD} = 5.0\text{V}$	8.0		
I_{SD}	Shutdown Current	$V_{SHUTDOWN} = \text{GND}$	0.04	1.0	μA (max)
V_{SDIH}	Shutdown Voltage Input High	For SD Boost, SD Amp		1.4	V
V_{SDIL}	Shutdown Voltage Input Low	For SD Boost, SD Amp		0.4	V
T_{WU}	Wake-up Time	Amplifier + Booster Wakeup	3		ms
V_{OS}	Output Offset Voltage		5		mV
A_V	Gain	$G_0, G_1 = \text{GND}$ $R_L = \infty$	6		dB
		$G_0 = V_{DD}, G_1 = \text{GND}$ $R_L = \infty$	12		dB
		$G_0 = \text{GND}, G_1 = V_{DD}$ $R_L = \infty$	18		dB
		$G_0, G_1 = V_{DD}$ $R_L = \infty$	24		dB
P_O	Output Power	$R_L = 15\mu\text{H} + 8\Omega + 15\mu\text{H}$ THD+N = 1% (max), $f = 1\text{kHz}, 22\text{kHz}, \text{BW}$ $V_{DD} = 3.3\text{V}$	1.1	0.87	W (min)
		$R_L = 15\mu\text{H} + 8\Omega + 15\mu\text{H}$ THD+N = 10% (max), $f = 1\text{kHz}, 22\text{kHz}, \text{BW}$ $V_{DD} = 3.3\text{V}$	1.3		W
THD+N	Total Harmonic Distortion + Noise	$P_O = 500\text{mW}, f = 1\text{kHz},$ $R_L = 15\mu\text{H} + 8\Omega + 15\mu\text{H},$ $V_{DD} = 3.3\text{V}$	0.04		%
ϵ_{OS}	Output Noise	$V_{DD} = 3.6\text{V}, f = 20\text{Hz} - 20\text{kHz}$ Inputs to AC GND, A weighted	32		μV_{RMS}

- (1) All voltages are measured with respect to the GND pin, unless otherwise specified.
- (2) *Absolute Maximum Ratings* indicate limits beyond which damage to the device may occur. *Operating Ratings* indicate conditions for which the device is functional, but do not ensure specific performance limits. *Electrical Characteristics* state DC and AC electrical specifications under particular test conditions which ensure specific performance limits. This assumes that the device is within the Operating Ratings. Specifications are not ensured for parameters where no limit is given, however, the typical value is a good indication of device performance.
- (3) Typicals are measured at 25°C and represent the parametric norm.
- (4) Limits are specified to AOQL (Average Outgoing Quality Level).
- (5) Datasheet min/max specification limits are ensured by design, test, or statistical analysis.

Electrical Characteristics $V_{DD} = 3.3V$ ⁽¹⁾⁽²⁾ (continued)

The following specifications apply for $V_{DD} = 3.3V$, $A_V = 6dB$, $R_L = 15\mu H + 8\Omega + 15\mu H$, $f_{IN} = 1kHz$, unless otherwise specified. Limits apply for $T_A = 25^\circ C$, $R_1 = 40.2k\Omega$, $R_2 = 16.2k\Omega$, $V_1 = PV_1 = 5V$, $V_{limit} = GND$. All electrical specifications are for amplifier and booster.

Parameter		Test Conditions	LM48520		Units (Limits)
			Typ ⁽³⁾	Limit ^{(4) (5)}	
PSRR	Power Supply Rejection Ratio	$V_{RIPPLE} = 200mV_{P-P}$ Sine, $f_{RIPPLE} = 217Hz$	82		dB
		$V_{RIPPLE} = 200mV_{P-P}$ Sine, $f_{RIPPLE} = 1kHz$	79		dB
CMRR	Common Mode Rejection Ratio	$V_{RIPPLE} = 1V_{P-P}$, $f_{RIPPLE} = 217Hz$	67		dB
η	Efficiency	$P_O = 1W$, $f = 1kHz$, $R_L = 15\mu H + 8\Omega + 15\mu H$ $V_{DD} = 3.3V$ $V_{DD} = 4.2V$	78		%
V_{FB}	Feedback Pin Reference Voltage	See ⁽⁶⁾	1.24		V
$V_{out\ clipped}$	Output Voltage in clipped state with soft clip activated	$V_{limit} = 2V$, $R_L = 8\Omega$, $V_{IN} = 2V_P$ $V_{out\ clipped} = 8/3 (PV_1 - 2V_{limit})$	2.5	1.9 3.2	Vpk (min) Vpk (max)

(6) Feedback pin reference voltage is measured with the Audio Amplifier disconnected from the Boost converter (the Boost converter is unloaded).

Typical Performance Characteristics

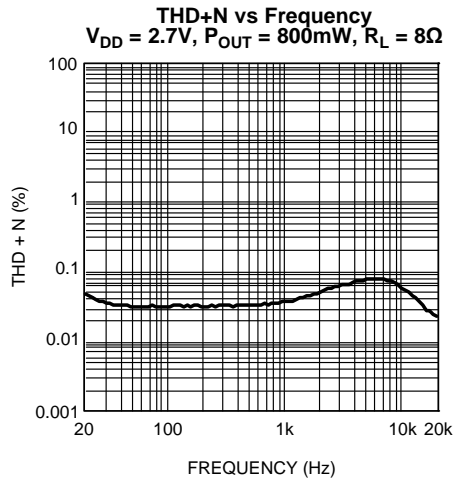

Figure 3.

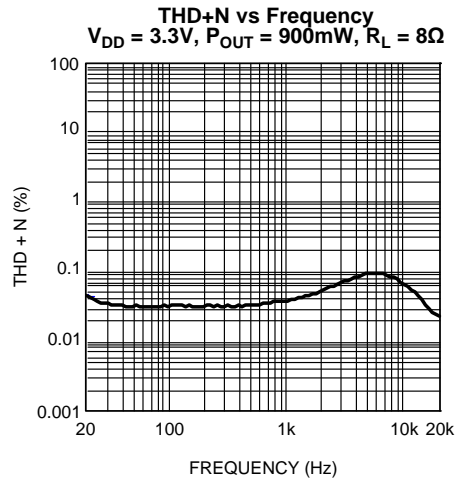

Figure 4.

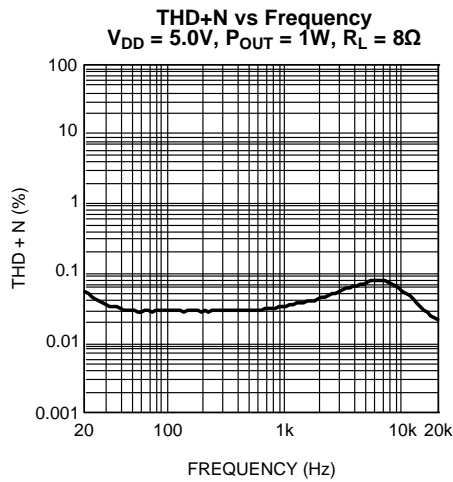

Figure 5.

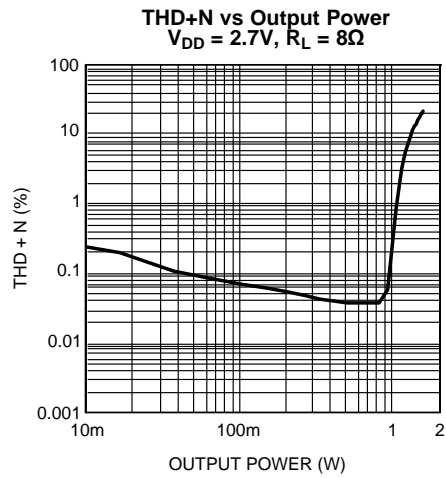

Figure 6.

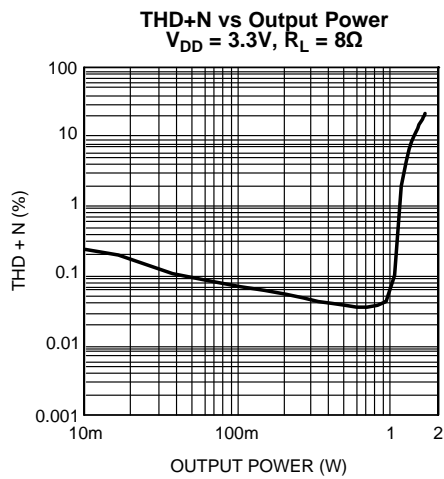

Figure 7.

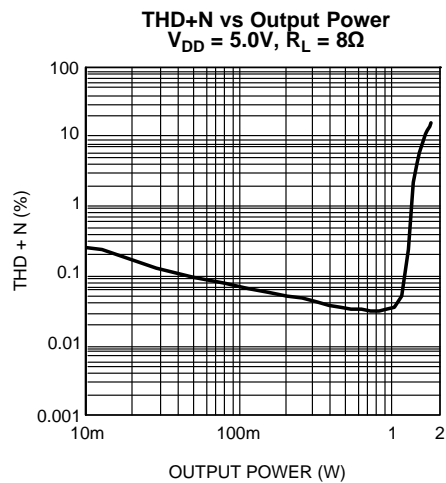

Figure 8.

Typical Performance Characteristics (continued)

Power Dissipation vs Output Power
 $V_{DD} = 2.7V, R_L = 8\Omega, f = 1kHz$

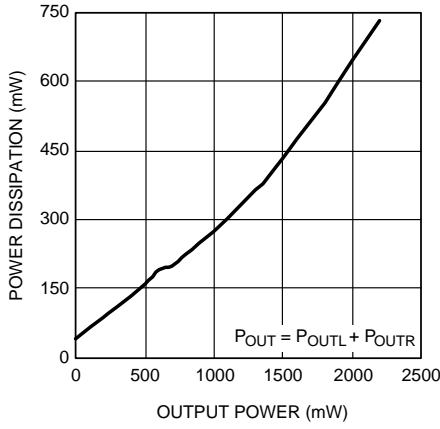

Figure 9.

Power Dissipation vs Output Power
 $V_{DD} = 3.3V, R_L = 8\Omega, f = 1kHz$

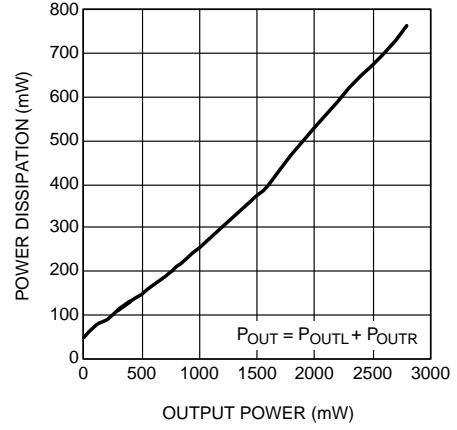

Figure 10.

Power Dissipation vs Output Power
 $V_{DD} = 5.0V, R_L = 8\Omega, f = 1kHz$

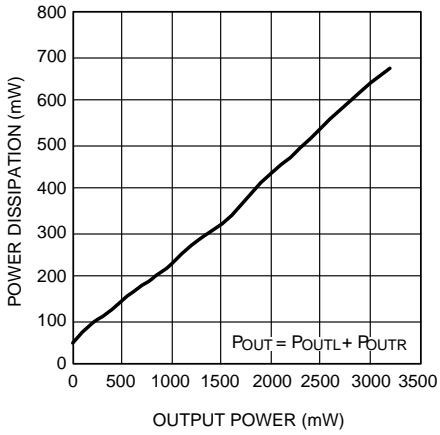

Figure 11.

Efficiency vs Output Power
 $V_{DD} = 2.7V, R_L = 8\Omega, f = 1kHz$

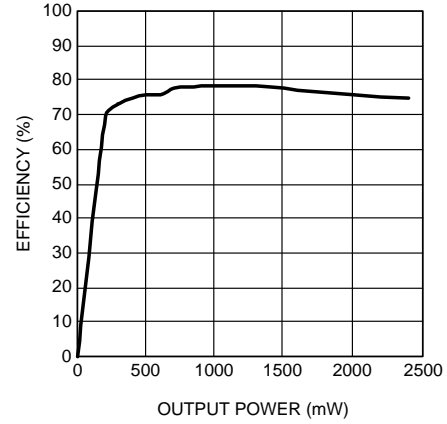

Figure 12.

Efficiency vs Output Power
 $V_{DD} = 3.3V, R_L = 8\Omega, f = 1kHz$

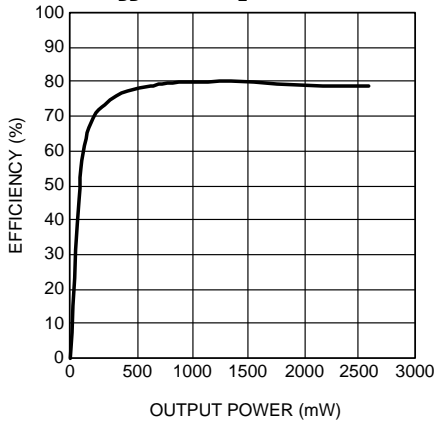

Figure 13.

Efficiency vs Output Power
 $V_{DD} = 5.0V, R_L = 8\Omega, f = 1kHz$

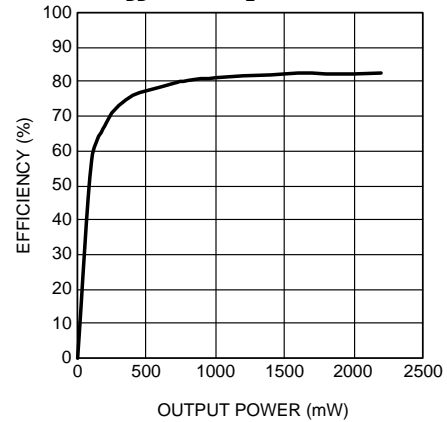

Figure 14.

Typical Performance Characteristics (continued)

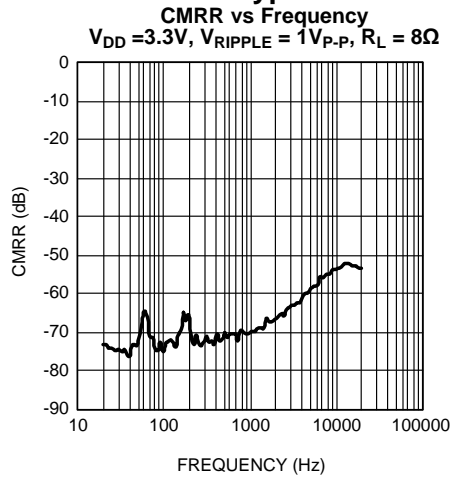

Figure 15.

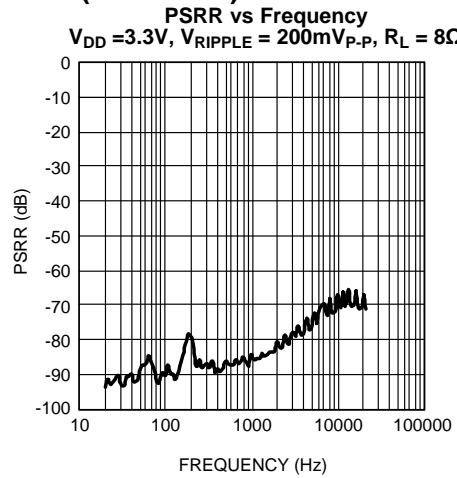

Figure 16.

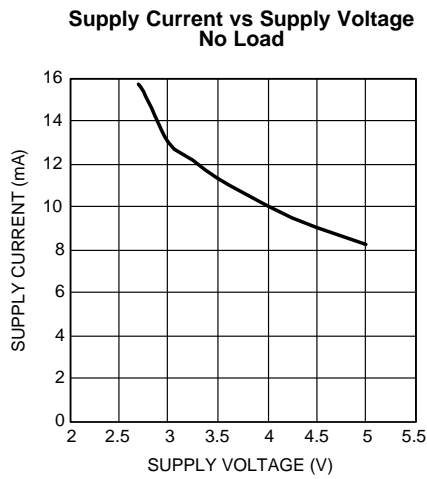

Figure 17.

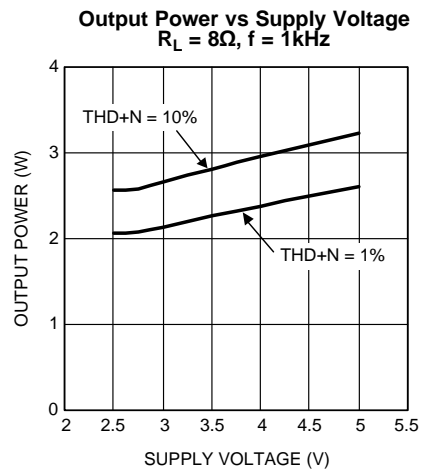

Figure 18.

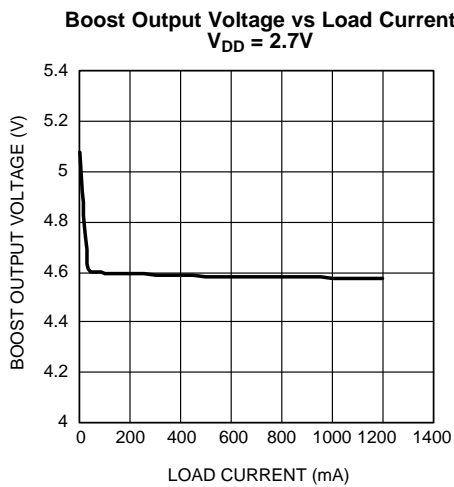

Figure 19.

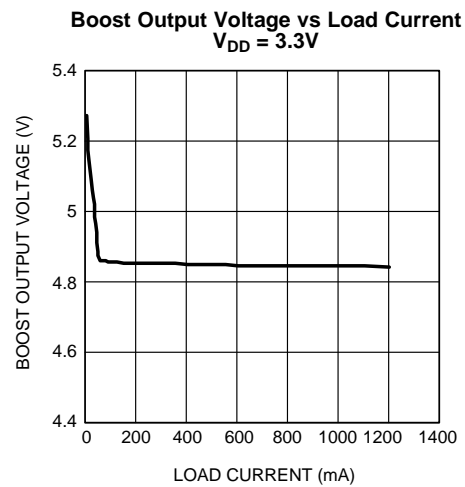

Figure 20.

Typical Performance Characteristics (continued)

Boost Output Voltage vs Load Current
 $V_{DD} = 5.0V$

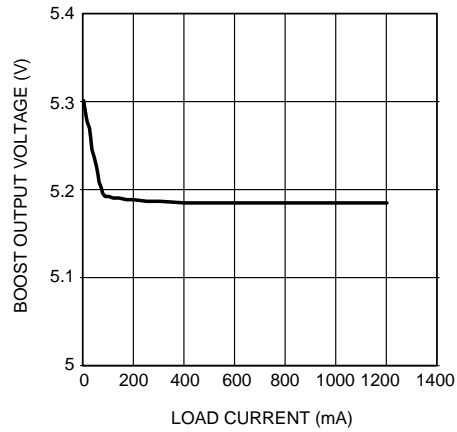

Figure 21.

APPLICATION INFORMATION

General Amplifier Function

The LM48520 features a Class D audio power amplifier that utilizes a filterless modulation scheme, reducing external component count, conserving board space and reducing system cost. The outputs of the device transition from PV1 to GND with a 300kHz switching frequency. With no signal applied, the outputs (V_{LS+} and V_{LS-}) switch with a 50% duty cycle, in phase, causing the two outputs to cancel. This cancellation results in no net voltage across the speaker, thus there is no current to the load in the idle state.

With the input signal applied, the duty cycle (pulse width) of the LM48520 outputs changes. For increasing output voltage, the duty cycle of V_{LS+} increases, while the duty cycle of V_{LS-} decreases. For decreasing output voltages, the converse occurs. The difference between the two pulse widths yields the differential output voltage.

Differential Amplifier Explanation

The amplifier portion of the LM48520 is a fully differential amplifier that features differential input and output stages. A differential amplifier amplifies the difference between the two input signals. Traditional audio power amplifiers have typically offered only single-ended inputs resulting in a 6dB reduction in signal to noise ratio relative to differential inputs. The amplifier also offers the possibility of DC input coupling which eliminates the two external AC coupling, DC blocking capacitors. The amplifier can be used, however, as a single ended input amplifier while still retaining it's fully differential benefits. In fact, completely unrelated signals may be placed on the input pins. The amplifier portion of the LM48520 simply amplifies the difference between the signals. A major benefit of a differential amplifier is the improved common mode rejection ratio (CMRR) over single input amplifiers. The common-mode rejection characteristic of the differential amplifier reduces sensitivity to ground offset related noise injection, especially important in high noise applications.

Amplifier Dissipation and Efficiency

The major benefit of a Class D amplifier is increased efficiency versus a Class AB. The efficiency of the LM48520 is attributed to the region of operation of the transistors in the output stage. The Class D output stage acts as current steering switches, consuming negligible amounts of power compared to their Class AB counterparts. Most of the power loss associated with the output stage is due to the IR loss of the MOSFET on-resistance, along with switching losses due to gate charge.

Regulator Power Dissipation

At higher duty cycles, the increased ON-time of the switch FET means the maximum output current will be determined by power dissipation within the LM48520 FET switch. The switch power dissipation from ON-time conduction is calculated by:

$$P_{D(SWITCH)} = DC \times (I_{INDUCTOR(AVE)})^2 \times R_{DS(ON)} \quad (W) \quad (1)$$

where:

Where DC is the duty cycle

Shutdown Function

The LM48520 features independent amplifier and regulator shutdown controls, allowing each portion of the device to be disabled or enabled independently. AmpSD controls the Class D amplifiers, while BstSD controls the regulator. Driving either inputs low disables the corresponding portion of the device, and reducing supply current.

When the regulator is disabled, both FB_GND switches open, further reducing shutdown current by eliminating the current path to GND through the regulator feedback network. With the regulator disabled, there is still a current path from V_{DD} , through the inductor and diode, to the amplifier power supply. This allows the amplifier to operate even when the regulator is disabled. The voltage at PV1 and V1 will be:

$$V_{DD} - [V_D + (I_L \times DCR)] \quad (2)$$

where:

V_D is the forward voltage of the Schottky diode

I_L is the current through the inductor

DCR is the DC resistance of the inductor

Additionally, when the regulator is disabled, an external voltage between 2.4V and 5.5V can be applied directly to PV1 and V1 to power the amplifier.

It is best to switch between ground and V_{DD} for minimum current consumption while in shutdown. The LM48520 may be disabled with shutdown voltages in between GND and V_{DD} , the idle current will be greater than the typical 0.1µA value. Increased THD+N may also be observed when a voltage of less than V_{DD} is applied to AmpSD.

Proper Selection of External Components

Proper selection of external components in applications using integrated power amplifiers, and switching DC-DC converters, is critical for optimizing device and system performance. Consideration to component values must be used to maximize overall system quality.

The best capacitors for use with the switching converter portion of the LM48520 are multi-layer ceramic capacitors. They have the lowest ESR (equivalent series resistance) and highest resonance frequency, which makes them optimum for high frequency switching converters.

When selecting a ceramic capacitor, only X5R and X7R dielectric types should be used. Other types such as Z5U and Y5F have such severe loss of capacitance due to effects of temperature variation and applied voltage, they may provide as little as 20% of rated capacitance in many typical applications. Always consult capacitor manufacturer's data curves before selecting a capacitor. High-quality ceramic capacitors can be obtained from Taiyo-Yuden, AVX, and Murata.

Power Supply Bypassing for Amplifier

As with any amplifier, proper supply bypassing is critical for low noise performance and high power supply rejection. The capacitor location on both PV1, V1 and V_{DD} pins should be as close to the device as possible.

Selecting Input Capacitor for Audio Amplifier

Input capacitors, C_{IN} , in conjunction with the input impedance of the LM48520 forms a high pass filter that removes the DC bias from an incoming signal. The AC-coupling capacitor allows the amplifier to bias the signal to an optimal DC level. Assuming zero source impedance, the -3dB point of the high pass filter is given by:

$$f_{(-3dB)} = 1/2\pi R_{IN} C_{IN} \quad (3)$$

Choose C_{IN} such that f_{-3dB} is well below that lowest frequency of interest. Setting f_{-3dB} too high affects the low-frequency responses of the amplifier. Use capacitors with low voltage coefficient dielectrics, such as tantalum or aluminum electrolytic. Capacitors with high-voltage coefficients, such as ceramics, may result in increased distortion at low frequencies. Other factors to consider when designing the input filter include the constraints of the overall system. Although high fidelity audio requires a flat frequency response between 20Hz and 20kHz, portable devices such as cell phones may only concentrate on the frequency range of the frequency range of the spoken human voice (typically 300Hz to 4kHz). In addition, the physical size of the speakers used in such portable devices limits the low frequency response; in this case, frequencies below 150Hz may be filtered out.

Selecting Output Capacitor (C_o) for Boost Converter

A single 100µF low ESR tantalum capacitor provides sufficient output capacitance for most applications. Higher capacitor values improve line regulation and transient response. Typical electrolytic capacitors are not suitable for switching converters that operate above 500kHz because of significant ringing and temperature rise due to self-heating from ripple current. An output capacitor with excessive ESR reduces phase margin and causes instability.

Selecting Input Capacitor (C_{s1}) for Boost Converter

An input capacitor is required to serve as an energy reservoir for the current which must flow into the coil each time the switch turns ON. This capacitor must have extremely low ESR, so ceramic is the best choice. We recommend a nominal value of 2.2µF, but larger values can be used. Since this capacitor reduces the amount of voltage ripple seen at the input pin, it also reduces the amount of EMI passed back along that line to other circuitry.

Selecting Soft-Start (C_{SS}) Capacitor

The soft-start function charges the boost converter reference voltage slowly. This allows the output of the boost converter to ramp up slowly thus limiting the transient current at startup. Selecting a soft-start capacitor (C_{SS}) value presents a trade off between the wake-up time and the startup transient current. Using a larger capacitor value will increase wake-up time and decrease startup transient current while the opposite effect happens with a smaller capacitor value. A general guideline is to use a capacitor value 1000 times smaller than the output capacitance of the boost converter (C_O). A 0.1 μ F soft-start capacitor is recommended for a typical application.

Setting the Output Voltage (V_1) of boost Converter

The output voltage is set using the external resistors R1 and R2 (see [Figure 1](#)). A value of approximately 13.3k Ω is recommended for R2 to establish a divider current of approximately 92 μ A. R1 is calculated using the formula:

$$R1 = R2 \times (V_1 / 1.23 - 1) \quad (4)$$

Feed-Forward Compensation for Boost Converter

Although the LM48520's internal Boost converter is internally compensated, the external feed-forward capacitor C_f is required for stability (see [Figure 1](#)). Adding this capacitor puts a zero in the loop response of the converter. The recommended frequency for the zero f_z should be approximately 6kHz. C_f can be calculated using the formula:

$$C_f = 1 / (2 \times R1 \times f_z) \quad (5)$$

Selecting Diodes for Boost

The external diode used in [Figure 1](#) should be a Schottky diode. A 20V diode such as the MBRS320T3 is recommended.

The MBRS320T3 series of diodes are designed to handle a maximum average current of 3A.

Duty Cycle

The maximum duty cycle of the boost converter determines the maximum boost ratio of output-to-input voltage that the converter can attain in continuous mode of operation. The duty cycle for a given boost application is defined as:

$$\text{Duty Cycle} = (V_{OUT} + V_{DIODE} - V_{IN}) / (V_{OUT} + V_{DIODE} - V_{SW}) \quad (6)$$

This applies for continuous mode operation.

Selecting Inductor Value

Inductor value involves trade-offs in performance. Larger inductors reduce inductor ripple current, which typically means less output voltage ripple (for a given size of output capacitor). Larger inductors also mean more load power can be delivered because the energy stored during each switching cycle is:

$$E = L/2 \times (I_p)^2 \quad (7)$$

Where "I_p" is the peak inductor current. The LM48520 will limit its switch current based on peak current. With I_p fixed, increasing L will increase the maximum amount of power available to the load. Conversely, using too little inductance may limit the amount of load current which can be drawn from the output. Best performance is usually obtained when the converter is operated in "continuous" mode at the load current range of interest, typically giving better load regulation and less output ripple. Continuous operation is defined as not allowing the inductor current to drop to zero during the cycle. Boost converters shift over to discontinuous operation if the load is reduced far enough, but a larger inductor stays continuous over a wider load current range.

During the TB μ s ON-time, the inductor current ramps up TBDA and ramps down an equal amount during the OFF-time. This is defined as the inductor "ripple current". It can also be seen that if the load current drops to about TBDA, the inductor current will begin touching the zero axis which means it will be in discontinuous mode. A similar analysis can be performed on any boost converter, to make sure the ripple current is reasonable and continuous operation will be maintained at the typical load current values.

Maximum Switch Current

The maximum FET switch current available before the current limiter cuts in is dependent on duty cycle of the application. This is illustrated in a graph in the [Typical Performance Characteristics](#) section which shows typical values of switch current as a function of effective (actual) duty cycle.

Calculating Output Current of Boost Converter (I_{AMP})

The load current is related to the average inductor current by the relation:

$$I_{LOAD} = I_{IND}(AVG) \times (1 - DC) \quad (8)$$

where:

"DC" is the duty cycle of the application

The switch current can be found by:

$$I_{SW} = I_{IND}(AVG) + 1/2 (I_{RIPPLE}) \quad (9)$$

Inductor ripple current is dependent on inductance, duty cycle, input voltage and frequency:

$$I_{RIPPLE} = DC \times (V_{IN} - V_{SW}) / (f \times L) \quad (10)$$

combining all terms, we can develop an expression which allows the maximum available load current to be calculated:

$$I_{LOAD(max)} = (1 - DC) \times (I_{SW(max)} - DC(V_{IN} - V_{SW})) / fL \quad (11)$$

The equation shown to calculate maximum load current takes into account the losses in the inductor or turn-OFF switching losses of the FET and diode.

Design Parameters V_{SW} and I_{SW}

The value of the FET "ON" voltage (referred to as V_{SW} in [Equation 4](#) thru [Equation 9](#)) is dependent on load current. A good approximation can be obtained by multiplying the "ON Resistance" of the FET times the average inductor current.

FET on resistance increases at V_{IN} values below 5V, since the internal N-FET has less gate voltage in this input voltage range (see [Typical Performance Characteristics](#) curves). Above $V_{IN} = 5V$, the FET gate voltage is internally clamped to 5V.

The maximum peak switch current the device can deliver is dependent on duty cycle. For higher duty cycles, see [Typical Performance Characteristics](#) curves.

Inductor Suppliers

The recommended inductor for the LM48520 is the NR8040T6R8N from Taiyo Yuden. When selecting an inductor, make certain that the continuous current rating is high enough to avoid saturation at peak currents, where:

$$I_{IND} = (PV1 / V_{DD}) \times I_{LOAD(BOOST)} \quad (12)$$

A suitable core type must be used to minimize core (switching) losses, and wire power losses must be considered when selecting the current rating.

PCB Layout Guidelines

High frequency boost converters require very careful layout of components in order to get stable operation and low noise.

All components must be as close as possible to the LM48520 device. It is recommended that a four layer PCB be used so that internal ground planes are available.

Some additional guidelines to be observed (all designators are referencing [Figure 1](#)):

1. Keep the path between L1, D1, and Co extremely short. Parasitic trace inductance in series with D1 and Co will increase noise and ringing.
2. The feedback components R1, R2 and Cf1 must be kept close to the FB pin to prevent noise injection on the FB pin trace.
3. Since the external components of the boost converter are switching, L1 and D1 should be kept away from

the input traces to prevent the noise from injecting into the input.

- The power supply bypass capacitors, Cs1 and Cs2 should be placed as close to the LM48520 device as possible.

GROUNDING GUIDELINES

There are three grounds on the LM48520, GND, SW_GND, and PGND. When laying out the PCB, it is critical to connect the grounds as close to the device as possible. The simplest way to do that is to place vias close to the GND, SW_GND, and PGND bumps and connect the GND, SW_GND, and PGND vias using a single ground plane in an inner layer of the PCB.

Output Speaker Protection Function

The LM48520's output voltage limiter can be used to set a minimum and maximum output voltage swing magnitude. The voltage applied to the VLimit pin controls the limit on the output voltage level. The output level is determined by the following equation:

$$V_{\text{out clipped}} = 8/3 * (PV1 - 2 * V_{\text{limit}}) \quad (13)$$

where:

$V_{\text{out clipped}}$ = the desired output level measured in Vpk

PV1 = Boost output voltage

V_{limit} is the voltage applied to the VLimit pin on the LM48520

or

$$V_{\text{out clipped}} = 1/2 * (PV1 - 3/8 * V_{\text{out clipped}}) \quad (14)$$

To disable the limiter, set $V_{\text{limit}} = 0V$.

Figure 22 provides an example of how the output voltage limiter functions with $V_{DD} = 3.3V$, $A_V = 6dB$, $PV1 = 5V$, $V_{\text{limit}} = 2V$, $R_L = 8\Omega$, $V_{IN} = 2V_P$.

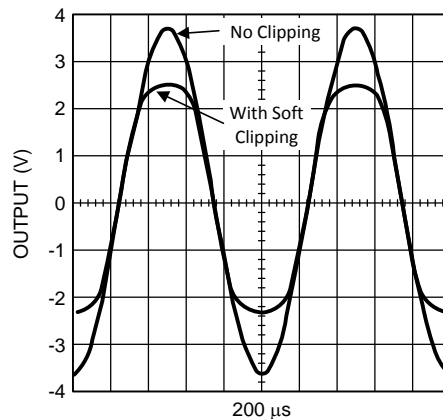

Figure 22. Soft Clipping vs No Clipping

Revision History

Rev	Date	Description
1.0	02/27/08	Initial release.
1.01	03/07/08	Added the Soft clipping vs No clipping curve.
1.02	03/12/08	Text edits.
C	04/05/13	Changed layout of National Data Sheet to TI format.

PACKAGING INFORMATION

Orderable Device	Status (1)	Package Type	Package Drawing	Pins	Package Qty	Eco Plan (2)	Lead finish/ Ball material (6)	MSL Peak Temp (3)	Op Temp (°C)	Device Marking (4/5)	Samples
LM48520TL/NOPB	ACTIVE	DSBGA	YZR	25	250	RoHS & Green	SNAGCU	Level-1-260C-UNLIM	-40 to 85	GI5	Samples

(1) The marketing status values are defined as follows:

ACTIVE: Product device recommended for new designs.

LIFEBUY: TI has announced that the device will be discontinued, and a lifetime-buy period is in effect.

NRND: Not recommended for new designs. Device is in production to support existing customers, but TI does not recommend using this part in a new design.

PREVIEW: Device has been announced but is not in production. Samples may or may not be available.

OBSOLETE: TI has discontinued the production of the device.

(2) **RoHS:** TI defines "RoHS" to mean semiconductor products that are compliant with the current EU RoHS requirements for all 10 RoHS substances, including the requirement that RoHS substance do not exceed 0.1% by weight in homogeneous materials. Where designed to be soldered at high temperatures, "RoHS" products are suitable for use in specified lead-free processes. TI may reference these types of products as "Pb-Free".

RoHS Exempt: TI defines "RoHS Exempt" to mean products that contain lead but are compliant with EU RoHS pursuant to a specific EU RoHS exemption.

Green: TI defines "Green" to mean the content of Chlorine (Cl) and Bromine (Br) based flame retardants meet JS709B low halogen requirements of <=1000ppm threshold. Antimony trioxide based flame retardants must also meet the <=1000ppm threshold requirement.

(3) MSL, Peak Temp. - The Moisture Sensitivity Level rating according to the JEDEC industry standard classifications, and peak solder temperature.

(4) There may be additional marking, which relates to the logo, the lot trace code information, or the environmental category on the device.

(5) Multiple Device Markings will be inside parentheses. Only one Device Marking contained in parentheses and separated by a "-" will appear on a device. If a line is indented then it is a continuation of the previous line and the two combined represent the entire Device Marking for that device.

(6) Lead finish/Ball material - Orderable Devices may have multiple material finish options. Finish options are separated by a vertical ruled line. Lead finish/Ball material values may wrap to two lines if the finish value exceeds the maximum column width.

Important Information and Disclaimer: The information provided on this page represents TI's knowledge and belief as of the date that it is provided. TI bases its knowledge and belief on information provided by third parties, and makes no representation or warranty as to the accuracy of such information. Efforts are underway to better integrate information from third parties. TI has taken and continues to take reasonable steps to provide representative and accurate information but may not have conducted destructive testing or chemical analysis on incoming materials and chemicals. TI and TI suppliers consider certain information to be proprietary, and thus CAS numbers and other limited information may not be available for release.

In no event shall TI's liability arising out of such information exceed the total purchase price of the TI part(s) at issue in this document sold by TI to Customer on an annual basis.

TAPE AND REEL INFORMATION

QUADRANT ASSIGNMENTS FOR PIN 1 ORIENTATION IN TAPE

*All dimensions are nominal

Device	Package Type	Package Drawing	Pins	SPQ	Reel Diameter (mm)	Reel Width W1 (mm)	A0 (mm)	B0 (mm)	K0 (mm)	P1 (mm)	W (mm)	Pin1 Quadrant
LM48520TL/NOPB	DSBGA	YZR	25	250	178.0	8.4	2.69	2.69	0.76	4.0	8.0	Q1

TAPE AND REEL BOX DIMENSIONS

*All dimensions are nominal

Device	Package Type	Package Drawing	Pins	SPQ	Length (mm)	Width (mm)	Height (mm)
LM48520TL/NOPB	DSBGA	YZR	25	250	208.0	191.0	35.0

YZR0025

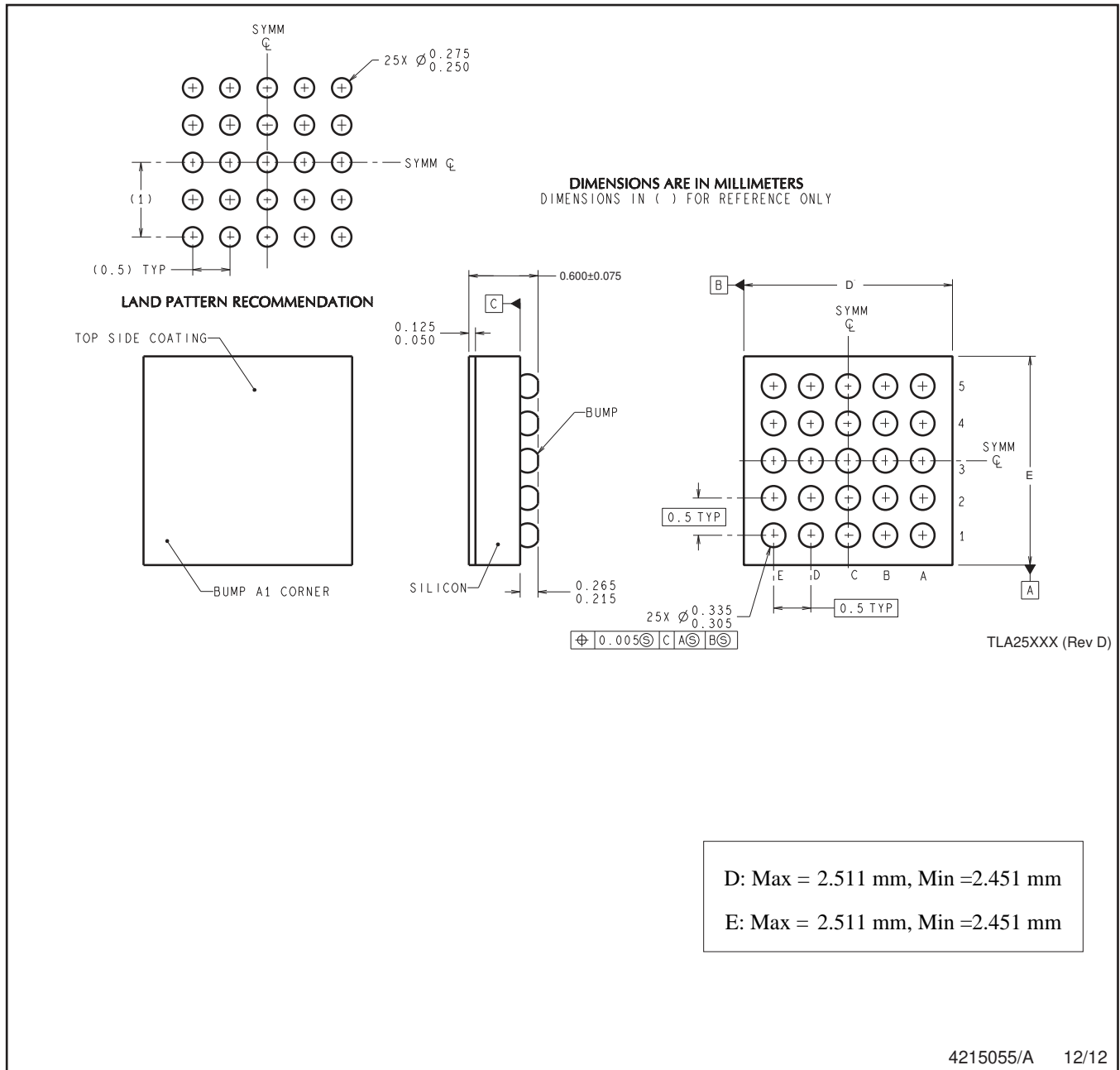

4215055/A 12/12

NOTES: A. All linear dimensions are in millimeters. Dimensioning and tolerancing per ASME Y14.5M-1994.
B. This drawing is subject to change without notice.

IMPORTANT NOTICE AND DISCLAIMER

TI PROVIDES TECHNICAL AND RELIABILITY DATA (INCLUDING DATA SHEETS), DESIGN RESOURCES (INCLUDING REFERENCE DESIGNS), APPLICATION OR OTHER DESIGN ADVICE, WEB TOOLS, SAFETY INFORMATION, AND OTHER RESOURCES "AS IS" AND WITH ALL FAULTS, AND DISCLAIMS ALL WARRANTIES, EXPRESS AND IMPLIED, INCLUDING WITHOUT LIMITATION ANY IMPLIED WARRANTIES OF MERCHANTABILITY, FITNESS FOR A PARTICULAR PURPOSE OR NON-INFRINGEMENT OF THIRD PARTY INTELLECTUAL PROPERTY RIGHTS.

These resources are intended for skilled developers designing with TI products. You are solely responsible for (1) selecting the appropriate TI products for your application, (2) designing, validating and testing your application, and (3) ensuring your application meets applicable standards, and any other safety, security, regulatory or other requirements.

These resources are subject to change without notice. TI grants you permission to use these resources only for development of an application that uses the TI products described in the resource. Other reproduction and display of these resources is prohibited. No license is granted to any other TI intellectual property right or to any third party intellectual property right. TI disclaims responsibility for, and you will fully indemnify TI and its representatives against, any claims, damages, costs, losses, and liabilities arising out of your use of these resources.

TI's products are provided subject to [TI's Terms of Sale](#) or other applicable terms available either on [ti.com](https://www.ti.com) or provided in conjunction with such TI products. TI's provision of these resources does not expand or otherwise alter TI's applicable warranties or warranty disclaimers for TI products.

TI objects to and rejects any additional or different terms you may have proposed.

Mailing Address: Texas Instruments, Post Office Box 655303, Dallas, Texas 75265
Copyright © 2023, Texas Instruments Incorporated