

Reflector with micro-structure

REF-MH20

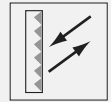

- Mounting holes for simple installation
- Micro-structure

Reflector with Micro-structure, rectangular 32 mm x 20 mm, mounting holes

Dimensions

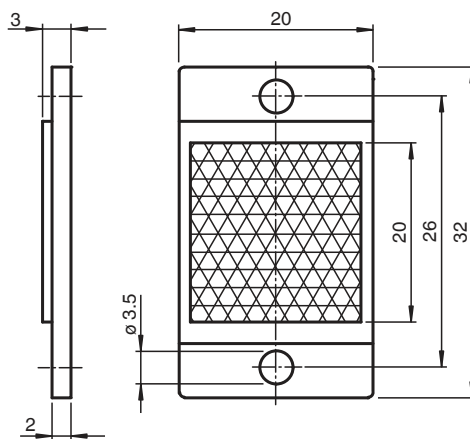

Technical Data

General specifications	
Construction type	rectangular
Tripel height	approx. 1.2 mm
Ambient conditions	
Ambient temperature	-30 ... 85 °C (-22 ... 185 °F)
Mechanical specifications	
Material	PMMA/ABS
Dimensions	32 mm x 20 mm x 3 mm
Mounting	mounting holes

Release date: 2021-12-16 Date of issue: 2021-12-16 Filename: 113952_eng.pdf

Refer to "General Notes Relating to Pepperl+Fuchs Product Information".

Pepperl+Fuchs Group
www.pepperl-fuchs.com

USA: +1 330 486 0001
fa-info@us.pepperl-fuchs.com

Germany: +49 621 776 1111
fa-info@de.pepperl-fuchs.com

Singapore: +65 6779 9091
fa-info@sg.pepperl-fuchs.com

PF PEPPERL+FUCHS