

CD4000-Series Ratings and Classifications

Absolute Maximum Ratings

DC Supply Voltage Range, (V _{DD}) -0.5V to +20V (Voltage Referenced to V _{SS} Terminals)
Input Voltage Range, All Inputs -0.5V to V _{DD} +0.5V
DC Input Current, Any One Input ±10mA
Operating Temperature Range (T _A) -55°C to +125°C Package Types D, F, K, H
Storage Temperature Range (T _{STG}) -65°C to +150°C
Lead Temperature (During Soldering) +265°C At Distance 1/16 ± 1/32 Inch (1.59mm ± 0.79mm) from case for 10s Maximum

Reliability Information

Thermal Resistance	θ _{ja}	θ _{jc}
Ceramic DIP Package 28°C/W	TBD°C/W
Flatpack Package 22°C/W	TBD°C/W
Maximum Package Power Dissipation (P _D) at +125°C		
For T _A = -55°C to +100°C (Package Types D, F, K) 500W	
For T _A = +100°C to +125°C (Package Types D, F, K) Derate Linearity at 12mW/°C to 200mW	
Device Dissipation Per Output Transistor 100mW	
For T _A = Full Package Temperature Range (All Package Types)		
Junction Temperature +175°C	

Recommended Operating Conditions

For maximum reliability, nominal operating conditions should be selected so that operation is always within the following ranges:

Supply Voltage Range 3V Min, 18V Max (For T _A = Full Package Temperature Range)
----------------------	--

Device Classification for Leakage Current

The table below classifies the levels of device leakage as SSI, MSI-1 and MSI-2. In order to determine the limits which apply to a specific device type, consult the standard DC electrical characteristics chart.

CLASSIFICATION ACCORDING TO CIRCUIT COMPLEXITY

GATES/ INVERTERS (SSI)	BUFFERS/FLIP-FLOPS/ LATCHES/MULTILEVEL GATES (MSI-1)	COMPLEX LOGIC (MSI-2)
CD4000B	CD4009UB*	CD4085B
CD4001B	CD4010B	CD4086B
CD4002B	CD4013B	CD4093B*
CD4007UB	CD4019B	CD4095B
CD4011B	CD4027B	CD4096B
CD4012B	CD4030B	CD4098B
CD4016B*	CD4041UB*	CD4502B*
CD4023B	CD4042B	CD4503B*
CD4025B	CD4043B	CD40106B*
CD4048B	CD4044B	CD40107B*
CD4066B*	CD4047B	CD40109B*
CD4068B	CD4049UB*	CD40147B
CD4069UB	CD4050B	CD40174B
CD4071B	CD4070B	CD40175B
CD4072B	CD4077B	CD40257B
CD4073B		
CD4075B		
CD4078B		
CD4081B		
CD4082B		
		CD4006B
		CD4060B
		CD4556B
		CD4008B
		CD4063B
		CD4585B
		CD4014B
		CD4067B*
		CD4724B
		CD4015B
		CD4076B
		CD14538B
		CD4017B
		CD4089B
		CD40100B
		CD4018B
		CD4094B
		CD40101B
		CD4020B
		CD4097B*
		CD40102B
		CD4021B
		CD4099B
		CD40103B
		CD4022B
		CD4508B
		CD40104B
		CD4024B
		CD4510B
		CD40105B
		CD4026B
		CD4511B*
		CD40108B
		CD4028B
		CD4512B
		CD40110B*
		CD4029B
		CD4514B
		CD40160B
		CD4031B*
		CD4515B
		CD40161B
		CD4033B
		CD4516B
		CD40162B
		CD4034B
		CD4517B
		CD40163B
		CD4035B
		CD4518B
		CD40181B
		CD4040B
		CD4520B
		CD40182B
		CD4046B*
		CD4527B
		CD40192B
		CD4051B*
		CD4532B
		CD40193B
		CD4052B*
		CD4536B
		CD40194B
		CD4053B*
		CD4555B
		CD40208B

* Indicates type for which, because of design requirements, one or more static characteristics differ from the standardized data. These differences are defined in separate DC Electrical Characteristics charts.

Radiation Resistant CD4000-Series

Harris radiation hardened CD4000-series CMOS integrated circuits tested to withstand total ionizing radiation dosages of 1×10^5 rads (Si) — R-suffix types, and 1×10^6 rads (Si) — H-suffix types. These radiation tolerances are achieved by special process controls imposed during wafer fabrication.

Harris radiation hardened types may be screened to Mil-M-38510 Class S and to level /MS. The specified levels of radiation resistance are verified per Table V group E subgroup 2 of Method 5005 and tested according to Method 1019 of Mil-Std-883. Four electrically good packaged samples from each wafer, one from each quadrant, are exposed in a Cobalt 60 source for a time period corresponding to the specified total dose. The samples are then electrically tested within one hour after exposure for threshold voltage, threshold voltage delta, I_{DD} leakage current, and functionality. Propagation delay is also measured for 38510 tested product.

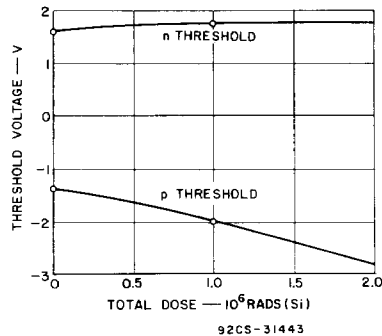

TYPICAL THRESHOLD VOLTAGE VARIATIONS OF HARRIS MEGARAD CD4000-SERIES CMOS INTEGRATED CIRCUITS AS A FUNCTION OF TOTAL DOSE GAMMA RADIATION

RADIATION RESISTANT CD4000-SERIES CMOS ICs

Post Radiation Test Criteria — Maximum Limits for I_{DD} , ($V_{DD} = 18V$ for B-Series Types or $15V$ for A-Series Types)

TYPE	I_{DD} (MAX) μA	TYPE	I_{DD} (MAX) μA	TYPE	I_{DD} (MAX) μA	TYPE	I_{DD} (MAX) μA
CD4000	2.5	CD4040	25	CD4078	2.5	CD4555	25
CD4001	2.5	CD4041	7.5	CD4081	2.5	CD4556	25
CD4002	2.5	CD4042	7.5	CD4082	2.5	CD4585	25
CD4006	25	CD4043	7.5	CD4085	2.5	CD4724	25
CD4007	2.5	CD4044	7.5	CD4086	2.5	CD40100	25
CD4008	25	CD4046	25	CD4089	25	CD40101	25
CD4009	7.5	CD4047	25	CD4093	7.5	CD40102	25
CD4010	7.5	CD4048	7.5	CD4094	25	CD40103	25
CD4011	2.5	CD4049	7.5	CD4095	7.5	CD40104	25
CD4012	2.5	CD4050	7.5	CD4096	7.5	CD40105	25
CD4013	7.5	CD4051	25	CD4097	25	CD40106	7.5
CD4014	25	CD4052	25	CD4098	7.5	CD40107	7.5
CD4015	25	CD4053	25	CD4099	25	CD40108	25
CD4016	2.5	CD4060	25	CD4502	7.5	CD40109*	7.5
CD4017	25	CD4063	25	CD4503	7.5	CD40147	25
CD4018	25	CD4066	2.5	CD4504	7.5	CD40160	25
CD4019	7.5	CD4067	25	CD4508	25	CD40161	25
CD4020	25	CD4068	7.5	CD4510	25	CD40162	25
CD4021	25	CD4069	2.5	CD4511	25	CD40163	25
CD4022	25	CD4070	2.5	CD4512	25	CD40174	7.5
CD4023	2.5	CD4071	2.5	CD4514	25	CD40175	7.5
CD4024	25	CD4072	2.5	CD4515	25	CD40181	25
CD4025	2.5	CD4073	2.5	CD4516	25	CD40182	25
CD4026	25	CD4075	2.5	CD4517	25	CD40192	25
CD4027	7.5	CD4076	25	CD4518	25	CD40193	25
CD4028	25	CD4077	2.5	CD4520	25	CD40194	25
CD4029	25			CD4527	25	CD40208	25
CD4030	7.5			CD4532	25	CD40257	7.5
CD4031	25			CD4536	25		
CD4033	25						
CD4034	25						
CD4035	25						

Post Radiation Threshold Voltage Test Criteria ($V_{DD} = 10V$; $I = \text{Constant } 10\mu A$)

N Threshold = 0.2V min

*P Threshold = 3.5V max CD40109 and 40106

P Threshold = 2.8V max

ΔP Threshold = 1.0V max

ΔN Threshold = 1.0V max

Radiation Hardened High Reliability ICs

Radiation Hardness Assurance Testing

CD4000-Series Total Dose Testing Procedures

- **Class S Wafer Sampling**
 - ▶ Test Four Samples (High-Rel Visual Rejects)
 - ▶ One From Each Quadrant of Wafer
 - ▶ Reject If Any One Sample Fails
- **Class B Inspection Lot Sampling**
 - ▶ LT PD = 20, 11/0
18/1

CD4000-SERIES POST RADIATION TESTS

SYMBOL	CHARACTERISTIC	JAN LIMIT	NONJAN LIMIT	VOLTAGE
V _{TN}	N Threshold Voltage	0.3V Min	0.2V Min	10V
V _{TP}	P Threshold Voltage	2.8V Max	2.8V Max	10V
ΔV _T	Delta Threshold Voltage	1.4V Max	1.0V Max	10V
I _{SS}	Quiescent Current	100 x Max	100 x Max	18V
	CD4000B-Series	Pre-Rad Value	Pre-Rad Value	
T _{PLH} , T _{PHL}	Propagation Delay	1.35 x Max Pre-Rad Value		5V*

* Worst case test condition

Radiation Resistant CD4000 Series

SCREENING LEVELS FOR HARRIS HIGH RELIABILITY RADIATION RESISTANT CD4000-SERIES CMOS ICs

SCREENING LEVELS	APPLICATION	DESCRIPTION
PACKAGED DEVICES (D, F, K OR J SUFFIX)		
/MSR /MSH	Aerospace and Missiles	For devices intended for use where maintenance and replacement are difficult and reliability is imperative
CHIPS (H SUFFIX)		
/SR /SH	Aerospace and Missiles	For hybrid applications where maintenance and replacement are extremely difficult and reliability is imperative

CD4000-Series CMOS ICs
Transient Radiation Resistance

Samples of CD4000-series devices representing all levels of circuit complexity have been characterized for transient radiation effects. The data indicate the ranges of occurrence of upset, latchup and survivability as a function of radiation dose rate.

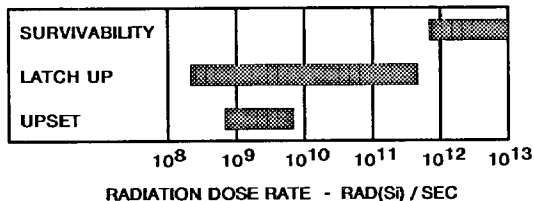

EFFECTS OF TRANSIENT RADIATION (10^6 RADS (Si) ON CD4000-SERIES INTEGRATED CIRCUITS (ALUMINUM GATE CMOS ON BULK SILICON)

Latchup

Latchup occurs because of the presence of inherent bipolar SCR structures in bulk CMOS devices. In normal operation, the parasitic bipolar SCR remains inactive. The device is said to be in the latchup state when the parasitic SCR structures become activated, thereby creating a low impedance path from VDD to VSS. In the "ON" condition, the SCR can conduct heavily at low voltages. Latchup may be induced by the resultant photocurrents of high intensity transient ionizing radiation or by applying excessive voltage. Once turned on, the SCR can be rendered dormant again only by removing the power supply. Burn-out of the device may result if the current is not limited in some way.

The region of occurrence of the latch condition in CMOS ICs under high intensity transient radiation is quite wide. Only two known device types latch below the 1×10^9 RAD (Si)/s level. A significant number of device types do not latch above dose rates of 1×10^{11} RADs (Si)/s.

Latchup Protection

Latchup protection in bulk CMOS devices can be achieved by taking advantage of the effects of neutron irradiation. Neutron irradiation will reduce minority-carrier lifetime, which, in turn attenuates the current gains, or betas, of bipolar transistors. To turn on the SCR structure of CMOS devices, it is necessary for the beta product of its bipolar transistors are majority-carrier devices, normal CMOS performance is generally unaffected by neutron irradiation. Therefore, neutron irradiation is a suitable method for precluding latchup in CMOS devices. In addition, neutron-irradiated CMOS devices are less susceptible to logic upset due to transient radiation.

Neutron-Irradiated CMOS

Harris offers custom CD4000-series devices which are made from wafers that are exposed to a neutron fluence of approximately 1×10^{14} n/cm². After neutron irradiation, wafers can be assembled and screened to all requirements of the Harris level product.

Survivability

Survivability level is the maximum transient-radiation level at which damage does not occur. Above this level photocurrents are created to the extent that excessive dissipation is caused, resulting in permanent damage to the device.

Standard DC Electrical Characteristics

Standard "B" Series Devices

The following table contains electrical characteristics for devices. These parameters are 100% tested except for all CD400B-series standard output CMOS where indicated.

Static Electrical Parameters	Conditions			Limits at Indicated Temperatures						Units	Notes
				-55°C		+25°C		+125°C			
	V _O	V _{IN}	V _{DD}	Min.	Max.	Min.	Max.	Min.	Max.		
Functional Test*	—	—	—	—	—	—	—	—	—		4
Quiescent device current I _{DD}	—	0,5	5	—	0.25*	—	0.25*	—	7.5*	μA	1
SSI Types	—	0,10	10	—	0.5*	—	0.5*	—	15*		
See Classification Chart	—	0,15	15	—	1*	—	1*	—	30*		
	—	0,20	20	—	5	—	5	—	150		
MSI-1	—	0,5	5	—	1*	—	1*	—	30*	μA	1, 2
See Classification Chart	—	0,10	10	—	2*	—	2*	—	60*		
	—	0,15	15	—	4*	—	4*	—	120*		
	—	0,20	20	—	20	—	20	—	600		
MSI-2	—	0,5	5	—	5*	—	5*	—	150*	μA	1
See Classification Chart	—	0,10	10	—	10*	—	10*	—	300*		
	—	0,15	15	—	20*	—	20*	—	600*		
	—	0,20	20	—	100	—	100	—	3000		
Output low drive current I _{OL} min.	0.4	0,5	5	0.64*	—	0.51	—	0.36*	—	mA	
	0.5	0,10	10	1.6*	—	1.3	—	0.9*	—		
	1.5	0,15	15	4.2*	—	3.4	—	2.4*	—		
Output high drive current I _{OH} min.	4.6	0,5	5	-0.64	—	-0.51	—	-0.36*	—	mA	
	2.5	0,5	5	-2.0	—	-1.6	—	-1.15*	—		
	9.5	0,10	10	-1.6	—	-1.3	—	-0.9*	—		
	13.5	0,15	15	-4.2	—	-3.4	—	-2.4*	—		
Output voltage low-level V _{OL} max.	—	0,5	5	—	0.05*	—	0.05*	—	0.05*	V	
	—	0,10	10	—	0.05*	—	0.05*	—	0.05*		
	—	0,15	15	—	0.05	—	0.05	—	0.05		
Output voltage high-level V _{OH} min.	—	0,5	5	4.95*	—	4.95*	—	4.95	—	V	
	—	0,10	10	9.95*	—	9.95*	—	9.95	—		
	—	0,15	15	14.95	—	14.95	—	14.95	—		
Input low voltage V _{IL} max.	4.5	—	5	—	1.5	—	1.5	—	1.5	V	
Buffered (B)	9	—	10	—	3*	—	3	—	3		
	13.5	—	15	—	4	—	4	—	4		
Unbuffered (UB)	4.5	—	5	—	1*	—	1	—	1	V	
	9	—	10	—	2	—	2	—	2		
	13.5	—	15	—	2.5	—	2.5	—	2.5		
Input high voltage V _{IH} min.	0.5, 4.5	—	5	3.5	—	3.5	—	3.5	—	V	
Buffered (B)	1, 9	—	10	7	—	7	—	7	—		
	1.5, 13.5	—	15	11	—	11	—	11	—		
Unbuffered (UB)	0.5, 4.5	—	5	4	—	4	—	4	—	V	
	1, 9	—	10	8	—	8	—	8	—		
	1.5, 13.5	—	15	12.5	—	12.5	—	12.5	—		
Input current I _{IN}	—	0,20	20	—	± 0.1	—	± 0.1	—	± 1	μA	1
3-state output leakage current I _{OUT}	0,20	0,20	20	—	± 0.4	—	± 0.4	—	± 12	μA	1, 3

* These parameters are controlled via design or process parameters and are not directly tested. These parameters are characterized upon initial design release and upon design changes which would affect these characteristics.

NOTES:

- At -55°C test is performed with V_{DD} of 18V.
- CD4047B - Maximum DC supply voltage V_{DD} is 13V for radiation hardened version of this type when operating with RC network.
- For applicable devices only.
- At 25°C V_{IN} = 0 - 20V, V_{DD} = 20V; 125°C V_{IN} = 0 - 18V, V_{DD} = 18V; and at -55°C V_{IN} = 0 - 3V, V_{DD} = 3V.

Non-Standard DC Electrical Characteristics

Non-Standard "B" Series Devices

The table below indicates all devices which are considered to be non-standard. Non-standard devices are types such as bilateral switches (CD4066B), multiplexers (CD4051B), special sink or source currents (CD4049UB, CD4050B), and open drain buffer/drivers (CD40107B) which exhibit non-standard outputs or special parameters. This table shows the

100% electrical tests that are performed on these specialized devices. These tests take the place of corresponding parameters in the Standard Electrical Characteristics table. For the types listed with RON tests, drive current and output voltage tests should be deleted from the Standard Electrical Characteristics table.

Static Electrical Parameters	Conditions			Limits at Indicated Temperatures				Units
				-55°C	+25°C		+125°C	
	V _O	V _{IN}	V _{DD}	Min./Max.	Min.	Max.	Min./Max.	
CD4009UB, CD4010B								
Output low drive current I _{OL} min.	0.4	0.5	4.5	3.2*	2.6*	—	1.8*	mA
	0.4	0.5	5	3.75*	3	—	2.1*	
	0.5	0.10	10	10.0*	8	—	5.6*	
	1.5	0.15	15	30.0*	24	—	16.0*	
Output high drive current I _{OH} min.	4.6	0.5	5	-0.25*	-0.2	—	-0.15*	mA
	2.5	0.5	5	-1.0*	-0.8	—	-0.58*	
	9.5	0.10	10	-0.55*	-0.45	—	-0.33*	
	13.5	0.15	15	-1.65*	-1.5	—	-1.1*	
CD4016B								
Control Input voltage low V _{IL} max.	V _{IS} =V _{SS} , V _{OS} =V _{DD}		5	0.9	—	0.7	0.4	V
	V _{IS} =V _{DD} , V _{OS} =V _{SS}		10	0.9*	—	0.7	0.4*	
	I _{IS} < 10μA		15	0.9	—	0.7	0.4	
Control Input voltage high V _{IH} min.	—		5	3.5	3.5	—	3.5	V
	—		10	7.0*	7.0*	—	7.0*	
	—		15	11.0	11.0	—	11.0	
On-state resistance R _{ON} max. R _L = 10k returned to V _{DD} -V _{SS} /2	V _{IS} =V _{DD} or V _{SS}		10	600	—	660	960	ohms
	V _{IS} =4.75 or 5.75		10	1870	—	2000	2600	
	V _{IS} =V _{DD} or V _{SS}		15	360	—	400	600	
	V _{IS} =7.25 or 7.75		15	775	—	850	1230	
CD4031B								
Output low drive current I _{OL} min. Q	0.4	0.5	5	2.56*	2.04	—	1.44*	mA
	0.5	0.10	10	6.4*	5.2	—	3.6*	
	1.5	0.15	15	16.8*	13.6	—	9.6*	
Q̄, Q', CLd	0.4	0.5	5	0.64*	0.51	—	0.36*	mA
	0.5	0.10	10	1.6*	1.3	—	0.9*	
	1.5	0.15	15	4.2*	3.4	—	2.4*	
Output high drive current I _{OH} min. Q, Q̄, Q', CLd	4.6	0.5	5	-0.64*	-0.51	—	-0.36*	mA
	2.5	0.5	5	-2.0*	-1.6	—	-1.15*	
	9.5	0.10	10	-1.6*	-1.3	—	-0.9*	
	13.5	0.15	15	-4.2*	-3.4	—	-2.4*	
CD4041UB								
Output low drive current I _{OL} min.	0.4	0.5	5	2.1*	1.6	—	1.2*	mA
	0.5	0.10	10	6.25*	5	—	3.5*	
	1.5	0.15	15	24*	19	—	13*	
Output high drive current I _{OH} min.	4.6	0.5	5	-2.1*	-1.6	—	-1.2*	mA
	2.5	0.5	5	-8.4*	-6.4	—	-4.6*	
	9.5	0.10	10	-6.25*	-5.0	—	-3.5*	
	13.5	0.15	15	-24*	-19	—	-13*	

Limits with black dots (*) are tested 100%.

- These parameters are controlled via design or process parameters and are not directly tested. These parameters are characterized upon initial design release and upon design changes which would affect these characteristics.

High Reliability CD4000B-Series CMOS ICs

Non-Standard DC Electrical Characteristics (Continued)

Static Electrical Parameters	Conditions			Limits at Indicated Temperatures				Units
				-55°C	+25°C		+125°C	
	V _O	V _{IN}	V _{DD}	Min./Max.	Min.	Max.	Min./Max.	
CD4046B								
Zener diode voltage (V _Z)	I _Z = 50 μA			—	4.45*	6.5*	—	V
Quiescent leakage phase comparator pin 14 open pin 5 = V _{DD}	—	0,5	5	0.2	—	0.2	—	mA
	—	0,10	10	1.0	—	1.0	—	
	—	0,15	15	1.5	—	1.5	—	
	—	0,20	20	4.0	—	4.0*	—	
Quiescent leakage phase comparator pin 14 = V _{SS} or V _{DD} pin 5 = V _{DD}	—	0,5	5	20	—	20	—	μA
	—	0,10	10	40	—	40	—	
	—	0,15	15	80	—	80	—	
	—	0,20	20	160	—	160*	—	
CD4049UB, CD4050B								
Output low drive current I _{OL} min.	0.4	0,5	4.5	3.3	2.6*	—	1.8	mA
	0.4	0,5	5	4.0	3.2*	—	2.4	
	0.5	0,10	10	10	8.0*	—	5.6	
	1.5	0,15	15	26	24*	—	18	
Output high drive current I _{OH} min.	4.6	0,5	5	-0.81	-0.8*	—	-0.48	mA
	2.5	0,5	5	-2.6	-3.2*	—	-1.55	
	9.5	0,10	10	-2.0	-1.8*	—	-1.18	
	13.5	0,15	15	-5.2	-6.0*	—	-3.1	
CD4051B, CD4052B, CD4053B, CD4067B, CD4097B								
On-state resistance R _{ON} max.	R _L = 10k returned to V _{DD} -V _{SS} /2		5	800	—	1050*	1300*	ohms
	V _{IS} = V _{SS} to V _{DD}		10	310	—	400*	500*	
			15	200	—	240*	320*	
Input voltage low V _{IL} max.	V _{EE} = V _{SS}		5	1.5*	—	1.5*	1.5*	Volts
	R _L = 1k to V _{SS}		10	3.0	—	3.0	3.0	
	I _{IS} < 2 μA		15	4.0*	—	4.0*	4.0*	
Input voltage high V _{IH} min.	V _{EE} = V _{SS}		5	3.5*	3.5*	—	3.5*	Volts
	R _L = 1k to V _{SS}		10	7.0	7.0	—	7.0	
	I _{IS} < 2 μA		15	11.0*	11.0*	—	11.0*	
Off channel leakage current Any channel off max.	V _{SS} -V	V _{EE} -V						nA
	0	0	18	± 100*	—	± 100*	± 1000*	
All channels (common out/in) off max.								

- * These parameters are controlled via design or process parameters and are not directly tested. These parameters are characterized upon initial design release and upon design changes which would affect these characteristics.

High Reliability CD4000B-Series CMOS ICs

Non-Standard DC Electrical Characteristics (Continued)

Static Electrical Parameters	Conditions			Limits at Indicated Temperatures				Units
				-55°C	+25°C		+125°C	
	V _O	V _{IN}	V _{DD}	Min./Max.	Min.	Max.	Min./Max.	
CD4066B								
On-state resistance R _{ON} max.	R _L = 10k returned		5	800*	—	1050*	1300*	ohms
	to V _{DD} -V _{SS} /2		10	310*	—	400*	550*	
	V _{IS} = V _{SS} to V _{DD}		15	200*	—	240*	320*	
Control Input Voltage Low V _{ILC} max.	V _{IS} = V _{SS} , V _{OS} = V _{DD}		5	1.0*	—	1.0*	1.0*	Volts
	V _{IS} = V _{DD} , V _{OS} = V _{SS}		10	2.0	—	2.0	2.0	
	I _{IS} < 10 μA		15	2.0*	—	2.0*	2.0*	
Control Input Voltage High V _{IHC} min.	—		5	3.5*	3.5*	—	3.5*	Volts
			10	7.0	7.0	—	7.0	
			15	11.0*	11.0*	—	11.0*	
Input output leakage current (switch off) Effective off resistance V _C = V _{SS}	0	0	18	± 100	—	± 100	± 1000	nA
CD4093B								
Positive Trigger Threshold Voltage V _P min.	—	a	5	2.2*	2.2*	—	2.2*	V
	—	a	10	4.6	4.6	—	4.6	
	—	a	15	6.8*	6.8*	—	6.8*	
	—	b	5	2.6*	2.6*	—	2.6*	
	—	b	10	5.6	5.6	—	5.6	
	—	b	15	6.3	6.3	—	6.3	
	—	b	15	6.3	6.3	—	6.3	
V _P max.	—	a	5	3.6*	—	3.6*	3.6*	V
	—	a	10	7.1	—	7.1	7.1	
	—	a	15	10.8*	—	10.8*	10.8*	
	—	b	5	4*	—	4*	4*	
	—	b	10	8.2	—	8.2	8.2	
	—	b	15	12.7	—	12.7	12.7	
	—	b	15	12.7	—	12.7	12.7	
Negative Trigger Threshold Voltage V _N min.	—	a	5	0.9*	0.9*	—	0.9*	V
	—	a	10	2.5	2.5	—	2.5	
	—	a	15	4*	4*	—	4*	
	—	b	5	1.4*	1.4*	—	1.4*	
	—	b	10	3.4	3.4	—	3.4	
	—	b	15	4.8	4.8	—	4.8	
	—	b	15	4.8	4.8	—	4.8	
V _N max.	—	a	5	2.8*	—	2.8*	2.8*	V
	—	a	10	5.2	—	5.2	5.2	
	—	a	15	7.4*	—	7.4*	7.4*	
	—	b	5	3.2*	—	3.2*	3.2*	
	—	b	10	6.6	—	6.6	6.6	
	—	b	15	9.6	—	9.6	9.6	
	—	b	15	9.6	—	9.6	9.6	
Hysteresis Voltage V _H min.	—	a	5	0.3*	0.3*	—	0.3*	V
	—	a	10	1.2	1.2	—	1.2	
	—	a	15	1.6*	1.6*	—	1.6*	
	—	b	5	0.3*	0.3*	—	0.3*	
	—	b	10	1.2	1.2	—	1.2	
	—	b	15	1.6	1.6	—	1.6	
	—	b	15	1.6	1.6	—	1.6	
V _H max.	—	a	5	1.6	—	1.6*	1.6*	V
	—	a	10	3.4	—	3.4	3.4	
	—	a	15	5*	—	5*	5*	
	—	b	5	1.6	—	1.6*	1.6*	
	—	b	10	3.4	—	3.4	3.4	
	—	b	15	5	—	5	5	
	—	b	15	5	—	5	5	

* Input on terminals 1, 5, 8, 12, or 2, 6, 9, 13; other inputs to V_{DD}.

† Input on terminals 1 and 2, 5 and 6, 8 and 9, or 12 and 13; other inputs to V_{DD}.

• These parameters are controlled via design or process parameters and are not directly tested. These parameters are characterized upon initial design release and upon design changes which would affect these characteristics.

High Reliability CD400B-Series CMOS ICs

Non-Standard DC Electrical Characteristics (Continued)

Static Electrical Parameters	Conditions			Limits at Indicated Temperatures				Units		
				-55°C	+25°C		+125°C			
	V_O	V_{IN}	V_{DD}	Min./Max.	Min.	Max.	Min./Max.			
CD4502B										
Output low drive current	0.4	0.5	5	3.84	3.06*	—	2.16	mA		
I_{OL} min.	0.5	0.10	10	9.6	7.8*	—	5.4			
	1.5	0.15	15	25.2	20.4*	—	14.4			
CD4503B										
Output low drive current	0.4	0	5	2.6	2.1*	—	1.3	mA		
I_{OL} min.	0.5	0	10	6.5	5.5*	—	3.8			
	1.5	0	15	19.2	16.1*	—	11.2			
Output high drive current	4.6	5	5	-1.2	-1.02*	—	-0.7	mA		
I_{OH} min.	2.5	5	5	-5.8	-4.8*	—	-3.0			
	9.5	10	10	-3.1	-2.6*	—	-1.8			
	13.5	15	15	-8.2	-6.8*	—	-4.8			
CD4504B										
Input low voltage V_{IL} max.	V_{CC}	5	1	—	10	0.8	—	0.8	V	
	TTL-CMOS	5	1	—	15	0.8*	—	0.8*		
	CMOS-CMOS	5	1	—	10	1.5*	—	1.5*		
	CMOS-CMOS	5	1.5	—	15	1.5	—	1.5		
	CMOS-CMOS	10	1.5	—	15	3*	—	3*		
Input high voltage V_{IH} min.	V_{CC}	5	9	—	10	2	2	—	V	
	TTL-CMOS	5	13.5	—	15	2*	2*	—		
	CMOS-CMOS	5	9	—	10	3.5*	3.5*	—		
	CMOS-CMOS	5	13.5	—	15	3.5	3.5	—		
	CMOS-CMOS	10	13.5	—	15	7*	7*	—		
CD4511B										
Output voltage high-level	—	0.5	5	4	4.1	—	4.2	V		
V_{OH} min.	—	0.10	10	9	9.1	—	9.2			
	—	0.15	15	14*	14.1*	—	14.2*			
Output drive voltage high level V_{OH} min.	I_{OH} (mA)	0	—	—	5	4.0	4.10	—	4.20	V
		5	—	—	5	—	—	—	—	
		10	—	—	5	3.80	3.90	—	3.90	
		15	—	—	5	—	—	—	3.50	
		20	—	—	5	3.55	3.40*	—	—	
		25	—	—	5	3.40	3.10	—	—	
		0	—	—	10	9.0	9.10	—	9.20	V
		5	—	—	10	—	—	—	—	
		10	—	—	10	8.85	9.0	—	9.0	
		15	—	—	10	—	—	—	—	
		20	—	—	10	8.70	8.60*	—	8.40	
		25	—	—	10	8.60	8.30	—	—	
		0	—	—	15	14.0	14.10	—	14.20	V
		5	—	—	15	—	—	—	—	
		10	—	—	15	13.90	14.0	—	14.0	
	15	—	—	15	—	—	—	—		
	20	—	—	15	13.75	13.70*	—	13.50		
	25	—	—	15	13.65	13.50	—	—		

* These parameters are controlled via design or process parameters and are not directly tested. These parameters are characterized upon initial design release and upon design changes which would affect these characteristics.

Non-Standard DC Electrical Characteristics (Continued)

Static Electrical Parameters	Conditions			Limits at Indicated Temperatures				Units
				-55°C	+25°C		+125°C	
	V _O	V _{IN}	V _{DD}	Min./Max.	Min.	Max.	Min./Max.	
CD40106B								
Positive trigger threshold voltage V _P min.	—	—	5	2.2•	2.2•	—	2.2•	V
	—	—	10	4.6•	4.6•	—	4.6•	
	—	—	15	6.8•	6.8•	—	6.8•	
V _P max.	—	—	5	3.6•	—	3.6•	3.6•	V
	—	—	10	7.1•	—	7.1•	7.1•	
	—	—	15	10.8•	—	10.8•	10.8•	
Negative trigger threshold voltage V _N min.	—	—	5	0.9•	0.9•	—	0.9•	V
	—	—	10	2.5•	—	2.5•	2.5•	
	—	—	15	4•	—	4•	4•	
V _N max.	—	—	5	2.8•	—	2.8•	2.8•	V
	—	—	10	5.2•	—	5.2•	5.2•	
	—	—	15	7.4•	—	7.4•	7.4•	
Hysteresis voltage V _H min.	—	—	5	0.3•	0.3•	—	0.3•	V
	—	—	10	1.2•	—	1.2•	1.2•	
	—	—	15	1.6•	—	1.6•	1.6•	
V _H max.	—	—	5	1.6•	—	1.6•	1.6•	V
	—	—	10	3.4•	—	3.4•	3.4•	
	—	—	15	5•	—	5•	5•	
CD40107B								
Output low current I _{OL} min.	0.4	0.5	5	21	16•	—	12	mA
	1	0.5	5	44	34•	—	25	
	0.5	0.10	10	49	37•	—	28	
	1	0.10	10	89	68•	—	51	
	0.5	0.15	15	66	50•	—	38	
Output high current I _{OH} min.	NO INTERNAL PULL-UP DEVICE							
Input low voltage V _{IL} max. *	4.5	—	5	1.5•	—	1.5•	1.5•	V
	9	—	10	3	—	3	3	
	13.5	—	15	4•	—	4•	4•	
Input high voltage V _{IH} min. *	0.5, 4.5	—	5	3.5•	3.5•	—	3.5•	V
	1.9	—	10	7	7	—	7	
	1.5, 13.5	—	15	11•	11•	—	11•	

* Measured with external pull-up resistor, R_L = 10kΩ to V_{DD}

• These parameters are controlled via design or process parameters and are not directly tested. These parameters are characterized upon initial design release and upon design changes which would affect these characteristics.

† At -55°C test is performed with V_{DD} of 18V

High Reliability CD4000B-Series CMOS ICs

Non-Standard DC Electrical Characteristics (Continued)

Static Electrical Parameters	Conditions			Limits at Indicated Temperatures				Units
				-55°C	+25°C		+125°C	
	V _O	V _{CC}	V _{DD}	Min./Max.	Min.	Max.	Min./Max.	
CD40109B								
Input low voltage V _{IL} max.	1,9 1.5, 13.5	5 10	10 15	1.5• 3•	— —	1.5• 3•	1.5• 3•	V
Input high voltage V _{IH} max.	1,9 1.5, 13.5	5 10	10 15	3.5• 7•	3.5• 7•	— —	3.5• 7•	V
CD40110B								
Output Voltage Low-Level V _{OL} max.	I _{OH}	V _{OH}	V _{IN}	V _{DD}				
	—	—	0,5	5	0.05	—	0.05	0.05
	—	—	0,10	10	0.05	—	0.05	0.05
High-Level V _{OH} min.	—	—	0,5	5	—	—	—	—
	—	—	0,10	10	—	—	—	—
	—	—	0,15	15	—	—	—	—
7-Segment Outputs Output Drive Voltage, High V _{OH} min.	■	—	—	5	3.9	3.9	—	4
	-5	—	—	5	3.65	3.7	—	3.7
	-10	—	—	5	3.55	3.65	—	3.65
	-15	—	—	5	3.5	3.6	—	3.5
	-20	—	—	5	3.45	3.45•	—	3.35
	-25	—	—	5	3.4	3.4	—	3.3
	■	—	—	10	8.75	8.75	—	8.85
	-5	—	—	10	8.45	8.55	—	8.55
	-10	—	—	10	8.42	8.5	—	8.5
	-15	—	—	10	8.4	8.47	—	8.47
	-20	—	—	10	8.4	8.45•	—	8.40
	-25	—	—	10	8.3	8.3	—	8.25
	■	—	—	15	13.8	13.8	—	13.9
	-5	—	—	15	13.65	13.75	—	13.75
	-10	—	—	15	13.6	13.72	—	13.72
-15	—	—	15	13.6	13.7	—	13.7	
-20	—	—	15	13.6	13.65•	—	13.6	
-25	—	—	15	13.3	13.3	—	13.25	
7-Segment Outputs Output Low (Sink) Current I _{OL} min.	—	0.4	0,5	5	1.28	1•	—	0.72
	—	0.5	0,10	10	3.2	2.6•	—	1.8
	—	1.5	0,15	15	8.4	6.8•	—	4.8

• These parameters are controlled via design or process parameters and are not directly tested. These parameters are characterized upon initial design release and upon design changes which would affect these characteristics.

■ 0 (10μA)

High Reliability CD400B-Series CMOS ICs

Switching Characteristics at 25°C

The chart below lists all Harris high reliability CD400B-series devices and shows which switching parameters are 100% tested at final electrical and Group A. In general, Harris tests propagation delay, transition time, and maximum clock frequency at 5V where applicable.

TYPE	CONDITIONS* V _{DD} = 5V, C _L = 50pF	PROP DELAY (ns)	TRANS. TIME (ns)	MAX CLOCK INPUT FREQ. (MHz)
CD4000B	-	250	200	-
CD4001B	-	250	200	-
CD4002B	-	250	200	-
CD4006B	-	400	200	2.5
CD4007UB	-	110	200	-
CD4008B	Sum In to Sum Out	800	200	-
	Carry In to Sum Out	740	-	-
	Sum In to Carry Out	400	-	-
	Carry In to Carry Out	200	-	-
CD4009UB	-	140*	350*	-
	-	60▲	70▲	-
CD4010B	-	200*	350*	-
	-	130▲	70▲	-
CD4011B	-	250	200	-
CD4012B	-	250	200	-
CD4013B	Clock to Q or \bar{Q}	300	200	3.5
	Set to Q or Reset to \bar{Q}	300*	-	-
	Set to \bar{Q} or Reset to Q	400▲	-	-
CD4014B	-	320	200	3
CD4015B	Clock to Q	320	200	3
	Reset to Q	400▲	-	-
CD4016B	Sig. Input to Sig. Output	100	-	-
	Turn On	70	-	-
CD4017B	Clock to Out	650	200	2.5
	Clock to Carry Out	600	-	-
	Reset to Out	530	-	-
CD4018B	Clock to Q	400	200	3
	Preset/Reset to Q	550	-	-
CD4019B	-	300	200	-
CD4020B	ϕ to Q1	360	200	3.5
	Qn to Qn + 1	330	-	-
	Reset to Q	280▲	-	-
CD4021B	-	320	200	3
CD4022B	Clock to Carry Out	600	200	2.5
	Clock to Decode Out	650	-	-
	Reset to Output	530	-	-
CD4023B	-	250	200	-

* t_{TLH} or t_{PLH}

▲ t_{THL} or t_{PHL}

Harris warrants all other switching parameters shown in the appropriate commercial data sheet. Harris high reliability switching tests are performed on a one-input to one-output basis only.

TYPE	CONDITIONS* V _{DD} = 5V, C _L = 50pF	PROP DELAY (ns)	TRANS. TIME (ns)	MAX CLOCK INPUT FREQ. (MHz)
CD4024B	ϕ to Q1	360	200	3.5
	Qn to Qn + 1	330	-	-
	Reset to Q	280▲	-	-
CD4025B	-	250	200	-
CD4026B	Clock to Carry Out	500	200	2.5
	Clock to Decode Out	700	-	-
	Reset to Carry Out	550*	-	-
	Reset to Decode Out	600	-	-
CD4027B	Clock to Q or \bar{Q}	300	200	3.5
	Set to Q or Reset to \bar{Q}	300*	-	-
	Set to \bar{Q} or Reset to Q	400▲	-	-
CD4028B	-	350	200	-
CD4029B	Q Output	500	200	2
	Carry Output	560	-	-
	Preset Enable to Q	470	-	-
	Preset Enable to Carry Out	640	-	-
	Carry Input to Carry Out	340	-	-
CD4030B	-	280	200	-
CD4031B	Clock to \bar{Q}	500	200	2
	Clock to Q	500*	-	-
	Clock to Q	380▲	-	-
	Clock to Q'	380	-	-
	Clock to CL _D	200	-	-
CD4033B	Clock to Carry Out	500	200	2.5
	Clock to Decode Out	700	-	-
	Reset to Carry Out	550*	-	-
	Reset to Decode Out	600	-	-
CD4034B	Parallel In to Parallel Out	700	200	2
	AE to "A" Out t _{PLZ} , t _{PZL} , t _{PHZ} , t _{PZH}	400	-	-
CD4035B	Clock to Q	500	200	2
	Reset to Q	460	-	-
CD4040B	ϕ to Q1	360	200	3.5
	Qn to Qn + 1	330	-	-
	Reset to Q	280▲	-	-
CD4041UB	-	120	80	-

High Reliability CD4000B-Series CMOS ICs

Switching Characteristics at 25°C

TYPE	CONDITIONS* V _{DD} = 5V, C _L = 50pF	PROP. DELAY (ns)	TRANS. TIME (ns)	MAX. CLOCK INPUT FREQ. (MHz)
CD4042B	Data In to Q	220	200	-
	Data In to \bar{Q}	300	-	-
	Clock to Q	450	-	-
	Clock to \bar{Q}	500	-	-
CD4043B, 44B	Set or Reset to Q	300	200	-
	Enable to Q - t _{PHZ} , t _{PZH}	230	-	-
	Enable to Q - t _{PLZ} , t _{PZL}	180	-	-
CD4046B	AC Coupled Signal Input Voltage Sensitivity (Peak to Peak) f _{IN} = 100kHz Sine Wave	360mV Max		
CD4047B	t _R to Q, \bar{Q}	1000	200	-
	Astable to Q, \bar{Q}	700	-	-
	Retrigger to Q, \bar{Q}	600	-	-
	Astable to Oscillator	400	-	-
	Reset to Q, \bar{Q}	500	-	-
CD4048B	Ka to Output	600	200	-
CD4049UB	-	120*	160*	-
	-	65▲	60▲	-
CD4050B	-	140*	160*	-
	-	110▲	60▲	-
CD4051B, 52B, 53B	Add to Signal Out	720	-	-
	Inhibit to Signal Out - Channel On	720	-	-
	Inhibit to Signal Out - Channel Off	450	-	-
CD4060B	Input Pulse Operation $\phi 1$ to Q4	740	200	3.5
	Qn to Qn = 1	200	-	-
	Reset Operation	360▲	-	-
CD4063B	Comparator Input to Output	1250	200	-
	Cascade Input to Output	1000	-	-
CD4066B	Signal Input to Signal Output R _L = 200k, V _C = V _{DD} , V _{SS} = GND, V _{IS} = Square Wave \approx 5V and t _r , t _f = 20ns	40	-	-
	t _{pdC} , t _{rC} , t _{fC} = 20ns, R _L = 1k & V _{IS} < 5V	70	-	-
CD4067B	Add or inhibit to Signal Out Channel On	650	-	-
	Signal In to Out	60	-	-
CD4068B	-	300	200	-
CD4070B	-	280	200	-

* t_{TLH} or t_{PLH}

▲ t_{THL} or t_{PHL}

TYPE	CONDITIONS* V _{DD} = 5V, C _L = 50pF	PROP. DELAY (ns)	TRANS. TIME (ns)	MAX. CLOCK INPUT FREQ. (MHz)
CD4071B, 72B, 73B, 75B	-	250	200	-
	Clock to Q	600	200	-
	-	280	200	-
	-	300	200	3
CD4081B, 82B	-	250	200	-
CD4085B, 86B	Data	450▲ 620*	200	-
	Inhibit	300▲	-	-
		500*	-	-
CD4089B	Clock to Out	300	200	1.2
	Clear to Out	760	-	-
	Cascade to Out	180	-	-
CD4093B	-	380	200	-
CD4094B	Clock to Serial Out Qs	600	200	1.25
	Clock to Serial Out Q's	460	-	-
	Clock to Parallel Out	840	-	-
	Strobe to Parallel Out	580	-	-
	Out Enable to Parallel Out, t _{PHZ} , t _{PZH}	280	-	-
	Out Enable to Parallel Out, t _{PLZ} , t _{PZL}	200	-	-
CD4095B, 96B	Clock to Output	500	200	3.5
	Set or Reset	300	-	-
CD4097B	Address or Inhibit to Sig. Out - Channel On	650	-	-
	Signal In to Out	60	-	-
CD4098B	Trigger to Q, \bar{Q}	500	200	-
CD4099B	Data to Output	400	200	-
CD4502B	Data or Inhibit Delay Time	380*	200*	-
		270▲	120▲	-
	Disable Delay Time - t _{PHZ}	120	-	-
	Disable Delay Time - t _{PZH}	220	-	-
Disable Delay Time - t _{PLZ} , t _{PZL}	250	-	-	
CD4503B	-	150*	90*	-
	-	110▲	70▲	-
	t _{PHZ} , t _{PZH}	140	-	-
	t _{PLZ} , t _{PZL}	180	-	-

High Reliability CD4000B-Series CMOS ICs

Switching Characteristics at 25°C

TYPE	CONDITIONS* V _{DD} = 5V, C _L = 50pF			PROP. DELAY (ns)	TRANS. TIME (ns)	MAX. CLOCK INPUT FREQ. (MHz)
	SHIFT MODE	V _{CC}	V _{DD}			
CD4504B	TTL to CMOS V _{DD} > V _{CC}	5	10	280▲	-	-
	CMOS to CMOS V _{DD} > V _{CC}	5	10	240▲	-	-
	CMOS to CMOS V _{CC} > V _{DD}	10	5	550▲	-	-
	TTL to CMOS V _{DD} > V _{CC}	5	10	280*	-	-
	CMOS to CMOS V _{DD} > V _{CC}	5	10	240*	-	-
	CMOS to CMOS V _{CC} > V _{DD}	10	5	400*	-	-
	All Modes t _{THL} , t _{PLH}	-	5	200	-	-
			10	100	-	-
CD4508B	Strobe In to Data Out			260	200	-
CD4510B	Clock to Q Output			400	200	2
	Preset or Reset to Q			420	-	-
	Clock to Carry Out			480	-	-
	Carry In to Carry Out			250	-	-
CD4511B	Data to Output			1040▲	310▲	-
	-			1320*	80*	-
CD4512B	Inhibit to Output			280	200	-
	"A" Select to Output			400	-	-
	Data to Output			360	-	-
	t _{PHZ} , t _{PZH}			120	-	-
CD4514B, 15B	Strobe or Data			970	200	-
	Inhibit			500	-	-
CD4516B	Clock to Q Output			400	200	2
	Preset or Reset to Q			420	-	-
	Clock to Carry Out			480	-	-
	Carry In to Carry Out			250	-	-
	Preset or Reset to Carry Out			640	-	-
CD4517B	Clock to Q16			400	200	3
CD4518B, 20B	Clock to Output			560	200	1.5
	Reset to Output			650▲	-	-
CD4527B	Clock to Out			300	200	1.2
	Clear to Out			760	-	-
	Cascade to Out			180	-	-
CD4532B	E ₁ to E _O , E ₁ to G _s			220	200	-
	D _n to Q _m			440	-	-
	D _n to G _s , E ₁ to Q _m			340	-	-

* t_{TLH} or t_{PLH}

▲ t_{THL} or t_{PLH}

TYPE	CONDITIONS* V _{DD} = 5V, C _L = 50pF	PROP. DELAY (ns)	TRANS. TIME (ns)	MAX. CLOCK INPUT FREQ. (MHz)
	Clock to Q1 8 Bypass Low	5000	-	-
	Clock to Q16	8000	-	-
	Reset to Q _n	6000▲	-	-
CD4555B, 56B	Select to Any Output	440	200	-
	Enable to Any Output	400	-	-
CD4585B	Comparator Inputs to Outputs	600	200	-
	Cascade Inputs to Outputs	400	-	-
CD4724B	Data to Outputs	400	200	-
	Write Disable to Output	400	-	-
	Reset to Output	350▲	-	-
	Address to Output	450	-	-
CD1438B	Trigger to Q, \bar{Q}	600	200	-
	Reset to Q or \bar{Q}	500	-	-
CD40100B	-	720	200	1
CD40101B	Data In to Output	700	200	-
	Inhibit In to Output	280	-	-
CD40102B, 103B	Clock to Output	600	200	0.7
	Carry In/Counter Enable to Output	400	-	-
	Asynchronous Preset Enable to Output	1300*	-	-
	Clear to Output	750▲	-	-
CD40104B	Clock to Q	440	200	3
	t _{PZH} , t _{PLZ} , t _{PZL}	160	-	-
	t _{PHZ}	90	-	-
CD40105B	Shift Out or Reset to Data Out Ready	370▲	200	1.5
	Shift In to Data In Ready	320▲	-	-
	3-State Control to Data Out t _{PZH}	280	-	-
	Ripple Thru Delay Input to Out t _{PLH}	4000*	-	-
CD40106B	-	280	200	-
CD40107B	R _L = 120Ω	200	100	-
CD40108B	Clock or Write Enable to Q	720	200	1.5
	Read or Write Address to Q	600	-	-
	Disable Delay Time t _{PZH} , t _{PHZ}	200	-	-
	Disable Delay Time t _{PZL} , t _{PLZ}	260	-	-

High Reliability CD4000B-Series CMOS ICs

Switching Characteristics at 25°C

TYPE	CONDITIONS* V _{DD} = 5V, C _L = 50pF				PROP. DELAY (ns)	TRANS. TIME (ns)	MAX. CLOCK INPUT FREQ. (MHz)	
CD40109B	Data Input to Output							
	SHIFT MODE	V _{CC}	V _{DD}					
								L-H
	L-H	5V	10V	260*	-	-		
	H-L	10V	5V	500▲	200	-		
	H-L	10V	5V	460*	-	-		
	3-State Disable Delay R _L = 1kΩ							
	t _{PHZ}	SHIFT MODE	V _{CC}	V _{DD}				
	t _{PHZ}	H-L	10V	5V	400	-	-	
	t _{PLZ}	L-H	5V	10V	740	-	-	
	t _{PLZ}	H-L	10V	5V	500	-	-	
	t _{PZH}	L-H	5V	10V	-	-	-	
	t _{PZH}	H-L	10V	5V	600	-	-	
	t _{PZL}	L-H	5V	10V	200	-	-	
t _{PZL}	H-L	10V	5V	400	-	-		
CD40110B	Clock to Carry or Borrow				600	-	1.0	
CD40147B	In-Phase Output				900	200	-	
CD40160B,	Clock to Q				400	200	2	
161B, 162B,	Clock to C _{OUT}				450	-	-	
163B	T _E to C _{OUT}				250	-	-	
	Clear to Q (CD40160B & CD 40161B only)				500▲	-	-	
CD40174B	Clock to Output				300	200	3.5	
	Clear to Output				200▲	-	-	
CD40175B	Clock to Q Output				400	200	2.0	
	Clear to Q Output				500▲	-	-	

* t_{TLH} or t_{PLH}

▲ t_{THL} or t_{PHL}

TYPE	CONDITIONS* V _{DD} = 5V, C _L = 50pF	PROP. DELAY (ns)	TRANS. TIME (ns)	MAX. CLOCK INPUT FREQ. (MHz)
CD40181B	A or B to F (Logic Mode) A or B to G or P	800	200	-
	A or B to F, C _n + 4, or A = B	1000	-	-
	C _n to F	640	-	-
	C _n to C _n + 4	400	-	-
CD40182B	P, G _{IN} to P, G _{OUT} and Carry Outs	400	200	-
	C _n to Carry Outs	480	-	-
CD40192B, 193B	Clock Up or Clock Down to Q, Reset Q	500	200	2
	PE to Q	400	-	-
	Clock Up to Carry, Clock Down to Borrow	320	-	-
	Reset or PE to Borrow or Carry	600	-	-
CD40194B	Clock to Q	440	200	3
	Reset to Q	460▲	-	-
CD40208B	Clock or Write Enable to Q	720	200	1.5
	Read or Write Address to Q	600	-	-
	3-State Disable Delay Time	200	-	-
CD40257B	t _{PZH} , t _{PHZ}	260	-	-
	t _{PZL} , t _{PLZ}	260	-	-
	Data Input to Output	300	200	-
	Select to Output	380	-	-
	Output Disable to Output	-	-	-
t _{PZH} , t _{PHZ}	190	-	-	
t _{PZL} , t _{PLZ}	190	-	-	

Functional Diagrams

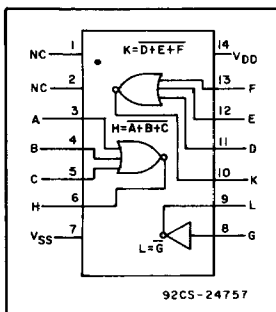

Dual 3-Input NOR Gate Plus Inverter

CD4000B (File No. 985)

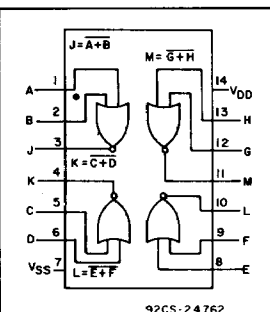

Quad 2-Input NOR Gate

CD4001B (File No. 985)
CD4001 (File No. 945)

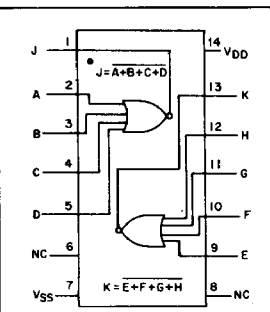

Dual 4-Input NOR Gate

CD4002B (File No. 985)

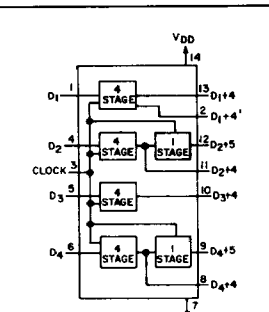

18-Stage Static Shift Register

CD4006B (File No. 1033)

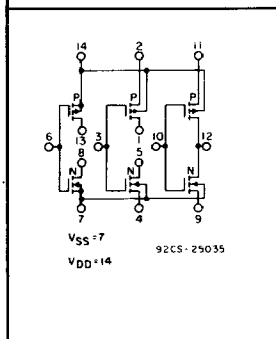

Dual Complementary Pair Plus Inverter

CD4007UB (File No. 977)

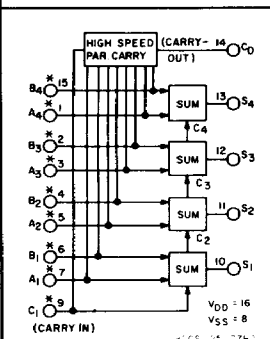

4-Bit Full Adder with Parallel Carry Out

CD4008B (File No. 951)

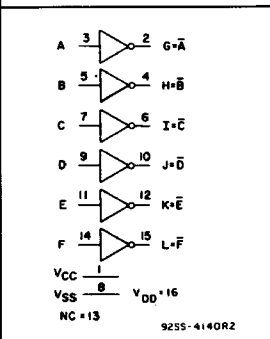

Hex Buffer/Converter Inverting Type

CD4009UB (File No. 940)

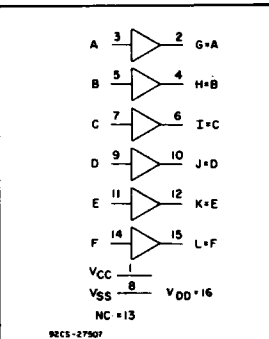

Hex Buffer/Converter Non-Inverting Type

CD4010B (File No. 940)

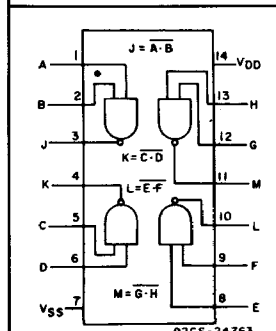

Quad 2-Input NAND Gate

CD4011B (File No. 986)

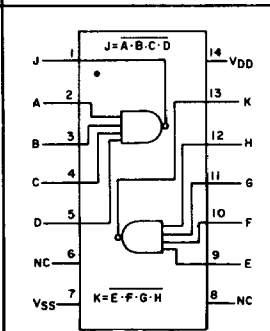

Dual 4-Input NAND Gate

CD4012B (File No. 986)

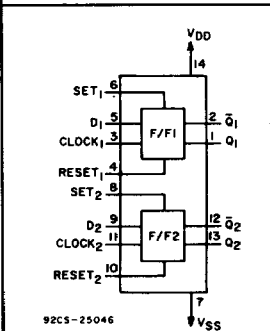

Dual "D" Flip-Flop with Set/Reset Capability

CD4013B (File No. 936)

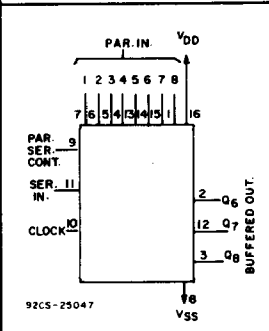

8-State Synchronous Shift Register with Parallel or Serial Input/Serial Output

CD4014B (File No. 1043)

Functional Diagrams

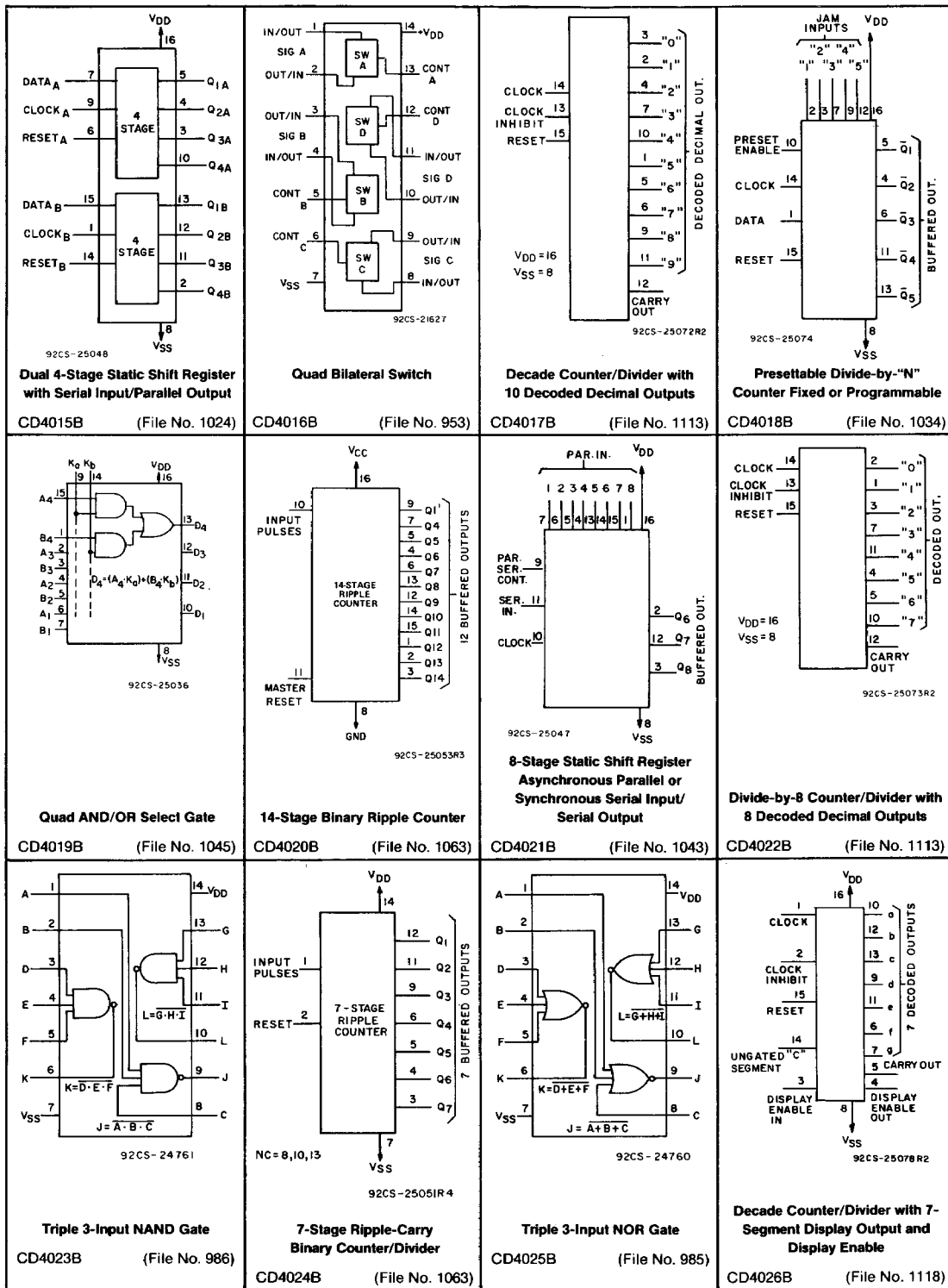

Functional Diagrams

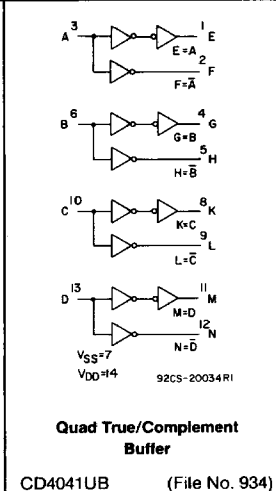
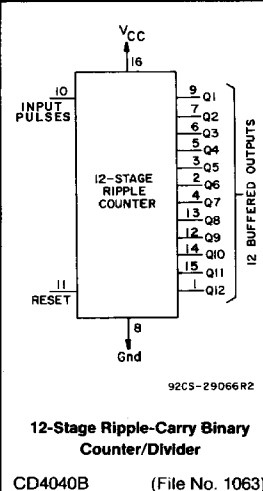
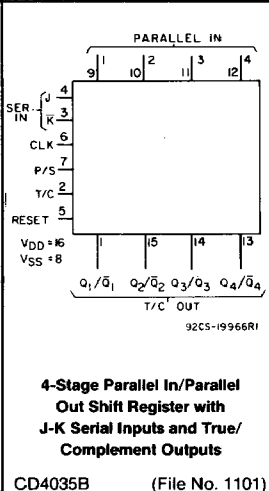
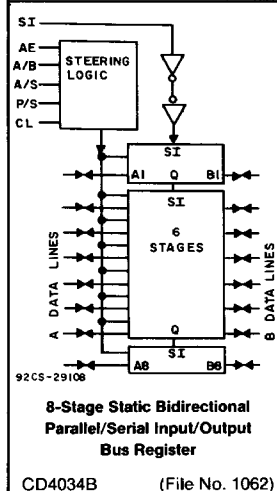
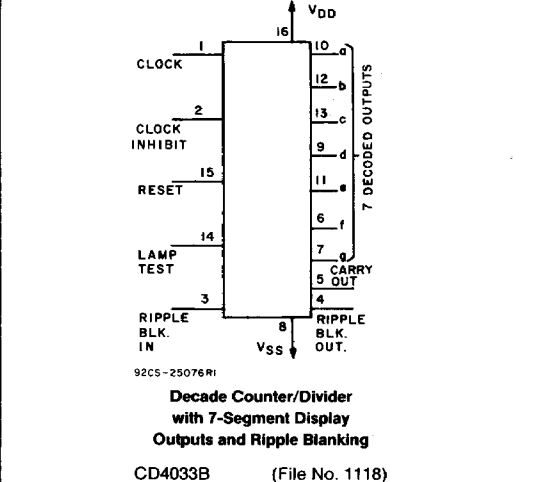
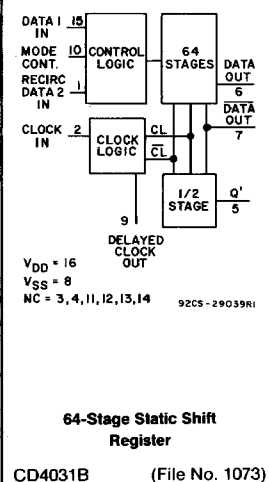
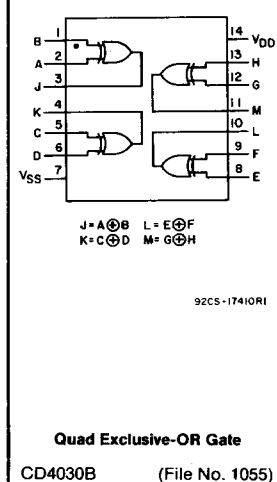
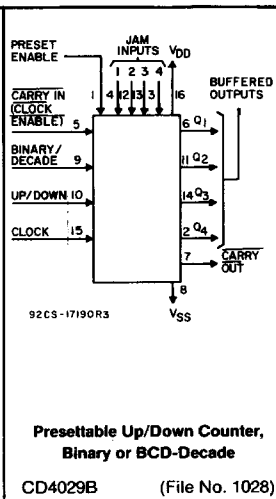
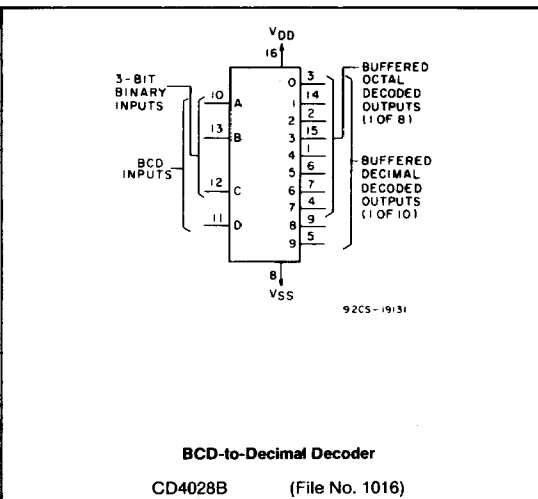
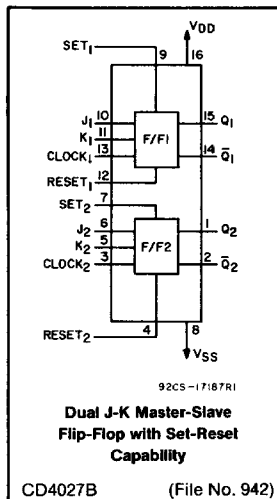

Functional Diagrams

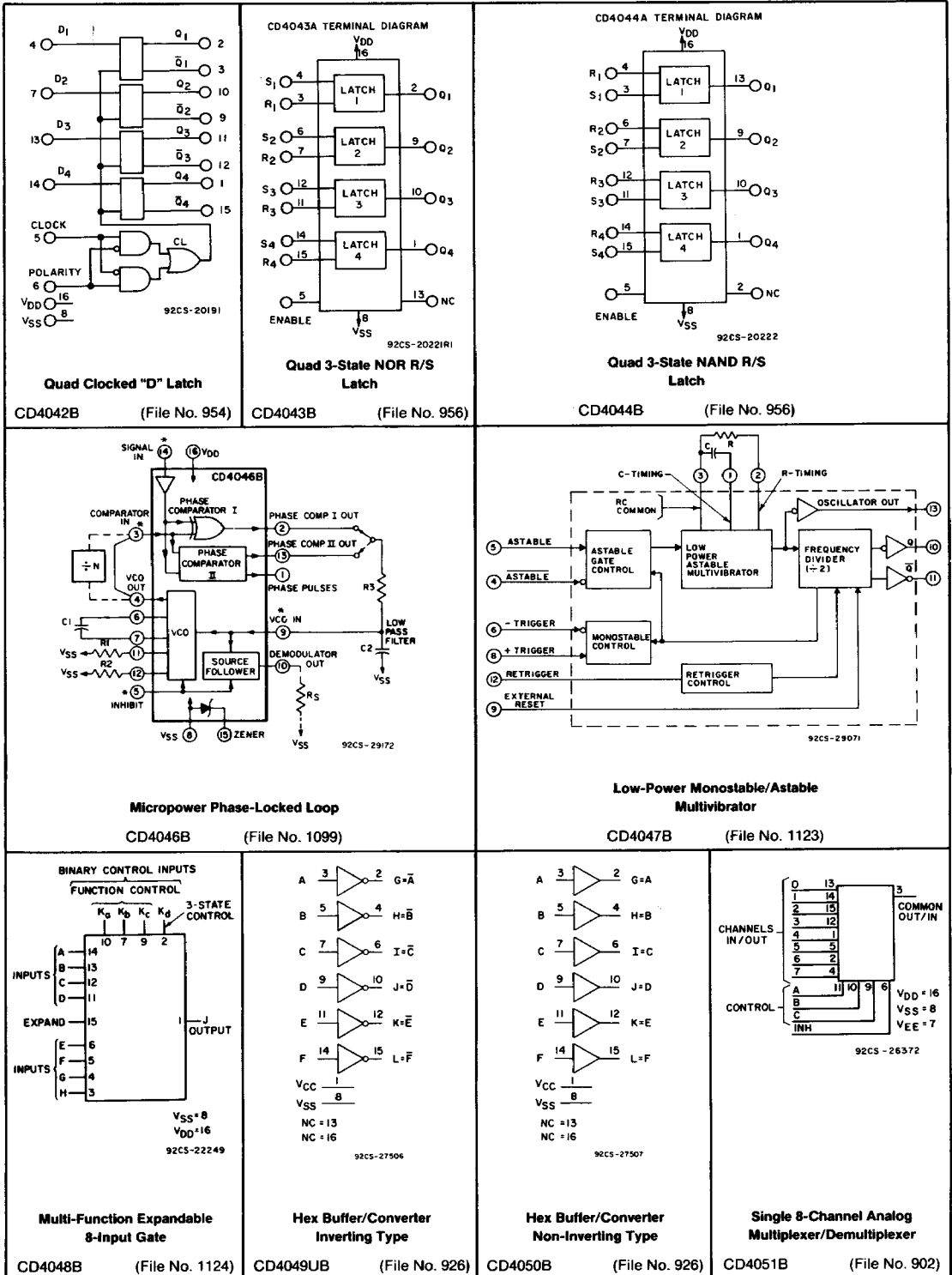

Functional Diagrams

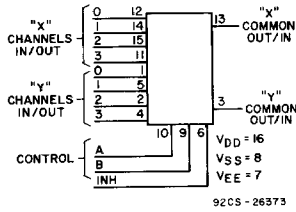

Differential 4-Channel Analog Multiplexer/Demultiplexer
 CD4052B (File No. 902)

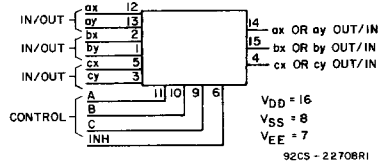

Triple 2-Channel Multiplexer/Demultiplexer
 CD4053B (File No. 902)

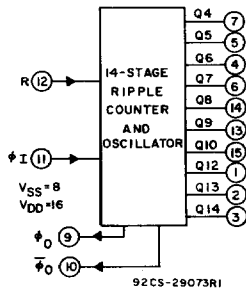

14-Stage Ripple-Carry Binary Counter/Divider and Oscillator
 CD4060B (File No. 1120)

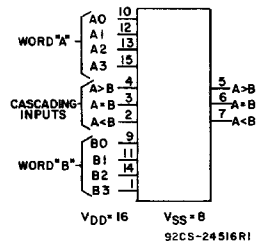

4-Bit Magnitude Comparator
 CD4063B (File No. 805)

Functional Diagrams

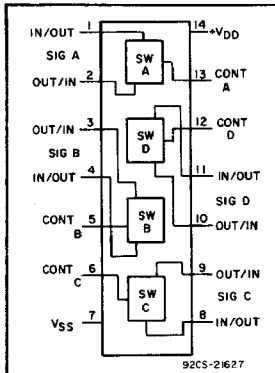

Quad Bilateral Switch

CD4066B (File No. 1114)

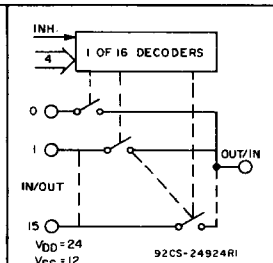

16-Channel Multiplexer/Demultiplexer

CD4067B (File No. 909)

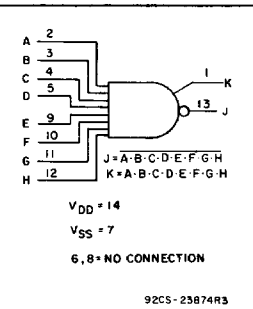

8-Input NAND/AND Gate

CD4068B (File No. 809)

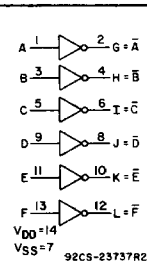

Hex Inverter

CD4069UB (File No. 804)

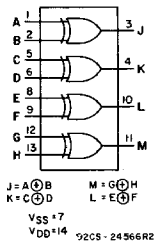

Quad Exclusive-OR Gate

CD4070B (File No. 910)

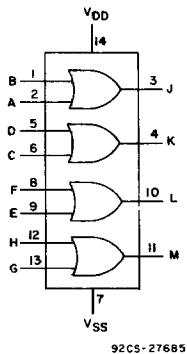

Quad 2-Input OR Gate

CD4071B (File No. 807)

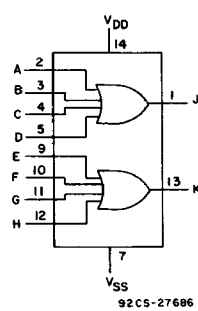

Dual 4-Input OR Gate

CD4072B (File No. 807)

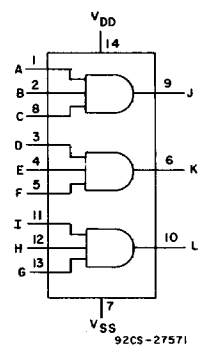

Triple 3-Input AND Gate

CD4073B (File No. 806)

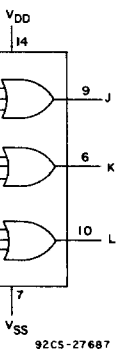

Triple 3-Input OR Gate

CD4075B (File No. 807)

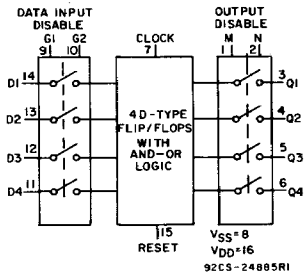

4-Bit D-Type Register

CD4076B (File No. 903)

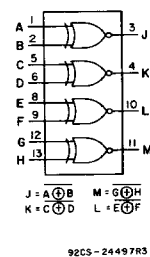

Quad Exclusive-NOR Gate

CD4077B (File No. 910)

Functional Diagrams

<p>8-Input NOR/OR Gate</p> <p>CD4078B (File No. 810)</p>	<p>Quad 2-Input AND Gate</p> <p>CD4081B (File No. 806)</p>	<p>Dual 4-Input AND Gate</p> <p>CD4082B (File No. 806)</p>	<p>Dual 2-Wide, 2-Input AND-OR-INVERT (AOI) Gate</p> <p>CD4085B (File No. 811)</p>
<p>Expandable 4-Wide, 2-Input AND-OR-INVERT (AOI) Gate</p> <p>CD4086B (File No. 812)</p>		<p>Binary Rate Multiplier</p> <p>CD4089B (File No. 1003)</p>	
<p>Quad 2-Input NAND Schmitt Trigger</p> <p>CD4093B (File No. 836)</p>	<p>8-Stage Shift-and-Store Bus Register</p> <p>CD4094B (File No. 869)</p>	<p>Gated J-K Master-Slave Flip-Flop, Non-Inverting Inputs</p> <p>CD4095B (File No. 879)</p>	<p>Gated J-K Master-Slave Flip-Flop, Inverting and Non-Inverting Inputs</p> <p>CD4096B (File No. 879)</p>

Functional Diagrams

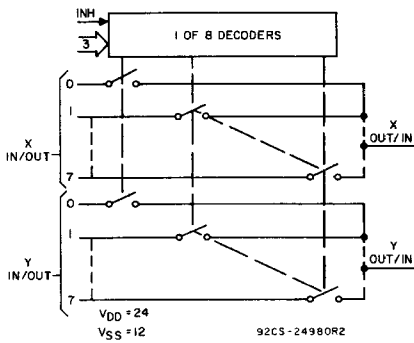

Differential 8-Channel Multiplexer/Demultiplexer

CD4097B (File No. 909)

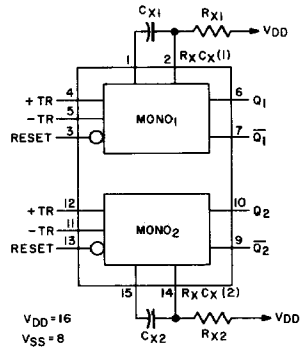

Dual Monostable Multivibrator

CD4098B (File No. 979)

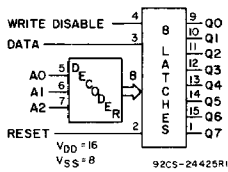

8-Bit Addressable Latch

CD4099B (File No. 948)

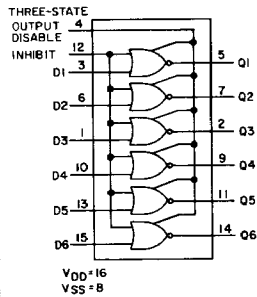

Strobed Hex Inverter/Buffer

CD4502B (File No. 1002)

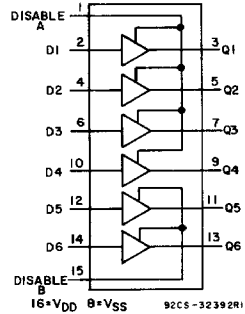

Hex Buffer Non-Inverting Type

CD4503B (File No. 1224)

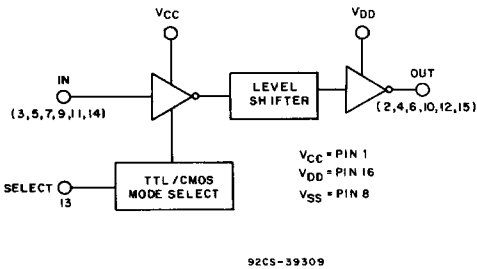

Hex Voltage-Level Shifter for TTL-to-CMOS or CMOS-to-CMOS Operation

CD4504B (File No. 1846)

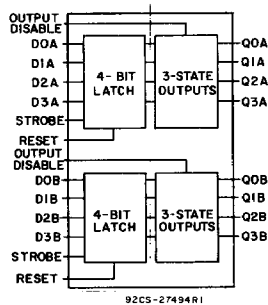

Dual 4-Bit Latch

CD4508B (File No. 1009)

Functional Diagrams

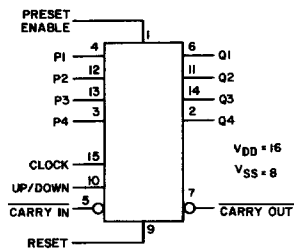

92CS-24824

BCD Presettable Up/Down Counter

CD4510B (File No. 899)

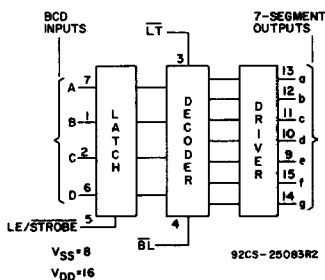

92CS-25083R2

BCD-to-7-Segment Latch Decoder Driver

CD4511B (File No. 901)

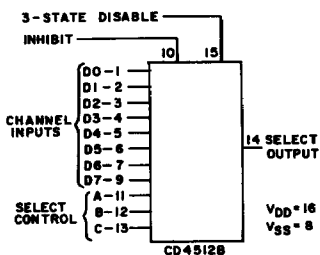

92CS-28929

8-Channel Data Selector

CD4512B (File No. 1032)

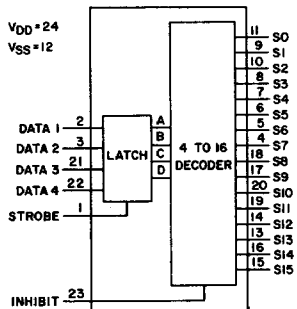

92CS-24597

4-Bit Latch/4-to-16 Line Decoder

CD4514B (File No. 814) CD4515B (File No. 814)
Output "High" on Select Output "Low" on Select

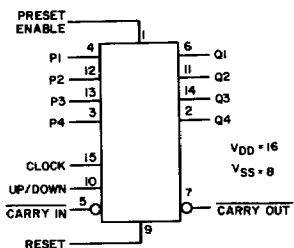

92CS-24824

Binary Presettable Up/Down Counter

CD4516B (File No. 899)

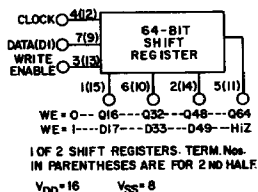

92CS-30371

Dual 64-Bit Shift Register

CD4517B (File No. 1148)

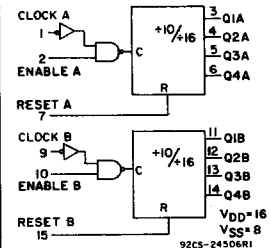

92CS-24506R1

Dual Up Counter

CD4518B (File No. 808) BCD
CD4520B (File No. 808) Binary

Functional Diagrams

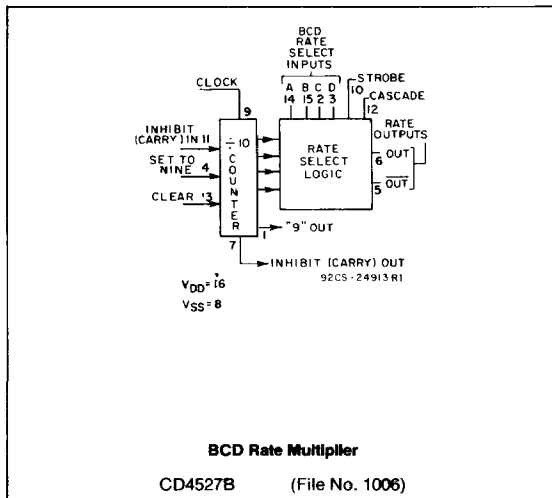

BCD Rate Multiplier

CD4527B (File No. 1006)

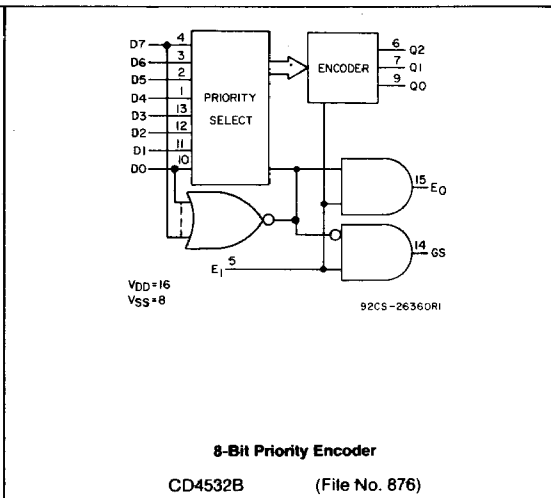

8-Bit Priority Encoder

CD4532B (File No. 876)

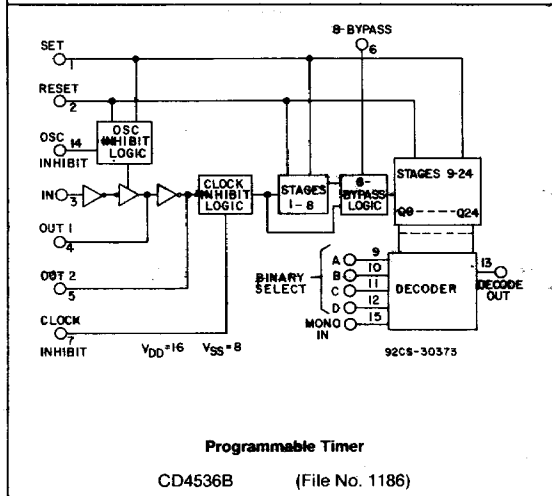

Programmable Timer

CD4536B (File No. 1186)

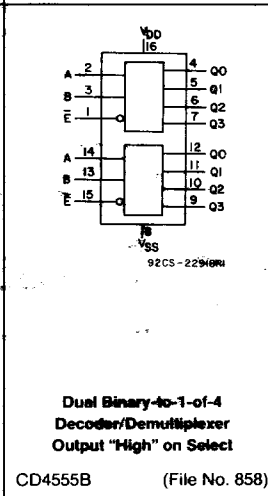

Dual Binary-to-1-of-4 Decoder/Demultiplexer Output "High" on Select

CD4555B (File No. 858)

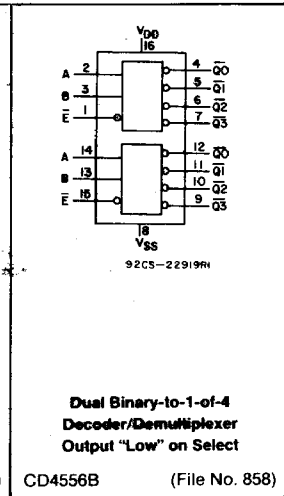

Dual Binary-to-1-of-4 Decoder/Demultiplexer Output "Low" on Select

CD4556B (File No. 858)

Functional Diagrams

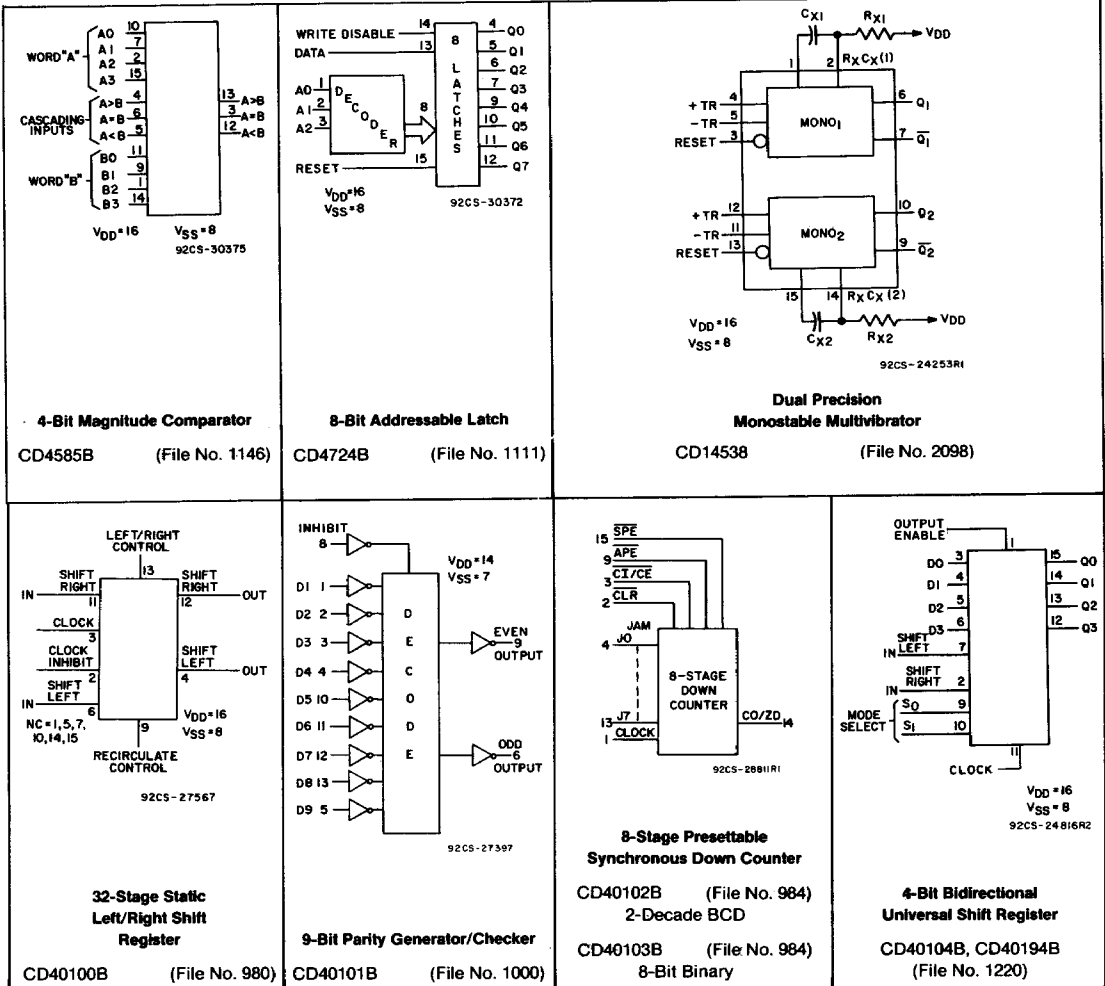

File No. = commercial data sheet

Functional Diagrams

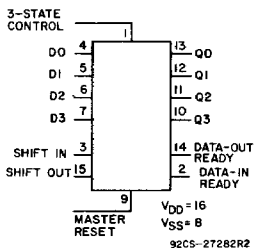

FIFO Register
4-Bits Wide by 16-Bits Long
CD40105B (File No. 1044)

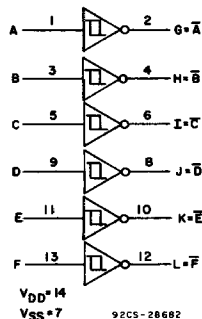

Hex Schmitt Trigger
CD40106B (File No. 1017)

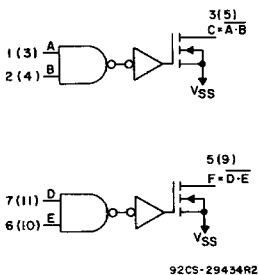

Dual 2-Input NAND Buffer/Driver
CD40107B (File No. 1015)

NOTE:
NUMBERS IN PARENTHESES
FOR CD40107BF, OTHERS
FOR CD40107BE.

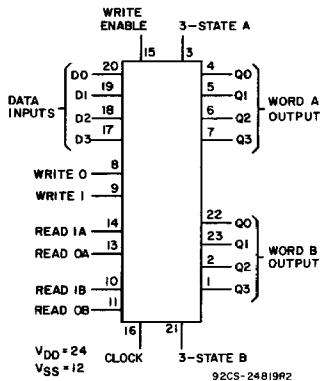

4-by-4 Multiport Register
CD40108B (File No. 1011)

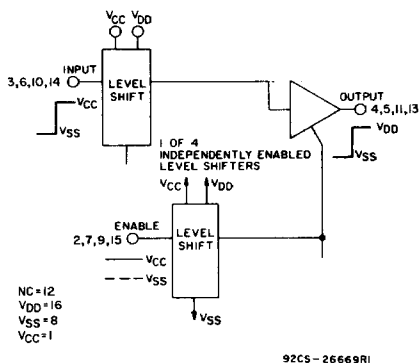

Quad Low-to-High Voltage Level Shifter
CD40109B (File No. 1018)

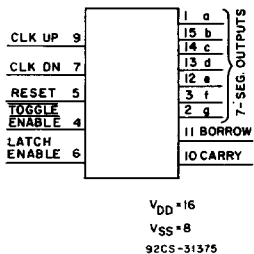

**Decade Up-Down Counter/
Decoder/Latch/Driver**
CD40110B (File No. 1125)

Functional Diagrams

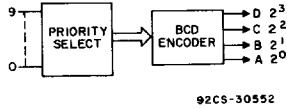

**10-Line-to-4-Line
BCD Priority Encoder**

CD40147B (File No. 1117)

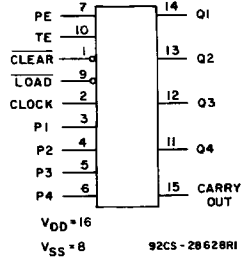

Synchronous 4-Bit Counter

CD40160B (File No. 1047)
Decade with Asynchronous Clear
CD40161B (File No. 1047)
Binary with Asynchronous Clear
CD40162B (File No. 1047)
Decade with Synchronous Clear
CD40163B (File No. 1047)
Binary with Synchronous Clear

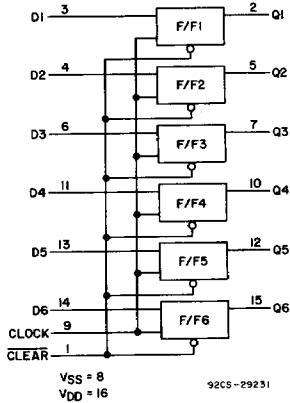

Hex "D" Type Flip-Flop

CD40174B (File No. 1031)

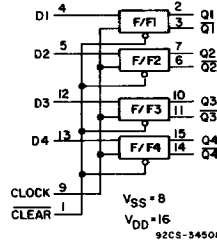

Quad 'D' Type Flip-Flop

CD40175B (File No. 1326)

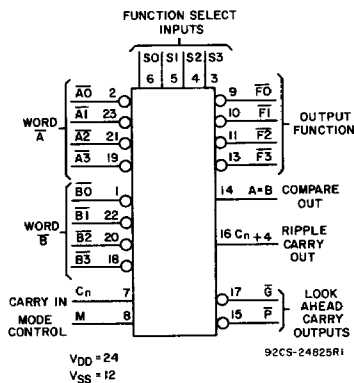

Active-Low Data

CD40181B

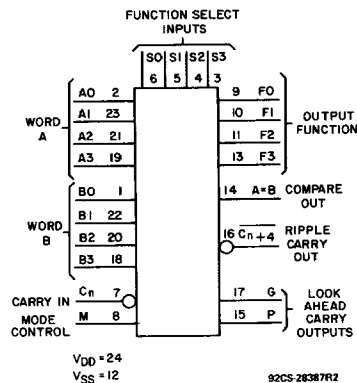

Active-High Data

(File No. 989)

High Reliability CD4000B-Series CMOS ICs

Functional Diagrams

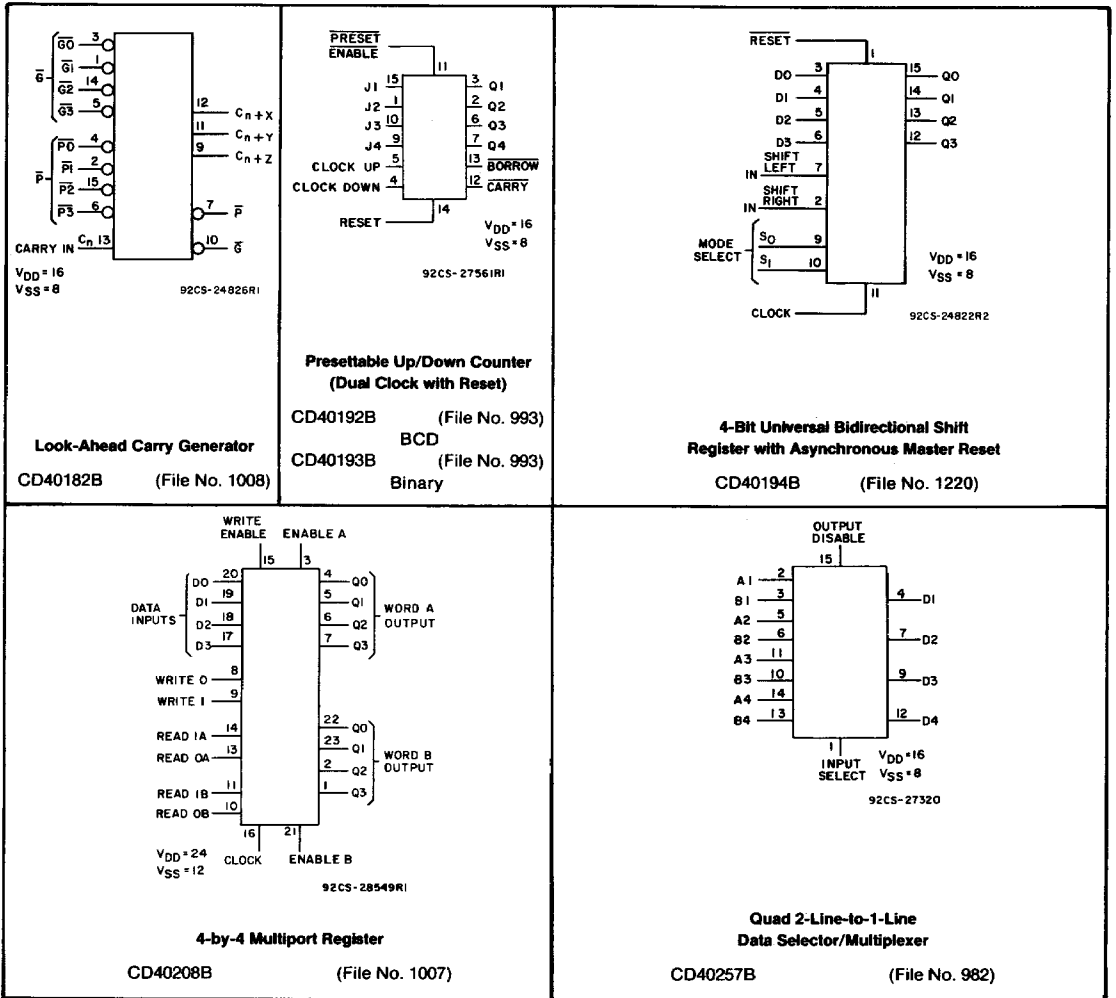

File No. = commercial data sheet

High Reliability CD4000B-Series CMOS ICs

Static Burn-In Test Circuit Connections

For Type A devices, use $V_{DD} = 12.5V$. For Type B and UB devices, use $V_{DD} = 18V$.

NOTE: Each pin except V_{DD} and V_{SS} must have resistors of 2-47 kilohms. In most cases, V_{SS} is at pin 7 (of 14-pin IC), pin 8 (of 16-pin) or pin 12 (of 24-pin), while V_{DD} is at the highest-numbered pin; exceptions are noted by an asterisk (*).

TYPE	STATIC BURN-IN I			STATIC BURN-IN II		
	OPEN	GROUND	V_{DD}	OPEN	GROUND	V_{DD}
CD4000	1,2,6,9,10	3-5,7,8,11-13	14	1,2,6,9,10	7	3-5,8,11-14
CD4001	3,4,10,11	1,2,5-9,12,13	14	3,4,10,11	7	1,2,5,6,8,9,12-14
CD4002	1,6,8,13	2-5,7,9-12	14	1,6,8,13	7	2-5,9-12,14
CD4006	2,8-13	1,3-7	14	2,8-13	7	1,3-6,14
CD4007	1,5,8,12,13	3,4,6,7,9,10	2,11,14	1,5,8,12,13	4,7,9	2,3,6,10,11,14
CD4008	10-14	1-9,15	16	10-14	8	1-7,9,15,16
CD4009*	2,4,6,10,12,13,15	3,5,7-9,11,14	1*,16*	2,4,6,10,12,13,15	8	1*,3,5,7,9,11,14,16*
CD4010*	2,4,6,10,12,13,15	3,5,7-9,11,14	1*,16*	2,4,6,10,12,13,15	8	1*,3,5,7,9,11,14,16*
CD4011	3,4,10,11	1,2,5-9,12,13	14	3,4,10,11	7	1,2,5,6,8,9,12-14
CD4012	1,6,8,13	2-5,7,9-12	14	1,6,8,13	7	2-5,9-12,14
CD4013	1,2,12,13	3-11	14	1,2,12,13	7	3-6,8-11,14
CD4014	2,3,12	1,4-11,13-15	16	2,3,12	8	1,4-7,9-11,13-16
CD4015	2-5,10-13	1,6-9,14,15	16	2-5,10-13	8	1,6,7,9,14-16
CD4016	2,3,9,10	1,4-8,11-13	14	2,3,9,10	7	1,4-6,8,11-14
CD4017	1-7,9-12	8,13,15	14,16	1-7,9-12	8,14	13,15,16
CD4018	4-6,11,13	1-3,7-9,12,14,15	16	4-6,11,13	8	1-3,7,9,10,12,14-16
CD4019	10-13	1-9,14,15	16	10-13	8	1-7,9,14-16
CD4020	1-7,9,12-15	8,10,11	16	1-7,9,12-15	8	10,11,16
CD4021	2,3,12	1,4-11,13-15	16	2,3,12	8	1,4-7,9-11,13-16
CD4022	1-7,9-12	8,13,15	14,16	1-7,9-12	8,14	13,15,16
CD4023	6,9,10	1-5,7,8,11-13	14	6,9,10	7	1-5,8,11-14
CD4024	3-6,8-13	1,2,7	14	3-6,8-13	7	1,2,14
CD4025	6,9,10	1-5,7,8,11-13	14	6,9,10	7	1-5,8,11-14
CD4026	4-7,9-14	1-3,8,15	16	4-7,9-14	8	1-3,15,16
CD4027	1,2,14,15	3-13	16	1,2,14,15	8	3-7,9-13,16
CD4028	1-7,9,14,15	8,10-13	16	1-7,9,14,15	8	10-13,16
CD4029	2,6,7,11,14	1,3-5,8-10,12,13,15	16	2,6,7,11,14	8	1,3-5,9,10,12,13,15,16
CD4030	3,4,10,11	1,2,5-9,12,13	14	3,4,10,11	7	1,2,5,6,8,9,12-14
CD4031	3-7,9,11-14	1,2,8,10,15	16	3-7,9,11-14	8	1,2,10,15,16
CD4033	4-7,9-13	1-3,8,14,15	16	4-7,9-13	8	1-3,14-16
CD4034	1-8	12,15-23	9-11,13,14,24	1-8	12	9-11,13-24
CD4035	1,13-15	2-12	16	1,13-15	8	2-7,9-12,16
CD4040	1-7,9,12-15	8,10,11	16	1-7,9,12-15	8	10,11,16
CD4041	1,2,4,5,8,9,11,12	3,6,7,10,13	14	1,2,4,5,8,9,11,12	7	3,6,10,13,14
CD4042	1-3,9-12,15	4-8,13,14	16	1-3,9-12,15	8	4-7,13,14,16
CD4043	1,2,9,10,13	3-8,11,12,14,15	16	1,2,9,10,13	8	3-7,11,12,14-16
CD4044	1,2,9,10,13	3-8,11,12,14,15	16	1,2,9,10,13	8	3-7,11,12,14-16
CD4046	1,2,4,6,7,10,11,13,15	3,5,8,9,14	12,16	1,2,4,6,7,10,11,13,15	8	3,5,9,12,14,16
CD4047	1,2,10,11,13	3-9,12	14	1,2,10,11,13	7	3-6,8,9,12,14

Non-standard pin arrangement, or multiple supply pins; connect pins marked () without using resistor.

High Reliability CD400B-Series CMOS ICs

Static Burn-In Test Circuit Connections

TYPE	STATIC BURN-IN I			STATIC BURN-IN II		
	OPEN	GROUND	V _{DD}	OPEN	GROUND	V _{DD}
CD4048	1	2-15	16	1	8	2-7,9-16
CD4049*	2,4,6,10,12,13,15	3,5,7-9,11,14	1*,16*	2,4,6,10,12,13,15	8	1*,3,5,7,9,11,14,16*
CD4050*	2,4,6,10,12,13,15	3,5,7-9,11,14	1*,16*	2,4,6,10,12,13,15	8	1*,3,5,7,9,11,14,16*
CD4051*	3	1,2,4-6,7*,8*,9-15	16	3	7*,8*	1,2,4-6,9-16
CD4052*	3,13	1,2,4-6,7*,8*,9-12,14,15	16	3,13	7*,8*	1,2,4-6,9-12,14-16
CD4053*	4,14,15	1-3,5,6,7*,8*,9-13	16	4,14,15	7*,8*	1-3,5,6,9-13,16
CD4060	1-7,9,10,13-15	8,11,12	16	1-7,9,10,13-15	8	11,12,16
CD4063	5-7	1,2,4,8-15	3,16	5-7	3,8	1,2,4,9-16
CD4066	2,3,9,10	1,4-8,11-13	14	2,3,9,10	7	1,4-6,8,11-14
CD4067	1	2-23	24	1	12	2-11,13-23
CD4068	1,6,8,13	2-5,7,9-12	14	1,6,8,13	7	2-5,9-12,14
CD4069	2,4,6,8,10,12	1,3,5,7,9,11,13	14	2,4,6,8,10,12	7	1,3,5,9,11,13,14
CD4070	3,4,10,11	1,2,5-9,12,13	14	3,4,10,11	7	1,2,5,6,8,9,12-14
CD4071	3,4,10,11	1,2,5-9,12,13	14	3,4,10,11	7	1,2,5,6,8,9,12-14
CD4072	1,6,8,13	2-5,7,9-12	14	1,6,8,13	7	2-5,9-12,14
CD4073	6,9,10	1-5,7,8,11-13	14	6,9,10	7	1-5,8,11-14
CD4075	6,9,10	1-5,7,8,11-13	14	6,9,10	7	1-5,8,11-14
CD4076	3-6	1,2,7-15	16	3-6	8	1,2,7,9-16
CD4077	3,4,10,11	1,2,5-9,12,13	14	3,4,10,11	7	1,2,5,6,8,9,12-14
CD4078	1,6,8,13	2-5,7,9-12	14	1,6,8,13	7	2-5,9-12,14
CD4081	3,4,10,11	1,2,5-9,12,13	14	3,4,10,11	7	1,2,5,6,8,9,12-14
CD4082	1,6,8,13	2-5,7,9-12	14	1,6,8,13	7	2-5,9-12,14
CD4085	3,4	1,2,5-13	14	3,4	7	1,2,5,6,8-14
CD4086	3,4	1,2,5-13	14	3,4	7	1,2,5,6,8-14
CD4089	1,5-7	2-4,8-15	16	1,5-7	8	2-4,9-16
CD4093	3,4,10,11	1,2,5-9,12,13	14	3,4,10,11	7	1,2,5,6,8,9,12-14
CD4094	4-7,9-14	1-3,8,15	16	4-7,9-14	8	1-3,15,16
CD4095	1,6,8	2-5,7,9-13	14	1,6,8	7	2-5,9-14
CD4096	1,6,8	2-5,7,9-13	14	1,6,8	7	2-5,9-14
CD4097	1,17	2-16,18-23	24	1,17	12	2-11,13-24
CD4098	2,6,7,9,10,14	1,3-5,8,11-13,15	16	2,6,7,9,10,14	1,8,15	3-5,11-13,16
CD4099	1,9-15	2-8	16	1,9-15	8	2-7,16
CD4502	2,5,7,9,11,14	1,3,4,6,8,10,12,13,15	16	2,5,7,9,11,14	8	1,3,4,6,10,12,13,15,16
CD4503	3,5,7,9,11,13	1,2,4,6,8,10,12,14,15	16	3,5,7,9,11,13	8	1,2,4,6,10,12,14-16
CD4504	2,4,6,10,12,15	3,5,7-9,11,14	16 (1*,13) ¹	2,4,6,10,12,15	8	16 (1*,3,5,7,9,11,13,14) ¹
CD4508	5,7,9,11,17,19,21,23	1-4,6,8,10,12-16,18,20,22	24	5,7,9,11,17,19,21,23	12	1-4,6,8,10,13-16,18,20,22,24
CD4510	2,6,7,11,14	1,3-5,8-10,12,13,15	16	2,6,7,11,14	8	1,3-5,9,10,12,13,15,16
CD4511	9-15	1-8	16	9-15	8	1-7,16
CD4512	14	1-13,15	16	14	8	1-7,9-13,15,16

Non-standard pin arrangement, or multiple supply pins; connect pins marked () without using resistor.

¹Pin voltage is V_{DD}/2 for pins inside parentheses.

High Reliability CD400B-Series CMOS ICs

Static Burn-In Test Circuit Connections

TYPE	STATIC BURN-IN I			STATIC BURN-IN II		
	OPEN	GROUND	V _{DD}	OPEN	GROUND	V _{DD}
CD4514	4-11,13-20	1-3,12,21-23	24	4-11,13-20	12	1-3,21-24
CD4515	4-11,13-20	1-3,12,21-23	24	4-11,13-20	12	1-3,21-24
CD4516	2,6,7,11,14	1,3-5,8-10,12,13,15	16	2,6,7,11,14	8	1,3-5,9,10,12,13,15,16
CD4517	1,2,5,6,10,11,14,15	3,4,7-9,12,13	16	1,2,5,6,10,11,14,15	8	3,4,7,9,12,13,16
CD4518	3-6,11-14	1,2,7-10,15	16	3-6,11-14	8	1,2,7,9,10,15,16
CD4520	3-6,11-14	1,2,7-10,15	16	3-6,11-14	8	1,2,7,9,10,15,16
CD4527	1,5-7	2-4,8-15	16	1,5-7	8	2-4,9-16
CD4532	6,7,9,14,15	1-5,8,10-13	16	6,7,9,14,15	8	1-5,10-13,16
CD4536	4,5,13	1-3,6-12,14,15	16	4,5,13	8	1-3,6,7,9-12,14-16
CD4555	4-7,9-12	1-3,8,13-15	16	4-7,9-12	8	1-3,13-16
CD4556	4-7,9-12	1-3,8,13-15	16	4-7,9-12	8	1-3,13-16
CD4585	3,12,13	1,2,4-11,14,15	16	3,12,13	8	1,2,4-7,9-11,14-16
CD4724	4-7,9-12	1-3,8,13-15	16	4-7,9-12	8	1,3,13-16
CD14538	2,6,7,9,10,14	1,3-5,8,11-13,15	16	2,6,7,9,10,14	1,8,15	3-5,11-13,16
CD40100	1,4,5,7,10,12,14,15	2,3,6,8,9,11,13	16	1,4,5,7,10,12,14,15	8	2,3,6,9,11,13,16
CD40101	6,9	1-5,7,8,10-13	14	6,9	7	1-5,8,10-14
CD40102	14	1-13,15	16	14	8	1-7,9-13,15,16
CD40103	14	1-13,15	16	14	8	1-7,9-13,15,16
CD40104	12-15	1-11	16	12-15	8	1-7,9-11,16
CD40105	2,10-14	1,3-9,15	16	2,10-14	8	1,3-7,9,15,16
CD40106	2,4,6,8,10,12	1,3,5,7,9,11,13	14	2,4,6,8,10,12	7	1,3,5,9,11,13,14
CD40107	1,2,5,6,8,9,12,13	3,4,7,10,11	14	1,2,5,6,8,9,12,13	7	3,4,10,11,14
CD40108	1,2,4-7,22,23	3,8-21	24	1,2,4-7,22,23	12	3,8-11,13-21,24
CD40109*	4,5,11-13	2,3,6-10,14,15	1*,16	4,5,11-13	8	(1*,2,3,6,7,9,10,14,15) ¹ 16
CD40110	1-3,10-15	4-9	16	1-3,10-15	8	4-7,9,16
CD40147	6,7,9,14	1-5,8,10-13,15	16	6,7,9,14	8	1-5,10-13,15,16
CD40160	11-15	1-10	16	11-15	8	1-7,9,10,16
CD40161	11-15	1-10	16	11-15	8	1-7,9,10,16
CD40162	11-15	1-10	16	11-15	8	1-7,9,10,16
CD40163	11-15	1-10	16	11-15	8	1-7,9,10,16
CD40174	2,5,7,10,12,15	1,3,4,6,8,9,11,13,14	16	2,5,7,10,12,15	8	1,3,4,6,9,11,13,14,16

*Non-standard pin arrangement, or multiple supply pins; connect pins marked (•) without using resistor.

¹Pin voltage is V_{DD}/2 for pins inside parentheses.

²V_{DD} = 11.5 volts; V_{CC} = 6.5 volts; use 300 Ω resistors at pins 10,13-21.

High Reliability CD4000B-Series CMOS ICs

Static Burn-In Test Circuit Connections

TYPE	STATIC BURN-IN I			STATIC BURN-IN II		
	OPEN	GROUND	V _{DD}	OPEN	GROUND	V _{DD}
CD40175	2,3,6,7,10,11,14,15	1,4,5,8,9,12,13	16	2,3,6,7,10,11,14,15	8	1,4,5,9,12,13,16
CD40181	9-11,13-17	1-8,12,18-23	24	9-11,13-17	12	1-8,18-24
CD40182	7,9-12	1-6,8,13-15	16	7,9-12	8	1-6,13-16
CD40192	2,3,6,7,12,13	1,4,5,8-11,14,15	16	2,3,6,7,12,13	8	1,4,5,9-11,14-16
CD40193	2,3,6,7,12,13	1,4,5,8-11,14,15	16	2,3,6,7,12,13	8	1,4,5,9-11,14-16
CD40194	12-15	1-11	16	12-15	8	1-7,9-11,16
CD40208	1,2,4-7,22,23	3,8-21	24	1,2,4-7,22,23	12	3,8-11,13-21,24
CD40257	4,7,9,12	1-3,5,6,8,10,11,13-15	16	4,7,9,12	8,15	1-3,5,6,10,11,13,14,16

Dynamic Burn-In Test Circuit Connections

TYPE	OPEN	GROUND	1/2 V _{DD}	V _{DD}	OSCILLATOR	
					50 kHz	25 kHz
CD4000	1,2	7	6,9,10	14	3-5,8,11-13	—
CD4001	—	7	3,4,10,11	14	1,2,5,6,8,9,12,13	—
CD4002	6,8	7	1,13	14	2-5,9-12	—
CD4006	2	7	8-13	14	3	1,4-6
CD4007	—	4,7,9	1,5,8,12,13	2,11,14	3,6,10	—
CD4008	—	8	10-14	16	2,4,6,15	1,3,5,7,9
CD4009*	13	8	2,4,6,10,12,15	1*,16*	3,5,7,9,11,14	—
CD4010*	13	8	2,4,6,10,12,15	1*,16*	3,5,7,9,11,14	—
CD4011	—	7	3,4,10,11	14	1,2,5,6,8,9,12,13	—
CD4012	6,8	7	1,13	14	2-5,9-12	—
CD4013	—	4,6-8,10	1,2,12,13	14	3,11	5,9
CD4014	—	1,4-9,13-15	2,3,12	16	10	11
CD4015	—	6,8,14	2-5,10-13	16	1,9	7,15
CD4016	—	7	2,3,9,10	14	5,6,12,13	1,4,8,11
CD4017	—	8,13,15	1-7,9-12	16	14	—
CD4018	—	2,8,9,15	4-6,11,13	1,3,12,16	7,14	10
CD4019	—	8	10-13	16	—	1-7,9,14,15
CD4020	—	8,11	1-7,9,12-15	16	10	—
CD4021	—	1,4-9,13-15	2,3,12	16	10	11
CD4022	—	8,13,15	1-7,9-12	16	14	—
CD4023	—	7	6,9,10	14	1-5,8,11-13	—
CD4024	8,10,13	2,7	3-6,9,11,12	14	1	—
CD4025	—	7	6,9,10	14	1-5,8,11-13	—
CD4026	—	2,8,15	4-7,9-14	3,16	1	—
CD4027	—	4,7-9,12	1,2,14,15	5,6,10,11,16	3,13	—
CD4028	—	8	1-7,9,14,15	16	10,12,13	11
CD4029	—	1,3-5,8,12,13	2,6,7,11,14	9,10,16	15	—
CD4030	—	7	3,4,10,11	14	2,6,9,13	1,5,8,12
CD4031	3-5,11-14	8,15	6,7,9	1,16	2	10

Non-standard pin arrangement, or multiple supply pins; connect pins marked () without using a resistor.

High Reliability CD400B-Series CMOS ICs

Dynamic Burn-In Test Circuit Connections

TYPE	OPEN	GROUND	1/2 V _{DD}	V _{DD}	OSCILLATOR	
					50 kHz	25 kHz
CD4033	—	2,3,8,14,15	4-7,9-13	16	1	—
CD4034	—	1-8,11-14	16-23	9,24	15	10
CD4035	1,3,4	2,5,7-12	13-15	16	6	—
CD4040	—	8,11	1-7,9,12-15	16	10	—
CD4041	—	7	1,2,4,5,8,9,11,12	14	3,6,10,13	—
CD4042	—	8	1-3,9-12,15	6,16	5	4,7,13,14
CD4043	13	8	1,2,9,12	5,16	4,6,12,14	3,7,11,15
CD4044	2	8	1,9,10,13	5,16	4,6,12,14	3,7,11,15
CD4046	1,4,6,7,10,11,13,15	8,9	2	3,5,12,16	14	—
CD4047	—	7,9,12	1,2,10,11,13	4,5,14	6,8	3
CD4048	—	8,15	1	2,16	9-14	3-7
CD4049*	13	8	2,4,6,10,12,15	1*,16	3,5,7,9,11,14	—
CD4050*	13	8	2,4,6,10,12,15	1*,16	3,5,7,9,11,14	—
CD4051*	—	4-6,7*,8*,9,12,14	3	1,2,13,15,16	11	10
CD4052*	—	4-6,7*,8*,12,15	3,13	1,2,11,14,16	10	9
CD4053*	—	1,5,6,7*,8*,12	4,14,15	2,3,13,16	9-11	—
CD4054	—	7*,8	3-6	1,10,12,14	2	9,11,13,15
CD4055	—	7*,8	1,9-15	16	6	2-5
CD4056	—	7*,8	9-15	1,16	6	2-5
CD4060	—	8,12	1-7,9,10,13-15	16	11	—
CD4063	—	1,2,4,8,10,11,13	5-7	3,16	12,15	9,14
CD4066	—	7	2,3,9,10	14	5,6,12,13	1,4,8,11
CD4067	—	12,15	1	24	2-9,16-23	(10,11,13,14) ¹
CD4068	6,8	7	1,13	14	2-5,9-12	—
CD4069	—	7	2,4,6,8,10,12	14	1,3,5,9,11,13	—
CD4070	—	7	3,4,10,11	14	1,5,8,12	2,6,9,13
CD4071	—	7	3,4,10,11	14	1,2,5,6,8,9,12,13	—
CD4072	6,8	7	1,13	14	2-5,9-12	—
CD4073	—	7	6,9,10	14	—	1-5,8,11-13
CD4075	—	7	6,9,10	14	—	1-5,8,11-13
CD4076	—	1,2,8-10,15	3-6	16	7	11-14
CD4077	—	7	3,4,10,11	14	1,5,8,12	2,6,9,13
CD4078	6,8	7	1,13	14	2-5,9-12	—
CD4081	—	7	3,4,10,11	14	1,2,5,6,8,9,12,13	—
CD4082	6,8	7	1,13	14	2-5,9-12	—
CD4085	—	7	3,4	14	1,2,5,6,8,9,12,13	10,11
CD4086	4	7	3	14	1,2,5,6,8,9,11-13	10
CD4089	—	2,4,8,10,12-15	1,5-7	3,16	9	11
CD4093	—	7	3,4,10,11	14	1,2,5,6,8,9,12,13	—
CD4094	—	8	4-7,9-14	1,15,16	3	2
CD4095	1	2,7,13	6,8	3-5,9-11,14	—	12
CD4096	1	2,5,7,9,13	6,8	3,4,10,11,14	12	—
CD4097	—	12,13	1,17	24	2-9,15,16,18-23	(10,11,14) ²
CD4098	—	1,4,8,12,15	6,7,9,10	2,14,16	5,11	3,13

Non-standard pin arrangement, or multiple supply pins; connect pins marked () without using a resistor.

¹Pin 10 is @ 14 kHz; pin 11 is @ 7 kHz; pin 13 is @ 1.7 kHz; pin 14 is @ 3.5 kHz.

²Pin 10 is @ 14 kHz; pin 11 is @ 7 kHz; pin 14 is @ 3.5 kHz.

High Reliability CD400B-Series CMOS ICs

Dynamic Burn-In Test Circuit Connections

TYPE	OPEN	GROUND	1/2 V _{DD}	V _{DD}	OSCILLATOR	
					50 kHz	25 kHz
CD4099	—	5-8	1,9-15	16	2,4	3
CD4502	—	8	2,5,7,9,11,14	16	4	1,3,6,10,12,13,15
CD4503	—	1,8,15	3,5,7,9,11,13	16	2,4,6,10,12,14	—
CD4504	—	8	1*,2,4,6,10,12,15	16	(3,5,7,9,11,14) ³	13 ³
CD4508	—	1,3,12,13,15	5,7,9,11,17,19,21,23	2,14,24	4,6,8,10,16,18,20,22	—
CD4510	—	1,3,4,8,9,12,13	2,6,7,11,14	10,16	15	5
CD4511	9-15	5,8	—	3,4,16	1,2,7	6
CD4512	—	8,10,15	14	16	1-7,9,11,12	13
CD4514	—	2,3,12	4-11,13-20	21,22,24	1	23
CD4515	—	2,3,12	4-11,13-20	21,22,24	1	23
CD4516	—	1,3,4,8,9,12,13	2,6,7,11,14	10,16	15	5
CD4517	—	3,8,13	1,2,5,6,10,11,14,15	16	4,12	7,9
CD4518	—	7,8,15	3-6,11-14	2,10,16	1,9	—
CD4520	—	7,8,15	3-6,11-14	2,10,16	1,9	—
CD4527	—	2,4,8,10,12-15	1,5-7	3,16	9	11
CD4532	—	8	6,7,9,14,15	5,16	1-4,10-13	—
CD4536	—	1,2,6-8,14,15	4,5,13	9-12,16	3	—
CD4541	4,11	5-7	1,2,8	9,10,12-14	3	—
CD4543	—	6-8	9-15	1,4,16	2,3,5	—
CD4555	—	1,8,15	4-7,9-12	16	2,14	3,13
CD4556	—	1,8,15	4-7,9-12	16	2,14	3,13
CD4585	—	5-9,11,14,15	3,12,13	1,4,16	2	10
CD4724	—	1-3,8	4-7,9-12	16	14,15	13
CD14538	—	1,4,8,12,15	6,7,9,10	2,14,16	5,11	3,13
CD22100	—	8	10,11,14,15	7,16	1,3,9,12,13	(2,4-6) ⁴
CD22101	—	12	4,5,8,9,16,17,20,21	24	3,6,7,10,15,18,19,22	(1,2,11,14,23) ⁵
CD40100	1,5,7,10,14,15	2,8,13	4,12	9,16	3	6,11
CD40101	—	4,7	6,9	12,14	2,3,5,8,10	1,11,13
CD40102	—	3,8,15	14	2,16	1,4,6,11,13	5,7,9,10,12
CD40103	—	3,8,15	14	2,16	1,4,6,11,13	5,7,9,10,12
CD40104	—	7,8,10	12-15	1,3-6,9,16	11	2
CD40105	—	1,8,9	2,10-14	16	3,15	4-7
CD40106	—	7	2,4,6,8,10,12	14	1,3,5,9,11,13	—
CD40107	1,2,6,8,12,13	7	5,9	14	—	3,4,10,11
CD40108	—	12	1,2,4-7,22,23	3,15,16,21,24	8,11,14,19,20	9,10,13,17,18
CD40109*	12	8	1*,4,5,11,13	16	(3,6,10,14) ⁵	(2,7,9,15) ³
CD40110	—	4-8	1-3,10-15	16	9	—
CD40116*	—	—	—	—	—	—
CD40117	—	7	3-6,8-11	14	12,13	1,2
CD40147	—	8	6,7,9,14	16	1,3,11,13	2,4,5,10,12,15
CD40160	—	8	11-15	1,7,9,10,16	2-6	—
CD40161	—	8	11-15	1,7,9,10,16	2-6	—
CD40162	—	8	11-15	1,7,9,10,16	2-6	—
CD40163	—	8	11-15	1,7,9,10,16	2-6	—
CD40174	—	8	2,5,7,10,12,15	1,16	9	3,4,6,11,13,14

*Pin Voltage is V_{DD}/2.

³Pin 5 is @ 14 kHz; Pin 6 is @ 7 kHz; Pin 2 is @ 3.5 kHz.

⁴Pin 2 is @ 14 kHz; Pin 1 is @ 7 kHz; Pins 14, 23 are @ 3.5 kHz.

⁵Non-standard pin arrangement, or multiple supply pins; connect pins marked (*) without using a resistor.

Dynamic Burn-In Test Circuit Connections

TYPE	OPEN	GROUND	1/2 V _{DD}	V _{DD}	OSCILLATOR	
					50 kHz	25 kHz
CD40175	—	8	2,3,6,7,10,11 14,15	1,16	9	4,5,12,13
CD40181	—	4-6,8,12	9-11,13-17	3,24	1,2,18-23	7
CD40182	—	8	7,9-12	16	1-6,14,15	13
CD40192	—	8,14	2,3,6,7,12,13	1,5,9-11,15,16	4	—
CD40193	—	8,14	2,3,6,7,12,13	1,5,9-11,15,16	4	—
CD40194	—	7,8,10	12-15	1,3-6,9,16	11	2
CD40208	—	12	1,2,4-7,22,23	3,15,16,21,24	8,10,14,19,20	9,11,13,17,18
CD40257	—	8,15	4,7,9,12	16	2,3,5,6,10,11, 13,14	1

Guide to Burn-In Delta Limits for Level /MS
CD400B-Series CMOS ICs

Delta Parameters

For the /MS level devices, certain parameters are data-logged and deltas are calculated from pre to post burn-in. These parameters are shown below.

Critical Parameters	Symbols	Test Conditions			Delta (Δ) Limits
		V _O (V)	V _{IN} (V)	V _{DD} (V)	
Quiescent Device Current Gates MSI-1 Types MSI-2 Types	I _{DD}	—	0,20	20	± 0.1 μ A
	I _{DD}	—	0,20	20	± 0.2 μ A
	I _{DD}	—	0,20	20	± 1.0 μ A
Output Low (Sink) Current	I _{OL}	0.4	0,5	5	± 20% of initial value
Output High (Source) Current	I _{OH}	4.6	0,5	5	± 20% of initial value
Types with R _{ON} limits instead of I _{OL} and I _{OH}	R _{ON}	—	—	10V	± 20% of initial value

High Reliability CD4000B-Series CMOS ICs

Leadless Chip Carrier Pinouts

The following table and diagrams show JEDEC standard pinout conversions from 14, 16, 22 and 24 pin leaded FP/DIL packages to 20 and 28 terminal leadless chip

carriers. Harris CD4000B-series products offered in leadless chip carriers are shown below.

Pinout Conversion From Leaded Package to Leadless-Chip Carrier

FP/DIL Pin	1	2	3	4	5	6	7	8	9	10	11	12	13	14	15	16	17	18	19	20	21	22	23	24	
Leadless	2	3	4	6	8	9	10	12	13	14	16	18	19	20											
Chip	2	3	4	5	7	8	9	10	12	13	14	15	17	18	19	20									
Carrier	2	3	4	5	6	8	10	11	12	13	14	16	17	18	19	20	22	24	25	26	27	28			
Terminal	2	3	4	5	6	7	9	10	11	12	13	14	16	17	18	19	20	21	23	24	25	26	27	28	

CD4000B-Series Conversion Diagrams

Top Views Shown

20-Terminal Leadless-Chip Carriers

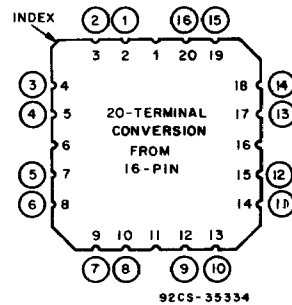
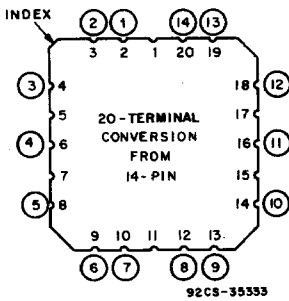

28-Terminal Leadless-Chip Carriers

