

ISSUE NUMBER	
ORIGINAL	①
ADD IN NOTES RATED CURRENT & VOLTAGE R.STA.MONICA	②
PINOUT ADDED N.SONDH	③
ADD DETAIL A P.M.	④
ADD TOTAL HEIGHT DIM 1.70 WAS 1.50 P.M.	⑤



THIS IS A C.A.D. GENERATED DRAWING
DO NOT MAKE MANUAL REVISIONS TO MASTER.

TOLERANCE UNLESS OTHERWISE SPECIFIED IN MM:
0.0 ± 0.20
0.00 ± 0.10
0.000 ± 0.05
ANGLE x°

DETAIL A

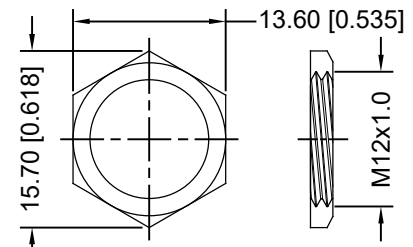
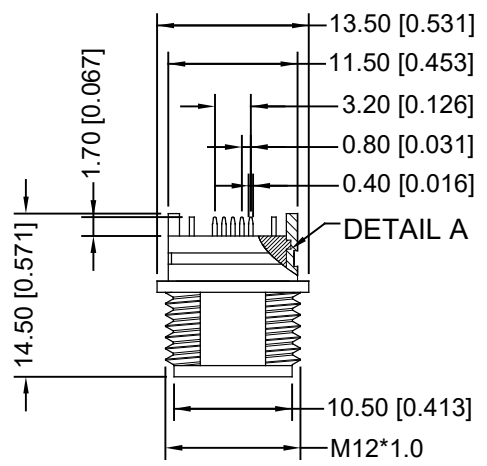
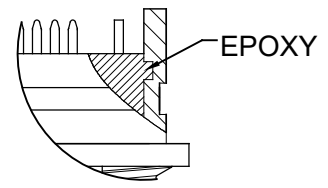

NUT

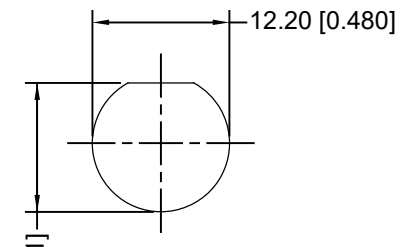

CUT OUT

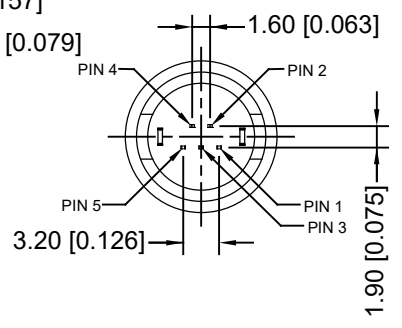
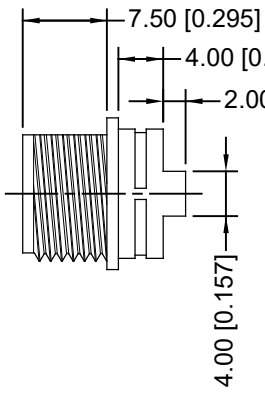
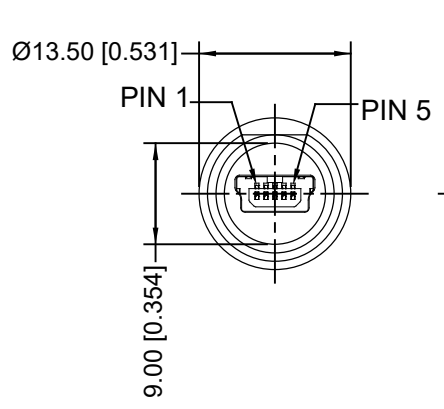
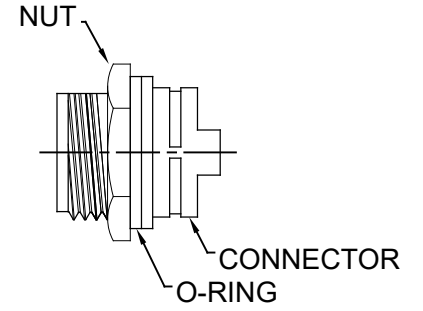

- MATERIAL :
 - 1-1 . HOUSING : LCP UL94V-0 ; COLOR : BLACK
 - 1-2 . CONTACT : PHOSPHOR BRONZE
 - 1-3 . SHELL : BRASS
- PARTS
 - 2-1 . EXTERNAL NUT : PBT UL 94V-0 ; COLOR : BLACK
 - 2-2 . O-RING : EPDM (1.5*9.5) ; COLOR : BLACK.
- PLATING
 - 3-1 . CONTACT : GOLD PLATING ON CONTACT AREA
BRIGHT TIN ON SOLDER AREA
 - 3-2 . SHELL : NICKEL PLATING ON OVER ALL
- SPECIFICATIONS :
 - 4-1. Water proof: IP67
 - 4-2. Rated Current: 1A
 - 4-3. Rated Voltage: 30V
- OPERATING TEMPERATURE:-25C TO +85C



RoHS COMPLIANT THIS SERIES FULLY CONFORMS TO THE EUROPEAN UNION DIRECTIVES 2011/65/EU FOR RoHS COMPLIANCY.

WATERPROOF MINI USB TYPE B, 5P (FEMALE)		ACAD REFERENCE NO.: 690-W05-260-044	
		DRAWN: R.STA.MONICA	DATE: MAY.01/2014
EDAC INC TORONTO, ONTARIO CANADA YOUR CONNECTION TO QUALITY & SERVICE		CHECKED: R.S.M. DATE: JAN. 21/2020	PART NUMBER 690-W05-260-044
		DRAWING NUMBER 690-W05-260-044	SHEET 1 OF 1 ISSUE 5

THESE DRAWINGS AND SPECIFICATIONS ARE THE PROPERTY OF EDAC INC., AND SHALL NOT BE REPRODUCED, OR COPIED OR USED AS THE BASIS FOR THE MANUFACTURE OR SALE OF APPARATUS WITHOUT WRITTEN PERMISSION.