

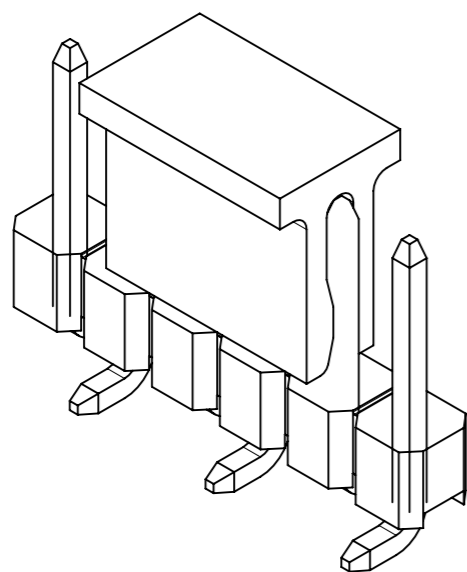

RECOMMENDED PCB LAYOUT: COMPONENT SIDE

NOTES:

1. MATERIAL:  
HSG: NYLON, GLASS-FILLED, UL94V-0, COLOR: BLACK  
CAP: NYLON, GLASS-FILLED, UL94V-0, COLOR: BLACK  
PIN: 0.64MM SQ, COPPER ALLOY
2. PLATING TYPE:  
(1) GOLD FLASH OVER  
1.25µm MIN. NICKEL OVERALL.  
(2) GOLD FLASH ON CONTACT AND  
2.50µm MIN. TIN ON SOLDER TAIL OVER  
1.25µm MIN. NICKEL OVERALL.  
(4) 0.38µm MIN. GOLD PLATE ON CONTACT AND  
2.00µm MIN. TIN ON SOLDER TAIL OVER  
1.25µm MIN. NICKEL OVERALL.  
(5) 0.75µm MIN. GOLD PLATE ON CONTACT AND  
2.00µm MIN. TIN ON SOLDER TAIL OVER  
1.25µm MIN. NICKEL OVERALL.  
(6) 2.50µm MIN. TIN OVERALL  
1.25µm MIN. NICKEL OVERALL
3. PRODUCT SPECIFICATION: PS-87920-019
4. PACKAGING TYPE: SEE TABLE
5. PACKAGING SPEC:  
TUBE WITH CAP VERSION: PK-89990-558  
TUBE W/O CAP VERSION: PK-89990-545  
TRAY W/O CAP: PK-89990-489  
EMBOSS TAPE WITH CAP: PK-89990-486 AND PK-87898-400
6. WAFER TO BE FLAT WITHIN 0.003 mm/mm
- 7 BEND DEPRESSION IS ACCEPTED SO LONG AS IT DOES NOT AFFECT THE OVERALL COPLANARITY OF TAIL
- 8 COPLANARITY IS TO BE MEASURED BY RESTING THE SOLDER TAIL ON A FLAT SURFACE
- 9 IRREGULAR CIRCUIT CUTOFF WITHIN BREAKAWAY SECTION IS PERMISSIBLE. CUTTING OR CHIPPING OF THE MAIN BODY IS NOT ACCEPTABLE
- 10 CAP LOCATION IS CENTERED ALONG THE MATING ENDS AS SHOWN. TOP SURFACE OF CAP TO BE FLAT FOR THE PURPOSE OF PICK & PLACE BY VACUUM SUCTION NOZZLE
11. RECOMMENDED PCB THICKNESS IS 1.60mm±0.10
12. THE ABOVE CKT 6 IS FOR ILLUSTRATION PURPOSE ONLY
13. TUBE LENGTH AS PER STANDARD 560mm

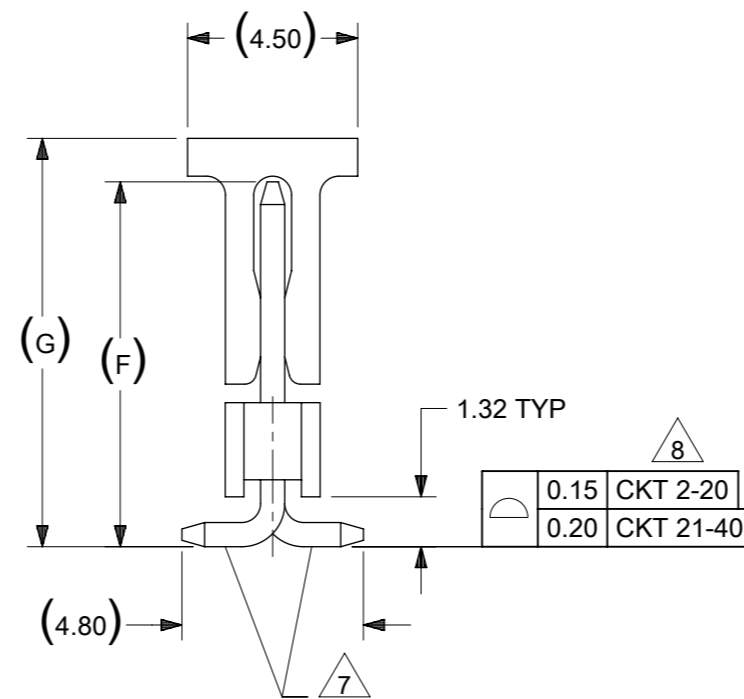
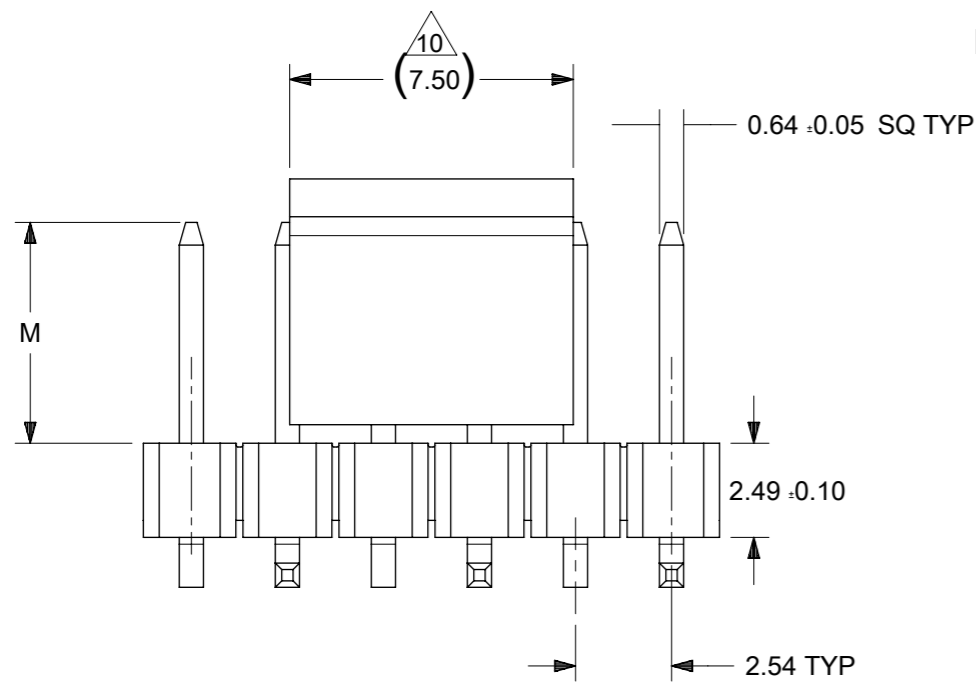

THIS DRAWING CONTAINS INFORMATION THAT IS PROPRIETARY TO MOLEX ELECTRONIC TECHNOLOGIES, LLC AND SHOULD NOT BE USED WITHOUT WRITTEN PERMISSION															
DIMENSION UNITS		SCALE		CURRENT REV DESC:											
mm		NTS													
GENERAL TOLERANCES (UNLESS SPECIFIED)				EC NO: 745488 DRWN: SUAIFR 2023/02/15 CHK'D: SUAIFR 2023/04/10 APPR: MRAMAKRISHNA 2023/04/10 INITIAL REVISION: DRWN: GGUNAGI 2016/11/09 APPR: ISHWARG 2016/12/06						CUSTOMER		REVISION			
										DOCUMENT NUMBER		DOC TYPE		DOC PART	
										SD-87898-001		PSD		000 B26	
										MATERIAL NUMBER		CUSTOMER		SHEET NUMBER	
										SEE TABLE		GENERAL MARKET		1 OF 21	

PACKAGING OPTION PART NO.						CKT SIZE	VOID POSITION	PLATING TYPE	DIMENSION					CAP (SEE SHEET-16)
TRAY WITHOUT CAP	TRAY WITH CAP	TUBE WITHOUT CAP	TUBE WITH CAP	TAPE & REEL WITHOUT CAP	TAPE & REEL WITH CAP				A	B	G	F	M	
87898-0301	-----	-----	-----	-----	-----	3	----	1	7.62	5.08	10.81	9.65	5.84	1
87898-0302	-----	-----	-----	-----	-----	3	----	2	7.62	5.08	10.81	9.65	5.84	1
87898-0304	-----	-----	-----	-----	87898-0314	3	----	4	7.62	5.08	10.81	9.65	5.84	1
87898-0305	-----	-----	-----	-----	87898-0315	3	----	5	7.62	5.08	10.81	9.65	5.84	1
87898-0306	-----	-----	-----	-----	87898-0316	3	----	6	7.62	5.08	10.81	9.65	5.84	1
87898-0307	-----	-----	-----	-----	87898-0320	3	----	6	7.62	5.08	10.81	9.65	5.84	1
-----	-----	-----	-----	-----	87898-0317	3	-----	6	7.62	5.08	10.81	9.65	5.84	1
-----	-----	-----	-----	-----	87898-0321	3	-----	6	7.62	5.08	10.81	9.65	5.84	1
-----	-----	-----	-----	-----	87898-0318	3	----	5	7.62	5.08	10.81	9.65	5.84	1
-----	-----	-----	-----	-----	87898-0310	3	-----	6	7.62	5.08	14.91	13.91	10.10	1
-----	-----	-----	-----	-----	87898-0309	3	-----	6	7.62	5.08	14.81	13.81	10.00	1
-----	-----	87898-0370	-----	-----	-----	3	-----	6	7.62	5.08	----	13.91	10.10	1

REFER TO LAST SHEET FOR 2CKT SIZE



THIS DRAWING CONTAINS INFORMATION THAT IS PROPRIETARY TO MOLEX ELECTRONIC TECHNOLOGIES, LLC AND SHOULD NOT BE USED WITHOUT WRITTEN PERMISSION																	
DIMENSION UNITS		SCALE		CURRENT REV DESC:													
mm		NTS															
GENERAL TOLERANCES (UNLESS SPECIFIED)				EC NO: 745488 DRWN: SUAIFR 2023/02/15 CHK'D: SUAIFR 2023/04/10 APPR: MRAMAKRISHNA 2023/04/10 INITIAL REVISION: DRWN: GGUNAGI 2016/11/09 APPR: ISHWARG 2016/12/06						CUSTOM HEADER							
										2.54MM PITCH SINGLE ROW SINGLE WAFER SMT HEADER							
										PRODUCT CUSTOMER DRAWING							
										DOCUMENT NUMBER		DOC TYPE		DOC PART		REVISION	
										SD-87898-001		PSD		000		B26	
DRAFT WHERE APPLICABLE MUST REMAIN WITHIN DIMENSIONS				THIRD ANGLE PROJECTION		DRAWING		SERIES		MATERIAL NUMBER		CUSTOMER		SHEET NUMBER			
						A3-SIZE		87898		SEE TABLE		GENERAL MARKET		2 OF 21			

DOCUMENT STATUS	P1	RELEASE DATE	2023/04/10	07:46:21
-----------------	----	--------------	------------	----------

10		9		8		7		6		5		4		3		2		1	
PACKAGING OPTION PART NO.						CKT SIZE	VOID POSITION	PLATING TYPE	MODIFIED MATING CKT	MODIFIED MATING LENGTH	DIMENSION					CAP (SEE SHEET-16)			
TRAY WITHOUT CAP	TRAY WITH CAP	TUBE WITHOUT CAP	TUBE WITH CAP	TAPE & REEL WITHOUT CAP	TAPE & REEL WITH CAP						A	B	G	F	M				
F	-----	-----	87898-0421	87898-0431	-----	87898-0451	4	-----	1	-----	-----	10.16	7.62	10.81	9.65	5.84	1		
	-----	-----	87898-0422	87898-0432	-----	87898-0452	4	-----	2	-----	-----	10.16	7.62	10.81	9.65	5.84	1		
	-----	-----	87898-0424	87898-0434	-----	87898-0454	4	-----	4	-----	-----	10.16	7.62	10.81	9.65	5.84	1		
	-----	-----	87898-0425	87898-0435	-----	87898-0455	4	-----	5	-----	-----	10.16	7.62	10.81	9.65	5.84	1		
	-----	-----	87898-0426	87898-0436	-----	87898-0456	4	-----	6	-----	-----	10.16	7.62	10.81	9.65	5.84	1		
	-----	-----	87898-0428	87898-0437	-----	87898-0460	4	-----	6	-----	-----	10.16	7.62	10.81	9.65	5.84	1		
	-----	-----	-----	-----	-----	87898-0457	4	-----	6	-----	-----	10.16	7.62	10.81	9.65	5.84	1		
	-----	-----	-----	-----	-----	87898-0458	4	-----	5	-----	-----	10.16	7.62	10.81	9.65	5.84	1		
	-----	-----	-----	-----	-----	87898 - 0480	4	CKT# 4	5	-----	-----	10.16	7.62	14.70	13.65	9.84	1		
	-----	-----	-----	-----	-----	87898 - 0481	4	-----	5	CKT # 1, 2 & 3	1.00	10.16	7.62	17.70	16.65	12.84	1		
E	87898 - 0482	-----	-----	-----	-----	-----	4	-----	---	CKT # 1, 2 & 3	1.00	10.16	7.62	---	16.65	12.84	1		
	-----	-----	-----	-----	-----	87898 - 0483	4	-----	---	CKT # 1, 2 & 3	1.00	10.16	7.62	14.70	13.65	9.84	1		
	-----	-----	87898-0427	-----	-----	-----	4	-----	---	-----	-----	10.16	7.62	---	11.87	8.06	1		
	-----	-----	-----	-----	-----	87898 - 0488	4	-----	5	-----	-----	10.16	7.62	17.78	16.74	12.93	1		
	-----	-----	87898-0521	87898-0531	-----	87898-0551	5	-----	1	-----	-----	12.70	10.16	10.81	9.65	5.84	1		
	-----	-----	87898-0522	87898-0532	-----	87898-0552	5	-----	2	-----	-----	12.70	10.16	10.81	9.65	5.84	1		
	-----	-----	87898-0524	87898-0534	-----	87898-0554	5	-----	4	-----	-----	12.70	10.16	10.81	9.65	5.84	1		
	-----	-----	87898-0525	87898-0535	-----	87898-0555	5	-----	5	-----	-----	12.70	10.16	10.81	9.65	5.84	1		
D	-----	-----	87898-0526	87898-0536	87898-0583	87898-0556	5	-----	6	-----	-----	12.70	10.16	10.81	9.65	5.84	1		
	-----	-----	87898-0528	87898-0538	87898-0584	87898-0558	5	-----	6	-----	-----	12.70	10.16	10.81	9.65	5.84	1		
	87898-0581	-----	-----	-----	-----	-----	5	-----	4	-----	-----	12.70	10.16	---	24.18	20.25	1		
	-----	-----	-----	-----	-----	87898-0576	5	-----	5	-----	-----	12.70	10.16	14.35	13.31	9.50	1		
	-----	-----	87898-0621	87898-0631	-----	87898-0651	6	-----	1	-----	-----	15.24	12.70	10.81	9.65	5.84	1		
	-----	-----	87898-0622	87898-0632	-----	87898-0652	6	-----	2	-----	-----	15.24	12.70	10.81	9.65	5.84	1		
	-----	-----	87898-0624	87898-0634	-----	87898-0654	6	-----	4	-----	-----	15.24	12.70	10.81	9.65	5.84	1		
	-----	-----	87898-0625	87898-0635	-----	87898-0655	6	-----	5	-----	-----	15.24	12.70	10.81	9.65	5.84	1		
C	-----	-----	87898-0626	87898-0636	-----	87898-0656	6	-----	6	-----	-----	15.24	12.70	10.81	9.65	5.84	1		
	-----	-----	87898-0628	87898-0638	-----	87898-0658	6	-----	6	-----	-----	15.24	12.70	10.81	9.65	5.84	1		
	87898-0607	-----	-----	-----	-----	87898-0657	6	-----	6	-----	-----	15.24	12.70	16.47	15.31	11.50	1		
	-----	-----	-----	-----	-----	87898-0605	6	-----	5	-----	-----	15.24	12.70	12.98	11.94	8.13	1		
	-----	-----	87898-0604	-----	-----	-----	6	-----	5	-----	-----	15.24	12.70	---	13.31	9.50	1		

B		B		B		B		B		B		B		B		B		B	
A		A		A		A		A		A		A		A		A		A	

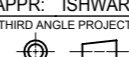
THIS DRAWING CONTAINS INFORMATION THAT IS PROPRIETARY TO MOLEX ELECTRONIC TECHNOLOGIES, LLC AND SHOULD NOT BE USED WITHOUT WRITTEN PERMISSION															
DIMENSION UNITS		SCALE		CURRENT REV DESC:						 CUSTOM HEADER 2.54MM PITCH SINGLE ROW SINGLE WAFER SMT HEADER					
mm		NTS													
GENERAL TOLERANCES (UNLESS SPECIFIED)				MM		INCH		EC NO: 745488				2023/02/15			
4 PLACES		±		±		DRWN: SUAIFR				2023/04/10					
3 PLACES		±		±		CHK'D: SUAIFR				2023/04/10					
2 PLACES		± 0.2		±		APPR: MRAMAKRISHNA				2023/04/10					
1 PLACE		±		±		INITIAL REVISION:									
0 PLACES		±		±		DRWN: GGUNAGI				2016/11/09					
ANGULAR TOL		± 3.0°		±		APPR: ISHWARG				2016/12/06					
DRAFT WHERE APPLICABLE MUST REMAIN WITHIN DIMENSIONS				THIRD ANGLE PROJECTION		DRAWING		SERIES		MATERIAL NUMBER		CUSTOMER		SHEET NUMBER	
						A3-SIZE		87898		SEE TABLE		GENERAL MARKET		3 OF 21	

DOCUMENT STATUS	P1	RELEASE DATE	2023/04/10	07:46:21
-----------------	----	--------------	------------	----------

10		9		8		7		6		5		4		3		2		1	
PACKAGING OPTION PART NO.						CKT SIZE	VOID POSITION	PLATING TYPE	DIMENSION					CAP (SEE SHEET-16)					
TRAY WITHOUT CAP	TRAY WITH CAP	TUBE WITHOUT CAP	TUBE WITH CAP	TAPE & REEL WITHOUT CAP	TAPE & REEL WITH CAP				A	B	G	F	M						
-----	-----	87898-0721	87898-0731	-----	87898-0751	7	-----	1	17.78	15.24	10.81	9.65	5.84	1					
-----	-----	87898-0722	87898-0732	-----	87898-0752	7	-----	2	17.78	15.24	10.81	9.65	5.84	1					
-----	-----	87898-0724	87898-0734	-----	87898-0754	7	-----	4	17.78	15.24	10.81	9.65	5.84	1					
-----	-----	87898-0725	87898-0735	-----	87898-0755	7	-----	5	17.78	15.24	10.81	9.65	5.84	1					
-----	-----	87898-0726	87898-0736	-----	87898-0756	7	-----	6	17.78	15.24	10.81	9.65	5.84	1					
-----	-----	87898-0727	87898-0737	-----	87898-0758	7	-----	6	17.78	15.24	10.81	9.65	5.84	1					
-----	-----	-----	-----	87898-0757	-----	7	-----	6	17.78	15.24	---	9.65	5.84	1					
-----	-----	-----	-----	87898-0759	-----	7	-----	6	17.78	15.24	---	9.65	5.84	1					
-----	-----	87898-0720	-----	-----	-----	7	-----	5	17.78	15.24	---	9.81	6.00	1					
-----	-----	87898-0767	-----	-----	-----	7	-----	5	17.78	15.24	---	13.81	10.00	1					
-----	-----	87898-0821	87898-0831	-----	87898-0851	8	-----	1	20.32	17.78	10.81	9.65	5.84	1					
-----	-----	87898-0822	87898-0832	-----	87898-0852	8	-----	2	20.32	17.78	10.81	9.65	5.84	1					
-----	-----	87898-0824	87898-0834	-----	87898-0854	8	-----	4	20.32	17.78	10.81	9.65	5.84	1					
-----	-----	87898-0825	87898-0835	-----	87898-0855	8	-----	5	20.32	17.78	10.81	9.65	5.84	1					
-----	-----	87898-0826	87898-0836	-----	87898-0856	8	-----	6	20.32	17.78	10.81	9.65	5.84	1					
-----	-----	87898-0827	87898-0837	-----	87898-0857	8	-----	6	20.32	17.78	10.81	9.65	5.84	1					
87898-0881	-----	-----	-----	-----	-----	8	-----	4	20.32	17.78	---	21.84	17.91	1					
-----	-----	87898-0921	87898-0931	-----	87898-0951	9	-----	1	22.86	20.32	10.81	9.65	5.84	1					
-----	-----	87898-0922	87898-0932	-----	87898-0952	9	-----	2	22.86	20.32	10.81	9.65	5.84	1					
-----	-----	87898-0924	87898-0934	-----	87898-0954	9	-----	4	22.86	20.32	10.81	9.65	5.84	1					
-----	-----	87898-0925	87898-0935	-----	87898-0955	9	-----	5	22.86	20.32	10.81	9.65	5.84	1					
-----	-----	87898-0926	87898-0936	-----	87898-0956	9	-----	6	22.86	20.32	10.81	9.65	5.84	1					

THIS DRAWING CONTAINS INFORMATION THAT IS PROPRIETARY TO MOLEX ELECTRONIC TECHNOLOGIES, LLC AND SHOULD NOT BE USED WITHOUT WRITTEN PERMISSION									
DIMENSION UNITS		SCALE		CURRENT REV DESC:					
mm		NTS		 <b>CUSTOM HEADER</b> 2.54MM PITCH SINGLE ROW SINGLE WAFER SMT HEADER <b>PRODUCT CUSTOMER DRAWING</b>					
GENERAL TOLERANCES (UNLESS SPECIFIED)									
		MM	INCH						
4 PLACES	±		±						
3 PLACES	±		±						
2 PLACES	±	0.2	±						
1 PLACE	±		±						
0 PLACES	±		±						
ANGULAR TOL		± 3.0°		EC NO: 745488		2023/02/15		2023/04/10	
DRAFT WHERE APPLICABLE MUST REMAIN WITHIN DIMENSIONS		THIRD ANGLE PROJECTION		DRAWING		SERIES		MATERIAL NUMBER	
				A3-SIZE		87898		SEE TABLE	
DOCUMENT STATUS		P1	RELEASE DATE	2023/04/10 07:46:21		DOCUMENT NUMBER		DOC TYPE	
						SD-87898-001		PSD	
						2016/11/09		DOC PART	
						2016/12/06		REVISION	
								000 B26	
								4 OF 21	

PACKAGING OPTION PART NO.										DIMENSION					CAP (SEE SHEET-16)
TRAY WITHOUT CAP	TRAY WITH CAP	TUBE WITHOUT CAP	TUBE WITH CAP	TAPE & REEL WITHOUT CAP	TAPE & REEL WITH CAP	CKT SIZE	VOID POSITION	PLATING TYPE	A	B	G	F	M		
-----	-----	87898-1021	87898-1031	-----	87898-1051	10	-----	1	25.40	22.86	10.81	9.65	5.84	1	
-----	-----	87898-1022	87898-1032	-----	87898-1052	10	-----	2	25.40	22.86	10.81	9.65	5.84	1	
-----	-----	87898-1024	87898-1034	-----	87898-1054	10	-----	4	25.40	22.86	10.81	9.65	5.84	1	
-----	-----	87898-1025	87898-1035	-----	87898-1055	10	-----	5	25.40	22.86	10.81	9.65	5.84	1	
-----	-----	87898-1026	87898-1036	-----	87898-1056	10	-----	6	25.40	22.86	10.81	9.65	5.84	1	
-----	-----	87898-1027	87898-1037	-----	87898-1057	10	-----	6	25.40	22.86	10.81	9.65	5.84	1	
-----	-----	87898-1003	-----	-----	-----	10	-----	5	25.40	22.86	---	9.81	6.00	1	
-----	-----	87898-1121	87898-1131	-----	87898-1151	11	-----	1	27.94	25.40	10.81	9.65	5.84	1	
-----	-----	87898-1122	87898-1132	-----	87898-1152	11	-----	2	27.94	25.40	10.81	9.65	5.84	1	
-----	-----	87898-1124	87898-1134	-----	87898-1154	11	-----	4	27.94	25.40	10.81	9.65	5.84	1	
-----	-----	87898-1125	87898-1135	-----	87898-1155	11	-----	5	27.94	25.40	10.81	9.65	5.84	1	
-----	-----	87898-1126	87898-1136	-----	87898-1156	11	-----	6	27.94	25.40	10.81	9.65	5.84	1	
-----	-----	87898-1221	87898-1231	-----	87898-1251	12	-----	1	30.48	27.94	10.81	9.65	5.84	1	
-----	-----	87898-1222	87898-1232	-----	87898-1252	12	-----	2	30.48	27.94	10.81	9.65	5.84	1	
-----	-----	87898-1224	87898-1234	-----	87898-1254	12	-----	4	30.48	27.94	10.81	9.65	5.84	1	
-----	-----	87898-1225	87898-1235	-----	87898-1255	12	-----	5	30.48	27.94	10.81	9.65	5.84	1	
-----	-----	87898-1226	87898-1236	-----	87898-1256	12	-----	6	30.48	27.94	10.81	9.65	5.84	1	

THIS DRAWING CONTAINS INFORMATION THAT IS PROPRIETARY TO MOLEX ELECTRONIC TECHNOLOGIES, LLC AND SHOULD NOT BE USED WITHOUT WRITTEN PERMISSION

DIMENSION UNITS	SCALE	CURRENT REV DESC:	<b>molex</b>			
mm	NTS					
GENERAL TOLERANCES (UNLESS SPECIFIED)		EC NO: 745488 DRWN: SUAIFR CHK'D: SUAIFR APPR: MRAMAKRISHNA INITIAL REVISION: DRWN: GGUNAGI APPR: ISHWARG	2023/02/15 2023/04/10 2023/04/10 2016/11/09 2016/12/06			
	MM INCH					
4 PLACES	± ±					
3 PLACES	± ±					
2 PLACES	± 0.2 ±					
1 PLACE	± ±					
0 PLACES	± ±	DOCUMENT NUMBER	DOC TYPE	DOC PART	REVISION	
ANGULAR TOL	± 3.0°	SD-87898-001	PSD	000	B26	
DRAFT WHERE APPLICABLE MUST REMAIN WITHIN DIMENSIONS	THIRD ANGLE PROJECTION	DRAWING	SERIES	MATERIAL NUMBER	CUSTOMER	SHEET NUMBER
		A3-SIZE	87898	SEE TABLE	GENERAL MARKET	5 OF 21

DOCUMENT STATUS	P1	RELEASE DATE	2023/04/10	07:46:21
-----------------	----	--------------	------------	----------

10		9		8		7		6		5		4		3		2		1	
PACKAGING OPTION PART NO.						CKT SIZE	VOID POSITION	PLATING TYPE	DIMENSION					CAP (SEE SHEET-16)					
TRAY WITHOUT CAP	TRAY WITH CAP	TUBE WITHOUT CAP	TUBE WITH CAP	TAPE & REEL WITHOUT CAP	TAPE & REEL WITH CAP				A	B	G	F	M						
-----	-----	87898-1321	87898-1331	-----	87898-1351	13	-----	1	33.02	30.48	10.81	9.65	5.84	1					
-----	-----	87898-1322	87898-1332	-----	87898-1352	13	-----	2	33.02	30.48	10.81	9.65	5.84	1					
-----	-----	87898-1324	87898-1334	-----	87898-1354	13	-----	4	33.02	30.48	10.81	9.65	5.84	1					
-----	-----	87898-1325	87898-1335	-----	87898-1355	13	-----	5	33.02	30.48	10.81	9.65	5.84	1					
-----	-----	87898-1326	87898-1336	-----	87898-1356	13	-----	6	33.02	30.48	10.81	9.65	5.84	1					
-----	-----	87898-1421	87898-1431	-----	87898-1451	14	-----	1	35.56	33.02	10.81	9.65	5.84	1					
-----	-----	87898-1422	87898-1432	-----	87898-1452	14	-----	2	35.56	33.02	10.81	9.65	5.84	1					
-----	-----	87898-1424	87898-1434	-----	87898-1454	14	-----	4	35.56	33.02	10.81	9.65	5.84	1					
-----	-----	87898-1425	87898-1435	-----	87898-1455	14	-----	5	35.56	33.02	10.81	9.65	5.84	1					
-----	-----	87898-1426	87898-1436	-----	87898-1456	14	-----	6	35.56	33.02	10.81	9.65	5.84	1					
-----	-----	87898-1427	87898-1437	-----	87898-1457	14	-----	6	35.56	33.02	10.81	9.65	5.84	1					
-----	-----	87898-1521	87898-1531	-----	87898-1551	15	-----	1	38.10	35.56	10.81	9.65	5.84	1					
-----	-----	87898-1522	87898-1532	-----	87898-1552	15	-----	2	38.10	35.56	10.81	9.65	5.84	1					
-----	-----	87898-1524	87898-1534	-----	87898-1554	15	-----	4	38.10	35.56	10.81	9.65	5.84	1					
-----	-----	87898-1525	87898-1535	-----	87898-1555	15	-----	5	38.10	35.56	10.81	9.65	5.84	1					
-----	-----	87898-1526	87898-1536	-----	87898-1556	15	-----	6	38.10	35.56	10.81	9.65	5.84	1					

THIS DRAWING CONTAINS INFORMATION THAT IS PROPRIETARY TO MOLEX ELECTRONIC TECHNOLOGIES, LLC AND SHOULD NOT BE USED WITHOUT WRITTEN PERMISSION																			
DIMENSION UNITS		SCALE		CURRENT REV DESC:															
mm		NTS		<p style="text-align: center;"><b>molex</b></p> <p style="text-align: center;">CUSTOM HEADER 2.54MM PITCH SINGLE ROW SINGLE WAFER SMT HEADER</p> <p style="text-align: center;">PRODUCT CUSTOMER DRAWING</p>															
GENERAL TOLERANCES (UNLESS SPECIFIED)																			
		MM													INCH				
4 PLACES	±		±																
3 PLACES	±		±																
2 PLACES	±	0.2	±																
1 PLACE	±		±																
0 PLACES	±		±																
ANGULAR TOL		± 3.0°		EC NO: 745488 DRWN: SUAIFR APPR: MRAMAKRISHNA INITIAL REVISION: DRWN: GGUNAGI APPR: ISHWARG															
DRAFT WHERE APPLICABLE MUST REMAIN WITHIN DIMENSIONS		THIRD ANGLE PROJECTION		DRAWING		SERIES		MATERIAL NUMBER		CUSTOMER		DOCUMENT NUMBER		DOC TYPE		DOC PART		REVISION	
				A3-SIZE		87898		SEE TABLE		GENERAL MARKET		SD-87898-001		PSD		000		B26	
DOCUMENT STATUS		P1		RELEASE DATE		2023/04/10		07:46:21											

PACKAGING OPTION PART NO.										DIMENSION					CAP (SEE SHEET-16)
TRAY WITHOUT CAP	TRAY WITH CAP	TUBE WITHOUT CAP	TUBE WITH CAP	TAPE & REEL WITHOUT CAP	TAPE & REEL WITH CAP	CKT SIZE	VOID POSITION	PLATING TYPE	A	B	G	F	M		
-----	-----	87898-1621	87898-1631	-----	87898-1651	16	-----	1	40.64	38.10	10.81	9.65	5.84	1	
-----	-----	87898-1622	87898-1632	-----	87898-1652	16	-----	2	40.64	38.10	10.81	9.65	5.84	1	
-----	-----	87898-1624	87898-1634	-----	87898-1654	16	-----	4	40.64	38.10	10.81	9.65	5.84	1	
-----	-----	87898-1625	87898-1635	-----	87898-1655	16	-----	5	40.64	38.10	10.81	9.65	5.84	1	
-----	-----	87898-1626	87898-1636	-----	87898-1656	16	-----	6	40.64	38.10	10.81	9.65	5.84	1	
-----	-----	87898-1627	87898-1637	-----	87898-1657	16	-----	6	40.64	38.10	10.81	9.65	5.84	1	
-----	-----	87898-1721	87898-1731	-----	87898-1751	17	-----	1	43.18	40.64	10.81	9.65	5.84	1	
-----	-----	87898-1722	87898-1732	-----	87898-1752	17	-----	2	43.18	40.64	10.81	9.65	5.84	1	
-----	-----	87898-1724	87898-1734	-----	87898-1754	17	-----	4	43.18	40.64	10.81	9.65	5.84	1	
-----	-----	87898-1725	87898-1735	-----	87898-1755	17	-----	5	43.18	40.64	10.81	9.65	5.84	1	
-----	-----	87898-1726	87898-1736	-----	87898-1756	17	-----	6	43.18	40.64	10.81	9.65	5.84	1	
-----	-----	87898-1821	87898-1831	-----	87898-1851	18	-----	1	45.72	43.18	10.81	9.65	5.84	1	
-----	-----	87898-1822	87898-1832	-----	87898-1852	18	-----	2	45.72	43.18	10.81	9.65	5.84	1	
-----	-----	87898-1824	87898-1834	-----	87898-1854	18	-----	4	45.72	43.18	10.81	9.65	5.84	1	
-----	-----	87898-1825	87898-1835	-----	87898-1855	18	-----	5	45.72	43.18	10.81	9.65	5.84	1	
-----	-----	87898-1826	87898-1836	-----	87898-1856	18	-----	6	45.72	43.18	10.81	9.65	5.84	1	
-----	-----	87898-1827	87898-1837	-----	87898-1857	18	-----	6	45.72	43.18	10.81	9.65	5.84	1	

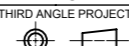
THIS DRAWING CONTAINS INFORMATION THAT IS PROPRIETARY TO MOLEX ELECTRONIC TECHNOLOGIES, LLC AND SHOULD NOT BE USED WITHOUT WRITTEN PERMISSION													
DIMENSION UNITS		SCALE		CURRENT REV DESC:									
mm		NTS											
GENERAL TOLERANCES (UNLESS SPECIFIED)				EC NO: 745488 DRWN: SUAIFR APPR: MRAMAKRISHNA INITIAL REVISION: DRWN: GGUNAGI APPR: ISHWARG				CUSTOM HEADER 2.54MM PITCH SINGLE ROW SINGLE WAFER SMT HEADER					
								PRODUCT CUSTOMER DRAWING					
								DOCUMENT NUMBER		DOC TYPE		DOC PART	
								SD-87898-001		PSD		000 B26	
				SERIES		MATERIAL NUMBER		CUSTOMER					
				A3-SIZE		87898		GENERAL MARKET					
DRAFT WHERE APPLICABLE MUST REMAIN WITHIN DIMENSIONS				THIRD ANGLE PROJECTION		DRAWING		SHEET NUMBER					
						A3-SIZE		7 OF 21					

DOCUMENT STATUS	P1	RELEASE DATE	2023/04/10	07:46:21
-----------------	----	--------------	------------	----------

10		9		8		7		6		5		4		3		2		1	
PACKAGING OPTION PART NO.														CAP (SEE SHEET-16)					
TRAY WITHOUT CAP	TRAY WITH CAP	TUBE WITHOUT CAP	TUBE WITH CAP	TAPE & REEL WITHOUT CAP	TAPE & REEL WITH CAP	CKT SIZE	VOID POSITION	PLATING TYPE	DIMENSION										
									A	B	G	F	M						
-----	-----	87898-1921	87898-1931	-----	87898-1951	19	-----	1	48.26	45.72	10.81	9.65	5.84	1					
-----	-----	87898-1922	87898-1932	-----	87898-1952	19	-----	2	48.26	45.72	10.81	9.65	5.84	1					
-----	-----	87898-1924	87898-1934	-----	87898-1954	19	-----	4	48.26	45.72	10.81	9.65	5.84	1					
-----	-----	87898-1925	87898-1935	-----	87898-1955	19	-----	5	48.26	45.72	10.81	9.65	5.84	1					
-----	-----	87898-1926	87898-1936	-----	87898-1956	19	-----	6	48.26	45.72	10.81	9.65	5.84	1					
-----	-----	87898-2021	87898-2031	-----	87898-2051	20	-----	1	50.80	48.26	10.81	9.65	5.84	1					
-----	-----	87898-2022	87898-2032	-----	87898-2052	20	-----	2	50.80	48.26	10.81	9.65	5.84	1					
-----	-----	87898-2024	87898-2034	-----	87898-2054	20	-----	4	50.80	48.26	10.81	9.65	5.84	1					
-----	-----	87898-2025	87898-2035	-----	87898-2055	20	-----	5	50.80	48.26	10.81	9.65	5.84	1					
-----	-----	87898-2026	87898-2036	-----	87898-2056	20	-----	6	50.80	48.26	10.81	9.65	5.84	1					
-----	-----	87898-2027	87898-2037	-----	87898-2057	20	-----	6	50.80	48.26	10.81	9.65	5.84	1					
-----	-----	87898-2121	87898-2131	-----	87898-2151	21	-----	1	53.34	50.80	10.81	9.65	5.84	1					
-----	-----	87898-2122	87898-2132	-----	87898-2152	21	-----	2	53.34	50.80	10.81	9.65	5.84	1					
-----	-----	87898-2124	87898-2134	-----	87898-2154	21	-----	4	53.34	50.80	10.81	9.65	5.84	1					
-----	-----	87898-2125	87898-2135	-----	87898-2155	21	-----	5	53.34	50.80	10.81	9.65	5.84	1					
-----	-----	87898-2126	87898-2136	-----	87898-2156	21	-----	6	53.34	50.80	10.81	9.65	5.84	1					

THIS DRAWING CONTAINS INFORMATION THAT IS PROPRIETARY TO MOLEX ELECTRONIC TECHNOLOGIES, LLC AND SHOULD NOT BE USED WITHOUT WRITTEN PERMISSION																	
DIMENSION UNITS		SCALE		CURRENT REV DESC:													
mm		NTS		<p style="text-align: center;"><b>molex</b></p> <p style="text-align: center;">CUSTOM HEADER 2.54MM PITCH SINGLE ROW SINGLE WAFER SMT HEADER</p> <p style="text-align: center;">PRODUCT CUSTOMER DRAWING</p>													
GENERAL TOLERANCES (UNLESS SPECIFIED)																	
		MM												INCH			
4 PLACES	±		±														
3 PLACES	±		±														
2 PLACES	±	0.2	±														
1 PLACE	±		±														
0 PLACES	±		±														
ANGULAR TOL ± 3.0°				DRAFT WHERE APPLICABLE MUST REMAIN WITHIN DIMENSIONS		THIRD ANGLE PROJECTION		DRAWING		SERIES		MATERIAL NUMBER		CUSTOMER		SHEET NUMBER	
				A3-SIZE		87898		SEE TABLE		GENERAL MARKET		8 OF 21					

DOCUMENT STATUS	P1	RELEASE DATE	2023/04/10	07:46:21
-----------------	----	--------------	------------	----------



10		9		8		7		6		5		4		3		2		1	
PACKAGING OPTION PART NO.														CAP (SEE SHEET-16)					
TRAY WITHOUT CAP	TRAY WITH CAP	TUBE WITHOUT CAP	TUBE WITH CAP	TAPE & REEL WITHOUT CAP	TAPE & REEL WITH CAP	CKT SIZE	VOID POSITION	PLATING TYPE	DIMENSION										
									A	B	G	F	M						
-----	-----	87898-2221	87898-2231	-----	-----	22	----	1	55.88	53.34	10.81	9.65	5.84	1					
-----	-----	87898-2222	87898-2232	-----	-----	22	----	2	55.88	53.34	10.81	9.65	5.84	1					
-----	-----	87898-2224	87898-2234	-----	-----	22	----	4	55.88	53.34	10.81	9.65	5.84	1					
-----	-----	87898-2225	87898-2235	-----	-----	22	----	5	55.88	53.34	10.81	9.65	5.84	1					
-----	-----	87898-2226	87898-2236	-----	-----	22	----	6	55.88	53.34	10.81	9.65	5.84	1					
-----	-----	87898-2321	87898-2331	-----	-----	23	----	1	58.42	55.88	10.81	9.65	5.84	1					
-----	-----	87898-2322	87898-2332	-----	-----	23	----	2	58.42	55.88	10.81	9.65	5.84	1					
-----	-----	87898-2324	87898-2334	-----	-----	23	----	4	58.42	55.88	10.81	9.65	5.84	1					
-----	-----	87898-2325	87898-2335	-----	-----	23	----	5	58.42	55.88	10.81	9.65	5.84	1					
-----	-----	87898-2326	87898-2336	-----	-----	23	----	6	58.42	55.88	10.81	9.65	5.84	1					
-----	-----	87898-2421	87898-2431	-----	-----	24	----	1	60.96	58.42	10.81	9.65	5.84	1					
-----	-----	87898-2422	87898-2432	-----	-----	24	----	2	60.96	58.42	10.81	9.65	5.84	1					
-----	-----	87898-2424	87898-2434	-----	-----	24	----	4	60.96	58.42	10.81	9.65	5.84	1					
-----	-----	87898-2425	87898-2435	-----	-----	24	----	5	60.96	58.42	10.81	9.65	5.84	1					
-----	-----	87898-2426	87898-2436	-----	-----	24	----	6	60.96	58.42	10.81	9.65	5.84	1					
-----	-----	87898-2427	87898-2437	-----	-----	24	----	6	60.96	58.42	10.81	9.65	5.84	1					

THIS DRAWING CONTAINS INFORMATION THAT IS PROPRIETARY TO MOLEX ELECTRONIC TECHNOLOGIES, LLC AND SHOULD NOT BE USED WITHOUT WRITTEN PERMISSION													
DIMENSION UNITS		SCALE		CURRENT REV DESC:									
mm		NTS		<b>molex</b> CUSTOM HEADER 2.54MM PITCH SINGLE ROW SINGLE WAFER SMT HEADER PRODUCT CUSTOMER DRAWING									
GENERAL TOLERANCES (UNLESS SPECIFIED)													
		MM	INCH										
4 PLACES	±		±										
3 PLACES	±		±										
2 PLACES	±	0.2	±										
1 PLACE	±		±										
0 PLACES	±		±										
ANGULAR TOL ± 3.0°				EC NO: 745488		DRWN: SUIAIFR		2023/02/15		CHK'D: SUIAIFR		2023/04/10	
DRAFT WHERE APPLICABLE MUST REMAIN WITHIN DIMENSIONS				APP'R: MRAMAKRISHNA		2023/04/10		INITIAL REVISION:		DRWN: GGUNAGI		2016/11/09	
				APP'R: ISHWARG		2016/12/06		DOCUMENT NUMBER		SD-87898-001		DOC TYPE DOC PART REVISION	
				THIRD ANGLE PROJECTION		DRAWING		SERIES		MATERIAL NUMBER		CUSTOMER	
				A3-SIZE		87898		SEE TABLE		GENERAL MARKET		SHEET NUMBER	
												9 OF 21	

10		9		8		7		6		5		4		3		2		1	
PACKAGING OPTION PART NO.														CAP (SEE SHEET-16)					
TRAY WITHOUT CAP	TRAY WITH CAP	TUBE WITHOUT CAP	TUBE WITH CAP	TAPE & REEL WITHOUT CAP	TAPE & REEL WITH CAP	CKT SIZE	VOID POSITION	PLATING TYPE	DIMENSION										
									A	B	G	F	M						
-----	-----	87898-2521	87898-2531	-----	-----	25	----	1	63.50	60.96	10.81	9.65	5.84	1					
-----	-----	87898-2522	87898-2532	-----	-----	25	----	2	63.50	60.96	10.81	9.65	5.84	1					
-----	-----	87898-2524	87898-2534	-----	-----	25	----	4	63.50	60.96	10.81	9.65	5.84	1					
-----	-----	87898-2525	87898-2535	-----	-----	25	----	5	63.50	60.96	10.81	9.65	5.84	1					
-----	-----	87898-2526	87898-2536	-----	-----	25	----	6	63.50	60.96	10.81	9.65	5.84	1					
-----	-----	87898-2621	87898-2631	-----	-----	26	----	1	66.04	63.50	10.81	9.65	5.84	1					
-----	-----	87898-2622	87898-2632	-----	-----	26	----	2	66.04	63.50	10.81	9.65	5.84	1					
-----	-----	87898-2624	87898-2634	-----	-----	26	----	4	66.04	63.50	10.81	9.65	5.84	1					
-----	-----	87898-2625	87898-2635	-----	-----	26	----	5	66.04	63.50	10.81	9.65	5.84	1					
-----	-----	87898-2626	87898-2636	-----	-----	26	----	6	66.04	63.50	10.81	9.65	5.84	1					
-----	-----	87898-2627	87898-2637	-----	-----	26	----	6	66.04	63.50	10.81	9.65	5.84	1					
-----	-----	87898-2721	87898-2731	-----	-----	27	----	1	68.58	66.04	10.81	9.65	5.84	1					
-----	-----	87898-2722	87898-2732	-----	-----	27	----	2	68.58	66.04	10.81	9.65	5.84	1					
-----	-----	87898-2724	87898-2734	-----	-----	27	----	4	68.58	66.04	10.81	9.65	5.84	1					
-----	-----	87898-2725	87898-2735	-----	-----	27	----	5	68.58	66.04	10.81	9.65	5.84	1					
-----	-----	87898-2726	87898-2736	-----	-----	27	----	6	68.58	66.04	10.81	9.65	5.84	1					

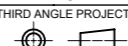
THIS DRAWING CONTAINS INFORMATION THAT IS PROPRIETARY TO MOLEX ELECTRONIC TECHNOLOGIES, LLC AND SHOULD NOT BE USED WITHOUT WRITTEN PERMISSION															
DIMENSION UNITS		SCALE		CURRENT REV DESC:											
mm		NTS													
GENERAL TOLERANCES (UNLESS SPECIFIED)				EC NO: 745488 DRWN: SUAIFR CHK'D: SUAIFR APPR: MRAMAKRISHNA INITIAL REVISION: DRWN: GGUNAGI APPR: ISHWARG						CUSTOM HEADER 2.54MM PITCH SINGLE ROW SINGLE WAFER SMT HEADER PRODUCT CUSTOMER DRAWING					
		MM												INCH	
4 PLACES	±		±												
3 PLACES	±		±												
2 PLACES	±	0.2	±												
1 PLACE	±		±												
0 PLACES	±		±												
ANGULAR TOL		± 3.0°								DOCUMENT NUMBER <b>SD-87898-001</b>					
DRAFT WHERE APPLICABLE MUST REMAIN WITHIN DIMENSIONS				THIRD ANGLE PROJECTION		DRAWING		SERIES		MATERIAL NUMBER		CUSTOMER		SHEET NUMBER	
						A3-SIZE		87898		SEE TABLE		GENERAL MARKET		10 OF 21	

DOCUMENT STATUS	P1	RELEASE DATE	2023/04/10	07:46:21
-----------------	----	--------------	------------	----------

FORMAT: Mel-lega-master-ib-prod-A3  
 REVISION: E  
 DATE: 2023/01/14

PACKAGING OPTION PART NO.						CKT SIZE	VOID POSITION	PLATING TYPE	DIMENSION					CAP (SEE SHEET-16)
TRAY WITHOUT CAP	TRAY WITH CAP	TUBE WITHOUT CAP	TUBE WITH CAP	TAPE & REEL WITHOUT CAP	TAPE & REEL WITH CAP				A	B	G	F	M	
-----	-----	87898-2821	87898-2831	-----	-----	28	----	1	71.12	68.58	10.81	9.65	5.84	1
-----	-----	87898-2822	87898-2832	-----	-----	28	----	2	71.12	68.58	10.81	9.65	5.84	1
-----	-----	87898-2824	87898-2834	-----	-----	28	----	4	71.12	68.58	10.81	9.65	5.84	1
-----	-----	87898-2825	87898-2835	-----	-----	28	----	5	71.12	68.58	10.81	9.65	5.84	1
-----	-----	87898-2826	87898-2836	-----	-----	28	----	6	71.12	68.58	10.81	9.65	5.84	1
-----	-----	87898-2921	87898-2931	-----	-----	29	----	1	73.66	71.12	10.81	9.65	5.84	1
-----	-----	87898-2922	87898-2932	-----	-----	29	----	2	73.66	71.12	10.81	9.65	5.84	1
-----	-----	87898-2924	87898-2934	-----	-----	29	----	4	73.66	71.12	10.81	9.65	5.84	1
-----	-----	87898-2925	87898-2935	-----	-----	29	----	5	73.66	71.12	10.81	9.65	5.84	1
-----	-----	87898-2926	87898-2936	-----	-----	29	----	6	73.66	71.12	10.81	9.65	5.84	1
-----	-----	87898-3021	87898-3031	-----	-----	30	----	1	76.20	73.66	10.81	9.65	5.84	1
-----	-----	87898-3022	87898-3032	-----	-----	30	----	2	76.20	73.66	10.81	9.65	5.84	1
-----	-----	87898-3024	87898-3034	-----	-----	30	----	4	76.20	73.66	10.81	9.65	5.84	1
-----	-----	87898-3025	87898-3035	-----	-----	30	----	5	76.20	73.66	10.81	9.65	5.84	1
-----	-----	87898-3026	87898-3036	-----	-----	30	----	6	76.20	73.66	10.81	9.65	5.84	1



THIS DRAWING CONTAINS INFORMATION THAT IS PROPRIETARY TO MOLEX ELECTRONIC TECHNOLOGIES, LLC AND SHOULD NOT BE USED WITHOUT WRITTEN PERMISSION															
DIMENSION UNITS		SCALE		CURRENT REV DESC:											
mm		NTS													
GENERAL TOLERANCES (UNLESS SPECIFIED)				EC NO: 745488 DRWN: SUAIFR CHK'D: SUAIFR APPR: MRAMAKRISHNA INITIAL REVISION: DRWN: GGUNAGI APPR: ISHWARG						CUSTOM HEADER 2.54MM PITCH SINGLE ROW SINGLE WAFER SMT HEADER PRODUCT CUSTOMER DRAWING					
		MM INCH													
4 PLACES	±		±												
3 PLACES	±		±												
2 PLACES	±	0.2	±												
1 PLACE	±		±												
0 PLACES	±		±												
ANGULAR TOL ± 3.0°				DOCUMENT NUMBER: SD-87898-001 DOC TYPE: PSD DOC PART: 000 REVISION: B26											
DRAFT WHERE APPLICABLE MUST REMAIN WITHIN DIMENSIONS				THIRD ANGLE PROJECTION		DRAWING		SERIES		MATERIAL NUMBER		CUSTOMER		SHEET NUMBER	
						A3-SIZE		87898		SEE TABLE		GENERAL MARKET		11 OF 21	

DOCUMENT STATUS	P1	RELEASE DATE	2023/04/10	07:46:21
-----------------	----	--------------	------------	----------

10		9		8		7		6		5		4		3		2		1	
PACKAGING OPTION PART NO.														CAP (SEE SHEET-16)					
TRAY WITHOUT CAP	TRAY WITH CAP	TUBE WITHOUT CAP	TUBE WITH CAP	TAPE & REEL WITHOUT CAP	TAPE & REEL WITH CAP	CKT SIZE	VOID POSITION	PLATING TYPE	A	B	G	F	M						
-----	-----	87898-3121	87898-3131	-----	-----	31	-----	1	78.74	76.20	10.81	9.65	5.84	1					
-----	-----	87898-3122	87898-3132	-----	-----	31	-----	2	78.74	76.20	10.81	9.65	5.84	1					
-----	-----	87898-3124	87898-3134	-----	-----	31	-----	4	78.74	76.20	10.81	9.65	5.84	1					
-----	-----	87898-3125	87898-3135	-----	-----	31	-----	5	78.74	76.20	10.81	9.65	5.84	1					
-----	-----	87898-3126	87898-3136	-----	-----	31	-----	6	78.74	76.20	10.81	9.65	5.84	1					
-----	-----	87898-3221	87898-3231	-----	-----	32	-----	1	81.28	78.74	10.81	9.65	5.84	1					
-----	-----	87898-3222	87898-3232	-----	-----	32	-----	2	81.28	78.74	10.81	9.65	5.84	1					
-----	-----	87898-3224	87898-3234	-----	-----	32	-----	4	81.28	78.74	10.81	9.65	5.84	1					
-----	-----	87898-3225	87898-3235	-----	-----	32	-----	5	81.28	78.74	10.81	9.65	5.84	1					
-----	-----	87898-3226	87898-3236	-----	-----	32	-----	6	81.28	78.74	10.81	9.65	5.84	1					
-----	-----	87898-3227	87898-3237	-----	-----	32	-----	6	81.28	78.74	10.81	9.65	5.84	1					
-----	-----	87898-3321	87898-3331	-----	-----	33	-----	1	83.82	81.28	10.81	9.65	5.84	1					
-----	-----	87898-3322	87898-3332	-----	-----	33	-----	2	83.82	81.28	10.81	9.65	5.84	1					
-----	-----	87898-3324	87898-3334	-----	-----	33	-----	4	83.82	81.28	10.81	9.65	5.84	1					
-----	-----	87898-3325	87898-3335	-----	-----	33	-----	5	83.82	81.28	10.81	9.65	5.84	1					
-----	-----	87898-3326	87898-3336	-----	-----	33	-----	6	83.82	81.28	10.81	9.65	5.84	1					

THIS DRAWING CONTAINS INFORMATION THAT IS PROPRIETARY TO MOLEX ELECTRONIC TECHNOLOGIES, LLC AND SHOULD NOT BE USED WITHOUT WRITTEN PERMISSION															
DIMENSION UNITS		SCALE		CURRENT REV DESC:											
mm		NTS		<p style="text-align: center;"><b>molex</b></p> <p style="text-align: center;">CUSTOM HEADER 2.54MM PITCH SINGLE ROW SINGLE WAFER SMT HEADER</p> <p style="text-align: center;">PRODUCT CUSTOMER DRAWING</p>											
GENERAL TOLERANCES (UNLESS SPECIFIED)															
		MM												INCH	
4 PLACES	±		±												
3 PLACES	±		±												
2 PLACES	±	0.2	±												
1 PLACE	±		±												
0 PLACES	±		±												
ANGULAR TOL		± 3.0°		EC NO: 745488 DRWN: SUAIFR APPR: MRAMAKRISHNA INITIAL REVISION: DRWN: GGUNAGI APPR: ISHWARG											
DRAFT WHERE APPLICABLE MUST REMAIN WITHIN DIMENSIONS		THIRD ANGLE PROJECTION		DRAWING		SERIES		MATERIAL NUMBER		CUSTOMER		SHEET NUMBER			
				A3-SIZE		87898		SEE TABLE		GENERAL MARKET		12 OF 21			

DOCUMENT STATUS	P1	RELEASE DATE	2023/04/10	07:46:21
-----------------	----	--------------	------------	----------

PACKAGING OPTION PART NO.										DIMENSION					CAP (SEE SHEET-16)
TRAY WITHOUT CAP	TRAY WITH CAP	TUBE WITHOUT CAP	TUBE WITH CAP	TAPE & REEL WITHOUT CAP	TAPE & REEL WITH CAP	CKT SIZE	VOID POSITION	PLATING TYPE	A	B	G	F	M		
-----	-----	87898-3421	87898-3431	-----	-----	34	-----	1	86.36	83.82	10.81	9.65	5.84	1	
-----	-----	87898-3422	87898-3432	-----	-----	34	-----	2	86.36	83.82	10.81	9.65	5.84	1	
-----	-----	87898-3424	87898-3434	-----	-----	34	-----	4	86.36	83.82	10.81	9.65	5.84	1	
-----	-----	87898-3425	87898-3435	-----	-----	34	-----	5	86.36	83.82	10.81	9.65	5.84	1	
-----	-----	87898-3426	87898-3436	-----	-----	34	-----	6	86.36	83.82	10.81	9.65	5.84	1	
-----	-----	87898-3521	87898-3531	-----	-----	35	-----	1	88.90	86.36	10.81	9.65	5.84	1	
-----	-----	87898-3522	87898-3532	-----	-----	35	-----	2	88.90	86.36	10.81	9.65	5.84	1	
-----	-----	87898-3524	87898-3534	-----	-----	35	-----	4	88.90	86.36	10.81	9.65	5.84	1	
-----	-----	87898-3525	87898-3535	-----	-----	35	-----	5	88.90	86.36	10.81	9.65	5.84	1	
-----	-----	87898-3526	87898-3536	-----	-----	35	-----	6	88.90	86.36	10.81	9.65	5.84	1	
-----	-----	87898-3621	87898-3631	-----	-----	36	-----	1	91.44	88.90	10.81	9.65	5.84	1	
-----	-----	87898-3622	87898-3632	-----	-----	36	-----	2	91.44	88.90	10.81	9.65	5.84	1	
-----	-----	87898-3624	87898-3634	-----	-----	36	-----	4	91.44	88.90	10.81	9.65	5.84	1	
-----	-----	87898-3625	87898-3635	-----	-----	36	-----	5	91.44	88.90	10.81	9.65	5.84	1	
-----	-----	87898-3626	87898-3636	-----	-----	36	-----	6	91.44	88.90	10.81	9.65	5.84	1	

THIS DRAWING CONTAINS INFORMATION THAT IS PROPRIETARY TO MOLEX ELECTRONIC TECHNOLOGIES, LLC AND SHOULD NOT BE USED WITHOUT WRITTEN PERMISSION										CURRENT REV DESC:					 CUSTOM HEADER 2.54MM PITCH SINGLE ROW SINGLE WAFER SMT HEADER PRODUCT CUSTOMER DRAWING																				
DIMENSION UNITS		SCALE		GENERAL TOLERANCES (UNLESS SPECIFIED)		MM		INCH		EC NO: 745488		DRWN: SUAIFR		2023/02/15						CHK'D: SUAIFR		2023/04/10		APPR: MRAMAKRISHNA		2023/04/10									
4 PLACES		±		±		±		±		INITIAL REVISION:		DRWN: GGUNAGI		2016/11/09		APPR: ISHWARG		2016/12/06		DOCUMENT NUMBER		SD-87898-001		DOC TYPE		PSD		DOC PART		000		REVISION		B26	
1 PLACE		±		±		±		±		DRAFT WHERE APPLICABLE MUST REMAIN WITHIN DIMENSIONS		THIRD ANGLE PROJECTION		DRAWING		SERIES		MATERIAL NUMBER		CUSTOMER		SHEET NUMBER		A3-SIZE		87898		SEE TABLE		GENERAL MARKET		13 OF 21			

DOCUMENT STATUS	P1	RELEASE DATE	2023/04/10	07:46:21
-----------------	----	--------------	------------	----------

PACKAGING OPTION PART NO.						CKT SIZE	VOID POSITION	PLATING TYPE	DIMENSION					CAP (SEE SHEET-16)
TRAY WITHOUT CAP	TRAY WITH CAP	TUBE WITHOUT CAP	TUBE WITH CAP	TAPE & REEL WITHOUT CAP	TAPE & REEL WITH CAP				A	B	G	F	M	
-----	-----	87898-3721	87898-3731	-----	-----	37	----	1	93.98	91.44	10.81	9.65	5.84	1
-----	-----	87898-3722	87898-3732	-----	-----	37	----	2	93.98	91.44	10.81	9.65	5.84	1
-----	-----	87898-3724	87898-3734	-----	-----	37	----	4	93.98	91.44	10.81	9.65	5.84	1
-----	-----	87898-3725	87898-3735	-----	-----	37	----	5	93.98	91.44	10.81	9.65	5.84	1
-----	-----	87898-3726	87898-3736	-----	-----	37	----	6	93.98	91.44	10.81	9.65	5.84	1
-----	-----	87898-3821	87898-3831	-----	-----	38	----	1	96.52	93.98	10.81	9.65	5.84	1
-----	-----	87898-3822	87898-3832	-----	-----	38	----	2	96.52	93.98	10.81	9.65	5.84	1
-----	-----	87898-3824	87898-3834	-----	-----	38	----	4	96.52	93.98	10.81	9.65	5.84	1
-----	-----	87898-3825	87898-3835	-----	-----	38	----	5	96.52	93.98	10.81	9.65	5.84	1
-----	-----	87898-3826	87898-3836	-----	-----	38	----	6	96.52	93.98	10.81	9.65	5.84	1
-----	-----	87898-3921	87898-3931	-----	-----	39	----	1	99.06	96.52	10.81	9.65	5.84	1
-----	-----	87898-3922	87898-3932	-----	-----	39	----	2	99.06	96.52	10.81	9.65	5.84	1
-----	-----	87898-3924	87898-3934	-----	-----	39	----	4	99.06	96.52	10.81	9.65	5.84	1
-----	-----	87898-3925	87898-3935	-----	-----	39	----	5	99.06	96.52	10.81	9.65	5.84	1
-----	-----	87898-3926	87898-3936	-----	-----	39	----	6	99.06	96.52	10.81	9.65	5.84	1

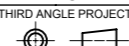
THIS DRAWING CONTAINS INFORMATION THAT IS PROPRIETARY TO MOLEX ELECTRONIC TECHNOLOGIES, LLC AND SHOULD NOT BE USED WITHOUT WRITTEN PERMISSION													
DIMENSION UNITS		SCALE		CURRENT REV DESC:									
mm		NTS											
GENERAL TOLERANCES (UNLESS SPECIFIED)				EC NO: 745488 DRWN: SUAIFR CHK'D: SUAIFR APPR: MRAMAKRISHNA INITIAL REVISION: DRWN: GGUNAGI APPR: ISHWARG				CUSTOM HEADER 2.54MM PITCH SINGLE ROW SINGLE WAFER SMT HEADER					
										PRODUCT CUSTOMER DRAWING			
4 PLACES		±						2023/02/15				DOCUMENT NUMBER <b>SD-87898-001</b>	
3 PLACES		±						2023/04/10		DOC TYPE			
2 PLACES		± 0.2						2023/04/10		DOC PART			
1 PLACE		±				REVISION							
0 PLACES		±				000							
ANGULAR TOL ± 3.0°				2016/11/09		B26							
				2016/12/06									
DRAFT WHERE APPLICABLE MUST REMAIN WITHIN DIMENSIONS				THIRD ANGLE PROJECTION		DRAWING		SERIES					
						A3-SIZE		87898					
				MATERIAL NUMBER		CUSTOMER		SHEET NUMBER					
				SEE TABLE		GENERAL MARKET		14 OF 21					

DOCUMENT STATUS	P1	RELEASE DATE	2023/04/10	07:46:21
-----------------	----	--------------	------------	----------

PACKAGING OPTION PART NO.						CKT SIZE	VOID POSITION	PLATING TYPE	DIMENSION					CAP (SEE SHEET-16)
TRAY WITHOUT CAP	TRAY WITH CAP	TUBE WITHOUT CAP	TUBE WITH CAP	TAPE & REEL WITHOUT CAP	TAPE & REEL WITH CAP				A	B	G	F	M	
-----	-----	87898-4021	87898-4031	-----	-----	40	-----	1	101.60	99.06	10.81	9.65	5.84	1
-----	-----	87898-4022	87898-4032	-----	-----	40	-----	2	101.60	99.06	10.81	9.65	5.84	1
-----	-----	87898-4024	87898-4034	-----	-----	40	-----	4	101.60	99.06	10.81	9.65	5.84	1
-----	-----	87898-4025	87898-4035	-----	-----	40	-----	5	101.60	99.06	10.81	9.65	5.84	1
-----	-----	87898-4026	87898-4036	-----	-----	40	-----	6	101.60	99.06	10.81	9.65	5.84	1



THIS DRAWING CONTAINS INFORMATION THAT IS PROPRIETARY TO MOLEX ELECTRONIC TECHNOLOGIES, LLC AND SHOULD NOT BE USED WITHOUT WRITTEN PERMISSION																					
DIMENSION UNITS		SCALE		CURRENT REV DESC:																	
mm		NTS																			
GENERAL TOLERANCES (UNLESS SPECIFIED)				EC NO: 745488 DRWN: SUAIFR 2023/02/15 CHK'D: SUAIFR 2023/04/10 APPR: MRAMAKRISHNA 2023/04/10 INITIAL REVISION: DRWN: GGUNAGI 2016/11/09 APPR: ISHWARG 2016/12/06						CUSTOM HEADER 2.54MM PITCH SINGLE ROW SINGLE WAFER SMT HEADER											
														PRODUCT CUSTOMER DRAWING							
										DOCUMENT NUMBER		DOC TYPE						DOC PART		REVISION	
4 PLACES ±		±								SD-87898-001		PSD						000		B26	
3 PLACES ±		±																			
2 PLACES ±		0.2 ±																			
1 PLACE ±		±																			
0 PLACES ±		±																			
ANGULAR TOL ± 3.0°				THIRD ANGLE PROJECTION		DRAWING		SERIES		MATERIAL NUMBER		CUSTOMER		SHEET NUMBER							
DRAFT WHERE APPLICABLE MUST REMAIN WITHIN DIMENSIONS						A3-SIZE		87898		SEE TABLE		GENERAL MARKET		15 OF 21							

DOCUMENT STATUS	P1	RELEASE DATE	2023/04/10	07:46:21
-----------------	----	--------------	------------	----------

# CAP ORIENTATION (CAP - 1)

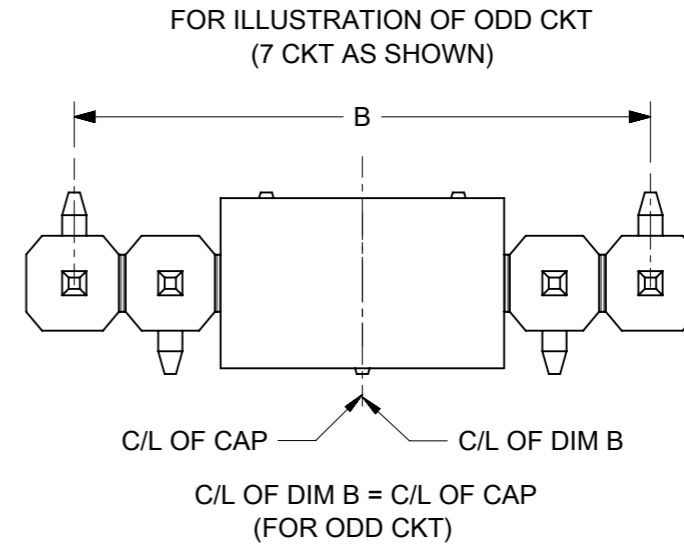

# CAP ORIENTATION (CAP - 2)

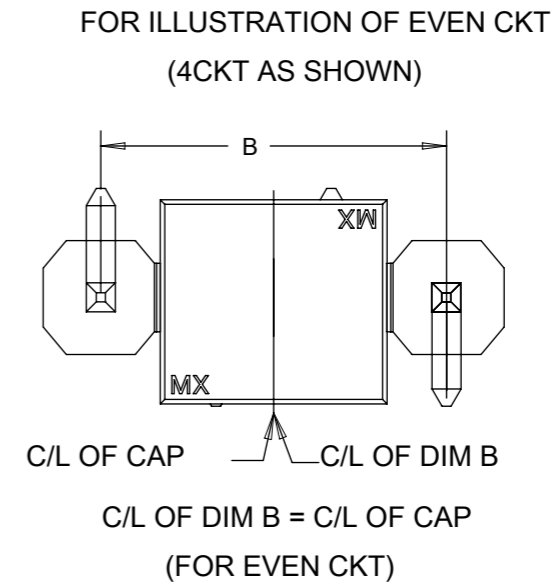
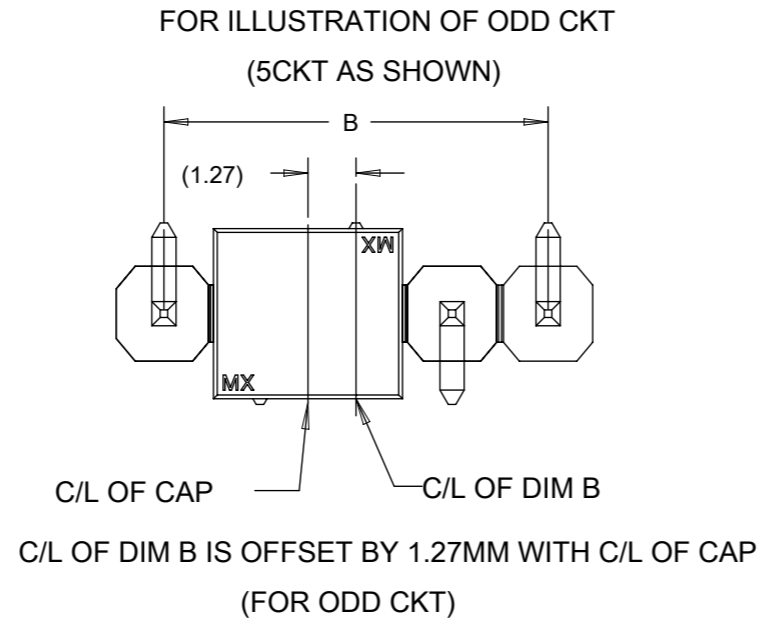

# PART ORIENTATION IN TUBE



PART WITHOUT CAP

PART WITH CAP

THIS DRAWING CONTAINS INFORMATION THAT IS PROPRIETARY TO MOLEX ELECTRONIC TECHNOLOGIES, LLC AND SHOULD NOT BE USED WITHOUT WRITTEN PERMISSION											
DIMENSION UNITS		SCALE		CURRENT REV DESC:							
mm		NTS									
GENERAL TOLERANCES (UNLESS SPECIFIED)				EC NO: 745488		DRWN: SUAIFR		2023/02/15		<b>SD-87898-001</b>	
				CHK'D: SUAIFR		2023/04/10		PSD			
				APPR: MRAMAKRISHNA		2023/04/10		PRODUCT CUSTOMER DRAWING		REVISION	
				INITIAL REVISION:		DRWN: GGUNAGI		2016/11/09		B26	
				APPR: ISHWARG		2016/12/06		DOCUMENT NUMBER		DOC TYPE	
ANGULAR TOL ± 3.0°				DRAFT WHERE APPLICABLE MUST REMAIN WITHIN DIMENSIONS		THIRD ANGLE PROJECTION		DRAWING		SHEET NUMBER	
						A3-SIZE		SERIES		16 OF 21	
						87898		MATERIAL NUMBER		GENERAL MARKET	
						SEE TABLE		CUSTOMER			



EMBOSED CARRIER TYPE 'A'

CKT	DIMENSION				
	Bo	Ao	Ko	F	W
2	8.02	5.20	13.60	11.50	24.00
3	8.02	5.20	13.60	11.50	24.00
4	10.55	5.20	13.60	11.50	24.00

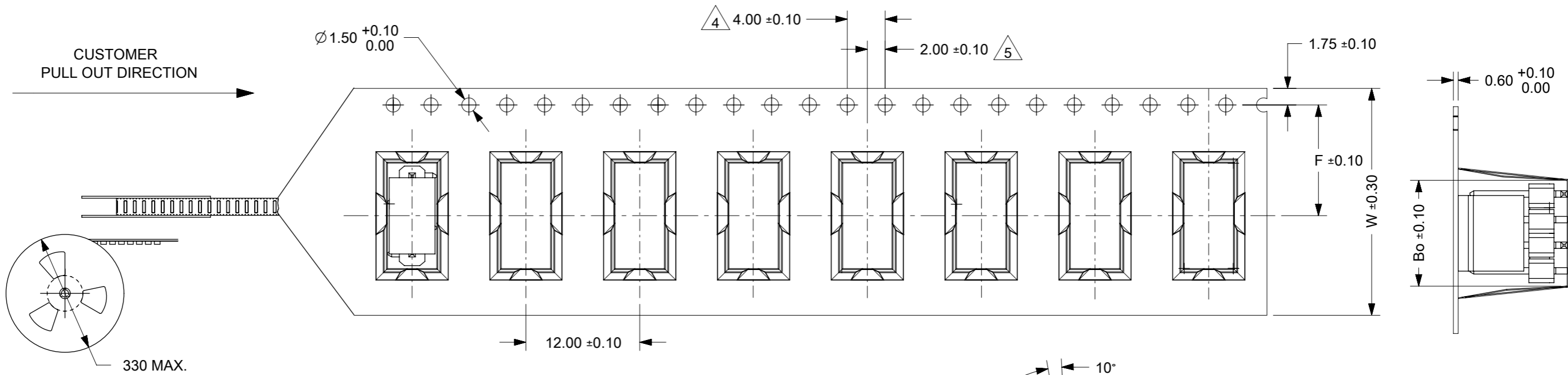

NOTES:  
1. LEADER AND TRAILER TAPE

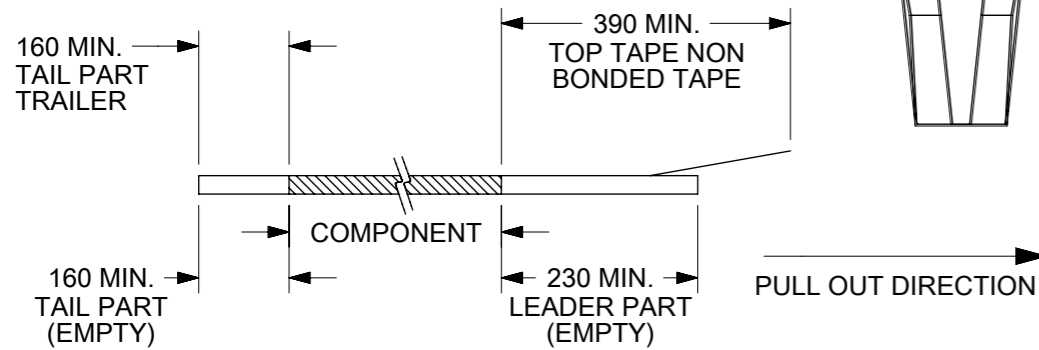

2. PEELING OFF FORCE OF THE TOP TAPE: 20 - 80gf.  
(PEELING DIRECTION AS SHOWN IN FOLLOWING FIGURE)

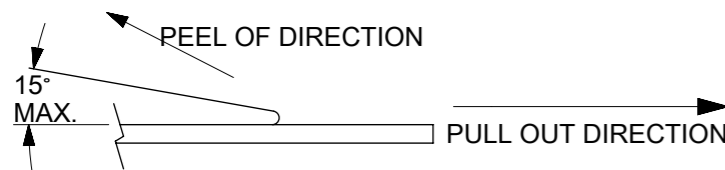

3. MATERIAL: BLACK P.S CONDUCTIVE, BLACK

4. MEASURED FROM CENTRELINE OF SPROCKET HOLE TO CENTRELINE OF SPOCKET

5. CUMULATIVE TOLERANCE OF 10 SPROCKET HOLE IS  $\pm 0.20$ mm

6. AO AND BO ARE MEASURE FROM ABOVE POCKET BASE 0.30mm

7. TAPE AND REEL SPECIFICATION IS AS PER EIA-481.

8. TAPE AND REEL QUANTITY : 440PCS/REEL

9. THE TAPE IS TREATED FOR ANTI-STATIC.

10. ALL RADIUS ARE 0.30MM UNLESS SPECIFY

11. SURFACE RESISTIVITY  $10^3$  TO  $10^6$  OHMS.

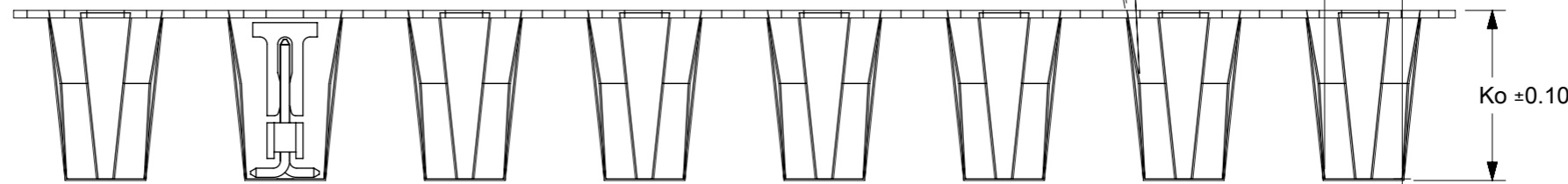

THIS DRAWING CONTAINS INFORMATION THAT IS PROPRIETARY TO MOLEX ELECTRONIC TECHNOLOGIES, LLC AND SHOULD NOT BE USED WITHOUT WRITTEN PERMISSION		CURRENT REV DESC:		<b>molex</b>	
DIMENSION UNITS	SCALE	EC NO: 745488			
mm	NTS	DRWN: SUAIFR 2023/02/15		2.54MM PITCH SINGLE ROW SINGLE WAFER SMT HEADER	
GENERAL TOLERANCES (UNLESS SPECIFIED)		CHK'D: SUAIFR 2023/04/10		PRODUCT CUSTOMER DRAWING	
		APPR: MRAMAKRISHNA 2023/04/10		DOCUMENT NUMBER	
		INITIAL REVISION:		SD-87898-001	
		DRWN: GGUNAGI 2016/11/09		DOC TYPE	
		APPR: ISHWARG 2016/12/06		PSD	
ANGULAR TOL $\pm 3.0^\circ$		SERIES		DOC PART	
		A3-SIZE		000	
DRAFT WHERE APPLICABLE MUST REMAIN WITHIN DIMENSIONS		THIRD ANGLE PROJECTION		REVISION	
		87898		B26	
		MATERIAL NUMBER		SHEET NUMBER	
		SEE TABLE		17 OF 21	
		CUSTOMER			
		GENERAL MARKET			

CKT	DIMENSION				
	Bo	Ao	Ko	F	W
5	13.10	5.20	11.30	11.50	24.00

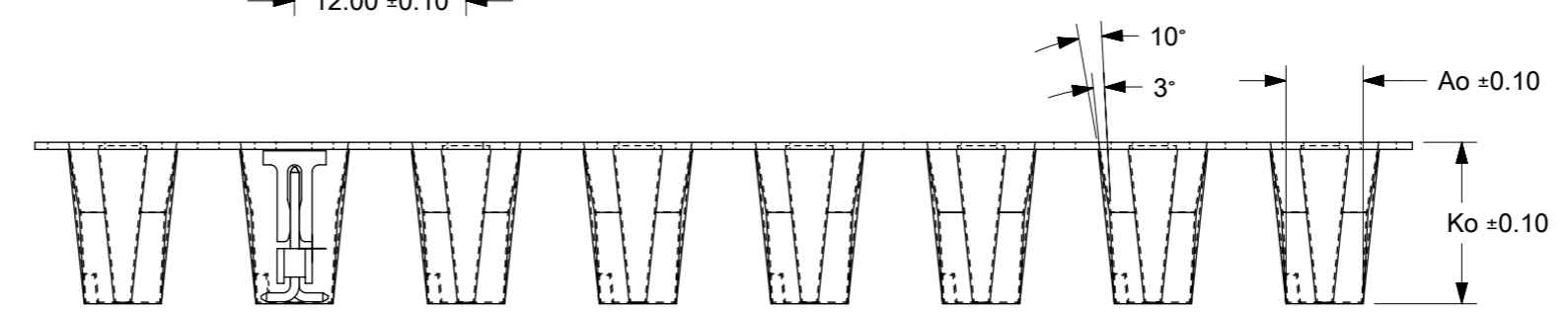
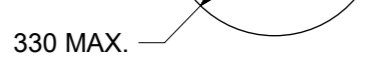

NOTES:  
1. LEADER AND TRAILER TAPE

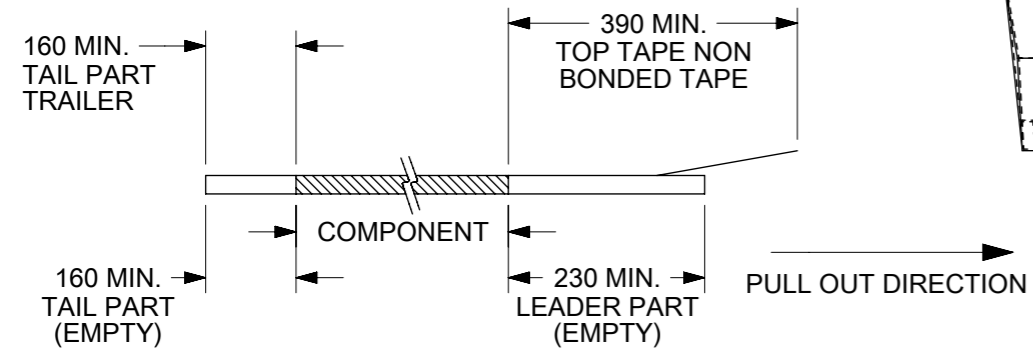

2. PEELING OFF FORCE OF THE TOP TAPE: 20 - 80gf.  
(PEELING DIRECTION AS SHOWN IN FOLLOWING FIGURE)

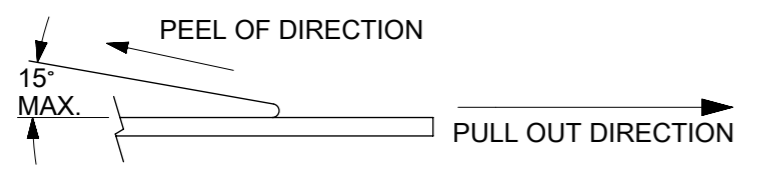

- 3. MATERIAL: BLACK P.S CONDUCTIVE, BLACK
- 4. MEASURED FROM CENTRELINE OF SPROCKET HOLE TO CENTRELINE OF SPOCKET
- 5. CUMULATIVE TOLERANCE OF 10 SPROCKET HOLE IS ±0.20mm
- 6. A0 AND B0 ARE MEASURE FROM ABOVE POCKET BASE 0.30mm
- 7. TAPE AND REEL SPECIFICATION IS AS PER EIA-481.
- 8. TAPE AND REEL QUANTITY : 440PCS/REEL
- 9. THE TAPE IS TREATED FOR ANTI-STATIC.
- 10. ALL RADIUS ARE 0.30MM UNLESS SPECIFY
- 11. SURFACE RESISTIVITY 10<sup>3</sup> TO 10 OHMS.

THIS DRAWING CONTAINS INFORMATION THAT IS PROPRIETARY TO MOLEX ELECTRONIC TECHNOLOGIES, LLC AND SHOULD NOT BE USED WITHOUT WRITTEN PERMISSION		CURRENT REV DESC:		<b>molex</b>	
DIMENSION UNITS: mm		SCALE: NTS			
GENERAL TOLERANCES (UNLESS SPECIFIED)				CUSTOM HEADER 2.54MM PITCH SINGLE ROW SINGLE WAFER SMT HEADER	
				PRODUCT CUSTOMER DRAWING	
4 PLACES ±				DOCUMENT NUMBER	
3 PLACES ±				SD-87898-001	
2 PLACES ± 0.2				DOC TYPE	
1 PLACE ±				PSD	
0 PLACES ±				DOC PART	
ANGULAR TOL ± 3.0°				000	
DRAFT WHERE APPLICABLE MUST REMAIN WITHIN DIMENSIONS				REVISION	
THIRD ANGLE PROJECTION				B26	
DRAWING: A3-SIZE				SERIES: 87898	
MATERIAL NUMBER: SEE TABLE				CUSTOMER: GENERAL MARKET	
SHEET NUMBER: 18 OF 21					

10  
9  
8  
7  
6  
5  
4  
3  
2  
1

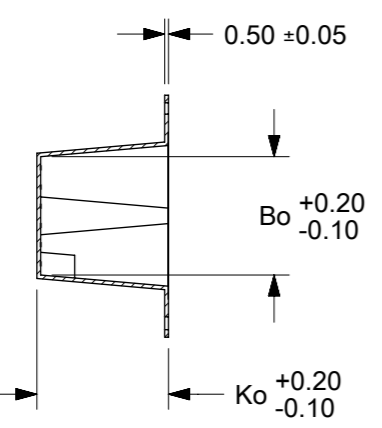

CKT	DIMENSION							TYPE	QTY/ REEL
	M	Bo	So	Ao	Ko	F	W		
6	11.50	15.65	28.40	5.20	16.90	14.20	32.00	A	150
6	5.84	15.65	28.40	5.20	11.30	14.20	32.00	B	440
8		20.70	40.40	5.20	11.30	20.20	44.00		
10		25.80	40.40	5.20	11.30	20.20	44.00		
12		30.90	52.40	5.20	11.30	26.20	56.00		
14		35.95	52.40	5.20	11.30	26.20	56.00		
16		41.05	52.40	5.20	11.30	26.20	56.00		
18		46.20	68.40	5.20	11.30	34.20	72.00		
20		51.20	68.40	5.20	11.30	34.20	72.00		

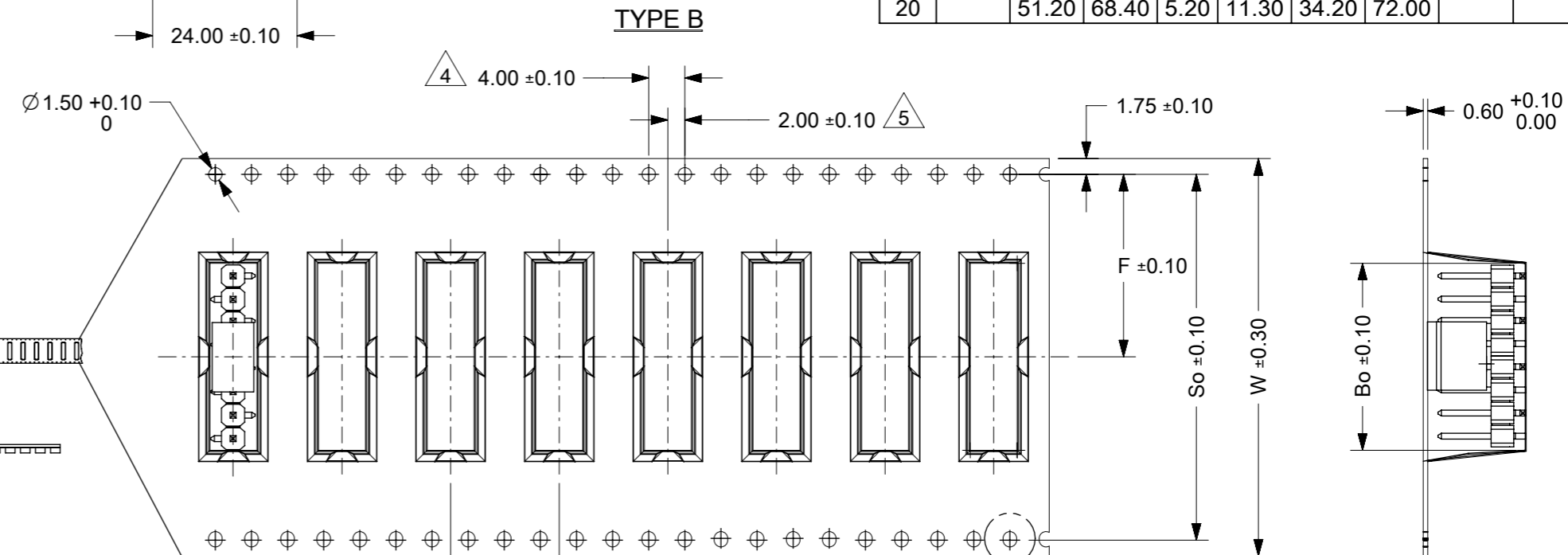
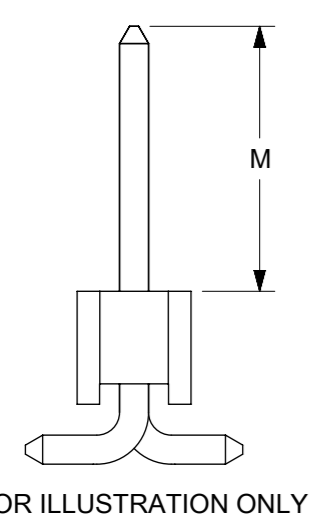

NOTES:  
1. LEADER AND TRAILER TAPE

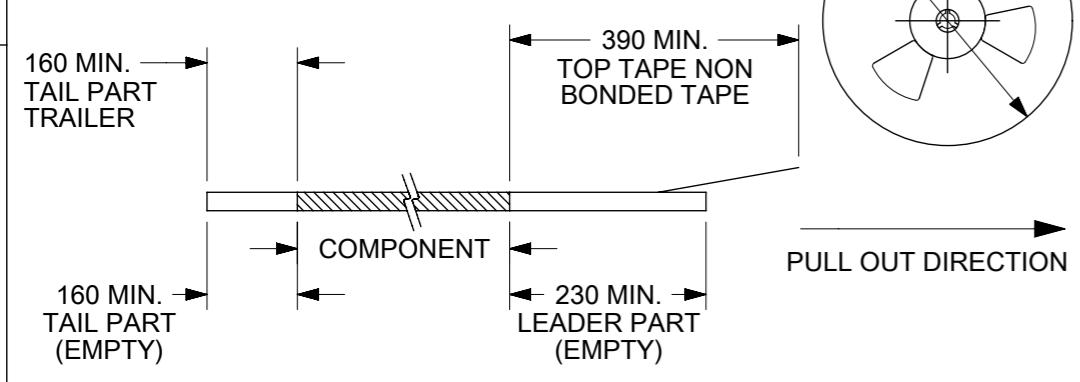

2. PEELING OFF FORCE OF THE TOP TAPE: 20 - 80gf.  
(PEELING DIRECTION AS SHOWN IN FOLLOWING FIGURE)

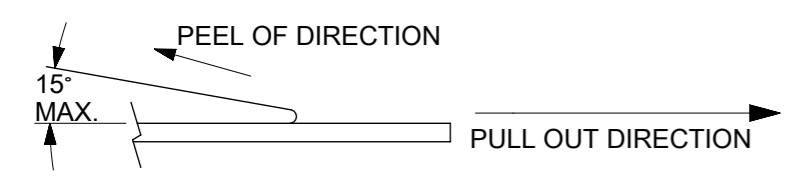

- 3. MATERIAL: BLACK P.S CONDUCTIVE, BLACK
- 4. MEASURED FROM CENTRELINE OF SPROCKET HOLE TO CENTRELINE OF SPOCKET
- 5. CUMULATIVE TOLERANCE OF 10 SPROCKET HOLE IS ±0.20mm
- 6. A0 AND B0 ARE MEASURE FROM ABOVE POCKET BASE 0.30mm
- 7. TAPE AND REEL SPECIFICATION IS AS PER EIA-481.
- 8. TAPE AND REEL QUANTITY : SEE TABLE
- 9. THE TAPE IS TREATED FOR ANTI-STATIC.
- 10. ALL RADIUS ARE 0.30MM UNLESS SPECIFY
- 11. SURFACE RESISTIVITY 10<sup>3</sup> TO 10 OHMS.

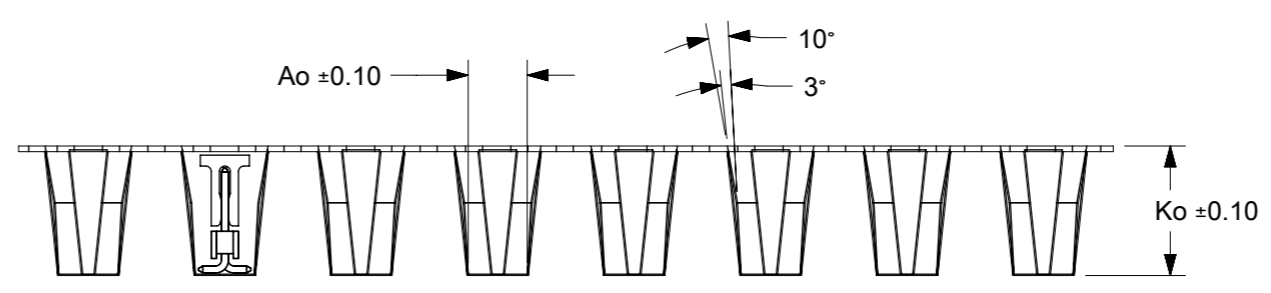

THIS DRAWING CONTAINS INFORMATION THAT IS PROPRIETARY TO MOLEX ELECTRONIC TECHNOLOGIES, LLC AND SHOULD NOT BE USED WITHOUT WRITTEN PERMISSION

DIMENSION UNITS	SCALE	CURRENT REV DESC:	
mm	NTS		
GENERAL TOLERANCES (UNLESS SPECIFIED)			
	MM	INCH	
4 PLACES	±	±	
3 PLACES	±	±	
2 PLACES	±	0.2	±
1 PLACE	±	±	
0 PLACES	±	±	
ANGULAR TOL	±	3.0°	
DRAFT WHERE APPLICABLE MUST REMAIN WITHIN DIMENSIONS		THIRD ANGLE PROJECTION	DRAWING SERIES
			A3-SIZE 87898

molex		
CUSTOM HEADER 2.54MM PITCH SINGLE ROW SINGLE WAFER SMT HEADER		
PRODUCT CUSTOMER DRAWING		
DOCUMENT NUMBER	DOC TYPE	DOC PART
SD-87898-001	PSD	000
REVISION	REVISION	
B26	19 OF 21	

9  
8  
7  
6  
5  
4  
3  
2  
1

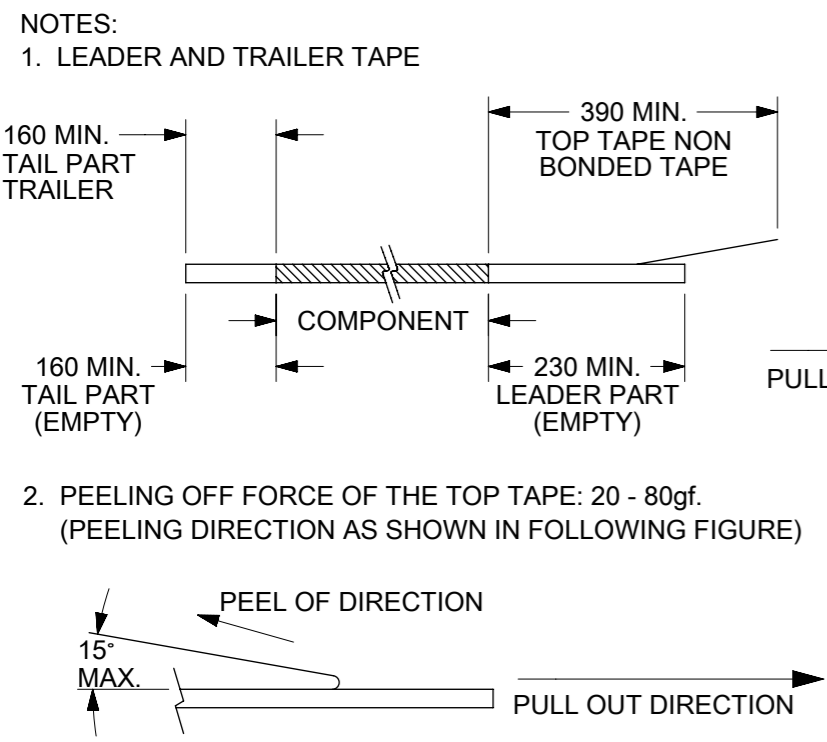

CKT	DIMENSION					
	Bo	So	Ao	Ko	F	W
7	18.20	40.40	5.20	11.30	20.20	44.00
9	23.25	40.40	5.20	11.30	20.20	44.00
11	28.35	40.40	5.20	11.30	20.20	44.00
13	33.40	52.40	5.20	11.30	26.20	56.00
15	38.50	52.40	5.20	11.30	26.20	56.00
17	43.60	68.40	5.20	11.30	34.20	72.00
19	48.70	68.40	5.20	11.30	34.20	72.00
21	53.80	68.40	5.20	11.30	34.20	72.00

THIS DRAWING CONTAINS INFORMATION THAT IS PROPRIETARY TO MOLEX ELECTRONIC TECHNOLOGIES, LLC AND SHOULD NOT BE USED WITHOUT WRITTEN PERMISSION

DIMENSION UNITS	SCALE	CURRENT REV DESC:	
mm	NTS		
GENERAL TOLERANCES (UNLESS SPECIFIED)			
	MM	INCH	
4 PLACES	±	±	
3 PLACES	±	±	
2 PLACES	± 0.2	±	
1 PLACE	±	±	
0 PLACES	±	±	
ANGULAR TOL	± 3.0°		
DRAFT WHERE APPLICABLE MUST REMAIN WITHIN DIMENSIONS		THIRD ANGLE PROJECTION	DRAWING
			A3-SIZE
		SERIES	87898
		MATERIAL NUMBER	SEE TABLE
		CUSTOMER	GENERAL MARKET
		SHEET NUMBER	20 OF 21

EC NO: 745488  
 DRWN: SUIFR 2023/02/15  
 CHK'D: SUIFR 2023/04/10  
 APPR: MRAMAKRISHNA 2023/04/10

INITIAL REVISION:  
 DRWN: GGUNAGI 2016/11/09  
 APPR: ISHWARG 2016/12/06

**molex**  
 CUSTOM HEADER  
 2.54MM PITCH SINGLE ROW SINGLE WAFER SMT HEADER

PRODUCT CUSTOMER DRAWING

DOCUMENT NUMBER: SD-87898-001  
 DOC TYPE: PSD  
 DOC PART: 000  
 REVISION: B26

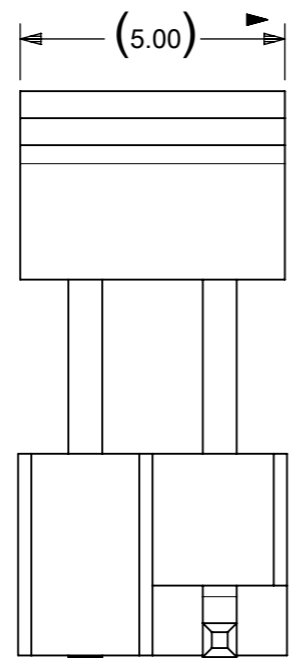
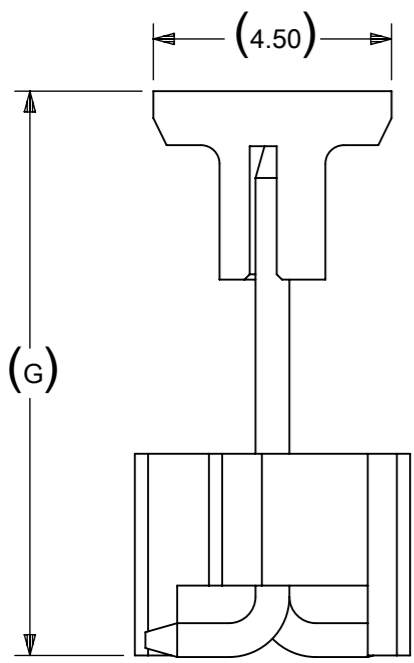
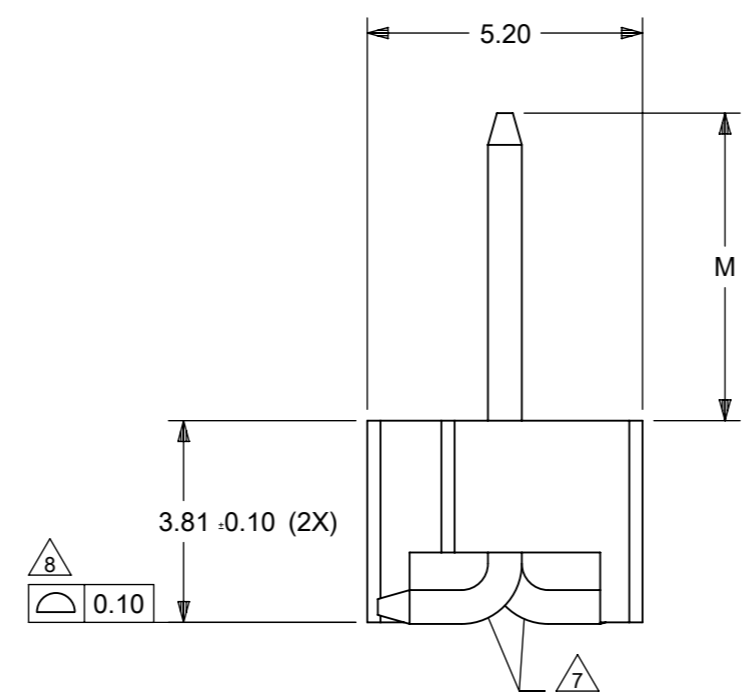
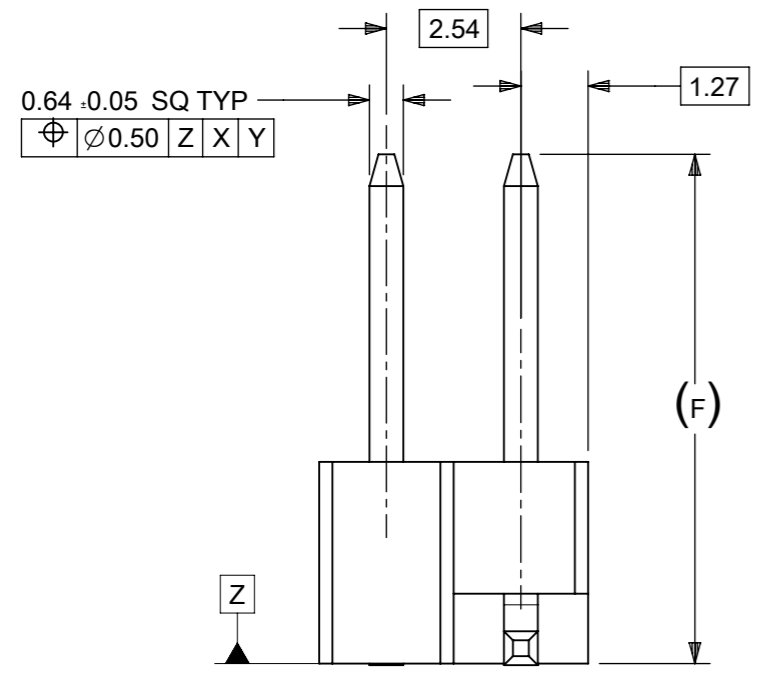
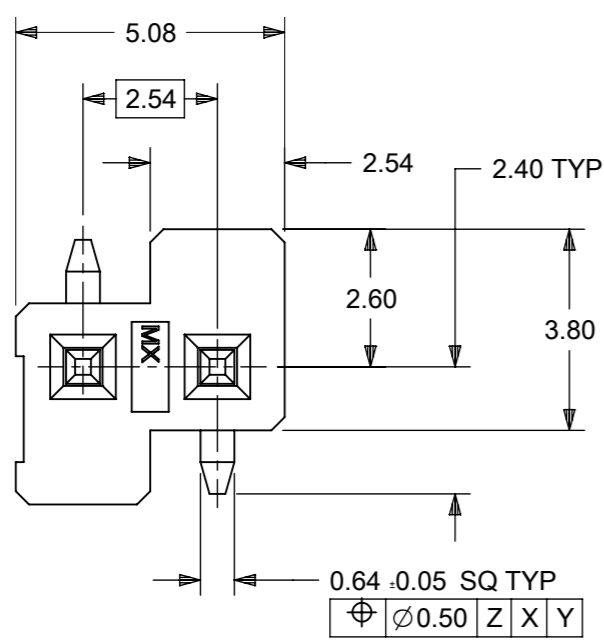

PACKAGING OPTION PART NO.						CKT SIZE	PLATING TYPE	DIMENSION			CAP (SEE SHEET-16)
TRAY WITHOUT CAP	TRAY WITH CAP	TUBE WITHOUT CAP	TUBE WITH CAP	TAPE & REEL WITHOUT CAP	TAPE & REEL WITH CAP			G	F	M	
-----	-----	-----	-----	-----	87898-0218	2	4	10.69	9.65	5.84	2
-----	-----	-----	-----	-----	87898-0219	2	6	10.69	9.65	5.84	2
-----	-----	-----	87898-0220	-----	-----	2	6	10.64	9.60	5.84	-
-----	-----	-----	-----	-----	87898-0221	2	6	24.53	23.49	19.73	-

ONLY APPLICABLE TO 2CKT SIZE

- NOTES:
- MATERIAL:
    - HSG: LCP, GLASS-FILLED, UL94V-0, COLOR: BLACK
    - CAP: NYLON, GLASS-FILLED, UL94V-0, COLOR: BLACK
    - PIN: 0.64MM SQ, COPPER ALLOY
  - PLATING TYPE:
    - GOLD FLASH OVER  
1.25µm MIN. NICKEL OVERALL.
    - GOLD FLASH ON CONTACT AND  
2.50µm MIN. TIN ON SOLDER TAIL OVER  
1.25µm MIN. NICKEL OVERALL.
    - 0.38µm MIN. GOLD PLATE ON CONTACT AND  
2.00µm MIN. TIN ON SOLDER TAIL OVER  
1.25µm MIN. NICKEL OVERALL.
    - 0.75µm MIN. GOLD PLATE ON CONTACT AND  
2.00µm MIN. TIN ON SOLDER TAIL OVER  
1.25µm MIN. NICKEL OVERALL.
    - 2.50µm MIN. TIN OVERALL  
1.25µm MIN. NICKEL OVERALL
  - PRODUCT SPECIFICATION: PS-87920-019
  - PACKAGING TYPE: SEE TABLE
  - PACKAGING SPEC:
    - TUBE WITH CAP VERSION: PK-89990-558
    - TUBE W/O CAP VERSION: PK-89990-545
    - EMBOSS TAPE WITH CAP: PK-87898-400
  - WAFER TO BE FLAT WITHIN 0.003 mm/mm
  - BEND DEPRESSION IS ACCEPTED SO LONG AS IT DOES NOT AFFECT THE OVERALL COPLANARITY OF TAIL
  - COPLANARITY IS TO BE MEASURED BY RESTING THE SOLDER TAIL ON A FLAT SURFACE
  - CAP LOCATION IS CENTERED ALONG THE MATING ENDS AS SHOWN. TOP SURFACE OF CAP TO BE FLAT FOR THE PURPOSE OF PICK & PLACE BY VACUUM SUCTION NOZZLE
  - RECOMMENDED PCB THICKNESS IS 1.60mm±0.10

THIS DRAWING CONTAINS INFORMATION THAT IS PROPRIETARY TO MOLEX ELECTRONIC TECHNOLOGIES, LLC AND SHOULD NOT BE USED WITHOUT WRITTEN PERMISSION											
DIMENSION UNITS		SCALE		CURRENT REV DESC:							
mm		NTS									
GENERAL TOLERANCES (UNLESS SPECIFIED)				EC NO: 745488		DRWN: SUIFR		2023/02/15		CUSTOM HEADER 2.54MM PITCH SINGLE ROW SINGLE WAFER SMT HEADER	
				CHK'D: SUIFR		2023/04/10					
4 PLACES ±				APP'R: MRAMAKRISHNA		2023/04/10		PRODUCT CUSTOMER DRAWING			
3 PLACES ±				INITIAL REVISION:		DRWN: GGUNAGI		2016/11/09		DOCUMENT NUMBER	
2 PLACES ± 0.2				APP'R: ISHWARG		2016/12/06		SD-87898-001		DOC TYPE DOC PART REVISION	
1 PLACE ±				ANGULAR TOL ± 3.0°		DRAWING		SERIES		MATERIAL NUMBER	
0 PLACES ±				DRAFT WHERE APPLICABLE MUST REMAIN WITHIN DIMENSIONS		THIRD ANGLE PROJECTION		DRAWING		CUSTOMER	
						A3-SIZE		87898		SEE TABLE GENERAL MARKET	
										SHEET NUMBER	
										21 OF 21	

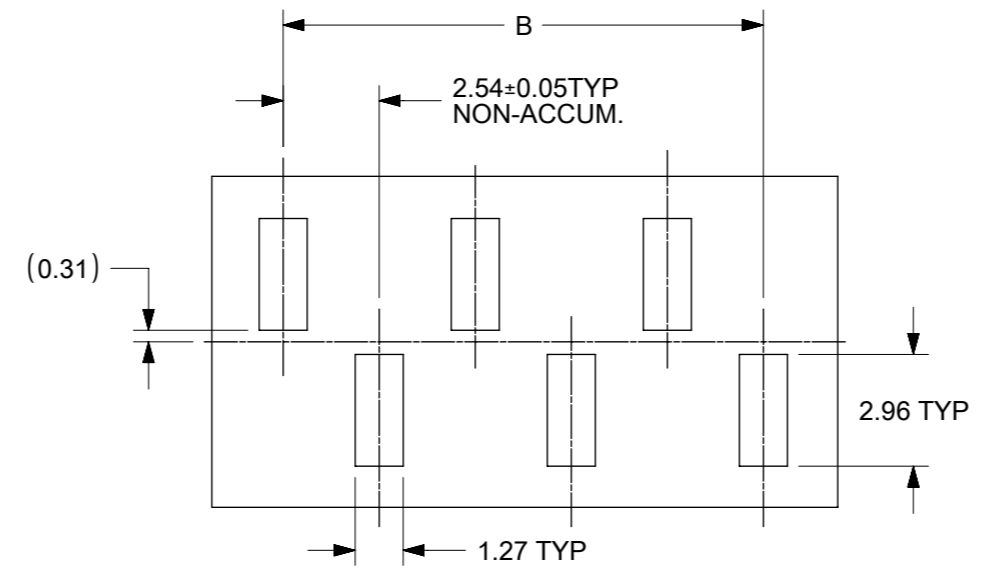
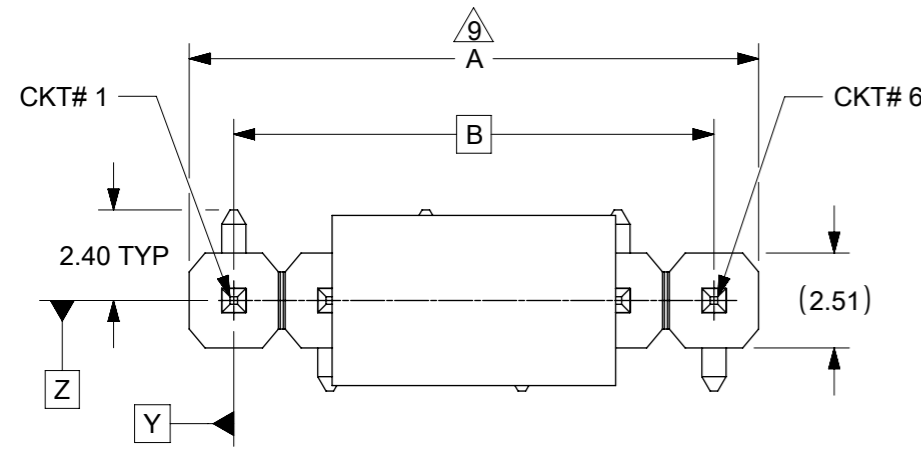

**RECOMMENDED PCB LAYOUT**

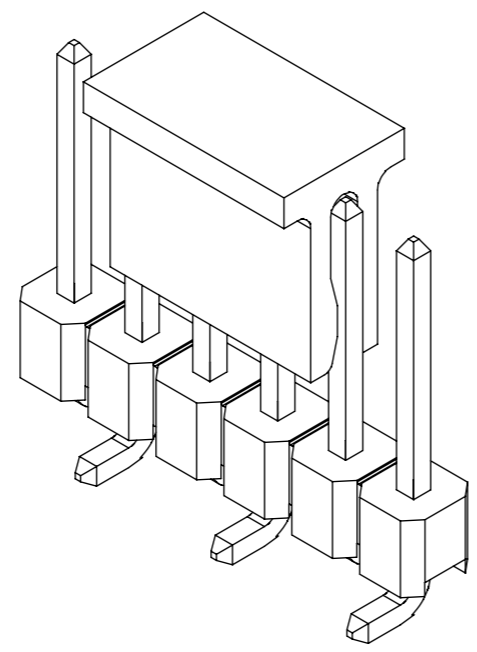
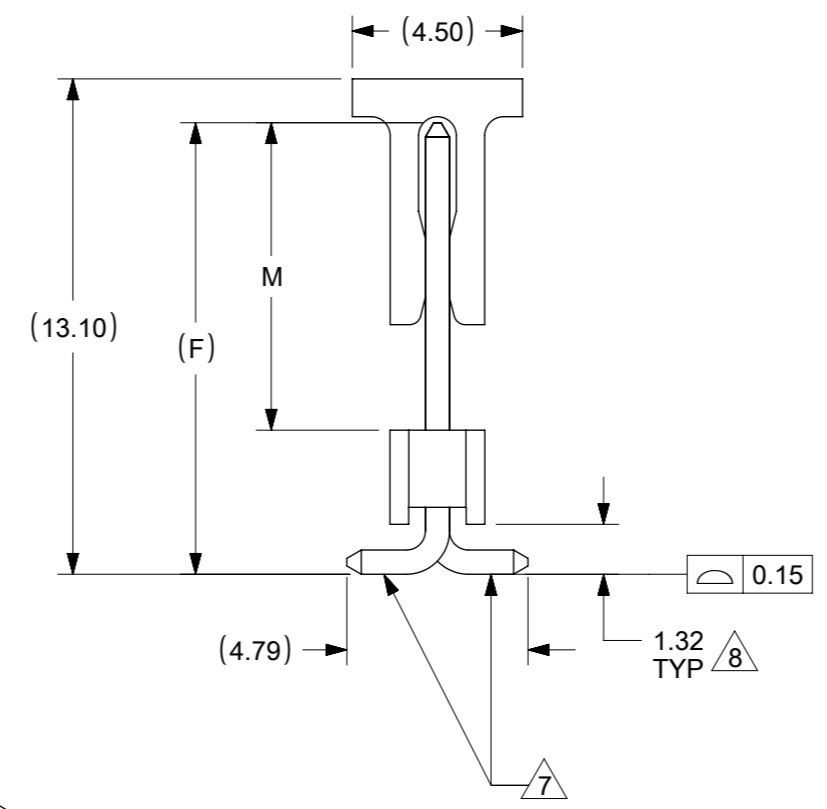
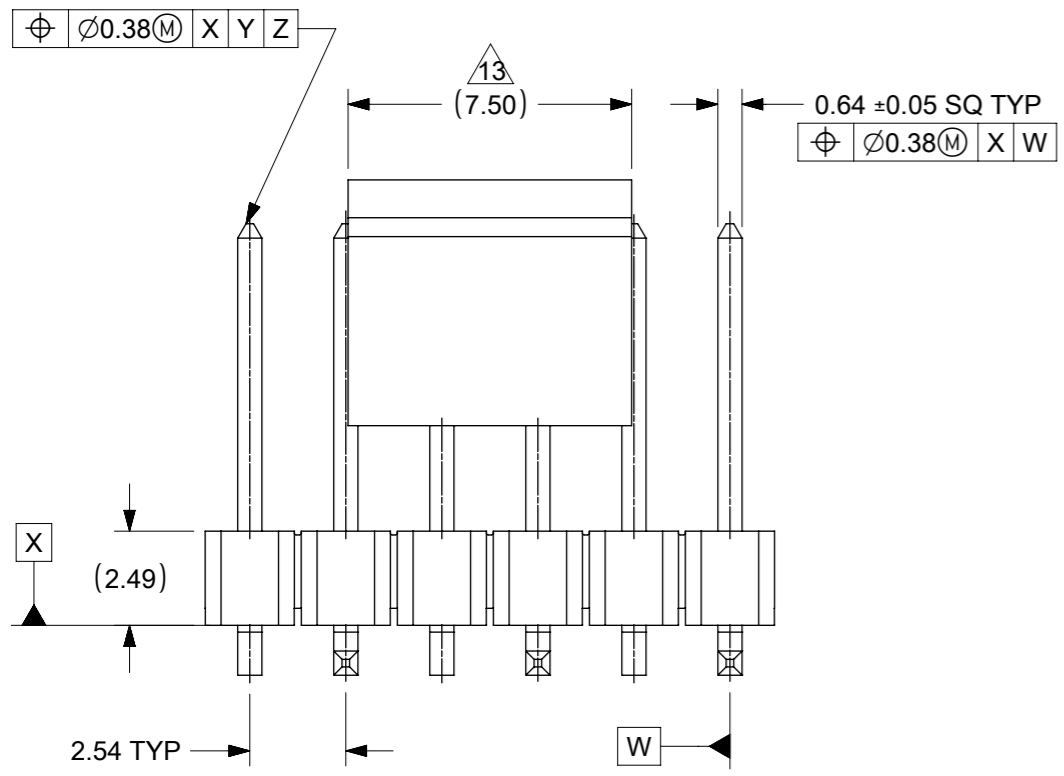

**NOTES:**

1. MATERIAL:  
HSG: NYLON, GLASS-FILLED, UL94V-0, COLOR: BLACK  
PIN: 0.64MM SQ, COPPER ALLOY
2. PLATING TYPE:
  - (1) GOLD FLASH OVER  
1.25µm MIN. NICKEL OVERALL.
  - (2) GOLD FLASH ON CONTACT AND  
2.50µm MIN. TIN ON SOLDER TAIL OVER  
1.25µm MIN. NICKEL OVERALL.
  - (4) 0.38µm MIN. GOLD PLATE ON CONTACT AND  
2.00µm MIN. TIN ON SOLDER TAIL OVER  
1.25µm MIN. NICKEL OVERALL.
  - (5) 0.75µm MIN. GOLD PLATE ON CONTACT AND  
2.00µm MIN. TIN ON SOLDER TAIL OVER  
1.25µm MIN. NICKEL OVERALL.
  - (6) 2.50µm MIN. TIN OVERALL  
1.25µm MIN. NICKEL OVERALL
3. PRODUCT SPECIFICATION: PS-87920-019
4. PACKAGING TYPE: SEE TABLE
5. PACKAGING SPEC: PK-89990-545(TUBE), PK-89990-486(T&R) & PK-87898-400 (T&R)
6. WAFER TO BE FLAT WITHIN 0.003 mm/mm
7. BEND DEPRESSION IS ACCEPTED SO LONG AS IT DOES NOT AFFECT THE OVERALL COPLANARITY OF TAIL
8. COPLANARITY IS TO BE MEASURED BY RESTING THE SOLDER TAIL ON A FLAT SURFACE
9. IRREGULAR CIRCUIT CUTOFF WITHIN BREAKAWAY SECTION IS PERMISSIBLE. CUTTING OR CHIPPING OF THE MAIN BODY IS NOT ACCEPTABLE
10. TUBE LENGTH AS PER STANDARD 560mm
11. RECOMMENDED PCB THICKNESS IS 1.60mm±0.10
12. THE ABOVE CKT 6 IS FOR ILLUSTRATION PURPOSE ONLY
13. CAP LOCATION IS CENTERED ALONG THE MATING ENDS AS SHOWN. TOP SURFACE OF CAP TO BE FLAT FOR THE PURPOSE OF PICK & PLACE BY VACUUM SUCTION NOZZLE.

THIS DRAWING CONTAINS INFORMATION THAT IS PROPRIETARY TO MOLEX ELECTRONIC TECHNOLOGIES, LLC AND SHOULD NOT BE USED WITHOUT WRITTEN PERMISSION		CURRENT REV DESC:		<b>molex</b>	
DIMENSION UNITS: mm		SCALE: NTS			
GENERAL TOLERANCES (UNLESS SPECIFIED)				PRODUCT CUSTOMER DRAWING	
				DOCUMENT NUMBER: SD-87898-003	
4 PLACES ±		MM INCH		DOC TYPE: PSD	
3 PLACES ±				DOC PART: 001	
2 PLACES ± 0.2				REVISION: C1	
1 PLACE ±					
0 PLACES ±					
ANGULAR TOL ± 3.0°					
DRAFT WHERE APPLICABLE MUST REMAIN WITHIN DIMENSIONS		THIRD ANGLE PROJECTION		SHEET NUMBER: 1 OF 17	
		DRAWING: A3-SIZE		SERIES: 87898	
		MATERIAL NUMBER: SEE TABLE		CUSTOMER: GENERAL MARKET	

9 8 7 6 5 4 3 2 1

E  
D  
C  
B  
A

PART WITHOUT CAP  
IN TUBE  
ORIENTATION

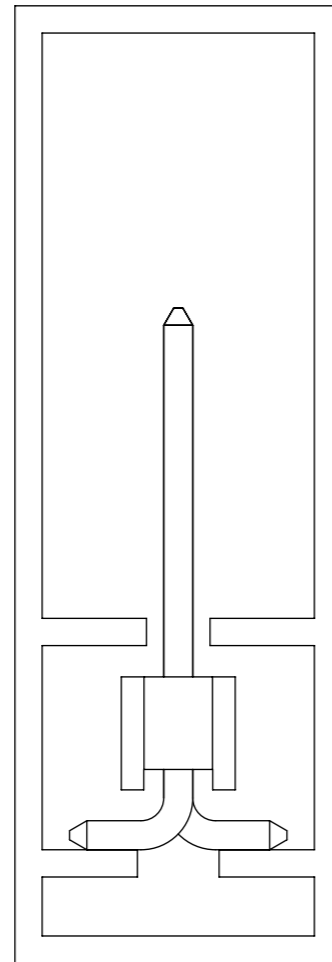

PART WITH CAP  
IN TUBE  
ORIENTATION

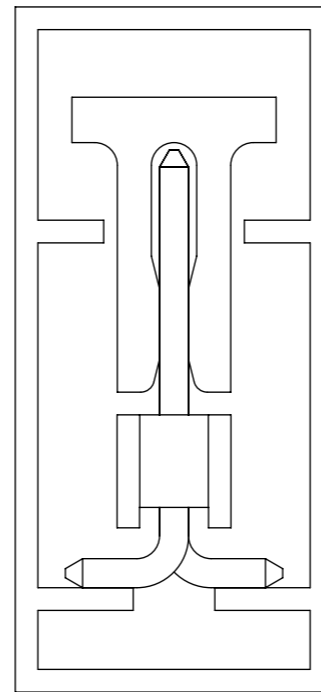

THIS DRAWING CONTAINS INFORMATION THAT IS PROPRIETARY TO MOLEX ELECTRONIC TECHNOLOGIES, LLC AND SHOULD NOT BE USED WITHOUT WRITTEN PERMISSION									
DIMENSION UNITS		SCALE		CURRENT REV DESC:				<b>molex</b>	
mm		NTS							
GENERAL TOLERANCES (UNLESS SPECIFIED)				EC NO: 698212				CUSTOM HEADER 2.54MM PITCH SINGLE ROW SINGLE WAFER SMT HEADER	
		MM	INCH	DRWN: DANUSA 2022/03/03					
4 PLACES		±	±	CHK'D: DANUSA 2022/03/04				PRODUCT CUSTOMER DRAWING	
3 PLACES		±	±	APPR: MRAMAKRISHNA 2022/03/04					
2 PLACES		±	0.2	INITIAL REVISION:				DOCUMENT NUMBER	
1 PLACE		±	±	DRWN: SKLIM01 2005/10/26				SD-87898-003	
0 PLACES		±	±	APPR: PTLIM 2005/11/07				DOC TYPE DOC PART REVISION	
ANGULAR TOL		±	3.0°	DRAWING				PSD 001 C1	
DRAFT WHERE APPLICABLE MUST REMAIN WITHIN DIMENSIONS		THIRD ANGLE PROJECTION		SERIES		MATERIAL NUMBER		CUSTOMER	
				A3-SIZE		87898		GENERAL MARKET	
SHEET NUMBER		2 OF 17							

DOCUMENT STATUS	P1	RELEASE DATE	2022/03/04	09:00:56
-----------------	----	--------------	------------	----------

9 8 7 6 5 4 3 2 1

CKT	DIMENSION						QTY/REEL
	Bo	Ao	Ko	F	So	W	
3	8.02	5.20	13.60	11.50	--	24.00	320
4	10.51	5.79	15.05	14.20	28.40	32.00	250
5	13.10	5.20	13.60	11.50	---	24.00	320

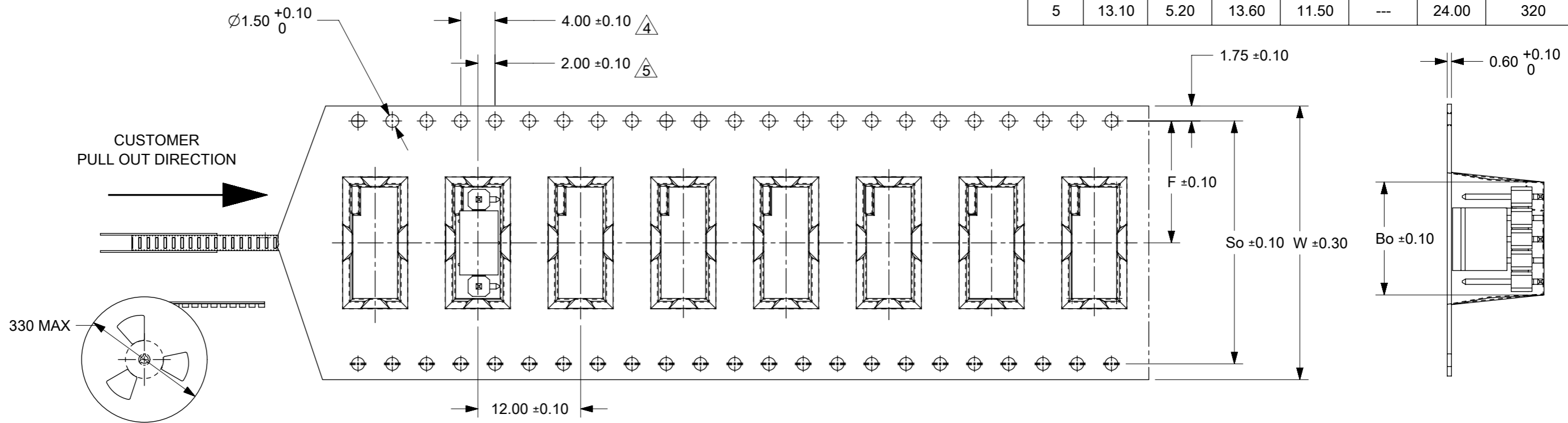

NOTES:

1. LEADER AND TRAILER TAPE

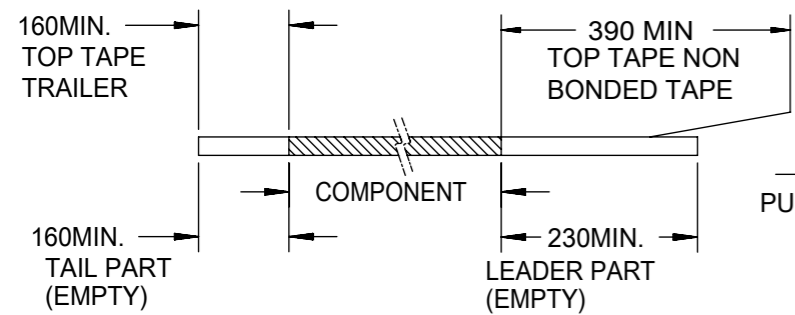

2. PEELING OFF FORCE OF THE TOP TAPE: 20 - 80gf. (PEELING DIRECTION AS SHOWN IN FOLLOWING FIGURE)

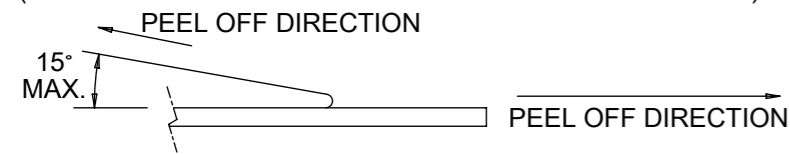

- 3. MATERIAL: BLACK P.S CONDUCTIVE, BLACK
- 4. MEASURED FROM CENTRELINE OF SPROCKET HOLE TO CENTRELINE OF POCKET
- 5. CUMULATIVE TOLERANCE OF 10 SPROCKET HOLE IS  $\pm 0.20\text{mm}$
- 6. A0 AND B0 ARE MEASURE FROM ABOVE POCKET BASE 0.30mm
- 7. TAPE AND REEL SPECIFICATION IS AS PER EIA-481.
- 8. THE TAPE IS TREATED FOR ANTI-STATIC.
- 9. ALL RADIUS ARE 0.30MM UNLESS SPECIFY
- 10. SURFACE RESISTIVITY  $10^3$  TO  $10$  OHMS.

THIS DRAWING CONTAINS INFORMATION THAT IS PROPRIETARY TO MOLEX ELECTRONIC TECHNOLOGIES, LLC AND SHOULD NOT BE USED WITHOUT WRITTEN PERMISSION

DIMENSION UNITS	SCALE	CURRENT REV DESC:		<b>molex</b>		
mm	NTS					
GENERAL TOLERANCES (UNLESS SPECIFIED)		EC NO: 698212		CUSTOMER		
		DRWN: DANUSA 2022/03/03		2.54MM PITCH SINGLE ROW SINGLE WAFER SMT HEADER		
		CHK'D: DANUSA 2022/03/04		PRODUCT CUSTOMER DRAWING		
		APPR: MRAMAKRISHNA 2022/03/04		DOCUMENT NUMBER		
		INITIAL REVISION:		SD-87898-003		
		DRWN: SKLIM01 2005/10/26		DOC TYPE		
		APPR: PTLIM 2005/11/07		PSD		
		ANGULAR TOL $\pm 3.0^\circ$		DOC PART		
		DRAFT WHERE APPLICABLE MUST REMAIN WITHIN DIMENSIONS		001		
		THIRD ANGLE PROJECTION		REVISION		
		DRAWING		C1		
		SERIES		MATERIAL NUMBER		
		A3-SIZE		SEE TABLE		
		87898		CUSTOMER		
				GENERAL MARKET		
				SHEET NUMBER		
				3 OF 17		



9 8 7 6 5 4 3 2 1

PACKAGING OPTION PART NO.						CKT SIZE	VOID POSITION	PLATING TYPE	DIMENSION			
TRAY WITHOUT CAP	TRAY WITH CAP	TUBE WITHOUT CAP	TUBE WITH CAP	TAPE & REEL WITHOUT CAP	TAPE & REEL WITH CAP				A	B	F	M
-----	(C) 87898-0361	-----	-----	-----	-----	3	----	1	7.62	5.08	11.94	8.13
-----	(C) 87898-0362	-----	-----	-----	-----	3	----	2	7.62	5.08	11.94	8.13
-----	(C) 87898-0364	-----	-----	-----	87898-0369	3	----	4	7.62	5.08	11.94	8.13
-----	(C) 87898-0365	-----	-----	-----	-----	3	----	5	7.62	5.08	11.94	8.13
-----	(C) 87898-0366	-----	87898-0367	-----	87898-0368	3	----	6	7.62	5.08	11.94	8.13

E

E

D

D

C

C

B

B

A

A

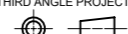
THIS DRAWING CONTAINS INFORMATION THAT IS PROPRIETARY TO MOLEX ELECTRONIC TECHNOLOGIES, LLC AND SHOULD NOT BE USED WITHOUT WRITTEN PERMISSION																
DIMENSION UNITS		SCALE		CURRENT REV DESC:												
mm		NTS														
GENERAL TOLERANCES (UNLESS SPECIFIED)				EC NO: 698212 DRWN: DANUSA 2022/03/03 CHK'D: DANUSA 2022/03/04 APPR: MRAMAKRISHNA 2022/03/04 INITIAL REVISION: DRWN: SKLIM01 2005/10/26 APPR: PTLIM 2005/11/07						CUSTOM HEADER						
										2.54MM PITCH SINGLE ROW SINGLE WAFER SMT HEADER						
										PRODUCT CUSTOMER DRAWING						
										DOCUMENT NUMBER		DOC TYPE	DOC PART	REVISION		
										SD-87898-003		PSD	001	C1		
DRAFT WHERE APPLICABLE MUST REMAIN WITHIN DIMENSIONS				THIRD ANGLE PROJECTION		DRAWING	SERIES	MATERIAL NUMBER	CUSTOMER		SHEET NUMBER					
						A3-SIZE	87898	SEE TABLE	GENERAL MARKET		4 OF 17					

DOCUMENT STATUS	P1	RELEASE DATE	2022/03/04	09:00:56
-----------------	----	--------------	------------	----------

9 8 7 6 5 4 3 2 1

FORMAT: Mel-lega-master-ib-prod-A3  
 REVISION: D  
 DATE: 2018/01/18

PACKAGING OPTION PART NO.						CKT SIZE	PEG	VOID POSITION	PLATING TYPE	DIMENSION			
TRAY WITHOUT CAP	TRAY WITH CAP	TUBE WITHOUT CAP	TUBE WITH CAP	TAPE & REEL WITHOUT CAP	TAPE & REEL WITH CAP					A	B	F	M
-----	-----	87898-0461	-----	-----	-----	4	---	----	1	10.16	7.62	11.94	8.13
-----	-----	87898-0462	-----	-----	-----	4	---	----	2	10.16	7.62	11.94	8.13
-----	-----	87898-0464	-----	-----	-----	4	---	----	4	10.16	7.62	11.94	8.13
-----	-----	87898-0465	-----	-----	-----	4	---	----	5	10.16	7.62	11.94	8.13
-----	-----	87898-0466	-----	-----	87898-0467	4	---	----	6	10.16	7.62	11.94	8.13
-----	-----	-----	-----	-----	87898-0468	4	Y	----	6	10.16	7.62	11.94	8.13
-----	-----	-----	-----	87898-0489	-----	4	Y	----	5	10.16	7.62	16.74	12.93
-----	-----	87898-0561	-----	-----	-----	5	---	----	1	12.70	10.16	11.94	8.13
-----	-----	87898-0562	-----	-----	-----	5	---	----	2	12.70	10.16	11.94	8.13
-----	-----	87898-0564	-----	-----	-----	5	---	----	4	12.70	10.16	11.94	8.13
-----	-----	87898-0565	-----	-----	-----	5	---	----	5	12.70	10.16	11.94	8.13
-----	-----	87898-0566	87898-0567	-----	87898-0568	5	---	----	6	12.70	10.16	11.94	8.13
-----	-----	87898-0661	-----	-----	-----	6	---	----	1	15.24	12.70	11.94	8.13
-----	-----	87898-0662	-----	-----	-----	6	---	----	2	15.24	12.70	11.94	8.13
-----	-----	87898-0664	-----	-----	-----	6	---	----	4	15.24	12.70	11.94	8.13
-----	-----	87898-0665	-----	-----	(C) -----	6	---	----	5	15.24	12.70	11.94	8.13
-----	-----	87898-0666	-----	-----	87898-0605	6	---	----	6	15.24	12.70	11.94	8.13

4 CKT WITH PEG FOR ILLUSTRATION ONLY

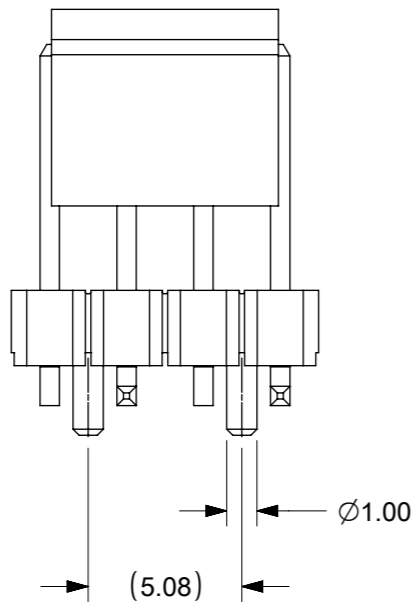

THIS DRAWING CONTAINS INFORMATION THAT IS PROPRIETARY TO MOLEX ELECTRONIC TECHNOLOGIES, LLC AND SHOULD NOT BE USED WITHOUT WRITTEN PERMISSION											
DIMENSION UNITS		SCALE		CURRENT REV DESC:							
mm		NTS									
GENERAL TOLERANCES (UNLESS SPECIFIED)				EC NO: 698212		DRWN: DANUSA		2022/03/03		CUSTOMER	
				DRWN: DANUSA		2022/03/04		2.54MM PITCH SINGLE ROW SINGLE WAFER SMT HEADER			
				APP: MRAMAKRISHNA		2022/03/04		PRODUCT CUSTOMER DRAWING			
4 PLACES ±				INITIAL REVISION:		DRWN: SKLIM01		2005/10/26		DOCUMENT NUMBER	
3 PLACES ±				APP: PTLIM		2005/11/07		SD-87898-003		DOC TYPE DOC PART REVISION	
2 PLACES ± 0.2				THIRD ANGLE PROJECTION		DRAWING		SERIES		MATERIAL NUMBER	
1 PLACE ±				DRAFT WHERE APPLICABLE MUST REMAIN WITHIN DIMENSIONS		A3-SIZE		87898		CUSTOMER	
0 PLACES ±				ANGULAR TOL ± 3.0°				SEE TABLE		GENERAL MARKET	
DOCUMENT STATUS				P1		RELEASE DATE		2022/03/04 09:00:56		SHEET NUMBER	
								5 OF 17			

PACKAGING OPTION PART NO.						CKT SIZE	VOID POSITION	PLATING TYPE	DIMENSION			
TRAY WITHOUT CAP	TRAY WITH CAP	TUBE WITHOUT CAP	TUBE WITH CAP	TAPE & REEL WITHOUT CAP	TAPE & REEL WITH CAP				A	B	F	M
-----	-----	87898-0761	-----	-----	-----	7	----	1	17.78	15.24	11.94	8.13
-----	-----	87898-0762	-----	-----	-----	7	----	2	17.78	15.24	11.94	8.13
-----	-----	87898-0764	-----	-----	-----	7	----	4	17.78	15.24	11.94	8.13
-----	-----	87898-0765	-----	-----	-----	7	----	5	17.78	15.24	11.94	8.13
-----	-----	87898-0766	-----	-----	-----	7	----	6	17.78	15.24	11.94	8.13
-----	-----	87898-0861	-----	-----	-----	8	----	1	20.32	17.78	11.94	8.13
-----	-----	87898-0862	-----	-----	-----	8	----	2	20.32	17.78	11.94	8.13
-----	-----	87898-0864	-----	-----	-----	8	----	4	20.32	17.78	11.94	8.13
-----	-----	87898-0865	-----	-----	-----	8	----	5	20.32	17.78	11.94	8.13
-----	-----	87898-0866	-----	-----	-----	8	----	6	20.32	17.78	11.94	8.13
-----	-----	87898-0961	-----	-----	-----	9	----	1	22.86	20.32	11.94	8.13
-----	-----	87898-0962	-----	-----	-----	9	----	2	22.86	20.32	11.94	8.13
-----	-----	87898-0964	-----	-----	-----	9	----	4	22.86	20.32	11.94	8.13
-----	-----	87898-0965	-----	-----	-----	9	----	5	22.86	20.32	11.94	8.13
-----	-----	87898-0966	-----	-----	-----	9	----	6	22.86	20.32	11.94	8.13

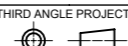
THIS DRAWING CONTAINS INFORMATION THAT IS PROPRIETARY TO MOLEX ELECTRONIC TECHNOLOGIES, LLC AND SHOULD NOT BE USED WITHOUT WRITTEN PERMISSION											
DIMENSION UNITS		SCALE		CURRENT REV DESC:							
mm		NTS									
GENERAL TOLERANCES (UNLESS SPECIFIED)				EC NO: 698212 DRWN: DANUSA 2022/03/03 CHK'D: DANUSA 2022/03/04 APPR: MRAMAKRISHNA 2022/03/04						CUSTOM HEADER 2.54MM PITCH SINGLE ROW SINGLE WAFER SMT HEADER	
4 PLACES		±	±	INITIAL REVISION: DRWN: SKLIM01 2005/10/26 APPR: PTLIM 2005/11/07						PRODUCT CUSTOMER DRAWING	
3 PLACES		±	±								
2 PLACES		± 0.2	±	DOCUMENT NUMBER <b>SD-87898-003</b>						DOC TYPE PSD	
1 PLACE		±	±								
0 PLACES		±	±	DOC PART 001						REVISION C1	
ANGULAR TOL		± 3.0°									
DRAFT WHERE APPLICABLE MUST REMAIN WITHIN DIMENSIONS				THIRD ANGLE PROJECTION		DRAWING		SERIES		MATERIAL NUMBER	
						A3-SIZE		87898		SEE TABLE	
						GENERAL MARKET				SHEET NUMBER 6 OF 17	

PACKAGING OPTION PART NO.						CKT SIZE	VOID POSITION	PLATING TYPE	DIMENSION			
TRAY WITHOUT CAP	TRAY WITH CAP	TUBE WITHOUT CAP	TUBE WITH CAP	TAPE & REEL WITHOUT CAP	TAPE & REEL WITH CAP				A	B	F	M
-----	-----	87898-1061	-----	-----	-----	10	----	1	25.40	22.86	11.94	8.13
-----	-----	87898-1062	-----	-----	-----	10	----	2	25.40	22.86	11.94	8.13
-----	-----	87898-1064	-----	-----	-----	10	----	4	25.40	22.86	11.94	8.13
-----	-----	87898-1065	-----	-----	-----	10	----	5	25.40	22.86	11.94	8.13
-----	-----	87898-1066	-----	-----	-----	10	----	6	25.40	22.86	11.94	8.13
-----	-----	87898-1161	-----	-----	-----	11	----	1	27.94	25.40	11.94	8.13
-----	-----	87898-1162	-----	-----	-----	11	----	2	27.94	25.40	11.94	8.13
-----	-----	87898-1164	-----	-----	-----	11	----	4	27.94	25.40	11.94	8.13
-----	-----	87898-1165	-----	-----	-----	11	----	5	27.94	25.40	11.94	8.13
-----	-----	87898-1166	-----	-----	-----	11	----	6	27.94	25.40	11.94	8.13
-----	-----	87898-1261	-----	-----	-----	12	----	1	30.48	27.94	11.94	8.13
-----	-----	87898-1262	-----	-----	-----	12	----	2	30.48	27.94	11.94	8.13
-----	-----	87898-1264	-----	-----	-----	12	----	4	30.48	27.94	11.94	8.13
-----	-----	87898-1265	-----	-----	-----	12	----	5	30.48	27.94	11.94	8.13
-----	-----	87898-1266	-----	-----	-----	12	----	6	30.48	27.94	11.94	8.13

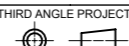
THIS DRAWING CONTAINS INFORMATION THAT IS PROPRIETARY TO MOLEX ELECTRONIC TECHNOLOGIES, LLC AND SHOULD NOT BE USED WITHOUT WRITTEN PERMISSION													
DIMENSION UNITS		SCALE		CURRENT REV DESC:									
mm		NTS											
GENERAL TOLERANCES (UNLESS SPECIFIED)				EC NO: 698212 DRWN: DANUSA 2022/03/03 CHK'D: DANUSA 2022/03/04 APPR: MRAMAKRISHNA 2022/03/04						CUSTOM HEADER 2.54MM PITCH SINGLE ROW SINGLE WAFER SMT HEADER			
		MM	INCH										
4 PLACES	±		±	INITIAL REVISION: DRWN: SKLIM01 2005/10/26 APPR: PTLIM 2005/11/07						PRODUCT CUSTOMER DRAWING DOCUMENT NUMBER: SD-87898-003 DOC TYPE: PSD DOC PART: 001 REVISION: C1			
3 PLACES	±		±										
2 PLACES	±	0.2	±	DRAFT WHERE APPLICABLE MUST REMAIN WITHIN DIMENSIONS						THIRD ANGLE PROJECTION  DRAWING: A3-SIZE SERIES: 87898 MATERIAL NUMBER: SEE TABLE CUSTOMER: GENERAL MARKET SHEET NUMBER: 7 OF 17			
1 PLACE	±		±										
0 PLACES	±		±										
ANGULAR TOL ± 3.0°													

PACKAGING OPTION PART NO.						CKT SIZE	VOID POSITION	PLATING TYPE	DIMENSION			
TRAY WITHOUT CAP	TRAY WITH CAP	TUBE WITHOUT CAP	TUBE WITH CAP	TAPE & REEL WITHOUT CAP	TAPE & REEL WITH CAP				A	B	F	M
-----	-----	87898-1361	-----	-----	-----	13	----	1	33.02	30.48	11.94	8.13
-----	-----	87898-1362	-----	-----	-----	13	----	2	33.02	30.48	11.94	8.13
-----	-----	87898-1364	-----	-----	-----	13	----	4	33.02	30.48	11.94	8.13
-----	-----	87898-1365	-----	-----	-----	13	----	5	33.02	30.48	11.94	8.13
-----	-----	87898-1366	-----	-----	-----	13	----	6	33.02	30.48	11.94	8.13
-----	-----	87898-1461	-----	-----	-----	14	----	1	35.56	33.02	11.94	8.13
-----	-----	87898-1462	-----	-----	-----	14	----	2	35.56	33.02	11.94	8.13
-----	-----	87898-1464	-----	-----	-----	14	----	4	35.56	33.02	11.94	8.13
-----	-----	87898-1465	-----	-----	-----	14	----	5	35.56	33.02	11.94	8.13
-----	-----	87898-1466	-----	-----	-----	14	----	6	35.56	33.02	11.94	8.13
-----	-----	87898-1561	-----	-----	-----	15	----	1	38.10	35.56	11.94	8.13
-----	-----	87898-1562	-----	-----	-----	15	----	2	38.10	35.56	11.94	8.13
-----	-----	87898-1564	-----	-----	-----	15	----	4	38.10	35.56	11.94	8.13
-----	-----	87898-1565	-----	-----	-----	15	----	5	38.10	35.56	11.94	8.13
-----	-----	87898-1566	-----	-----	-----	15	----	6	38.10	35.56	11.94	8.13

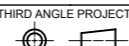
THIS DRAWING CONTAINS INFORMATION THAT IS PROPRIETARY TO MOLEX ELECTRONIC TECHNOLOGIES, LLC AND SHOULD NOT BE USED WITHOUT WRITTEN PERMISSION													
DIMENSION UNITS		SCALE		CURRENT REV DESC:									
mm		NTS											
GENERAL TOLERANCES (UNLESS SPECIFIED)				EC NO: 698212 DRWN: DANUSA 2022/03/03 CHK'D: DANUSA 2022/03/04 APPR: MRAMAKRISHNA 2022/03/04						CUSTOM HEADER 2.54MM PITCH SINGLE ROW SINGLE WAFER SMT HEADER			
		MM	INCH										
4 PLACES	±		±	INITIAL REVISION: DRWN: SKLIM01 2005/10/26 APPR: PTLIM 2005/11/07						PRODUCT CUSTOMER DRAWING DOCUMENT NUMBER: SD-87898-003 DOC TYPE: PSD DOC PART: 001 REVISION: C1			
3 PLACES	±		±										
2 PLACES	±	0.2	±	DRAFT WHERE APPLICABLE MUST REMAIN WITHIN DIMENSIONS						THIRD ANGLE PROJECTION 			
1 PLACE	±		±										
0 PLACES	±		±	DRAWING		SERIES		MATERIAL NUMBER		CUSTOMER		SHEET NUMBER	
ANGULAR TOL ± 3.0°				A3-SIZE		87898		SEE TABLE		GENERAL MARKET		8 OF 17	

PACKAGING OPTION PART NO.						CKT SIZE	VOID POSITION	PLATING TYPE	DIMENSION			
TRAY WITHOUT CAP	TRAY WITH CAP	TUBE WITHOUT CAP	TUBE WITH CAP	TAPE & REEL WITHOUT CAP	TAPE & REEL WITH CAP				A	B	F	M
-----	-----	87898-1661	-----	-----	-----	16	----	1	40.64	38.10	11.94	8.13
-----	-----	87898-1662	-----	-----	-----	16	----	2	40.64	38.10	11.94	8.13
-----	-----	87898-1664	-----	-----	-----	16	----	4	40.64	38.10	11.94	8.13
-----	-----	87898-1665	-----	-----	-----	16	----	5	40.64	38.10	11.94	8.13
-----	-----	87898-1666	-----	-----	-----	16	----	6	40.64	38.10	11.94	8.13
-----	-----	87898-1761	-----	-----	-----	17	----	1	43.18	40.64	11.94	8.13
-----	-----	87898-1762	-----	-----	-----	17	----	2	43.18	40.64	11.94	8.13
-----	-----	87898-1764	-----	-----	-----	17	----	4	43.18	40.64	11.94	8.13
-----	-----	87898-1765	-----	-----	-----	17	----	5	43.18	40.64	11.94	8.13
-----	-----	87898-1766	-----	-----	-----	17	----	6	43.18	40.64	11.94	8.13
-----	-----	87898-1861	-----	-----	-----	18	----	1	45.72	43.18	11.94	8.13
-----	-----	87898-1862	-----	-----	-----	18	----	2	45.72	43.18	11.94	8.13
-----	-----	87898-1864	-----	-----	-----	18	----	4	45.72	43.18	11.94	8.13
-----	-----	87898-1865	-----	-----	-----	18	----	5	45.72	43.18	11.94	8.13
-----	-----	87898-1866	-----	-----	-----	18	----	6	45.72	43.18	11.94	8.13

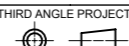
THIS DRAWING CONTAINS INFORMATION THAT IS PROPRIETARY TO MOLEX ELECTRONIC TECHNOLOGIES, LLC AND SHOULD NOT BE USED WITHOUT WRITTEN PERMISSION																					
DIMENSION UNITS		SCALE		CURRENT REV DESC:																	
mm		NTS																			
GENERAL TOLERANCES (UNLESS SPECIFIED)				EC NO: 698212 DRWN: DANUSA 2022/03/03 CHK'D: DANUSA 2022/03/04 APPR: MRAMAKRISHNA 2022/03/04						CUSTOM HEADER 2.54MM PITCH SINGLE ROW SINGLE WAFER SMT HEADER											
		MM	INCH																		
4 PLACES	±		±	INITIAL REVISION: DRWN: SKLIM01 2005/10/26 APPR: PTLIM 2005/11/07						DOCUMENT NUMBER <b>SD-87898-003</b>		DOC TYPE PSD	DOC PART 001	REVISION C1							
3 PLACES	±		±																		
2 PLACES	±	0.2	±	DRAFT WHERE APPLICABLE MUST REMAIN WITHIN DIMENSIONS						THIRD ANGLE PROJECTION 		DRAWING <b>A3-SIZE</b>		SERIES <b>87898</b>		MATERIAL NUMBER SEE TABLE		CUSTOMER GENERAL MARKET		SHEET NUMBER 9 OF 17	
1 PLACE	±		±																		
0 PLACES	±		±	ANGULAR TOL		± 3.0°															

PACKAGING OPTION PART NO.						CKT SIZE	VOID POSITION	PLATING TYPE	DIMENSION			
TRAY WITHOUT CAP	TRAY WITH CAP	TUBE WITHOUT CAP	TUBE WITH CAP	TAPE & REEL WITHOUT CAP	TAPE & REEL WITH CAP				A	B	F	M
-----	-----	87898-1961	-----	-----	-----	19	----	1	48.26	45.72	11.94	8.13
-----	-----	87898-1962	-----	-----	-----	19	----	2	48.26	45.72	11.94	8.13
-----	-----	87898-1964	-----	-----	-----	19	----	4	48.26	45.72	11.94	8.13
-----	-----	87898-1965	-----	-----	-----	19	----	5	48.26	45.72	11.94	8.13
-----	-----	87898-1966	-----	-----	-----	19	----	6	48.26	45.72	11.94	8.13
-----	-----	87898-2061	-----	-----	-----	20	----	1	50.80	48.26	11.94	8.13
-----	-----	87898-2062	-----	-----	-----	20	----	2	50.80	48.26	11.94	8.13
-----	-----	87898-2064	-----	-----	-----	20	----	4	50.80	48.26	11.94	8.13
-----	-----	87898-2065	-----	-----	-----	20	----	5	50.80	48.26	11.94	8.13
-----	-----	87898-2066	-----	-----	-----	20	----	6	50.80	48.26	11.94	8.13
-----	-----	87898-2161	-----	-----	-----	21	----	1	53.34	50.80	11.94	8.13
-----	-----	87898-2162	-----	-----	-----	21	----	2	53.34	50.80	11.94	8.13
-----	-----	87898-2164	-----	-----	-----	21	----	4	53.34	50.80	11.94	8.13
-----	-----	87898-2165	-----	-----	-----	21	----	5	53.34	50.80	11.94	8.13
-----	-----	87898-2166	-----	-----	-----	21	----	6	53.34	50.80	11.94	8.13

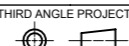
THIS DRAWING CONTAINS INFORMATION THAT IS PROPRIETARY TO MOLEX ELECTRONIC TECHNOLOGIES, LLC AND SHOULD NOT BE USED WITHOUT WRITTEN PERMISSION													
DIMENSION UNITS		SCALE		CURRENT REV DESC:									
mm		NTS											
GENERAL TOLERANCES (UNLESS SPECIFIED)				EC NO: 698212 DRWN: DANUSA 2022/03/03 CHK'D: DANUSA 2022/03/04 APPR: MRAMAKRISHNA 2022/03/04						CUSTOM HEADER 2.54MM PITCH SINGLE ROW SINGLE WAFER SMT HEADER			
		MM	INCH										
4 PLACES	±		±	INITIAL REVISION: DRWN: SKLIM01 2005/10/26 APPR: PTLIM 2005/11/07						PRODUCT CUSTOMER DRAWING DOCUMENT NUMBER: SD-87898-003 DOC TYPE: PSD DOC PART: 001 REVISION: C1			
3 PLACES	±		±										
2 PLACES	±	0.2	±	DRAFT WHERE APPLICABLE MUST REMAIN WITHIN DIMENSIONS						THIRD ANGLE PROJECTION 			
1 PLACE	±		±										
0 PLACES	±		±	DRAWING		SERIES		MATERIAL NUMBER		CUSTOMER		SHEET NUMBER	
ANGULAR TOL ± 3.0°				A3-SIZE		87898		SEE TABLE		GENERAL MARKET		10 OF 17	

PACKAGING OPTION PART NO.						CKT SIZE	VOID POSITION	PLATING TYPE	DIMENSION			
TRAY WITHOUT CAP	TRAY WITH CAP	TUBE WITHOUT CAP	TUBE WITH CAP	TAPE & REEL WITHOUT CAP	TAPE & REEL WITH CAP				A	B	F	M
-----	-----	87898-2261	-----	-----	-----	22	----	1	55.88	53.34	11.94	8.13
-----	-----	87898-2262	-----	-----	-----	22	----	2	55.88	53.34	11.94	8.13
-----	-----	87898-2264	-----	-----	-----	22	----	4	55.88	53.34	11.94	8.13
-----	-----	87898-2265	-----	-----	-----	22	----	5	55.88	53.34	11.94	8.13
-----	-----	87898-2266	-----	-----	-----	22	----	6	55.88	53.34	11.94	8.13
-----	-----	87898-2361	-----	-----	-----	23	----	1	58.42	55.88	11.94	8.13
-----	-----	87898-2362	-----	-----	-----	23	----	2	58.42	55.88	11.94	8.13
-----	-----	87898-2364	-----	-----	-----	23	----	4	58.42	55.88	11.94	8.13
-----	-----	87898-2365	-----	-----	-----	23	----	5	58.42	55.88	11.94	8.13
-----	-----	87898-2366	-----	-----	-----	23	----	6	58.42	55.88	11.94	8.13
-----	-----	87898-2461	-----	-----	-----	24	----	1	60.96	58.42	11.94	8.13
-----	-----	87898-2462	-----	-----	-----	24	----	2	60.96	58.42	11.94	8.13
-----	-----	87898-2464	-----	-----	-----	24	----	4	60.96	58.42	11.94	8.13
-----	-----	87898-2465	-----	-----	-----	24	----	5	60.96	58.42	11.94	8.13
-----	-----	87898-2466	-----	-----	-----	24	----	6	60.96	58.42	11.94	8.13

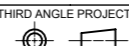
THIS DRAWING CONTAINS INFORMATION THAT IS PROPRIETARY TO MOLEX ELECTRONIC TECHNOLOGIES, LLC AND SHOULD NOT BE USED WITHOUT WRITTEN PERMISSION												
DIMENSION UNITS		SCALE		CURRENT REV DESC:								
mm		NTS										
GENERAL TOLERANCES (UNLESS SPECIFIED)				EC NO: 698212 DRWN: DANUSA 2022/03/03 CHK'D: DANUSA 2022/03/04 APPR: MRAMAKRISHNA 2022/03/04				CUSTOM HEADER 2.54MM PITCH SINGLE ROW SINGLE WAFER SMT HEADER				
		MM	INCH									
4 PLACES	±		±	INITIAL REVISION: DRWN: SKLIM01 2005/10/26 APPR: PTLIM 2005/11/07				DOCUMENT NUMBER		DOC TYPE	DOC PART	REVISION
3 PLACES	±		±					SD-87898-003		PSD	001	C1
2 PLACES	±	0.2	±	DRAFT WHERE APPLICABLE MUST REMAIN WITHIN DIMENSIONS				MATERIAL NUMBER		CUSTOMER		SHEET NUMBER
1 PLACE	±		±					SEE TABLE		GENERAL MARKET		11 OF 17
0 PLACES	±		±	THIRD ANGLE PROJECTION		DRAWING	SERIES	CUSTOMER		SHEET NUMBER		
ANGULAR TOL		± 3.0°				A3-SIZE	87898	GENERAL MARKET		11 OF 17		



PACKAGING OPTION PART NO.						CKT SIZE	VOID POSITION	PLATING TYPE	DIMENSION			
TRAY WITHOUT CAP	TRAY WITH CAP	TUBE WITHOUT CAP	TUBE WITH CAP	TAPE & REEL WITHOUT CAP	TAPE & REEL WITH CAP				A	B	F	M
-----	-----	87898-2561	-----	-----	-----	25	----	1	63.50	60.96	11.94	8.13
-----	-----	87898-2562	-----	-----	-----	25	----	2	63.50	60.96	11.94	8.13
-----	-----	87898-2564	-----	-----	-----	25	----	4	63.50	60.96	11.94	8.13
-----	-----	87898-2565	-----	-----	-----	25	----	5	63.50	60.96	11.94	8.13
-----	-----	87898-2566	-----	-----	-----	25	----	6	63.50	60.96	11.94	8.13
-----	-----	87898-2661	-----	-----	-----	26	----	1	66.04	63.50	11.94	8.13
-----	-----	87898-2662	-----	-----	-----	26	----	2	66.04	63.50	11.94	8.13
-----	-----	87898-2664	-----	-----	-----	26	----	4	66.04	63.50	11.94	8.13
-----	-----	87898-2665	-----	-----	-----	26	----	5	66.04	63.50	11.94	8.13
-----	-----	87898-2666	-----	-----	-----	26	----	6	66.04	63.50	11.94	8.13
-----	-----	87898-2761	-----	-----	-----	27	----	1	68.58	66.04	11.94	8.13
-----	-----	87898-2762	-----	-----	-----	27	----	2	68.58	66.04	11.94	8.13
-----	-----	87898-2764	-----	-----	-----	27	----	4	68.58	66.04	11.94	8.13
-----	-----	87898-2765	-----	-----	-----	27	----	5	68.58	66.04	11.94	8.13
-----	-----	87898-2766	-----	-----	-----	27	----	6	68.58	66.04	11.94	8.13

THIS DRAWING CONTAINS INFORMATION THAT IS PROPRIETARY TO MOLEX ELECTRONIC TECHNOLOGIES, LLC AND SHOULD NOT BE USED WITHOUT WRITTEN PERMISSION

DIMENSION UNITS		SCALE		CURRENT REV DESC:				<b>molex</b>			
mm		NTS		EC NO: 698212							
GENERAL TOLERANCES (UNLESS SPECIFIED)				DRWN: DANUSA 2022/03/03				2.54MM PITCH SINGLE ROW SINGLE WAFER SMT HEADER			
				CHK'D: DANUSA 2022/03/04				PRODUCT CUSTOMER DRAWING			
				APPR: MRAMAKRISHNA 2022/03/04				DOCUMENT NUMBER			
4 PLACES ±				INITIAL REVISION:				SD-87898-003			
3 PLACES ±				DRWN: SKLIM01 2005/10/26				DOC TYPE			
2 PLACES ± 0.2				APPR: PTLIM 2005/11/07				PSD			
1 PLACE ±								DOC PART			
0 PLACES ±								001			
ANGULAR TOL ± 3.0°				THIRD ANGLE PROJECTION				REVISION			
DRAFT WHERE APPLICABLE MUST REMAIN WITHIN DIMENSIONS				DRAWING				SHEET NUMBER			
				A3-SIZE				12 OF 17			
				SERIES				CUSTOMER			
				87898				GENERAL MARKET			
				MATERIAL NUMBER							
				SEE TABLE							

PACKAGING OPTION PART NO.						CKT SIZE	VOID POSITION	PLATING TYPE	DIMENSION			
TRAY WITHOUT CAP	TRAY WITH CAP	TUBE WITHOUT CAP	TUBE WITH CAP	TAPE & REEL WITHOUT CAP	TAPE & REEL WITH CAP				A	B	F	M
-----	-----	87898-2861	-----	-----	-----	28	----	1	71.12	68.58	11.94	8.13
-----	-----	87898-2862	-----	-----	-----	28	----	2	71.12	68.58	11.94	8.13
-----	-----	87898-2864	-----	-----	-----	28	----	4	71.12	68.58	11.94	8.13
-----	-----	87898-2865	-----	-----	-----	28	----	5	71.12	68.58	11.94	8.13
-----	-----	87898-2866	-----	-----	-----	28	----	6	71.12	68.58	11.94	8.13
-----	-----	87898-2961	-----	-----	-----	29	----	1	73.66	71.12	11.94	8.13
-----	-----	87898-2962	-----	-----	-----	29	----	2	73.66	71.12	11.94	8.13
-----	-----	87898-2964	-----	-----	-----	29	----	4	73.66	71.12	11.94	8.13
-----	-----	87898-2965	-----	-----	-----	29	----	5	73.66	71.12	11.94	8.13
-----	-----	87898-2966	-----	-----	-----	29	----	6	73.66	71.12	11.94	8.13
-----	-----	87898-3061	-----	-----	-----	30	----	1	76.20	73.66	11.94	8.13
-----	-----	87898-3062	-----	-----	-----	30	----	2	76.20	73.66	11.94	8.13
-----	-----	87898-3064	-----	-----	-----	30	----	4	76.20	73.66	11.94	8.13
-----	-----	87898-3065	-----	-----	-----	30	----	5	76.20	73.66	11.94	8.13
-----	-----	87898-3066	-----	-----	-----	30	----	6	76.20	73.66	11.94	8.13

THIS DRAWING CONTAINS INFORMATION THAT IS PROPRIETARY TO MOLEX ELECTRONIC TECHNOLOGIES, LLC AND SHOULD NOT BE USED WITHOUT WRITTEN PERMISSION

DIMENSION UNITS		SCALE		CURRENT REV DESC:		<b>molex</b>	
mm		NTS		EC NO: 698212			
GENERAL TOLERANCES (UNLESS SPECIFIED)				DRWN: DANUSA 2022/03/03		CUSTOM HEADER 2.54MM PITCH SINGLE ROW SINGLE WAFER SMT HEADER	
				CHK'D: DANUSA 2022/03/04			
				APPR: MRAMAKRISHNA 2022/03/04		PRODUCT CUSTOMER DRAWING	
4 PLACES ±				INITIAL REVISION:		DOCUMENT NUMBER	
3 PLACES ±				DRWN: SKLIM01 2005/10/26		SD-87898-003	
2 PLACES ± 0.2				APPR: PTLIM 2005/11/07		DOC TYPE DOC PART REVISION	
1 PLACE ±						PSD 001 C1	
0 PLACES ±							
ANGULAR TOL ± 3.0°				THIRD ANGLE PROJECTION		MATERIAL NUMBER	
DRAFT WHERE APPLICABLE MUST REMAIN WITHIN DIMENSIONS				DRAWING		CUSTOMER	
				A3-SIZE		GENERAL MARKET	
				SERIES		SHEET NUMBER	
				87898		13 OF 17	

PACKAGING OPTION PART NO.						CKT SIZE	VOID POSITION	PLATING TYPE	DIMENSION			
TRAY WITHOUT CAP	TRAY WITH CAP	TUBE WITHOUT CAP	TUBE WITH CAP	TAPE & REEL WITHOUT CAP	TAPE & REEL WITH CAP				A	B	F	M
-----	-----	87898-3161	-----	-----	-----	31	----	1	78.74	76.20	11.94	8.13
-----	-----	87898-3162	-----	-----	-----	31	----	2	78.74	76.20	11.94	8.13
-----	-----	87898-3164	-----	-----	-----	31	----	4	78.74	76.20	11.94	8.13
-----	-----	87898-3165	-----	-----	-----	31	----	5	78.74	76.20	11.94	8.13
-----	-----	87898-3166	-----	-----	-----	31	----	6	78.74	76.20	11.94	8.13
-----	-----	87898-3261	-----	-----	-----	32	----	1	81.28	78.74	11.94	8.13
-----	-----	87898-3262	-----	-----	-----	32	----	2	81.28	78.74	11.94	8.13
-----	-----	87898-3264	-----	-----	-----	32	----	4	81.28	78.74	11.94	8.13
-----	-----	87898-3265	-----	-----	-----	32	----	5	81.28	78.74	11.94	8.13
-----	-----	87898-3266	-----	-----	-----	32	----	6	81.28	78.74	11.94	8.13
-----	-----	87898-3361	-----	-----	-----	33	----	1	83.82	81.28	11.94	8.13
-----	-----	87898-3362	-----	-----	-----	33	----	2	83.82	81.28	11.94	8.13
-----	-----	87898-3364	-----	-----	-----	33	----	4	83.82	81.28	11.94	8.13
-----	-----	87898-3365	-----	-----	-----	33	----	5	83.82	81.28	11.94	8.13
-----	-----	87898-3366	-----	-----	-----	33	----	6	83.82	81.28	11.94	8.13

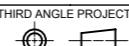
THIS DRAWING CONTAINS INFORMATION THAT IS PROPRIETARY TO MOLEX ELECTRONIC TECHNOLOGIES, LLC AND SHOULD NOT BE USED WITHOUT WRITTEN PERMISSION												
DIMENSION UNITS		SCALE		CURRENT REV DESC:								
mm		NTS										
GENERAL TOLERANCES (UNLESS SPECIFIED)				EC NO: 698212 DRWN: DANUSA 2022/03/03 CHK'D: DANUSA 2022/03/04 APPR: MRAMAKRISHNA 2022/03/04				CUSTOM HEADER 2.54MM PITCH SINGLE ROW SINGLE WAFER SMT HEADER				
		MM	INCH									
4 PLACES	±		±	INITIAL REVISION: DRWN: SKLIM01 2005/10/26 APPR: PTLIM 2005/11/07				DOCUMENT NUMBER		DOC TYPE	DOC PART	REVISION
3 PLACES	±		±					SD-87898-003		PSD	001	C1
2 PLACES	±	0.2	±	DRAFT WHERE APPLICABLE MUST REMAIN WITHIN DIMENSIONS				MATERIAL NUMBER		CUSTOMER		SHEET NUMBER
1 PLACE	±		±					SEE TABLE		GENERAL MARKET		14 OF 17
0 PLACES	±		±	THIRD ANGLE PROJECTION		DRAWING	SERIES	CUSTOMER		SHEET NUMBER		
ANGULAR TOL ± 3.0°				A3-SIZE	87898	SEE TABLE		GENERAL MARKET		14 OF 17		

PACKAGING OPTION PART NO.						CKT SIZE	VOID POSITION	PLATING TYPE	DIMENSION			
TRAY WITHOUT CAP	TRAY WITH CAP	TUBE WITHOUT CAP	TUBE WITH CAP	TAPE & REEL WITHOUT CAP	TAPE & REEL WITH CAP				A	B	F	M
-----	-----	87898-3461	-----	-----	-----	34	----	1	86.36	83.82	11.94	8.13
-----	-----	87898-3462	-----	-----	-----	34	----	2	86.36	83.82	11.94	8.13
-----	-----	87898-3464	-----	-----	-----	34	----	4	86.36	83.82	11.94	8.13
-----	-----	87898-3465	-----	-----	-----	34	----	5	86.36	83.82	11.94	8.13
-----	-----	87898-3466	-----	-----	-----	34	----	6	86.36	83.82	11.94	8.13
-----	-----	87898-3561	-----	-----	-----	35	----	1	88.90	86.36	11.94	8.13
-----	-----	87898-3562	-----	-----	-----	35	----	2	88.90	86.36	11.94	8.13
-----	-----	87898-3564	-----	-----	-----	35	----	4	88.90	86.36	11.94	8.13
-----	-----	87898-3565	-----	-----	-----	35	----	5	88.90	86.36	11.94	8.13
-----	-----	87898-3566	-----	-----	-----	35	----	6	88.90	86.36	11.94	8.13
-----	-----	87898-3661	-----	-----	-----	36	----	1	91.44	88.90	11.94	8.13
-----	-----	87898-3662	-----	-----	-----	36	----	2	91.44	88.90	11.94	8.13
-----	-----	87898-3664	-----	-----	-----	36	----	4	91.44	88.90	11.94	8.13
-----	-----	87898-3665	-----	-----	-----	36	----	5	91.44	88.90	11.94	8.13
-----	-----	87898-3666	-----	-----	-----	36	----	6	91.44	88.90	11.94	8.13

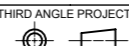
THIS DRAWING CONTAINS INFORMATION THAT IS PROPRIETARY TO MOLEX ELECTRONIC TECHNOLOGIES, LLC AND SHOULD NOT BE USED WITHOUT WRITTEN PERMISSION												
DIMENSION UNITS		SCALE		CURRENT REV DESC:								
mm		NTS										
GENERAL TOLERANCES (UNLESS SPECIFIED)				EC NO: 698212 DRWN: DANUSA 2022/03/03 CHK'D: DANUSA 2022/03/04 APPR: MRAMAKRISHNA 2022/03/04				CUSTOM HEADER 2.54MM PITCH SINGLE ROW SINGLE WAFER SMT HEADER				
		MM	INCH									
4 PLACES	±		±	INITIAL REVISION: DRWN: SKLIM01 2005/10/26 APPR: PTLIM 2005/11/07				DOCUMENT NUMBER		DOC TYPE	DOC PART	REVISION
3 PLACES	±		±					SD-87898-003		PSD	001	C1
2 PLACES	±	0.2	±	DRAFT WHERE APPLICABLE MUST REMAIN WITHIN DIMENSIONS				MATERIAL NUMBER		CUSTOMER		SHEET NUMBER
1 PLACE	±		±					SEE TABLE		GENERAL MARKET		15 OF 17
0 PLACES	±		±	THIRD ANGLE PROJECTION 		DRAWING	SERIES					
ANGULAR TOL		± 3.0°		A3-SIZE		87898						

PACKAGING OPTION PART NO.						CKT SIZE	VOID POSITION	PLATING TYPE	DIMENSION			
TRAY WITHOUT CAP	TRAY WITH CAP	TUBE WITHOUT CAP	TUBE WITH CAP	TAPE & REEL WITHOUT CAP	TAPE & REEL WITH CAP				A	B	F	M
-----	-----	87898-3761	-----	-----	-----	37	----	1	93.98	91.44	11.94	8.13
-----	-----	87898-3762	-----	-----	-----	37	----	2	93.98	91.44	11.94	8.13
-----	-----	87898-3764	-----	-----	-----	37	----	4	93.98	91.44	11.94	8.13
-----	-----	87898-3765	-----	-----	-----	37	----	5	93.98	91.44	11.94	8.13
-----	-----	87898-3766	-----	-----	-----	37	----	6	93.98	91.44	11.94	8.13
-----	-----	87898-3861	-----	-----	-----	38	----	1	96.52	93.98	11.94	8.13
-----	-----	87898-3862	-----	-----	-----	38	----	2	96.52	93.98	11.94	8.13
-----	-----	87898-3864	-----	-----	-----	38	----	4	96.52	93.98	11.94	8.13
-----	-----	87898-3865	-----	-----	-----	38	----	5	96.52	93.98	11.94	8.13
-----	-----	87898-3866	-----	-----	-----	38	----	6	96.52	93.98	11.94	8.13
-----	-----	87898-3961	-----	-----	-----	39	----	1	99.06	96.52	11.94	8.13
-----	-----	87898-3962	-----	-----	-----	39	----	2	99.06	96.52	11.94	8.13
-----	-----	87898-3964	-----	-----	-----	39	----	4	99.06	96.52	11.94	8.13
-----	-----	87898-3965	-----	-----	-----	39	----	5	99.06	96.52	11.94	8.13
-----	-----	87898-3966	-----	-----	-----	39	----	6	99.06	96.52	11.94	8.13

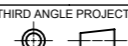
THIS DRAWING CONTAINS INFORMATION THAT IS PROPRIETARY TO MOLEX ELECTRONIC TECHNOLOGIES, LLC AND SHOULD NOT BE USED WITHOUT WRITTEN PERMISSION												
DIMENSION UNITS		SCALE		CURRENT REV DESC:								
mm		NTS										
GENERAL TOLERANCES (UNLESS SPECIFIED)				EC NO: 698212 DRWN: DANUSA 2022/03/03 CHK'D: DANUSA 2022/03/04 APPR: MRAMAKRISHNA 2022/03/04				CUSTOM HEADER 2.54MM PITCH SINGLE ROW SINGLE WAFER SMT HEADER				
		MM	INCH									
4 PLACES	±		±	INITIAL REVISION: DRWN: SKLIM01 2005/10/26 APPR: PTLIM 2005/11/07				DOCUMENT NUMBER		DOC TYPE	DOC PART	REVISION
3 PLACES	±		±					SD-87898-003		PSD	001	C1
2 PLACES	±	0.2	±	DRAFT WHERE APPLICABLE MUST REMAIN WITHIN DIMENSIONS				MATERIAL NUMBER		CUSTOMER		SHEET NUMBER
1 PLACE	±		±					SEE TABLE		GENERAL MARKET		16 OF 17
0 PLACES	±		±	THIRD ANGLE PROJECTION		DRAWING	SERIES	CUSTOMER		SHEET NUMBER		
ANGULAR TOL ± 3.0°				A3-SIZE	87898	SEE TABLE		GENERAL MARKET		16 OF 17		

PACKAGING OPTION PART NO.						CKT SIZE	VOID POSITION	PLATING TYPE	DIMENSION			
TRAY WITHOUT CAP	TRAY WITH CAP	TUBE WITHOUT CAP	TUBE WITH CAP	TAPE & REEL WITHOUT CAP	TAPE & REEL WITH CAP				A	B	F	M
-----	-----	87898-4061	-----	-----	-----	40	----	1	101.6	99.06	11.94	8.13
-----	-----	87898-4062	-----	-----	-----	40	----	2	101.6	99.06	11.94	8.13
-----	-----	87898-4064	-----	-----	-----	40	----	4	101.6	99.06	11.94	8.13
-----	-----	87898-4065	-----	-----	-----	40	----	5	101.6	99.06	11.94	8.13
-----	-----	87898-4066	-----	-----	-----	40	----	6	101.6	99.06	11.94	8.13

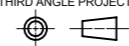
THIS DRAWING CONTAINS INFORMATION THAT IS PROPRIETARY TO MOLEX ELECTRONIC TECHNOLOGIES, LLC AND SHOULD NOT BE USED WITHOUT WRITTEN PERMISSION											
DIMENSION UNITS		SCALE		CURRENT REV DESC:							
mm		NTS									
GENERAL TOLERANCES (UNLESS SPECIFIED)				EC NO: 698212		DRWN: DANUSA		2022/03/03		CUSTOM HEADER 2.54MM PITCH SINGLE ROW SINGLE WAFER SMT HEADER	
				CHK'D: DANUSA		2022/03/04					
				APPR: MRAMAKRISHNA		2022/03/04		PRODUCT CUSTOMER DRAWING			
				INITIAL REVISION:		DRWN: SKLIM01		2005/10/26		DOCUMENT NUMBER	
				APPR: PTLIM		2005/11/07		SD-87898-003		DOC TYPE DOC PART REVISION	
				ANGULAR TOL ± 3.0°						PSD 001 C1	
DRAFT WHERE APPLICABLE MUST REMAIN WITHIN DIMENSIONS				THIRD ANGLE PROJECTION		DRAWING		SERIES		MATERIAL NUMBER	
						A3-SIZE		87898		CUSTOMER	
								SEE TABLE		GENERAL MARKET	
										SHEET NUMBER	
										17 OF 17	