

MFS1S50-H005E-C

Mellanox® MFS1S50-H005E Compatible TAA Compliant 200G-AOC QSFP56 to 2xQSFP56 Infiniband HDR Active Optical Cable (850nm, MMF, 5m, LSZH)

Features

- Low latency DSP-free electronics-based CDR
- Multi-data rate up to 56.15 Gb/s per lane
- PAM4 modulation
- Single 3.3 V power supply
- Low power consumption: 3.6W on 200G end with all CDRs enabled
- Up to 5m length
- SFF-8665 compliant
- SFF-8636 compliant I2C management interface
- Operating case temperature: 0°C to 70°C
- Hot pluggable
- RoHS/REACH compliant
- TUV-certified
- LSZH, Aqua cable



Application

- IEEE 802.3cd 200GBASE SR4
- IBTA InfiniBand HDR
- Datacenter: servers, switches, storages and NIC adapters
- Proprietary HPC interconnections

Product Description

This is a Mellanox® MFS1S50-H005E compatible 200GBase-AOC QSFP56 to 2xQSFP56 active optical cable that operates over multi-mode fiber with a maximum reach of 5.0m (16.4ft). At a wavelength of 850nm, it has been programmed, uniquely serialized, and data-traffic and application tested to ensure it is 100% compliant and functional. This active optical cable is TAA (Trade Agreements Act) compliant, and is built to comply with MSA (Multi-Source Agreement) standards. We stand behind the quality of our products and proudly offer a limited lifetime warranty.

ProLabs' active optical cables are RoHS compliant and lead-free.

TAA refers to the Trade Agreements Act (19 U.S.C. & 2501-2581), which is intended to foster fair and open international trade. TAA requires that the U.S. Government may acquire only "U.S. – made or designated country end products."



Absolute Maximum Ratings

Parameter	Symbol	Min	Typ.	Max.	Unit
Supply Voltage	V _{in}	0		4.0	V
Input Swing	V _{in-max}			1500	mVpp
Storage Temperature (Ambient)	T _{stc}	-40		85	°C
Relative Humidity	RH	5		85	%

Recommended Operating Specifications

Parameter	Symbol	Min	Typ.	Max.	Unit	Notes
Operating Case Temperature	T _{op}	0		70	°C	
Power Supply Voltage	V _{cc}	3.15	3.30	3.47	V	
Power Supply Current	200G End	I _{CC}	1100	1250	mA	1
	100G End	I _{CC}	750		mA	1
Power Consumption	200G End	P	3.6	4.0	W	1
	100G End	P	2.3	2.5	W	1

Notes:

1. Per end, all channel CDRs are enabled.

Electrical Characteristics

Parameter	Symbol	Min	Typ	Max	Unit	Notes
Data Rate (Per Channel)	BR		26.5625		GBd	1
Transmitter						
Input Differential Impedance	R _{IN}		100		Ω	
Differential Data Input Swing	V _{INP-P}	300		900	mV	
Receiver						
Output Differential Impedance	R _{OUT}		100		Ω	
Differential Data Output Swing	V _{OUTP-P}	300	700	900	mV	
Bit Error Ratio (at 26.5625 GBd)				2.4×10 ⁻⁴		2

Notes:

1. Dual data rate of 25.78125 and 28.07618 Gbaud are available upon request.
2. Pre-FEC Bit Error Ratio with a PRBS 2³¹ – 1 test pattern over a normal operating temperature range.

Active Optical Cable Specifications

Parameter	Value	Unit	Note
Cable Diameter	LSZH: $\varnothing 3.0 \pm 0.15$	mm	
Minimum Bend Radius	30	mm	Without tension
Length Tolerance	+300 / -0	mm	
Cable Jacket	LSZH, Aqua		

Electrical Pin-Out Details

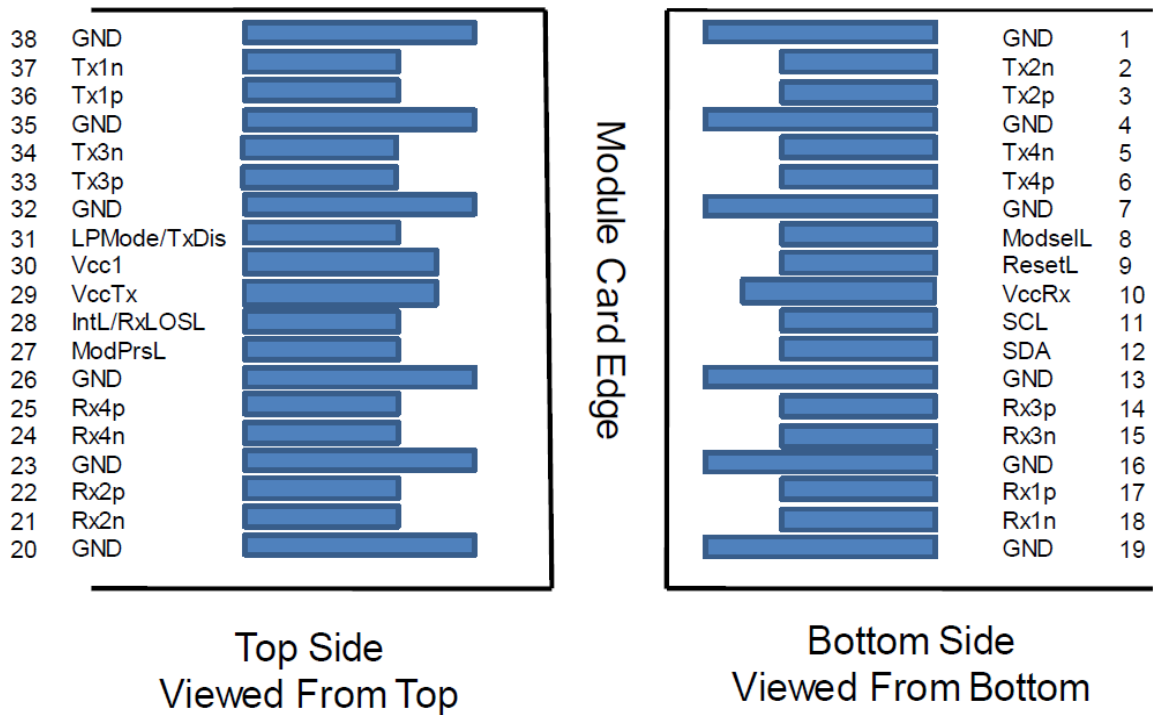

Pin Descriptions

Pin	Logic	Symbol	Description	Notes
1		GND	Ground	1
2	CML-I	Tx2n	Transmitter Inverted Data Input	
3	CML-I	Tx2p	Transmitter Non-Inverted Data Input	
4		GND	Ground	1
5	CML-I	Tx4n	Transmitter Inverted Data Input	
6	CML-I	Tx4p	Transmitter Non-Inverted Data Input	
7		GND	Ground	1
8	LVTTTL-I	ModSelL	Module Select	
9	LVTTTL-I	ResetL	Module Reset	
10		Vcc Rx	+3.3V Power supply receiver	2
11	LVC MOS-I/O	SCL	2-wire serial interface clock	
12	LVC MOS-I/O	SDA	2-wire serial interface data	
13		GND	Ground	1
14	CML-O	Rx3p	Receiver Non-Inverted Data Output	
15	CML-O	Rx3n	Receiver Inverted Data Output	
16		GND	Ground	1
17	CML-O	Rx1p	Receiver Non-Inverted Data Output	
18	CML-O	Rx1n	Receiver Inverted Data Output	
19		GND	Ground	1
20		GND	Ground	1
21	CML-O	Rx2n	Receiver Inverted Data Output	
22	CML-O	Rx2p	Receiver Non-Inverted Data Output	
23		GND	Ground	1
24	CML-O	Rx4n	Receiver Inverted Data Output	
25	CML-O	Rx4p	Receiver Non-Inverted Data Output	
26		GND	Ground	1
27	LVTTTL-O	ModPrsL	Module Present	
28	LVTTTL-O	IntL	Interrupt	
29		Vcc Tx	+3.3V Power supply transmitter	2
30		Vcc 1	+3.3V Power Supply	2
31	LVTTTL-I	LPMode	Low Power Mode	
32		GND	Ground	1
33	CML-I	Tx3p	Transmitter Non-Inverted Data Input	
34	CML-I	Tx3n	Transmitter Inverted Data Input	

35		GND	Ground	1
36	CML-I	Tx1p	Transmitter Non-Inverted Data Input	
37	CML-I	Tx1n	Transmitter Inverted Data Input	
38		GND	Ground	1

Note:

1. GND is the symbol for signal and supply (power) common for the QSFP module. All are common within the QSFP module and all module voltages are referenced to this potential unless otherwise noted. Connect these directly to the host board signal-common ground plane.
2. Vcc Rx, Vcc1 and Vcc Tx are the receiver and transmitter power supplies and shall be applied concurrently. Vcc Rx, Vcc1 and Vcc Tx may be internally connected within the QSFP transceiver module in any combination. The connector pins are each rated for a maximum current of 500 mA.

Block Diagram

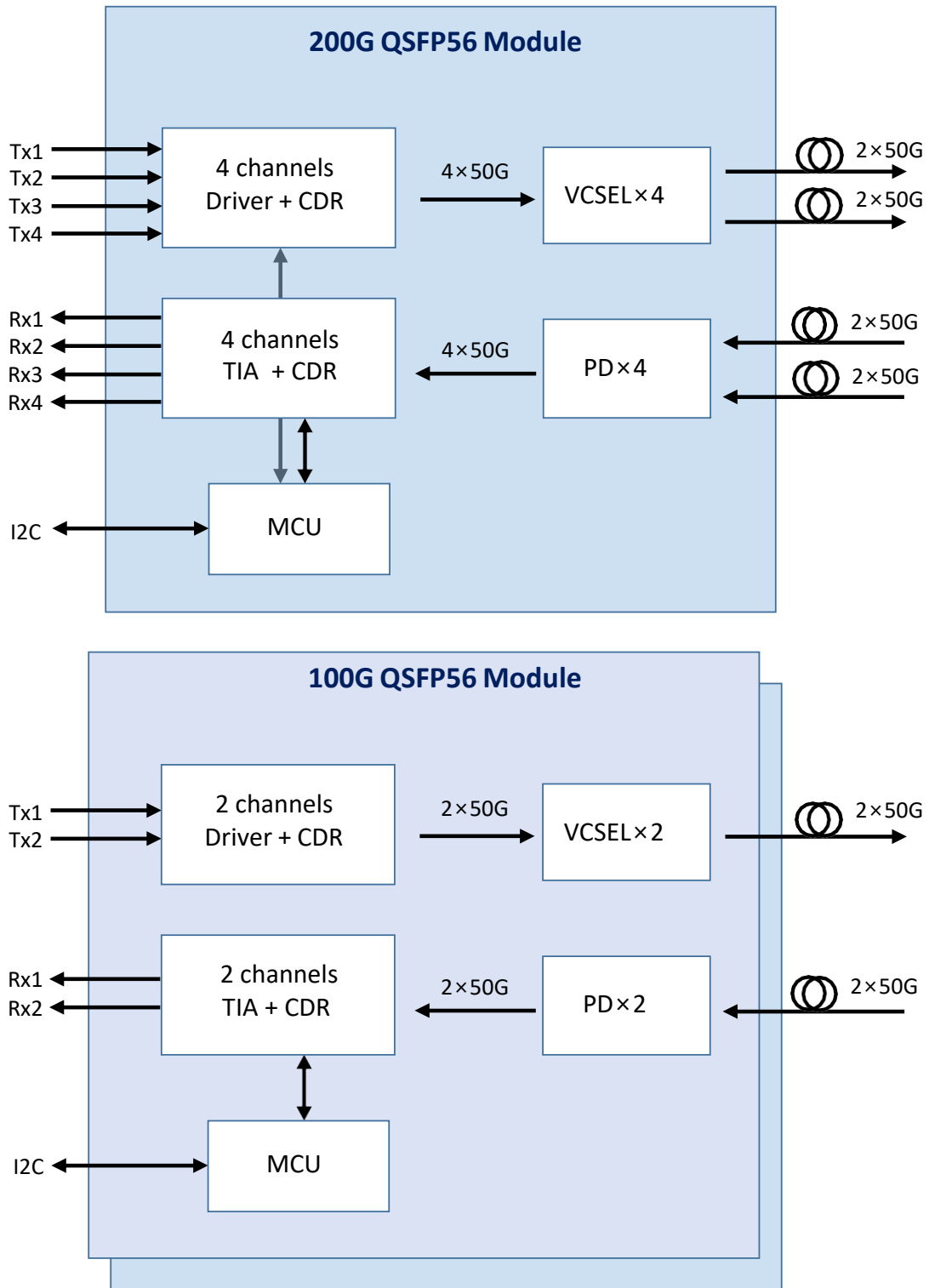

Mechanical Specification

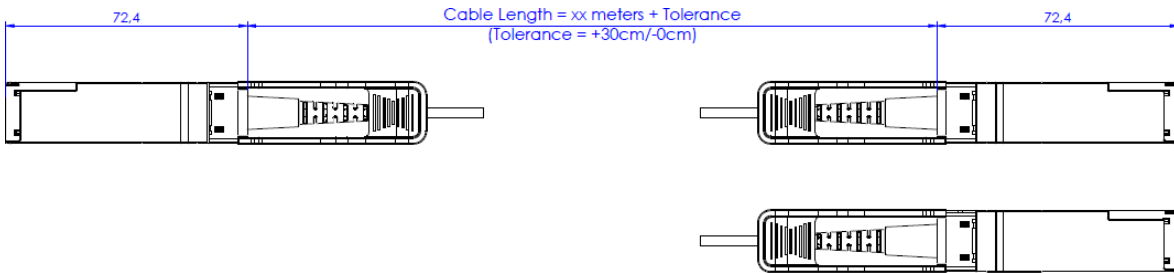
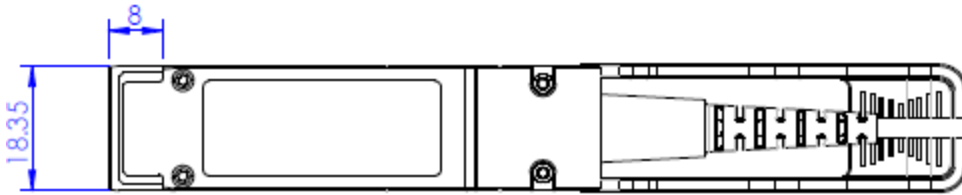
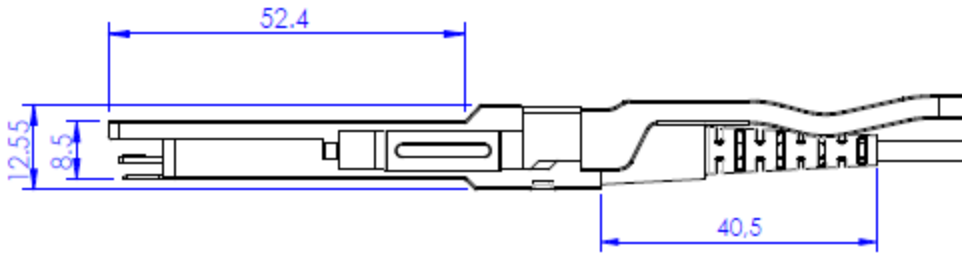
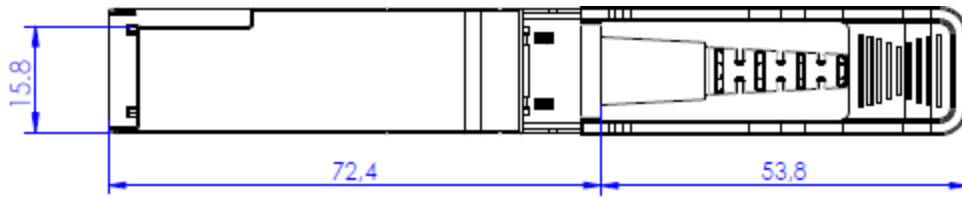

About ProLabs

Our experience comes as standard; for over 15 years ProLabs has delivered optical connectivity solutions that give our customers freedom and choice through our ability to provide seamless interoperability. At the heart of our company is the ability to provide state-of-the-art optical transport and connectivity solutions that are compatible with over 90 optical switching and transport platforms.

Complete Portfolio of Network Solutions

ProLabs is focused on innovations in optical transport and connectivity. The combination of our knowledge of optics and networking equipment enables ProLabs to be your single source for optical transport and connectivity solutions from 100Mb to 400G while providing innovative solutions that increase network efficiency. We provide the optical connectivity expertise that is compatible with and enhances your switching and transport equipment.

Trusted Partner

Customer service is our number one value. ProLabs has invested in people, labs and manufacturing capacity to ensure that you get immediate answers to your questions and compatible product when needed. With Engineering and Manufacturing offices in the U.K. and U.S. augmented by field offices throughout the U.S., U.K. and Asia, ProLabs is able to be our customers best advocate 24 hours a day.

Contact Information

ProLabs US

Email: sales@prolabs.com

Telephone: 952-852-0252

ProLabs UK

Email: salessupport@prolabs.com

Telephone: +44 1285 719 600