



# **ChipProg Device Programmers**

## **User's Guide**

**ChipProg-481,  
ChipProg-G41,  
ChipProg-48,  
ChipProg-40,  
ChipProg-ISP**

# ChipProg Device Programmers

© 2015 Phytion, Inc. Microsystems and Development Tools

All rights reserved. No parts of this work may be reproduced in any form or by any means - graphic, electronic, or mechanical, including photocopying, recording, taping, or information storage and retrieval systems - without the written permission of the publisher.

Products that are referred to in this document may be either trademarks and/or registered trademarks of the respective owners. The publisher and the author make no claim to these trademarks.

While every precaution has been taken in the preparation of this document, the publisher and the author assume no responsibility for errors or omissions, or for damages resulting from the use of information contained in this document or from the use of programs and source code that may accompany it. In no event shall the publisher and the author be liable for any loss of profit or any other commercial damage caused or alleged to have been caused directly or indirectly by this document.

Printed: May 2015 in (wherever you are located)

# Table of Contents

Foreword	0
<b>Part I Introduction</b>	<b>9</b>
1 Terms and Definitions.....	9
2 System Requirements.....	11
<b>Part II ChipProg Family Brief Description</b>	<b>12</b>
1 ChipProg-481.....	14
Major features .....	15
Hardware characteristics .....	15
Software features .....	15
2 ChipProg-G41.....	16
Major features .....	17
Hardware characteristics .....	18
Software features .....	18
3 ChipProg-48.....	19
Major features .....	20
Hardware characteristics .....	20
Software features .....	20
4 ChipProg-40.....	21
Major features .....	22
Hardware characteristics .....	23
Software features .....	23
5 ChipProg-ISP.....	24
Major features .....	26
Hardware characteristics .....	27
Software features .....	27
<b>Part III Quick Start</b>	<b>29</b>
1 Installing the ChipProgUSB Software.....	29
2 Installing the USB Drivers.....	31
3 Hardware installation.....	31
ChipProg-481 .....	32
ChipProg-G41 .....	33
ChipProg-48 .....	33
ChipProg-40 .....	34
ChipProg-ISP .....	35
4 Getting Assistance.....	36
On-line Help .....	36
Technical Support .....	36
Contact Information .....	37
<b>Part IV ChipProg Control Options</b>	<b>37</b>
1 Graphical User Interface.....	38

<b>User Interface Overview .....</b>	<b>38</b>
<b>Toolbars .....</b>	<b>39</b>
<b>Menus .....</b>	<b>39</b>
The File Menu.....	40
Configuration Files .....	41
The View Menu.....	41
The Project Menu .....	42
The Project Options Dialog.....	42
The Open Project Dialog.....	43
Project Repository.....	43
The Configure Menu.....	44
The Select Device dialog.....	45
The Buffers dialog .....	45
The Buffer Configuration dialog.....	46
Main Buffer Layer.....	46
Buffer Layers .....	47
The Serialization, Checksum and Log dialog.....	47
General settings.....	48
Device Serialization.....	49
Checksum .....	50
Signature string .....	51
Custom Shadow Areas.....	51
Overlapping data specified in shadow areas.....	51
Log file .....	52
The Preferences dialog.....	53
The Environment dialog.....	55
Fonts .....	55
Colors .....	56
Mapping Hot Keys.....	57
Toolbar .....	57
Messages .....	58
Miscellaneous Settings .....	58
Configurating Editor Dialog.....	59
General Editor Settings .....	59
The Editor Key Mapping.....	61
The Edit Key Command Dialog.....	61
The Commands Menu.....	62
Calculator .....	62
The Script Menu.....	63
The Window Menu.....	64
The Help Menu.....	65
<b>Windows .....</b>	<b>65</b>
The Program Manager Window .....	65
The Program Manager tab.....	66
Auto Programming.....	67
The Options tab .....	68
Split data .....	69
The Statistics tab.....	70
The Device and Algorithm Parameters window .....	71
Buffer Dump Window .....	74
The 'Configuring a Buffer' dialog.....	75
The 'Buffer Setup' dialog.....	76
The 'Display from address' dialog.....	78
The 'Modify Data' dialog.....	78

The 'Memory Blocks' dialog.....	78
The 'Load File' dialog.....	80
File Formats .....	81
The 'Save File' dialog.....	82
The Device Information window .....	83
Phyton programming adapters.....	83
Adapters for in-system programming.....	85
The Console Window .....	86
Windows for Scripts.....	86
<b>Simplified User Interface .....</b>	<b>87</b>
Settings of Simplified User Interface.....	88
Operations with Simplified User Interface.....	91
<b>2 Operations with Projects.....</b>	<b>91</b>
<b>3 Command Line Control.....</b>	<b>92</b>
Command line options .....	94
<b>4 On-the-Fly Control.....</b>	<b>97</b>
On-the-Fly command line options .....	98
On-the-Fly utility return codes .....	102
On-the-Fly Control example .....	103
<b>5 Script Files.....</b>	<b>105</b>
<b>The Script Files Dialog .....</b>	<b>105</b>
<b>How to create and edit script files .....</b>	<b>107</b>
The Editor Window .....	108
Text Edit .....	109
The Search for Text Dialog.....	110
The Replace Text Dialog.....	111
The Confirm Replace Dialog.....	112
The Multi-File Search Results Dialog.....	113
Search for Regular Expressions .....	113
The Set/Retrieve Bookmark Dialogs.....	114
Condensed Mode.....	114
The Condensed Mode Setup Dialog.....	114
Automatic Word Completion.....	115
Syntax Highlighting.....	115
The Display from Line Number Dialog .....	116
The Quick Watch Function.....	116
Block Operations.....	116
<b>How to start and debug script files .....</b>	<b>117</b>
The AutoWatches Pane.....	119
The Watches Window .....	119
The Display Watches Options Dialog.....	120
The Add Watch Dialog.....	121
The User Window .....	121
The I/O Stream Window .....	122
<b>6 Programming Automation via DLL.....</b>	<b>123</b>
<b>Application Control Interface .....</b>	<b>123</b>
<b>ACI Functions .....</b>	<b>125</b>
ACI_Launch.....	128
ACI_Exit .....	128
ACI_LoadConfigFile.....	129
ACI_SaveConfigFile.....	129
ACI_SetDevice.....	129

ACI_GetDevice.....	130
ACI_GetLayer .....	130
ACI_CreateBuffer.....	130
ACI_ReallocBuffer.....	130
ACI_ReadLayer.....	131
ACI_WriteLayer.....	131
ACI_FillLayer.....	131
ACI_GetProgrammingParams.....	132
ACI_SetProgrammingParams.....	132
ACI_GetProgOption.....	132
ACI_SetProgOption.....	133
ACI_AllProgOptionsDefault.....	134
ACI_ExecFunction.....	134
ACI_StartFunction.....	134
ACI_GangStart.....	135
ACI_GetStatus .....	135
ACI_TerminateFunction.....	135
ACI_GangTerminateFunction.....	135
ACI_FileLoad.....	136
ACI_FileSave.....	136
ACI_SettingsDialog.....	136
ACI_SelectDeviceDialog.....	136
ACI_BuffersDialog.....	137
ACI_LoadFileDialog.....	137
ACI_SaveFileDialog.....	138
ACI_SetConnection.....	139
ACI_GetConnection.....	139
<b>ACI Structures .....</b>	<b>140</b>
ACI_Launch_Params .....	141
ACI_Config_Params.....	141
ACI_Device_Params.....	142
ACI_Layer_Params.....	142
ACI_Buffer_Params.....	143
ACI_Memory_Params.....	145
ACI_Programming_Params.....	146
ACI_ProgOption_Params.....	148
ACI_Function_Params.....	152
ACI_GangTerminate_Params.....	154
ACI_PStatus_Params.....	154
ACI_File_Params.....	156
ACI_GangStart_Params.....	157
ACI_Connection_Params.....	158
<b>Examples of use .....</b>	<b>158</b>
<b>7 Control from NI LabVIEW .....</b>	<b>160</b>
Command Line Control from LabVIEW .....	160
Control from LabVIEW with DLL .....	163
<b>Part V Operating with Programmers .....</b>	<b>166</b>
<b>1 Inserting devices to a programming socket.....</b>	<b>166</b>
<b>2 Auto-detecting the device .....</b>	<b>166</b>
<b>3 Basic programming functions.....</b>	<b>167</b>
How to check if a device is blank .....	167

<b>How to erase a device</b> .....	<b>167</b>
<b>How to program a device</b> .....	<b>167</b>
How to load a file into a buffer .....	168
How to edit information before programming .....	168
How to configure the chosen device .....	168
How to write information into the device .....	168
<b>How to read a device</b> .....	<b>169</b>
<b>How to verify programming</b> .....	<b>169</b>
<b>How to save data on a disc</b> .....	<b>169</b>
<b>How to duplicate a device</b> .....	<b>170</b>
<b>4 Programming NAND Flash memory</b> .....	<b>170</b>
<b>NAND Flash memory architectures</b> .....	<b>170</b>
Invalid blocks .....	172
Managing invalid blocks .....	172
Skipping invalid blocks .....	172
Reserved Block Area .....	172
Error Checking and Correction .....	173
Invalid block map .....	173
Marking invalid blocks .....	174
<b>Programming NAND Flash devices by ChipProg</b> .....	<b>175</b>
Access Mode .....	176
Invalid Block Management .....	176
Spare Area Usage .....	176
Guard Solid Area .....	177
Tolerant Verify Feature .....	178
Invalid Block Indication Option .....	178
Access Mode Parameters .....	178
User Area .....	179
Solid Area .....	179
Reserved Block Area .....	180
ECC Frame size .....	180
Acceptable number of errors .....	180
<b>5 Multi- and Gang-programming</b> .....	<b>181</b>
<b>The Program Manager Window</b> .....	<b>182</b>
The Program Manager tab .....	183
The Options tab .....	183
The Statistics tab .....	184
<b>6 In-System Programming</b> .....	<b>186</b>
<b>Part VI References</b> .....	<b>187</b>
<b>1 Errors Messages</b> .....	<b>187</b>
<b>Error Load/ Save File</b> .....	<b>187</b>
<b>Error Addresses</b> .....	<b>187</b>
<b>Error sizes</b> .....	<b>188</b>
<b>Error command-line option</b> .....	<b>188</b>
<b>Error Programming option</b> .....	<b>188</b>
<b>Error DLL</b> .....	<b>189</b>
<b>Error USB</b> .....	<b>189</b>
<b>Error programmer hardware</b> .....	<b>189</b>
<b>Error internal</b> .....	<b>190</b>
<b>Error configuration</b> .....	<b>190</b>
<b>Error device</b> .....	<b>190</b>

Error check box .....	190
Error mix .....	190
Warning .....	191
<b>2 Expressions.....</b>	<b>191</b>
Operations with Expressions .....	191
Numbers .....	193
Examples of Expressions .....	193
<b>3 Script Language.....</b>	<b>194</b>
Simple example .....	194
Description .....	195
Built-in Functions .....	195
Built-in Variables .....	196
Difference between the Script and the C Languages .....	197
Script Language Built-in Functions and Variables .....	198
<b>4 In-System Programming for different devices.....</b>	<b>206</b>
Specific of programming PICmicro .....	206
Specific of programming AVR microcontrollers .....	206
Specific of programming Atmel 8051 microcontrollers .....	207
 <b>Index</b>	 <b>208</b>



## 1 Introduction



# ChipProg Device Programmers

## User's Guide

ChipProg-481  
 ChipProg-G41  
 ChipProg-48  
 ChipProg-40  
 ChipProg-ISP

Copyright © 2005-2014, Phyton, Inc. Microsystems and Development Tools, All rights reserved

### 1.1 Terms and Definitions

#### Terms used in the document

<b>Target device</b> or <b>Target</b>	The device to be programmed by a programmer either in the programmer socket or by an additional adapter or by a cable for in-system programming.
<b>Start and End Addresses</b> (of the Target device)	A range of the device physical memory for the programming operations (Read, Write, Verify, etc.).
<b>Device package</b> or <b>Package</b>	Mechanical characteristics of the target device; ChipProg programmers enable operations on the devices packed in the DIP (DIL) packages with no additional adapters as well as on most non-DIP packed devices, including but not limited to the devices in the PLCC, SOIC, SSOP, TSOP, SSOP, QFP, BGA, QNF and other packages.
<b>Programming socket</b> or <b>Programming ZIF socket</b> or <b>ZIF socket</b>	A socket installed on a programmer unit or on an adapter (see below) to accommodate the target device for programming. All ChipProg models use ZIF (or Zero Insertion Force) programming sockets that allow for the temporary installation of the target device in the programmer site and easily removing it after completing the programming procedure. %CPN%>-40, ChipProg-48 and ChipProg-G41 are equipped with 40- and 48-pin ZIF

	sockets allowing operation on any DIP-packed devices with different numbers of leads and different widths and also connecting additional adapters for programming devices in other packages.
<b>Adapter or Package adapter</b>	A small transition board with dual-in-line rows of pins pluggable into the programmer ZIF socket on the bottom side and with a package-specific ZIF socket (TSOP, PLCC, etc.) on the top. The adapters for in-system programming by means of the parallel programmers are implemented as ribbon cables that connect to the target board via a special header. The adapter boards can carry passive components (ZIF sockets, pins and cables) and active components (drivers, latches, transistors, etc.). Hundreds of Phytion brand adapters as well as third party adapters are available to support devices in most types of mechanical packages.
<b>File</b>	In the ChipProg context the term <b>file</b> may represent: a) an image of information on a PC hard drive or other media that is supposed to be written into the target device's physical memory or b) an image read out from the target device and then stored on the disk or other media. Files in a ChipProg can be loaded from and saved on a PC hard drive or CD.
<b>Buffer or Memory buffer</b>	A memory segment, physically assigned from the computer operational memory (RAM), for temporarily storing, editing and displaying the data to be physically written to the target device's memory or read out from the device. The program allows opening an unlimited number of buffers of any size while it is not restricted by the computer memory.
<b>Buffer layer or sub-layer</b>	A buffer may have a few layers (in some topics also known as sub-layers) that are defined by a particular architecture and memory model of the target device. For example, for some microcontrollers one buffer can include the code and data memory layers (see more details below).
<b>Buffer size</b>	The buffers may have different sizes from 128KB to 32GB each.
<b>Buffer start address</b>	The address to display the buffer contents from.
<b>Checksum</b>	An arithmetic sum of the data located within a specified part of the buffer calculated by the programmer to control the data integrity. The program enables different algorithms for the checksum calculation and enables writing the checksum into a specified location of the target device.
<b>Parallel or In-socket programming</b>	Operations on a device being placed into the programmer's ZIF socket or into a programming adapter (opposite to the in-system programming below).
<b>ICP or in-circuit programming</b>	Programming devices mounted on the boards (in the user's equipment) via special adapter-cable connecting the programmer to the target.
<b>ISP or in-system programming</b>	Same as above. Programming devices mounted on the boards (in the user's equipment) via special adapter-cable connecting the programmer with the target.

<b>ISP Mode</b>	Mode of the in-system programming that is usually defined by the programming signals voltage or the ISP interface (JTAG, UART, SPI, etc.). Distinct ISP modes are enabled for different target devices and more than one mode may exist for one device.
<b>ISP JTAG Mode</b>	In-system programming via a JTAG interface.
<b>ISP HV Mode</b>	In-system programming that requires applying a relatively high voltage to the target device, (12V for example).
<b>Command Line mode</b>	A method of the ChipProg control by means of interacting with a computer program where the user issues commands to the program in the form of successive lines of text (command lines).
<b>Project</b>	An integrated set of information that completely describes the target device, properties of the data buffers, programming options and settings, list of the source and destination files with all their properties, etc.. Each project, that has its own unique name, can be stored and promptly reloaded for immediate execution. Usually a user creates a project to work with one type of device. Working with projects saves a lot of time for the initial configuration of the programmer every time you start working with a new device.

### File - Buffer - Target structure

Buffers are intermediate layers between the data in files and the data in the target device. The ChipProg enables no direct interaction between the files and target devices. All the file operations, such as loading and saving files are applicable to the buffers only. All the physical manipulations with the target device memory content pass through the buffers as well. This is a fundamental principle of the programmer operations with data and devices.

### Examples of the buffer's layer structures of different devices:

1. In the Intel 87C51FA microcontroller each opened buffer includes two layers: **Code** and **Encryption table**.
2. In the Microchip PIC16F84 microcontroller each opened buffer includes three layers: **Code**, **Data EEPROM** and **Identifier locations**.

Each buffer layer can be opened for watching or editing by clicking its tab on the top of the buffer window.

## 1.2 System Requirements

To run ChipProgUSB and to control a ChipProg device programmers, you need an IBM PC-compatible personal computer with the following components:

- Pentium-V CPU or higher
- At least one USB port
- A hard drive with at least 200MB of free space
- Microsoft Windows XP, Windows 7 and Windows 8 operating systems.

## 2 ChipProg Family Brief Description

ChipProg is a family of device programmers produced by Phyton, Inc. Microsystems and Development Tools (hereafter Phyton). A current ChipProg portfolio includes several device programmers that belong to the following functional groups:

### Universal parallel programmers for engineering and small volume manufacturing



[ChipProg-481](#), [ChipProg-48](#) and [ChipProg-40](#) single-site device programmers are intended for engineering and small volume manufacturing. These models allow operating on the devices before they are installed in the equipment (parallel programming or in-socket programming) as well as on the devices already installed in the user's equipment (the method known as [In-System Programming](#), that uses serial data transmission into the programmable device). [ChipProg-48](#) and [ChipProg-40](#) device programmers are controlled by the [ChipProgUSB](#) software, a newer [ChipProg-481](#) - by the [ChipProgUSB-01](#) software pack. Since both [ChipProgUSB](#) and [ChipProgUSB-01](#) models has the same [user interface](#), control tools, etc. this document operates with the [ChipProgUSB](#) term applicable to both software packages.

### Universal parallel gang programmers for manufacturing

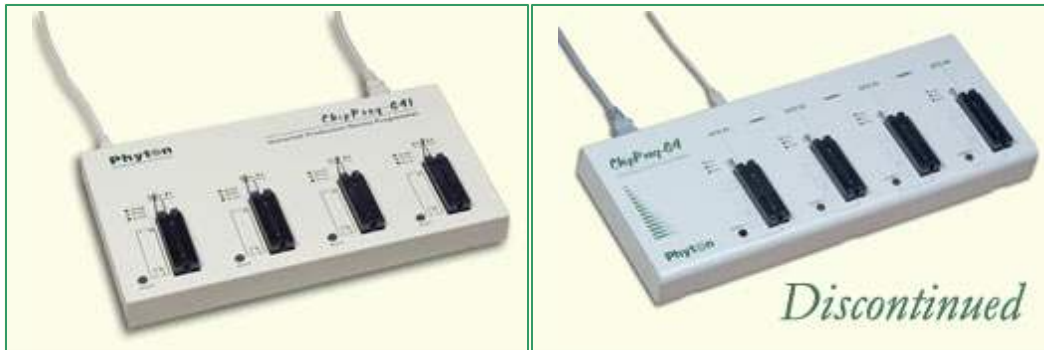

[ChipProg-G41](#) and [ChipProg-G4](#) (, discontinued in 2010-2011) four-site gang device programmers are intended for mass production. The , [ChipProg-G41](#) gang machine is based on four concurrently and independently running ChipProg-481 device programmers. The [ChipProg-481](#) is controlled by the [ChipProgUSB-01](#) software pack.

#### Universal in-system device programmers for engineering and manufacturing



The [ChipProg-ISP](#) is a low-cost device programmer for engineering, field service and manufacturing. Unlimited number of these device programmers can be driven from one PC and can run concurrently to program multiple devices at a time. This device programmer works under control of the [ChipProgUSB](#) software pack.

#### How to choose a right device programmer?

- [ChipProg-40](#): the least expensive Phytion device programmer, intended for working with a limited device list; it does not support PLDs.
- [ChipProg-48](#): truly universal yet inexpensive device programmer; may not be fast enough for NAND programming.
- [ChipProg-481](#): truly universal device programmer: extremely fast, targeted to NAND memory support.
- [ChipProg-G41](#): extremely fast 4-site device programmer for production; can be controlled remotely from ATE.
- [ChipProg-ISP](#): inexpensive in-system programmer; multiple ChipProg-ISPs can be driven in the gang mode.

See [also](#).

## 2.1 ChipProg-481

The **ChipProg-481** universal programmer can be effectively used for both engineering and low-volume manufacturing. It supports in-socket and in-system programming of thousand of devices and has no valuable limitations in supporting future devices. The unlimited future device support differs **ChipProg-481** from the simplified, much slower and less expensive **ChipProg-40** model. The ChipProg-481 is much faster than the ChipProg-48 model, especially on high density NAND and NOR flash memory devices (~15-20 times faster).



The programmer has a 48-pin DIP ZIF socket that enables inserting any wide or narrow DIP-packed devices with up to 48 leads without the necessity to use any additional adapters. Programming of other devices requires the use of additional adapters available from Phytion and a few selected vendors. The programmer has three LEDs for displaying the programming status (“Good”, “Busy”, “Error”) and the “Start” button for fast launch of the pre-programmed command chains. The palm-size programmer has a wall-plugged power adapter that is not shown on the picture above.

### **Standard package contents:**

- One programmer unit
- One power adapter 12V/1A+
- One USB link cable
- One CD with the ChipProgUSB-01 software

Optionally the package may include one or more programming adapters (if ordered with the programmer) and a “QuickStart” printed manual. See also for more details:

[Major features](#)

[Hardware characteristics](#)

[Software features](#)

### 2.1.1 Major features

1. Equipped with a 48 pin ZIF socket that allows insertion of the DIP-packed devices with the package width from 300 to 600 mil (7.62 to 15.24 mm) and the number of leads up to 48 without additional adapters.
2. Links to a PC USB 2.0 compatible port, e.g. slower USB connection is also supported.
3. Provides fast programming; for example, completely writes a 1Gb NAND K9F1G08U0A in 22 sec! (~640 sec by ChipProg-48)
4. Can program target devices in the programmer ZIF socket as well as the devices installed in the equipment (ISP mode).
5. An unlimited number of ChipProg-481 tools can be driven from multiple USB ports of one computer (or via a USB hub) to provide concurrent programming of multiple devices of the same type.
6. Has a button for fast manual launch of any single operation or a bunch of operations.
7. Has three LEDs for displaying the programming status (“Good”, “Busy”, “Error”).

### 2.1.2 Hardware characteristics

1. The programmer has a 48-pin ZIF socket with a lever that enables the insertion and clamping of any DIP-packed devices with the package width from 300 to 600 mil (7.62 to 15.24 mm) and with the number of leads up to 48.
2. Adapters for programming devices in the SDIP, PLCC, SOIC, SOP, PSOP, TSOP, TSOPII, TSSOP, QFP, TQFP, VQFP, QFN, SON, BGA, CSP and other packages are available from Phyton and selected third parties.
3. The programmer is built on the base of a very fast and productive 32-bit embedded microcontroller and a FPGA. These resources allow adding new targets to the device list by a simple software update.
4. Most timing-critical parts of the programming algorithms are implemented in the FPGA devices.
5. Implementation in the FPGA devices logical drivers enables outputting logical signals of any level (low, high, Pullup, Pulldown and external clock generator) to any pin of the programming ZIF socket.
6. The programmers's hardware features 10-bit digital-to-analog converters for accurate settings of the analog signals.
7. The programmers's hardware enables accurate programming of the rising and falling edges of the generated analog signals.
8. The programmers's hardware automatically adjusts the generated analog signals in accordance to the target device programming specifications.
9. The generated analog signals for both the target supplying and programming can be outputted to any pins of the device being programmed.
10. The programmers's can connect any pin of the device being programmed to the “Ground” level.
11. The programmers's hardware checks if every pin of the target device is reliably fixed by a ZIF socket's contacts (“bad contact” checking).
12. The programmers's hardware protects itself and the target device against incorrect insertions and other issues that cause a sharp increase in the currents through the target device circuits. This “over current” protection is very fast and reliable.
13. The target device's pins are protected against the electrostatic discharge.
14. The programmers's hardware has a programmable clock generator.
15. The self-testing procedure automatically executes at any time the programmer is powered on.

### 2.1.3 Software features

1. The ChipProgUSB-01 software works under control of Windows XP, 7 (32- and 64-bit), 8.
2. Several methods of control are available: friendly and intuitive [Graphic User Interface](#) (GUI), [Command Line](#) control, Remote Control via the [Application Control Interface](#) (the DLL), [on-the-fly control](#) are

included into the standard ChipProgUSB package.

3. Includes a set of basic commands: Blank Check, Erase, Read, Write, Verify, Lock, Set Configuration Bits, Data Memory Support, etc., executed by a single mouse click.
4. Enables presetting a batch of the commands above executed one after one either by a manual start or by a mouse click or automatically upon the device insertion into the programming socket.
5. Allows serialization of the programming devices with auto incrementing the device numbers and storing a serialization log (in the Auto Programming mode only).
6. The program can calculate checksums of the selected data array and then write the checksum into a specified memory location of the target device (in the Auto Programming mode only). Several methods of the checksum calculation can be used.
7. The program allows writing a unique signature into a specified memory location of the target device for the device identification (in the Auto Programming mode only).
8. The project support speeds up and simplifies switching between different programming tasks.
9. The software allows pre-programming a particular operation (or a chain of operations), which is supposed to be automatically triggered when the programmer hardware detects insertion of the target device into the programming socket.
10. An unlimited number of memory buffers can be opened in the main ChipProgUSB-01 window.
11. The software supports a multiple programming mode for concurrent programming of the same type of target devices on the same type of programmers connected to one computer. A number of single device programmers connected to the programming cluster does not slow down the programming speed.
12. The software includes a full-scale binary editor allowing manual modification of the data in buffers as well as such helpful functions as Search and Replace, Fill, Compare, Copy, Invert, Calculate Checksum, and OR, AND, XOR logical operations on the blocks of data.
13. Loading and saving files in several standard and proprietary formats: Binary, Standard Extended Intel HEX, Motorola S-record, POF, JEDEC, PRG, Holtek OTP, ASCII HEC, ASCII OCTAL, Angstrom SAV. Special non-standard formats can be added upon request.
14. The software is featured by a script language and a mechanism of handling the script scenarios for automation of the routine operations and chip replications.

## 2.2 ChipProg-G41

The **ChipProg-G41** is a 4-site gang programmer based on four **ChipProg-481** programming modules enclosed in one case and driven from the ChipProgUSB-01 software. It is intended for middle- and low-volume manufacturing. It supports in-socket and in-system programming of thousand of devices and has no valuable limitations for supporting future devices.

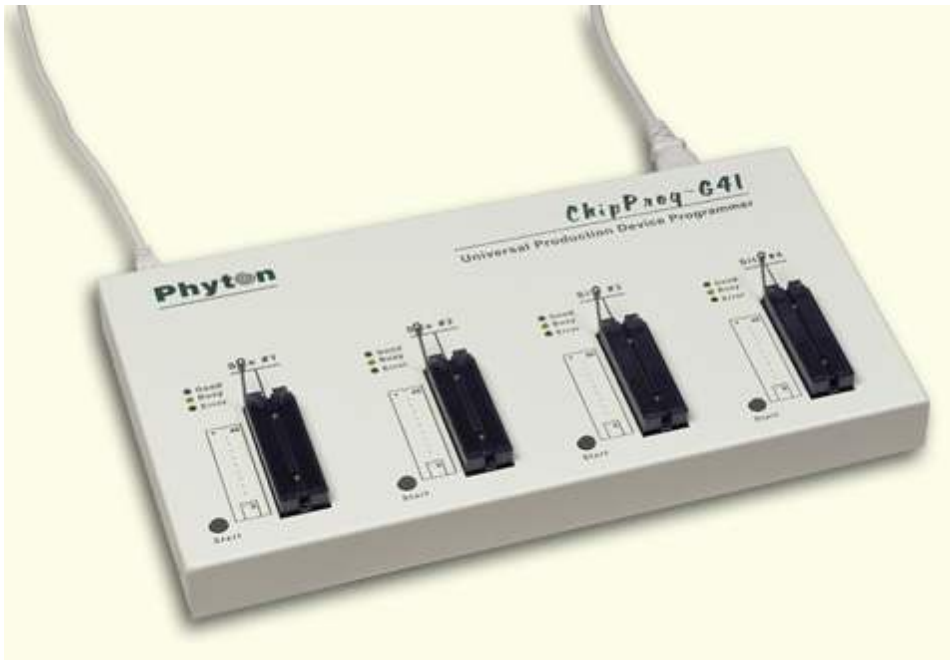

**Standard package contents:**

- One programmer unit
- One power cable
- One USB link cable
- One CD with the ChipProgUSB-01 software

Optionally the package may include one or more programming adapters (if ordered with the programmer) and a “QuickStart” printed manual. See also for more details:

[Major features](#)[Hardware characteristics](#)[Software features](#)

## 2.2.1 Major features

1. Based on four ChipProg-481 programming modules enclosed in a metal case and connected to a PC via an embedded USB hub.
2. Allows independent and concurrent programming of up to four devices of the same type.
3. A few ChipProg-G41 units can be cascaded to allow programming on 8-, 12-, 16- and more sites concurrently.
4. 48 pin ZIF sockets allow insertion of any DIP-packed devices with the package width from 300 to 600 mil (7.62 to 15.24 mm) and the number of leads up to 48 without additional adapters.
5. Links to a PC USB 2.0 compatible port via one link cable.
6. Provides fast programming; for example, completely writes a 1Gb NAND K9F1G08U0A flash device in 22 sec!
7. Can program target devices in its socket as well as devices installed in the equipment (ISP mode).
8. Each programming site has a 'Start' button for fast manual launch of any single operation or a batch of operations.
9. Each programming site has three LEDs for displaying the programming status (“Good”, “Busy”, “Error”).

## 2.2.2 Hardware characteristics

1. Enclosed in a durable steel case to be used in an industrial environment.
2. The tool gets power from a standard outlet 110-240V, 50-60 Hz.
3. Each programming site based on a single ChipProg-481 programmer has a 48-pin ZIF socket with a lever that enables the insertion and clamping of any DIP-packed devices with the package width from 300 to 600 mil (7.62 to 15.24 mm) and with the number of leads up to 48.
4. Adapters for programming devices in the SDIP, PLCC, SOIC, SOP, PSOP, TSOP, TSOPII, TSSOP, QFP, TQFP, VQFP, QFN, SON, BGA, CSP and other packages are available from Phytion and many third parties.
5. Single ChipProg-481 programmers inside of the tool enclosure are connected to an embedded USB 2.0 hub
6. Each programming site is built on the base of a very fast and powerful 32-bit embedded microcontroller and FPGA. These resources allow adding new targets to the device list by a simple software update.

## 2.2.3 Software features

1. The ChipProgUSB-01 software works under control of Windows XP, 7 (32- and 64-bit), 8.
2. Several methods of control are available: friendly and intuitive [Graphic User Interface \(GUI\)](#), [Command Line](#) control, Remote Control via the [Application Control Interface](#) (the DLL), [on-the-fly control](#) are included into the standard ChipProgUSB package.
3. Includes a set of basic commands: Blank Check, Erase, Read, Write, Verify, Lock, Set Configuration Bits, Data Memory Support, etc., executed by a single mouse click.
4. Enables presetting a batch of the commands above executed one after one either by a manual start or by a mouse click or automatically upon the device insertion into the programming socket.
5. Allows serialization of the programming devices with auto incrementing the device numbers and storing a serialization log (in the Auto Programming mode only).
6. The program can calculate checksums of the selected data array and then write the checksum into a specified memory location of the target device (in the Auto Programming mode only). Several methods of the checksum calculation can be used.
7. The program allows writing a unique signature into a specified memory location of the target device for the device identification (in the Auto Programming mode only).
8. The project support speeds up and simplifies switching between different programming tasks.
9. The software allows pre-programming a particular operation (or a chain of operations), which is supposed to be automatically triggered when the programmer hardware detects insertion of the target device into the programming socket.
10. An unlimited number of memory buffers can be opened in the main ChipProgUSB-01 window.
11. The software supports a multiple programming mode for concurrent programming of the same type of target devices on the same type of programmers connected to one computer. A number of single device programmers connected to the programming cluster does not slow down the programming speed.
12. The software includes a full-scale binary editor allowing manual modification of the data in buffers as well as such helpful functions as Search and Replace, Fill, Compare, Copy, Invert, Calculate Checksum, and OR, AND, XOR logical operations on the blocks of data.
13. Loading and saving files in several standard and proprietary formats: Binary, Standard Extended Intel HEX, Motorola S-record, POF, JEDEC, PRG, Holtek OTP, ASCII HEC, ASCII OCTAL, Angstrom SAV. Special non-standard formats can be added upon request.
14. The software is featured by a script language and a mechanism of handling the script scenarios for automation of the routine operations and chip replications.

## 2.3 ChipProg-48

The **ChipProg-48** universal programmer can be effectively used for both engineering and low-volume manufacturing. It supports in-socket and in-system programming of thousand of devices and has no valuable limitations in supporting future devices. The unlimited future device support differs **ChipProg-48** from the simplified and less expensive **ChipProg-40** model.



The programmer has a 48-pin DIP ZIF socket that enables inserting any wide or narrow DIP-packed devices with up to 48 leads without the necessity to use any additional adapters. Programming of other devices requires the use of additional adapters available from Phyton and a few selected vendors. The programmer has three LEDs for displaying the programming status (“Good”, “Busy”, “Error”) and the “Start” button for fast launch of the pre-programmed command chains. The palm-size programmer has a wall-plugged power adapter that is not shown on the picture above.

### **Standard package contents:**

- One programmer unit
- One power adapter 12V/1A+
- One USB link cable
- One CD with the ChipProgUSB software

Optionally the package may include one or more programming adapters (if ordered with the programmer) and a “QuickStart” printed manual. See also for more details:

[Major features](#)

[Hardware characteristics](#)

[Software features](#)

### 2.3.1 Major features

1. Equipped with a 48 pin ZIF socket that allows insertion of the DIP-packed devices with the package width from 300 to 600 mil (7.62 to 15.24 mm) and the number of leads up to 48 without additional adapters.
2. Links to a PC USB 2.0 compatible port, e.g. slower USB connection is also supported.
3. Provides fast programming; for example, completely writes a 64M bit NOR FLASH in less than 50 sec.
4. Can program target devices in the programmer ZIF socket as well as the devices installed in the equipment (ISP mode).
5. An unlimited number of ChipProg-48 tools can be driven from multiple USB ports of one computer (or via a USB hub) to provide concurrent programming of multiple devices of the same type.
6. Has a button for fast manual launch of any single operation or a bunch of operations.
7. Has three LEDs for displaying the programming status (“Good”, “Busy”, “Error”).

### 2.3.2 Hardware characteristics

1. The programmer has a 48-pin ZIF socket with a lever that enables the insertion and clamping of any DIP-packed devices with the package width from 300 to 600 mil (7.62 to 15.24 mm) and with the number of leads up to 48.
2. Adapters for programming devices in the SDIP, PLCC, SOIC, SOP, PSOP, TSOP, TSOPII, TSSOP, QFP, TQFP, VQFP, QFN, SON, BGA, CSP and other packages are available from Phytion and selected third parties.
3. The programmer is built on the base of a very fast and productive 32-bit embedded microcontroller and a FPGA. These resources allow adding new targets to the device list by a simple software update.
4. Most timing-critical parts of the programming algorithms are implemented in the FPGA devices.
5. Implementation in the FPGA devices logical drivers enables outputting logical signals of any level (low, high, Pullup, Pulldown and external clock generator) to any pin of the programming ZIF socket.
6. The programmers's hardware features 10-bit digital-to-analog converters for accurate settings of the analog signals.
7. The programmers's hardware enables accurate programming of the rising and falling edges of the generated analog signals.
8. The programmers's hardware automatically adjusts the generated analog signals in accordance to the target device programming specifications.
9. The generated analog signals for both the target supplying and programming can be outputted to any pins of the device being programmed.
10. The programmers's can connect any pin of the device being programmed to the “Ground” level.
11. The programmers's hardware checks if every pin of the target device is reliably fixed by a ZIF socket's contacts (“bad contact” checking).
12. The programmers's hardware protects itself and the target device against incorrect insertions and other issues that cause a sharp increase in the currents through the target device circuits. This “over current” protection is very fast and reliable.
13. The target device's pins are protected against the electrostatic discharge.
14. The programmers's hardware has a programmable clock generator.
15. The self-testing procedure automatically executes at any time the programmer is powered on.

### 2.3.3 Software features

1. The ChipProgUSB software works under control of Windows XP, 7 (32- and 64-bit), 8.
2. Several methods of control are available: friendly and intuitive [Graphic User Interface](#) (GUI), [Command Line](#) control, Remote Control via the [Application Control Interface](#) (the DLL), [on-the-fly control](#) are

- included into the standard ChipProgUSB package.
3. Includes a set of basic commands: Blank Check, Erase, Read, Write, Verify, Lock, Set Configuration Bits, Data Memory Support, etc., executed by a single mouse click.
  4. Enables presetting a batch of the commands above executed one after one either by a manual start or by a mouse click or automatically upon the device insertion into the programming socket.
  5. Allows serialization of the programming devices with auto incrementing the device numbers and storing a serialization log (in the Auto Programming mode only).
  6. The program can calculate checksums of the selected data array and then write the checksum into a specified memory location of the target device (in the Auto Programming mode only). Several methods of the checksum calculation can be used.
  7. The program allows writing a unique signature into a specified memory location of the target device for the device identification (in the Auto Programming mode only).
  8. The project support speeds up and simplifies switching between different programming tasks.
  9. The software allows pre-programming a particular operation (or a chain of operations), which is supposed to be automatically triggered when the programmer hardware detects insertion of the target device into the programming socket.
  10. An unlimited number of memory buffers can be opened in the main ChipProgUSB window.
  11. The software supports a multiple programming mode for concurrent programming of the same type of target devices on the same type of programmers connected to one computer. A number of single device programmers connected to the programming cluster does not slow down the programming speed.
  12. The software includes a full-scale binary editor allowing manual modification of the data in buffers as well as such helpful functions as Search and Replace, Fill, Compare, Copy, Invert, Calculate Checksum, and OR, AND, XOR logical operations on the blocks of data.
  13. Loading and saving files in several standard and proprietary formats: Binary, Standard Extended Intel HEX, Motorola S-record, POF, JEDEC, PRG, Holtek OTP, ASCII HEC, ASCII OCTAL, Angstrom SAV. Special non-standard formats can be added upon request.
  14. The software is featured by a script language and a mechanism of handling the script scenarios for automation of the routine operations and chip replications.

## 2.4 ChipProg-40

The **ChipProg-40** universal programmer can be effectively used for both engineering and low-volume manufacturing. It supports in-socket and in-system programming of thousand of devices. The programmer hardware has some limitations for supporting certain devices. It does not support any PLDs. This is a difference between the cheaper **ChipProg-40** and the enhanced **ChipProg-48** model.



The programmer has a 40-pin DIP ZIF socket that enables inserting any wide or narrow DIP-packed devices with up to 40 leads without the necessity to use any additional adapters. Programming of other devices requires use of additional adapters available from Phyton and a few selected vendors. The programmer has three LEDs for displaying the programming status (“Good”, “Busy”, “Error”) and the “Start” button for fast launch of the pre-programmed command chains. The palm-size programmer has a wall-plugged power adapter that is not shown on the picture above.

**Standard package contents:**

- One programmer unit
- One power adapter 12V/1A+
- One USB link cable
- One CD with the ChipProgUSB software

Optionally the package may include one or more programming adapters (if ordered with the programmer) and a “QuickStart” printed manual. See also for more details:

[Major features](#)

[Hardware characteristics](#)

[Software features](#)

### 2.4.1 Major features

1. Equipped with a 40 pin ZIF socket that allows insertion of any DIP-packed devices with the package width from 300 to 600 mil (7.62 to 15.24 mm) and the number of leads up to 40 without additional adapters.
2. Links to a PC USB 2.0 compatible port, e.g. slower USB connection is also supported.
3. Provides fast programming; for example, completely writes a 64M bit NOR FLASH in less than 50 sec.
4. Can program target devices in the programmer ZIF socket as well as the devices installed in the

equipment (ISP mode).

5. An unlimited number of ChipProg-40 tools can be driven from multiple USB ports of one computer (or via a USB hub) to provide concurrent programming of multiple devices of the same type.
6. Has a button for fast manual launch of any single operation or a batch of operations.
7. Has three LEDs for displaying the programming status (“Good”, “Busy”, “Error”).

## 2.4.2 Hardware characteristics

1. The programmer has a 40-pin ZIF socket with a lever that enables the insertion and clamping of any DIP-packed devices with the package width from 300 to 600 mil (7.62 to 15.24 mm) and with the number of leads up to 40.
2. Adapters for programming devices in the SDIP, PLCC, SOIC, SOP, PSOP, TSOP, TSOPII, TSSOP, QFP, TQFP, VQFP, QFN, SON, BGA, CSP and other packages are available from Phyton and selected third parties.
3. The programmer is built on the base of a very fast and productive 32-bit embedded microcontroller and a FPGA. These resources allow adding new targets to the device list by a simple software update.
4. Most timing-critical parts of the programming algorithms are implemented in the FPGA devices.
5. Implementation in the FPGA devices logical drivers enables outputting logical signals of any level (low, high, Pullup, Pulldown and external clock generator) to any pin of the programming ZIF socket.
6. The programmers's hardware features 10-bit digital-to-analog converters for accurate settings of the analog signals.
7. The programmers's hardware enables accurate programming of the rising and falling edges of the generated analog signals.
8. The programmers's hardware automatically adjusts the generated analog signals in accordance to the target device programming specifications.
9. The generated analog signals for both the target supplying and programming can be outputted to any pins of the device being programmed.
10. The programmers's can connect any pin of the device being programmed to the “Ground” level.
11. The programmers's hardware checks if every pin of the target device is reliably fixed by a ZIF socket's contacts (“bad contact” checking).
12. The programmers's hardware protects itself and the target device against incorrect insertions and other issues that cause a sharp increase in the currents through the target device circuits. This “over current” protection is very fast and reliable.
13. The target device's pins are protected against the electrostatic discharge.
14. The programmers's hardware has a programmable clock generator.
15. The self-testing procedure automatically executes at any time the programmer is powered on.

## 2.4.3 Software features

1. The ChipProgUSB software works under control of Windows XP, 7 (32- and 64-bit), 8.
2. Several methods of control are available: friendly and intuitive [Graphic User Interface](#) (GUI), [Command Line](#) control, Remote Control via the [Application Control Interface](#) (the DLL), [on-the-fly control](#) are included into the standard ChipProgUSB package.
3. Includes a set of basic commands: Blank Check, Erase, Read, Write, Verify, Lock, Set Configuration Bits, Data Memory Support, etc., executed by a single mouse click.
4. Enables presetting a batch of the commands above executed one after one either by a manual start or by a mouse click or automatically upon the device insertion into the programming socket.
5. Allows serialization of the programming devices with auto incrementing the device numbers and storing a serialization log (in the Auto Programming mode only).
6. The program can calculate checksums of the selected data array and then write the checksum into a specified memory location of the target device (in the Auto Programming mode only). Several

methods of the checksum calculation can be used.

7. The program allows writing a unique signature into a specified memory location of the target device for the device identification (in the Auto Programming mode only).
8. The project support speeds up and simplifies switching between different programming tasks.
9. The software allows pre-programming a particular operation (or a chain of operations), which is supposed to be automatically triggered when the programmer hardware detects insertion of the target device into the programming socket.
10. An unlimited number of memory buffers can be opened in the main ChipProgUSB window.
11. The software supports a multiple programming mode for concurrent programming of the same type of target devices on the same type of programmers connected to one computer. A number of single device programmers connected to the programming cluster does not slow down the programming speed.
12. The software includes a full-scale binary editor allowing manual modification of the data in buffers as well as such helpful functions as Search and Replace, Fill, Compare, Copy, Invert, Calculate Checksum, and OR, AND, XOR logical operations on the blocks of data.
13. Loading and saving files in several standard and proprietary formats: Binary, Standard Extended Intel HEX, Motorola S-record, POF, JEDEC, PRG, Holtek OTP, ASCII HEC, ASCII OCTAL, Angstrom SAV. Special non-standard formats can be added upon request.
14. The software is featured by a script language and a mechanism of handling the script scenarios for automation of the routine operations and chip replications.

## 2.5 ChipProg-ISP

The **ChipProg-ISP** is an inexpensive universal device programmer for programming devices installed in the equipment. This type of programming is known as “in-system” or “in-circuit” programming. The **ChipProg-ISP** supports serial EPROM and EEPROM flash memory devices and embedded microcontrollers with the code and data memory programmable via different types of serial ports: UART, JTAG, SWD, SPI and other types, including proprietary interfaces.



The programmer has three LEDs for displaying the programming status (“Good”, “Busy”, “Error”) and the “Start” button for fast launch of the pre-programmed command chains. The tool shown on the picture is very small and requires no power adapter for the operations - it gets power from the USB computer port.



## Connecting ChipProg-ISP to the target

The programmer has a 14-pin output connector BH-14R. A variety of Phyton [adapting cables](#) allow connecting to the target. A simple pin-to-pin ribbon cable AS-ISP-CABLE is supplied with the programmer by default, and other cables (adapters) can be ordered on demand. The BH-14R connector output information signals for the chip programming and some service signals that enable using the programmer in the automated programming and testing equipment. See the BH-14R pinout:

ChipProg-ISP BH-14R connector	Logical signal
1	Target specific*
2	Target specific*
3	Target specific*
4	Target specific*
5	Target specific*
6	Target specific*
7	Target specific*
8	Target specific*
9	GND
10	Target specific*
11	/Start
12	/Error
13	/Good
14	/Busy

Signals on the pins #1 to #9 and on the pin #10 are used for transmitting and receiving information and synchro impulses to and from the target device. These signals are target specific and depend on the type of target device or a family in general (AVR, PIC, etc.) - see [here](#). They also are shown in the adapters wiring diagrams; see the file adapters.chm included in the ChipProgUSB set.

The pin #9 must be connected to the target's ground.

The signals on the output pins #12, #13 and #14 represent the programmer statuses - logical '0' means an active status, logical '1' - passive. E.g.:

/Error – the operation has failed;

/Good – the operation completed successfully;

/Busy – the programmer is in a process of executing some operation.

An active signal on the input pin #11 (log.'0') starts the preset operation, the device programming by default. Activation of this signal, e.g. a falling edge, is equivalent to pushing the "Start" button on the programmer. See the diagram below:

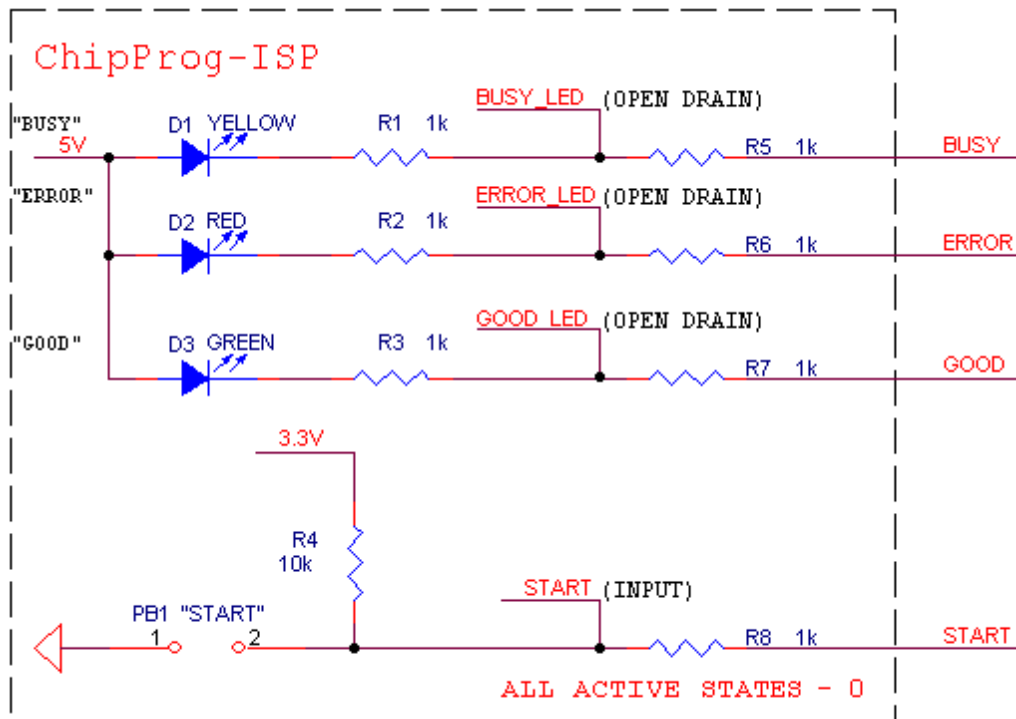

Read also [In-System Programming for different devices](#).

#### Standard package contents:

- One programmer unit
- One universal ribbon cable wired pin-to-pin
- One USB link cable
- One CD with the ChipProgUSB software

Optionally the package may include one or more programming cable-adapters (if ordered with the programmer) and a "QuickStart" printed manual. See also for more details:

#### [Major features](#)

#### [Hardware characteristics](#)

#### [Software features](#)

### 2.5.1 Major features

1. Has a 14 pin socket for connecting to the target equipment by means of several cable-adapters.
2. Protects itself and the target equipment against incorrect wiring.
3. Links to a PC USB 2.0 compatible port, e.g. slower USB connection is also supported.
4. An unlimited number of ChipProg-ISP tools can be driven from multiple USB ports of one computer (or via a USB hub) to provide concurrent programming of multiple devices of the same type.
5. Has a button for fast manual launch of any single operation or a batch of operations.
6. Has three LEDs for displaying the programming status ("Good", "Busy", "Error").

## 2.5.2 Hardware characteristics

1. Has a standard 14 pin connector.
2. By default is supplied with a flat ribbon cable with dual headers - 10- and 14 pins.
3. Optionally can be supplied with several cable adapters for programming specific device families.
4. The programmer is built on the base of a very fast and productive 32-bit embedded microcontroller and a FPGA device.
5. Most timing-critical parts of the programming algorithms are implemented in the FPGA devices.
6. Implementation in the FPGA devices logical drivers enable outputting logical signals of any level (low, high, Pullup, Pulldown and external clock generator) to any pin of the programming connector.
7. The programmers's hardware features 10-bit digital-to-analog converters for accurate settings of the analog signals.
8. The programmers's hardware enables accurate programming of the rising and falling edges of the generated analog signals.
9. The programmers's hardware automatically adjusts the generated analog signals.
10. The generated analog signals for both the target supplying and programming can be outputted to any pins of the device being programmed.
11. The programmers's hardware protects itself and the target device against incorrect connection.
12. The target device pins are protected against the electrostatic discharge.
13. Can be started from the external signal.
14. Three status signals "Good", "Busy", "Error" are outputted to the programmer connector for driving ATE equipment.
15. The self-testing procedure can be executed at any time by request.

## 2.5.3 Software features

1. The ChipProgUSB software works under control of Windows XP, 7 (32- and 64-bit), 8.
2. Several methods of control are available: friendly and intuitive [Graphic User Interface \(GUI\)](#), [Command Line](#) control, Remote Control via the [Application Control Interface](#) (the DLL), [on-the-fly control](#) are included into the standard ChipProgUSB package.
3. Includes a set of basic commands: Blank Check, Erase, Read, Write, Verify, Lock, Set Configuration Bits, Data Memory Support, etc., executed by a single mouse click.
4. Enables presetting a batch of the commands above executed one after one either by a manual start or by a mouse click or automatically upon the device insertion into the programming socket.
5. Allows serialization of the programming devices with auto incrementing the device numbers and storing a serialization log (in the Auto Programming mode only).
6. The program can calculate checksums of the selected data array and then write the checksum into a specified memory location of the target device (in the Auto Programming mode only). Several methods of the checksum calculation can be used.
7. The program allows writing a unique signature into a specified memory location of the target device for the device identification (in the Auto Programming mode only).
8. The project support speeds up and simplifies switching between different programming tasks.
9. The software allows pre-programming a particular operation (or a chain of operations), which is supposed to be automatically triggered when the programmer hardware detects insertion of the target device into the programming socket.
10. An unlimited number of memory buffers can be opened in the main ChipProgUSB window.
11. The software supports a multiple programming mode for concurrent programming of the same type of target devices on the same type of programmers connected to one computer. A number of single device programmers connected to the programming cluster does not slow down the programming speed.
12. The software includes a full-scale binary editor allowing manual modification of the data in buffers as well as such helpful functions as Search and Replace, Fill, Compare, Copy, Invert, Calculate

Checksum, and OR, AND, XOR logical operations on the blocks of data.

13. Loading and saving files in several standard and proprietary formats: Binary, Standard Extended Intel HEX, Motorola S-record, POF, JEDEC, PRG, Holtek OTP, ASCII HEC, ASCII OCTAL, Angstrom SAV. Special non-standard formats can be added upon request.
14. The software is featured by a script language and a mechanism of handling the script scenarios for automation of the routine operations and chip replications.

## 3 Quick Start

This chapter includes the topics that describe:

How to install the ChipProgUSB [software](#)

How to install the ChipProg [USB drivers](#)

How to install the ChipProg [hardware](#) and to start up the ChipProg programmers of different type.

It is **highly recommended** to read all the manual basic topics included in the chapters [Graphical User Interface](#) and [Operating with ChipProg programmers](#) before starting to use the tool.

It is assumed that you are an experienced user of MS Windows and basic Windows operations.

### 3.1 Installing the ChipProgUSB Software

Insert the distributive ChipProgUSB disc into a CD drive of your PC, click the **Install ChipProgUSB** button, accept the license agreement and then follow the series of prompts that will lead you through the installation process.

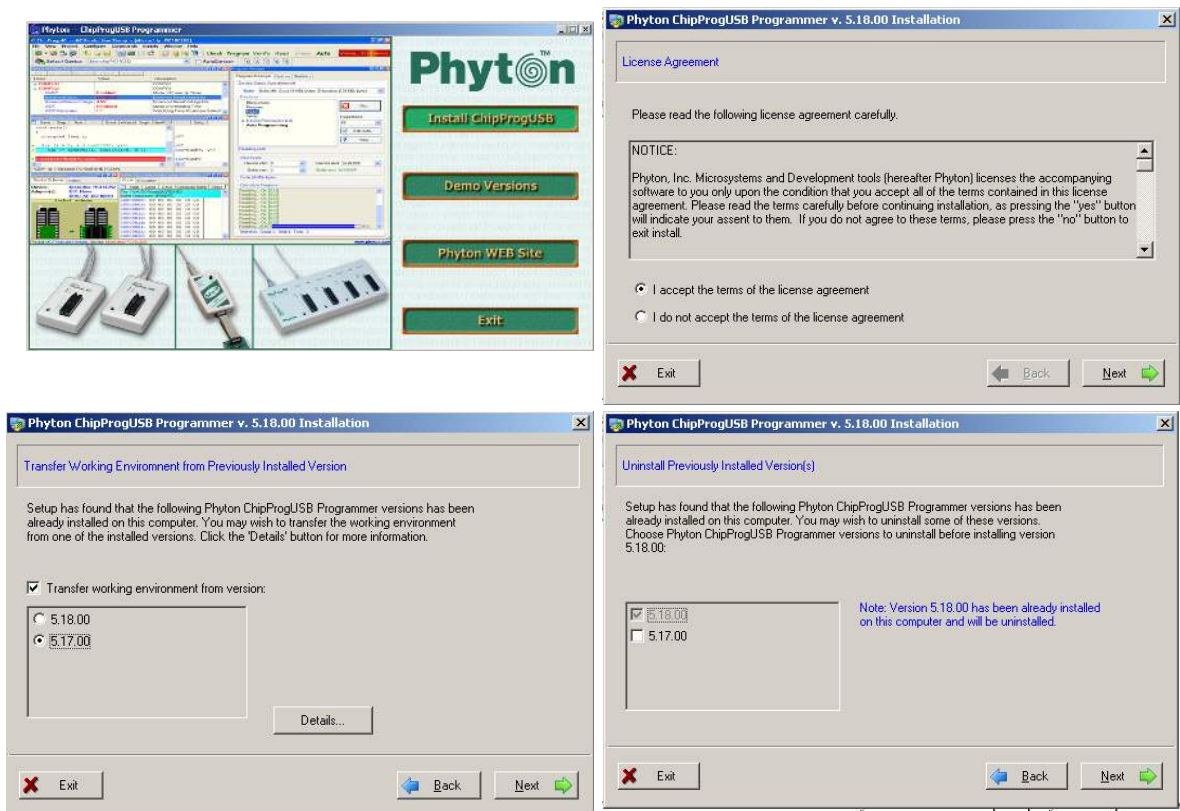

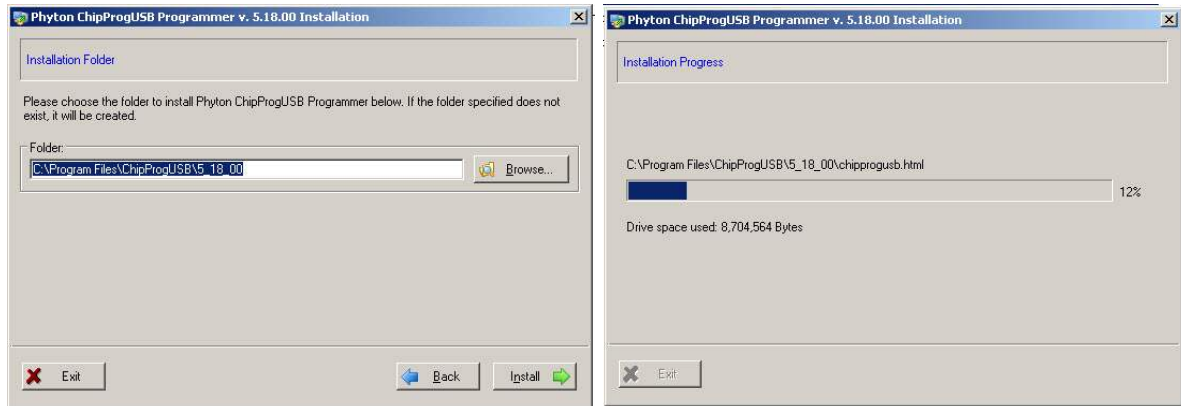

### Phyton ChipProgUSB folder

At the end the installer will create a folder with ChipProgUSB tools' and documents' shortcuts:

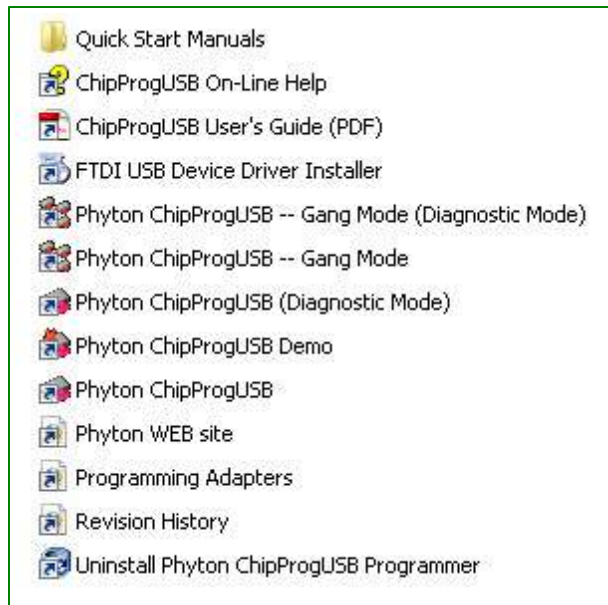

The folder **Quick Start Manuals** includes links to PDF manuals in the destination folder where the products has been installed.

The **ChipProgUSB On-Line Help** icon opens the programmer on-line Help document (.CHM).

The **ChipProgUSB User's Guide** icon opens a complete programmer user's guide in the PDF format.

The **FTDI USB Device Driver Installer** icon launches the utility allowing installing and uninstalling USB drivers.

The **Phyton ChipProgUSB -- Gang Mode (Diagnostic Mode)** icon invokes the ChipProgUSB executable file and starts operations on multiple ChipProg programmers connected to one computer in the diagnostic mode. In the diagnostic mode the programmer works considerably slower than it works in the working mode – do not use this mode unless Phyton required special diagnostic files for the troubleshooting.

The **Phyton ChipProgUSB – Gang Mode** icon invokes the ChipProgUSB executable file and starts operations for the ChipProg -G41 gang device programmer or the ChipProg-48, ChipProg-40 and ChipProg-ISP programmers working in a [multiprogramming mode](#).

The **Phyton ChipProgUSB (Diagnostic Mode)** icon invokes the ChipProgUSB executable file and starts operations for a single ChipProg-ISP programmer working in a single programming mode, e.g. when one programmer works on one target device. In the diagnostic mode the programmer works considerably slower – do not use this mode unless Phyton did not require special diagnostic files for the troubleshooting.

The **Phyton ChipProgUSB** icon invokes the ChipProgUSB executable file and starts operations for the ChipProg-48, ChipProg-40 and ChipProg-ISP programmers working in a [single programming mode](#).

The **Phyton ChipProgUSB Demo** icon invokes a demo version of the ChipProgUSB software that allows evaluating the product without having the programmer's hardware.

The **Phyton WEB site** icon opens the [www.phyton.com](http://www.phyton.com) website in your favorite Internet browser.

The **Programming Adapters** icon opens the adapters.chm file that list all the Phyton programming adapters with their short descriptions and wiring diagrams.

The **Revision History** icon opens the ChipProgUSB versions history file.

The **Uninstall Phyton ChipProgUSB Programmer** icon starts a process of removing the ChipProgUSB program from your computer.

## 3.2 Installing the USB Drivers

In a process of the ChipProgUSB software installation from a distributive disc the program installs the drivers for the USB devices used in all types of the ChipProg programmers working under control of the **Windows XP, Windows 7** (both 32- and 64-bit versions) and **Windows 8** Microsoft operating systems.

## 3.3 Hardware installation

It is a mandatory for you to use the original power adapter 12V/1A received with the ChipProg-40 or ChipProg -48 programmer and an original power cord for the ChipProg-G41 gang programmer. Any substitutions should be agreed to with [Phyton](#). It is also highly recommended to use the USB link cables received with the programmers.

The hardware installations for different programmer models vary. Select the topic to see:

- [The ChipProg-48 hardware installation](#)
- [The ChipProg-40 hardware installation](#)
- [The ChipProg-G41 hardware installation](#)
- [The ChipProg-ISP hardware installation](#)

### 3.3.1 ChipProg-481

#### For the programmer to be used in a single-programming mode:

<b>Powering the programmer</b>	Plug the <a href="#">power adapter</a> to the ~110/240V outlet. Connect a plug of the power adapters to the coaxial connector on the rear panel of the programmers and make sure that the "Good" green LEDs on each of them are on.
<b>Connecting to a PC</b>	Connect the USB port of your PC to the USB connector on the rear panel of the programmer by means of the <a href="#">USB cable</a> . It is recommended to connect the programmer to a USB slot on the computer main unit and do not connect it through a USB hub, especially through a passive hub.
<b>Starting up</b>	Start the <b>Phyton ChipProgUSB-01</b> program; if the programmer passes the startup test successfully the ChipProgUSB-01 main window will open and you will be able to work with the tool.

#### For the programmers to be used in a multi-programming mode, e.g. connected to one computer:

<b>Powering the programmers</b>	Plug the <a href="#">power adapters</a> of each programmer to be connected in one programming cluster to the 110/240V outlets. Connect plugs of the power adapters to the coaxial connectors on the rear panels of all the programmers and make sure that the "Good" green LEDs on each of them are on.
<b>Connecting the programmers to a cluster</b>	Connect the USB ports of your PCs to the USB connectors on the rear panels of the programmers by means of the <a href="#">USB cables</a> . It's recommended to connect the programmers to USB slots on the computer main unit and do not connect them through a USB hub, especially through a passive hub.
<b>Starting up</b>	Start the <b>Phyton ChipProgUSB-01 - Gang Mode</b> program; if all the programmers pass the startup test successfully the first dialog prompts you to assign the number from one to N to each programmer included in the cluster. To assign the number push a <b>Start</b> button on a top panel of each programmer one by one. Then the ChipProgUSB-01 main window will open and you will be able to work with the tool.

Read about the [Multi-Programming mode](#).



### 3.3.2 ChipProg-G41

<b>Powering the programmer</b>	Plug the power cord to a power connector on the rear panel of the programmer, then plug an opposite site to the ~110/240V outlet. Make sure that all four "Good" green LEDs on the programmer are on.
<b>Connecting to a PC</b>	Connect a USB port of your PC to a USB connector on the rear panel of the programmer by means of the <a href="#">USB cable</a> . It's highly recommended to connect the programmer to a USB slot on the computer main unit and not connect it through a USB hub, especially through a passive hub. Use of the passive USB hubs for connecting the ChipProg-G41 programmer is not allowed.
<b>Starting up</b>	<p><b>Important! When you start the programmer first time wait for about 20 seconds to allow the USB driver to be setup. Then, every time when you start the programmer, wait for 5...10 sec before launching the ChipProgUSB-01 software.</b></p> <p>Start the <b>Phyton ChipProgUSB-01 - Gang Mode</b> program; if all the programmers pass the startup test successfully the first dialog prompts you to assign the number from one to N to each programming site. To assign the number push an appropriate <b>Start</b> button on a top panel of the programmer one by one. Then the ChipProgUSB-01 main window will open and you will be able to work with the tool.</p>

### 3.3.3 ChipProg-48

#### For the programmer to be used in a single-programming mode:

<b>Powering the programmer</b>	Plug the <a href="#">power adapter</a> to the ~110/240V outlet. Connect a plug of the power adapters to the coaxial connector on the rear panel of the programmers and make sure that the "Good" green LEDs on each of them are on.
<b>Connecting to a PC</b>	Connect the USB port of your PC to the USB connector on the rear panel of the programmer by means of the <a href="#">USB cable</a> . It is highly recommended to connect the programmer to a USB slot on the computer main unit and do not connect it through a USB hub, especially through a passive hub.
<b>Starting up</b>	Start the <b>Phyton ChipProgUSB</b> program; if the programmer passes the startup test successfully the first dialog prompts you to choose one of the programmers to work with: ChipProg-48, ChipProg-40 or ChipProg-ISP. Select the ChipProg-48 and continue. The ChipProgUSB main window will open and you will be able to work with the tool.

#### For the programmers to be used in a multi-programming mode, e.g. connected to one computer:

<b>Powering the programmers</b>	Plug the <a href="#">power adapters</a> of each programmer to be connected in one programming cluster to the 110/240V outlets. Connect plugs of the power adapters to the coaxial connectors on the rear panels of all the programmers and make sure that the "Good" green LEDs on each of them are on.
<b>Connecting the programmers to a cluster</b>	Connect the USB ports of your PCs to the USB connectors on the rear panels of the programmers by means of the <a href="#">USB cables</a> . It's highly recommended to connect the programmers to USB slots on the computer main unit and do not connect them through a USB hub, especially through a passive hub.
<b>Starting up</b>	Start the <b>Phyton ChipProgUSB - Gang Mode</b> program; if all the programmers pass the startup test successfully the first dialog prompts you to assign the number from one to N to each programmer included in the cluster. To assign the number push a <b>Start</b> button on a top panel of each programmer one by one. Then the ChipProgUSB main window will open and you will be able to work with the tool.

Read about the [Multi-Programming mode](#).

### 3.3.4 ChipProg-40

**For the programmer to be used in a single programming mode, e.g. alone:**

<b>Powering the programmer</b>	Plug the <a href="#">power adapter</a> to the ~110/240V outlet. Connect a plug of the power adapter to the coaxial connector on the rear panel of the programmer and make sure that the "Good" green LED on the programmer is on.
<b>Connecting to a PC</b>	Connect a USB port of your PC to a USB connector on the rear panel of the programmer by means of the <a href="#">USB cable</a> . It's highly recommended to connect the programmer to a USB slot on the computer main unit and not connect it through a USB hub, especially through a passive hub.
<b>Starting up</b>	Start the <b>Phyton ChipProgUSB</b> program; if the programmer passes the startup test successfully the first dialog prompts you to choose one of the programmers to work with: ChipProg-48, ChipProg-40 or ChipProg-ISP. Select the ChipProg-40 and continue. The ChipProgUSB main window will open and you will be able to work with the tool.

**For the programmers to be used in a multi-programming mode, e.g. connected to one computer:**

<b>Powering the programmers</b>	Plug the <a href="#">power adapters</a> of each programmer to be connected in one programming cluster to the 110/240V outlets. Connect plugs of the power adapter to the coaxial connectors on the rear panels of all the programmers and make sure that the "Good" green LEDs on each of them are on.
<b>Connecting the programmers to a cluster</b>	Connect USB ports of your PCs to USB connectors on the rear panels of the programmers by means of the <a href="#">USB cables</a> . It's highly recommended to connect the programmers to USB slots on the computer main unit and not connect them through a USB hub, especially through a passive hub.
<b>Starting up</b>	Start the <b>Phyton ChipProgUSB - Gang Mode</b> program; if all the programmers pass the startup test successfully the first dialog prompts you to assign the number from one to N to each programmer included in the cluster. To assign the number push a <b>Start</b> button on a top panel of each programmer one by one. Then the ChipProgUSB main window will open and you will be able to work with the tool.

Read about the [Multi-Programming mode](#).

### 3.3.5 ChipProg-ISP

**For the programmer to be used in a single programming mode, e.g. alone:**

<b>Connecting to a PC</b>	Connect a USB port of your PC to a USB connector on the rear panel of the programmer by means of the <a href="#">USB cable</a> . Make sure that the "Good" green LED on the programmer is on. It's highly recommended to connect the programmer to a USB slot on the computer main unit and not connect it through a USB hub. Use of the passive USB hubs for connecting the ISP programmers is not allowed.
<b>Starting up</b>	Start the <b>Phyton ChipProgUSB</b> program; if the programmer passes the startup test successfully the first dialog prompts you to choose one of the programmers to work with: ChipProg-48, ChipProg-40 or ChipProg-ISP. Select the ChipProg-ISP and continue. The ChipProgUSB main window will open and you will be able to work with the tool.

**For the programmers to be used in a multi-programming mode, e.g. connected to one computer:**

**Connecting the programmers to a cluster**

Connect USB ports of your PCs to USB connectors on the rear panels of the programmers by means of the [USB cables](#). Make sure that the "Good" green LEDs on all the programmers are on. It's highly recommended to connect the programmers to USB slots on the computer main unit and not connect them through a USB hub. The ChipProg programmers get power from the computer's USB port; that is why it's important not to overload the ports. Use of the passive USB hubs for clustering the ISP programmers is not allowed.

**Starting up**

Start the **Phyton ChipProgUSB - Gang Mode** program; if all the programmers pass the startup test successfully the first dialog prompts you to assign the number from one to N to each programmer included in the cluster. To assign the number push a **Start** button on a top panel of each programmer one by one. Then the ChipProgUSB main window will open and you will be able to work with the tool.

Read about the [Multi-Programming mode](#).

## 3.4 Getting Assistance

### 3.4.1 On-line Help

The ChipProgUSB software has a pretty comprehensive context-sensitive on-line **Help**. To access it press the **F1** key or use the [Help menu](#). Almost every ChipProgUSB dialog, message box and menu has its own context-sensitive help, which can be invoked for the active dialog or menu by pressing **F1**.

In most cases you can find the necessary topic by searching for a keyword. For example, if you type "Verify" in the first box of the **Find** tab, the third box will list the topics related to the programming verification. Choose an appropriate topic from this list and press **Display**.

### 3.4.2 Technical Support

During a product's warranty period Phyton provides technical support free of charge. Though we have been selling the ChipProg programmers for many years the product software may contain minor bugs and some programming algorithms may not be stable on some of the supported devices. We kindly ask you to report bugs when you get an error message or have a problem with programming a particular device or devices. We commit to prompt checking of your information and fixing the detected bugs.

To minimize difficulties operating with ChipProgUSB it is highly recommended to get familiar with the manual before using the programmer. The ChipProgUSB - [user interface](#) is quite standard and intuitive, however it includes some specific functions and controls that the user should learn about.

#### **Before contacting Phyton**

- Make sure that you use the latest ChipProgUSB version that is always available for free download from the <http://www.phyton.com>.
- Make sure the detected error can be reproduced in the same working environment and is not a casual glitch.

#### **When contacting us**

Please, provide our technical support specialists with the following information:

- Your name, the name of your company, your contact telephone number and your e-mail address.
- Name of the ChipProg model and its serial number, if one exists.
- Date of purchase, the Phyton invoice number, if available.

- Software version number taken from the [About](#) information box.
- Basic parameters of your computer and operating system.
- The device type, mechanical package and the type of the adapter if one is used.
- Descriptions of detected errors, relevant bug reports and error screen shots.

Please send your requests or questions to [support@phyton.com](mailto:support@phyton.com). This is the easiest way to get professional and prompt help. Also, see [Contact Information](#).

### 3.4.3 Contact Information

#### **Phyton Inc., Microsystems and Development Tools**

7206 Bay Parkway, 2nd floor  
Brooklyn, New York 11204  
USA

**Web address:** [www.phyton.com](http://www.phyton.com)

**E-mail contacts:**

**General inquiry:** [info@phyton.com](mailto:info@phyton.com)

**Sales:** [sales@phyton.com](mailto:sales@phyton.com)

**Technical Support:** [support@phyton.com](mailto:support@phyton.com)

**Tel:** 1-718-259-3191

**Fax:** 1-718-259-1539

## 4 ChipProg Control Options

ChipProg device programmers can be controlled either from a personal computer or remotely from Automatic Test Equipment (ATE) or any proprietary computerized environment connected to a PC directly driving a single ChipProg device programmer a gang programmer or a programming cluster comprised on multiple ChipProg units. Driving a ChipProg programmer (or multiple programmers) from a PC can be provided via a friendly and intuitive [Graphic User Interface](#), [Command Line](#) or by launching [Script Files](#). Driving a ChipProg programmer (or multiple programmers) remotely can be done via the DLL supplied with the ChipProgUSB software.

## 4.1 Graphical User Interface

The ChipProgUSB and ChipProgUSB-01 graphical user interface (GUI) elements include:

- [Menus](#) - global and local
- [Windows](#)
- [Toolbars](#) - global and local
- Setting Dialogs
- [Hot Keys](#)
- Context-sensitive [help prompts](#)

The GUI is featured with [several useful additions](#) specifically created for the ChipProg operations.

**To make your operations with the ChipProgUSB and ChipProgUSB-01 programs easier we highly recommend to learn the chapters [Menus](#) and [Windows](#) in full. You will be able to use the ChipProg device programmers much more effectively.**

### 4.1.1 User Interface Overview

ChipProgUSB features the standard Windows interface with several useful additions:

1. Each window has its own local menu (the shortcut menu). To open this menu, click the right mouse button within the window area or press **Ctrl+Enter** or **Ctrl+F10**. Each command in the menu has a hot key shortcut assigned to the **Ctrl+<letter>** keys. Pressing the hot key combination in the active window executes the corresponding command.
2. Each window has its own local toolbar. The window's toolbar buttons give access to most of the window's local menu commands. The specialized window toolbar buttons operate only within the specialized window. The main ChipProgUSB window has several toolbars that can be turned on or off (in the **Environment** dialog, the [Toolbar tab](#)).
3. Each toolbar button has a short prompt: when you place the cursor over a toolbar button for two seconds, a small yellow box appears nearby with a short description of the button's function.
4. To save screen space, you can hide any window's title bar. To do this, use the **Properties** command of the local menu. You can identify the ChipProgUSB windows by their contents and position on the screen (and, if you wish, by color and font). When the title bar is hidden, you can move the window as if the toolbar were the title bar: place the cursor on the free space of the toolbar, press the left mouse button and drag the window to a new position.
5. You can open any number of windows of the same type. For example, you can open several **Buffer** windows.
6. Every input text field of any dialog box has a history list. ChipProgUSB saves them when you close a development session. Then a previously entered string can be picked from the history list.
7. All input text boxes in the dialogs feature automatic name completion.
8. All check boxes and radio buttons in the dialogs work in the following way: a double-click on the check box or radio button is equivalent to a single click on the box or button, followed by a click on the **OK** button. This is convenient when you need to change only one option in the dialog and then close it.

## 4.1.2 Toolbars

The ChipProgUSB program opens a few toolbars on top of the main window (see below).

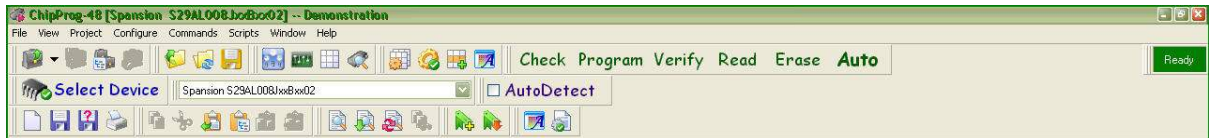

The top line, shown right under the ChipProg main window title, includes the [Main menu](#) submenus. A second line under the Main menu line displays icons and buttons of most frequently used commands on files and target devices (Open project, Load file, Save file... Check, Program, Verify, etc.). There is an indicator of the ChipProgUSB status (Ready, Wait, etc.). The third line displays a target device selector. The fourth line, which is not displayed by default, includes an embedded editor options and commands for scripts. The default toolbars can be customized. Read also the topics: [The Configure Menu](#), [The Environment dialog](#), [Toolbar](#).

Besides the toolbars positioned on a top of the main window, each particular window has its own local toolbar with the buttons presenting the most popular commands associated with the window. See for example the [Buffer window's](#) toolbar below.

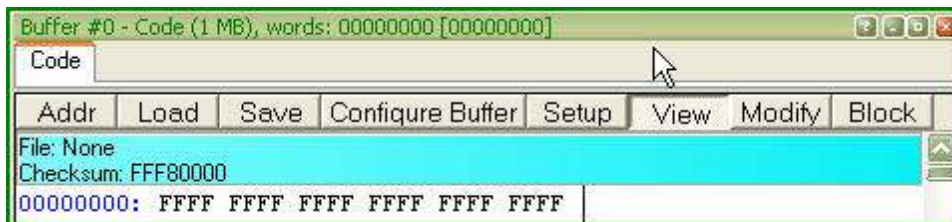

## 4.1.3 Menus





The ChipProgUSB Main menu bar includes the following pull-down sub-menus:

- [File menu](#)
- [View menu](#)
- [Project menu](#)
- [Configure menu](#)
- [Commands menu](#)
- [Scripts menu](#)
- [Window menu](#)
- [Help menu](#)

To access these menus, use the mouse or press **Alt+letter**, where "letter" is the underlined character in the name of the menu item.

#### 4.1.3.1 The File Menu

The **File** menu's commands control the file operations. For those commands that have a toolbar button, the button is shown in the first column of the table below. If there is a shortcut key for a command, the shortcut key is shown at the right of the command in the menu.

<u>Button</u>	<u>Command</u>	<u>Description</u>
	<b>Load ...</b>	Opens the <a href="#">Load file</a> dialog that specifies all the parameters of the file to be loaded and the file destination.
	<b>Reload</b>	Reloads the most recently loaded file.
	<b>Save...</b>	Saves the file from the currently active window to a disk. Opens the <a href="#">Save file from buffer</a> dialog.
	<b>Configuration Files</b>	Gives access to operations with <a href="#">configuration files</a> .
	<b>Exit</b>	Closes ChipProgUSB. Alternatively, use the standard ways to close a Windows application (the <b>Alt+F4</b> or <b>Alt+X</b> keys combination).







#### 4.1.3.1.1 Configuration Files

On exit ChipProgUSB automatically saves its configuration data in several configuration files with the name **UPROG**. On start, it restores its configuration from the last saved configuration files. In addition, you can save and load any of these files at any time using the **Configuration Files** command of the [File menu](#). You can have several sets of configuration files for different purposes.

- The **Desktop** file contains data about the display options and the screen configuration, and the positions, dimensions, colors and fonts of all the opened windows. The extension of this file is **.dsk**. The default file name is **UPROG.dsk**.
- The **Options** file stores the target device type, file options, etc. The extension of this file is **.opt**. The default file name is **UPROG.opt**.
- The **Session** file, which stores session data and specifies the desktop and options; it can also be saved and loaded by means of the **Save session** or **Load session** sub command of the **Configuration Files** command. The extension of this file is **.ses**. The default file name is **UPROG.ses**.
- The **History** file, which contains all the settings entered in the text boxes of all the ChipProgUSB dialogs. This file is hidden from users, but the settings stored earlier are available for prompt pick up from the History lists. The extension of this file is **.hst**. The default file name is **UPROG.hst**.

#### 4.1.3.2 The View Menu

This menu controls access to the ChipProgUSB windows:

<u>Button</u>	<u>Command</u>	<u>Description</u>
	<b>Program Manager</b>	Opens the <a href="#">Program Manager</a> dialog.
	<b>Device and Algorithm Parameters</b>	Opens the <a href="#">Device and Algorithm Parameters</a> dialog.
	<b>Buffer Dump</b>	Opens the <a href="#">Buffer</a> dialog.
	<b>Device Information</b>	Opens the <a href="#">Device Information</a> dialog.
	<b>Console</b>	Opens the <a href="#">Console</a> dialog.







#### [Local window menus](#)

Each window has its own local (shortcut) menu. To open a local window menu, either click the right mouse button within the window or press **Ctrl+Enter** or **Ctrl+F10**.

Most, but not all, of the local menu commands are duplicated by local toolbar buttons that are usually displayed at the top of every window.

### 4.1.3.3 The Project Menu

This menu contains commands for working with [projects](#).

<u>Button</u>	<u>Command</u>	<u>Description</u>
	<b>New</b>	Opens the <a href="#">Project Options</a> dialog.
	<b>Open</b>	Opens the <a href="#">Open Project</a> dialog for loading an existing project file.
	<b>Close</b>	Saves and closes a currently opened project.
	<b>Save</b>	Saves a currently opened project with all its settings.
	<b>Save As</b>	Opens the <b>Save project</b> dialog. Duplicating projects under different names and/or in different folders is helpful for cloning similar projects.
	<b>Repository</b>	Opens the <a href="#">Project Repository</a> dialog for storing a current project in a special data base for convenient handling.
	<b>Options</b>	Opens the <a href="#">Project Options</a> dialog for the project options editing.

**Note!** The ChipProgUSB software does not automatically save changes of the project options upon quitting the program. You must execute the **Save** or **Save as** command from the [Project](#) menu to preserve project changed made in all user interface setting dialogs since opening this project.

#### 4.1.3.3.1 The Project Options Dialog

This dialog is used for initial setting and editing the project options.

Element of dialog	Description
<b>Project File Name</b>	Specifies the project file name and path. The extension may be omitted. when you close the dialog by clicking the OK button the program save the project file with the extension <b>.upp</b> .
<b>Permissions...</b>	Opens the <b>Editing Permission Settings</b> dialog. Here you can protect the project file against unauthorized editing. By checking appropriate boxes in this dialog you can lock major groups of project options.

<b>Project Description (optional)</b>	Here you can enter your custom comments for the project.
<b>Desktop</b>	Two radio buttons which allow you to choose if a current project has its own desktop or if all ChipProgUSB projects will use the same desktop settings.
<b>Files to Load to Buffers</b>	File or list of files to be loaded into the buffers upon opening the project.
<b>Add file</b>	Opens the <a href="#">Load File</a> dialog for adding this file to the <b>Files to Load to Buffers</b> .
<b>Remove file</b>	Remove the selected file from field <b>Files to Load to Buffers</b> .
<b>Edit file options</b>	Opens the <a href="#">Load File</a> dialog for editing a file highlighted in the <b>Files to Load to Buffers</b> list .
<b>Script to execute before loading files:</b>	Here you can enter the script name to be executed before loading the files to the project.
<b>Script to execute after loading files:</b>	Here you can enter the script name to be executed after loading the files to the project.

The dialog should be completed by clicking the **OK** button. Then a specified project file with the extension **.upp** will appear in a specified folder.

#### 4.1.3.3.2 The Open Project Dialog

This dialog is used to open a previously created project.

Element of dialog	Description
<b>Project File Name</b>	Here you can type in a full path to the project file name or to browse for the project file to be open. The ChipProgUSB project files have extensions <b>.upp</b> .
<b>Project Open History</b>	Lists previously opened projects. Double-clicking a line in the list opens a corresponding project.
<b>Remove from list</b>	Deletes a selected project from the <b>Project Open History</b> list.

#### 4.1.3.3.3 Project Repository

The **Project Repository** is a small database that stores records with links to the project files. Here you can see the ChipProg projects in a tree form similar to the Windows File Explorer, to sort and group the projects as needed for better presentation and convenient access. Operations with the repository do not change the project files themselves - the repository works only with records about the projects (links to the project files). A tree branch may show projects and other branches. Any branch may contain different projects with the same names. Different branches may contain links to the same project.

To open the **Project Repository** tree with associated commands call the **Repository** command of the [Project menu](#). Each tree branch displays the name of a particular project file (without a path) and the project description shown in square brackets. The ChipProgUSB remembers the state of the tree

branches (expanded / collapsed) and restores it next time you open the dialog.



When you install a new version of the ChipProgUSB software and copy the working environment from the previously installed version, the new version will inherit the existing project repository (the **repos.ini** file).

Element of dialog	Description
<b>Add New Branch</b>	Opens the <b>Add New Branch</b> dialog in which you can specify the name of a new branch.
<b>Add a Project to Branch</b>	Opens the <a href="#">Open Project</a> dialog to select a project to be added. Clicking the <b>Open</b> button adds the selected project to the selected branch.
<b>Add Current Project to Branch</b>	Adds the currently opened project to the selected branch.
<b>Remove Project/Branch</b>	Deletes the selected project or branch from the repository. All the child branches will be also deleted.  When deleting a project from the repository, the ChipProgUSB deletes only the repository record about the project, and <b>does not delete the project from the disc.</b>
<b>Edit Branch Name</b>	Opens the <b>Edit Branch Name</b> dialog for the selected branch.
<b>Move Up</b>	Moves a selected project or branch up within the same level of hierarchy. The branch moves together with all its child branches .
<b>Move Down</b>	Moves the selected project or branch down within the same level of hierarchy. The branch moves together with all its child branches .
<b>Save Repository</b>	Writes or updates the repository to the disc file <b>repos.ini</b> in the ChipProg working folder.
<b>Browse Project Folder</b>	Opens MS Windows Explorer with the opened folder of the selected project.
<b>Open Project</b>	Writes the repository to the disk file and opens a selected project.
<b>Close</b>	Closes the dialog. If the repository is changed, ChipProgUSB will prompt to save it.

#### 4.1.3.4 The Configure Menu

This menu gives access to all the ChipProgUSB configuration dialogs.

<u>Button</u>	<u>Command</u>	<u>Description</u>
	<b>Select device ...</b>	Opens the <a href="#">Select Device</a> dialog.
	<b>Device selection history</b>	Lists the previously selected devices.

	<b>Buffers</b>	Opens the <a href="#">Buffers</a> dialog.
	<b>Serialization, Checksum, Log file</b>	Opens the <a href="#">Serialization, Checksum, Log File</a>
	<b>Preferences</b>	Opens the <a href="#">Preferences</a> dialog.
	<b>Environment</b>	Opens the <b>Environment</b> dialog with tabs: the <a href="#">Fonts tab</a> , the <a href="#">Colors tab</a> , the <a href="#">Key Mappings tab</a> , the <a href="#">Toolbar tab</a> and the <a href="#">Misc tab</a> .

#### 4.1.3.4.1 The Select Device dialog

The dialog allows specification of the device to work with; it has a few groups of settings.

Element of dialog	Description
<b>Devices to list:</b>	<p>In this field you can check the box or boxes to specify the target device type. All the devices are divided in three functional groups: a) EPROM, EEPROM, FLASH; b) PLD, PAL, EPLD; c) Microcontrollers - check one, two or all three boxes. Two check boxes below specify a method of programming - in the programmer socket or in the target system - some devices can be programmed in either way, some only in one certain way.</p> <p>It is recommended to narrow down the searchable database and speed up the search by specifying the device properties if possible.</p>
<b>Manufacturer</b>	The box lists the device manufacturers in alphabetic order.
<b>Search mask:</b>	Here you can enter a mask to speed up the device search. The character '*' masks any number of any characters in the device part number. For example, the mask 'PIC18*64' will bring up all the PIC18 devices ending with the '64'.
<b>Devices</b>	The file displays all the devices for a chosen manufacturer that match to the search criteria specified in the <b>Devices to list</b> , <b>Search mask</b> and <b>Packages/Adapters</b> fields.
<b>Packages/Adapters</b>	This field lists all types of the chosen device's mechanical packages that can are supported by the the ChipProg and appropriate adapters.

#### 4.1.3.4.2 The Buffers dialog

Element of dialog	Description
<b>Buffer list:</b>	Displays names, sizes and sub-layers of all currently open <a href="#">buffers</a>

<b>Add...</b>	Opens the <a href="#">Buffer Configuration</a> dialog to create a new buffer
<b>Delete</b>	Deletes the buffer highlighted in the 'Buffer list' box.
<b>Edit...</b>	Opens the <a href="#">Buffer Configuration</a> dialog for editing.
<b>View</b>	Switches control to window displaying the buffer highlighted in the 'Buffer list' box. If this window is hidden under others it will be brought to the foreground.
<b>Memory Allocation</b>	This drop down menu allows limiting the memory size allocated from the computer RAM to each buffer. The free memory currently available for the allocation is shown here in this screen area.
<b>Swap Files</b>	If the RAM space is limited the ChipProgUSB can use some space on the PC drives by temporary writing the buffer image to the drive. You can select the drive or allow the program to swap the files automatically.
<b>Use network drives</b>	Checking this box enables you to swap files on the network drives connected to your computer.
<b>Amount of space to leave free on each drive (GB):</b>	Here you can limit the space on the drive which will be never affected by the file swapping.

#### 4.1.3.4.2.1 The Buffer Configuration dialog

The **Buffer Configuration** dialog allows the setup of sub-layers in the buffers and to make their presentation easier to work with.

The dialog includes as many tabs as number of sub-layers exist for a particular device. Every buffer has at least one [main layer](#), so the tab 'Code' is always displayed on the dialog foreground. If a chosen device has other address spaces ('Data', 'User', etc.) the buffer has additional [sub-layers](#) available for setting up by clicking the appropriate tabs.

The tab opens the dialog for configuring the main buffer layer - the 'Code' layer.

Element of dialog	Description
<b>Buffer Name</b>	Here you can type in a name for the buffer or pick it from the history list. By default the first opened buffer gets the name "Buffer #0". Then you can open the "Buffer #1", etc. or give the buffer any name you wish.
<b>Size of sub-layer 'Code'</b>	Here you can assign a size of the 'Code' layer from the drop-down menu - from 128KB to 32MB.
<b>Fill sub-layer 'Code' with data:</b>	The program fills the buffer sub-layers with some default information, usually by the 'FF's or zeros. By checking these boxes you specify when the layer 'Code' should be filled with the default information - before loading the file or right after the device type has been chosen.

<b>Data to fill sub-layer with:</b>	These two toggled radio buttons define if the sub-layer 'Code' will be filled with some default information, specific for the selected device, or by the custom bit pattern.
<b>Shrink buffer size when device is selected</b>	The buffer size usually exceeds the target device 'Code' size. By checking this box you downsize the buffer to match the target device and to free some computer memory.

The tab opens the dialog for presetting the buffer sub-layers.

Element of dialog	Description
<b>Fill sub-level 'ID location' with data:</b>	By checking these boxes you specify when the chosen sub-layer should be filled with the default information - before loading the file or right after the device type has been chosen..
<b>Data to fill sub-level with:</b>	These two toggled radio buttons define if the chosen sub-layer will be filled with some default information, specific for the selected device, or by the custom bit pattern..

#### 4.1.3.4.3 The Serialization, Checksum and Log dialog

The dialog allows writing serial numbers, unique signatures, checksums and user-specified information into the target device memory and logging a process of the mass production device programming.

### Important Notice!

**All the functions available with these dialogs: Serialization, writing in Checksums, Signatures, etc.  
work ONLY when you use the Auto Programming mode for mass production.**

#### Concept of shadow areas

Shadow areas are special memory locations that **do not** belong to the [buffer](#); they locate in a separate part of the computer's RAM. The content of the shadow areas that may include: individual chip serial numbers, the buffer checksums, special signatures, constancies, etc., is not specified in the source file loaded to the buffer. It can be set either manually in the ChipProg user interface or remotely via the Application Control Interface. There are several shadow areas for each [buffer layer](#) - three for dedicated parameters: [Serial Number](#), [Checksum](#), and [Signature String](#) plus multiple [Custom Shadow Areas](#) can be specified in this dialog. Tabs of the dialog below enable manually setting the parameters and methods of their calculation:

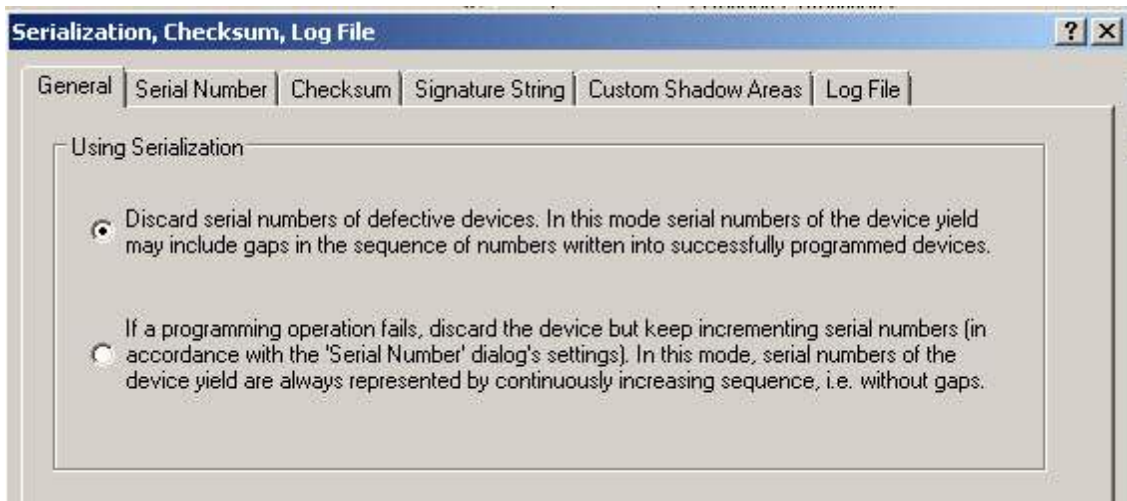

### [General](#)

### [Serial Number](#)

### [Checksum](#)

### [Signature String](#)

### [Custom Shadow Areas](#)

### [Log File](#)

When one launches the [Program](#) a command the ChipProgUSB merges: a) the data loaded to buffers and b) special data set in the shadows areas and then writes the merged data array into the target memory device. If some addresses of the merged data overlap each other then the data taken from the shadow areas overwrite ones taken from the memory buffer and the merged data physically [move](#) to the target device memory.

#### 4.1.3.4.3.1 General settings

The tab opens the dialog allowing to handle serialization of the devices failed in a process of the device programming. There are two options (see below in the picture below):



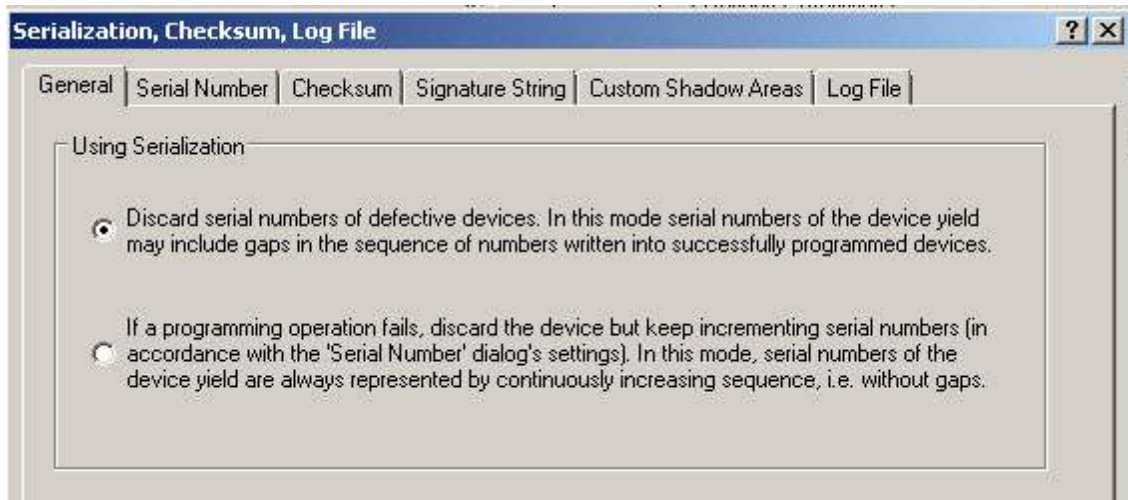

#### 4.1.3.4.3.2 Device Serialization

The **Serial Number** dialog tab specifies a procedure of assigning a unique number to each single device belonging to a series of devices being programmed. By default serial numbers starts from 0, increments by 1 and are displayed as a byte.

Element of dialog	Description
<b>Write S/N to address:</b>	If this box is checked the programmer will write a serial number into a specified address of a specified memory layer of a target device in accordance to the parameters below.
<b>Current serial number:</b>	Specify the current (start) serial number in this box. By default it is 0.
<b>S/N size, in byte:</b>	Specify a size of the serial number in bytes; for example: 1, 2, 4, etc. By default one byte is set here.
<b>Byte Order</b>	These two toggled radio buttons define an order of bytes that represent the serial number (if it occupies more than one byte) - either the least significant byte (LSB) follows the most significant byte (MSB) or vice versa.
<b>Display S/N as:</b>	These radio buttons set the serial number display format - decimal or hexadecimal.
<b>Increment serial number by:</b>	By checking this radio button you set incrementing the serial number by the fixed value specified here; for example: 1, 2, 10, etc.
<b>Use script to increment serial number:</b>	By checking this radio button you specify the increment value as a result of executing a chosen script file.

## 4.1.3.4.3.3 Checksum

The **Checksum** dialog allows auto calculating checksums of the data in buffers and writing this checksum into the target device's memory. The dialog enables you to specify either a "standard", widely used algorithm or a custom, complex algorithms by using a [script](#).

Element of dialog	Description
<b>Write checksum to address:</b>	If this box is checked the programmer will write a checksum into a specified address of a specified memory layer of a target device in accordance to the parameters below.
<b>Address range for checksum calculation:</b>	There are two options for setting the address range: <b>Auto</b> and <b>User-defined</b> .
<b>Auto:</b>	The address is defined as a full range of the selected device's memory layer. It is set by default.
<b>User-defined:</b>	Here you can specify the start and end addresses of the selected device memory layer, for which the program calculates the checksum.
<b>Use algorithm to calculate checksum:</b>	Here you can pick one from the drop down menu of several algorithms. By default it sets the "Summation, discard overflow".
<b>Use script to calculate checksum:</b>	By checking this radio button you specify a method of the checksum calculation as a result of executing a chosen script file.
<b>Size of calculation result:</b>	These radio buttons allow to choose a size of the checksum calculation: one, two or four bytes.
<b>Size of data being summed:</b>	These radio buttons allow to choose a size of the data being summed: one, two or four bytes.
<b>Operation on summation result:</b>	These radio buttons allow either to apply no operation on the calculated checksum or to negate or to complement the result.
<b>Byte Order:</b>	These two toggled radio buttons define an order of bytes that represent the checksum - either the least significant byte (LSB) follows the most significant byte (MSB) or vice versa.
<b>Exclude the following areas from checksum calculation:</b>	If the box is checked you can specify several memory ranges that will be skipped by any algorithm that calculate the checksum. To specify these ranges specify the start and end addresses and click the 'Add' button.

## 4.1.3.4.3.4 Signature string

The dialog specifies a procedure of writing a user-defined signature string into the target device. The signature may include some generic data like the date when the device has been programmed and some unique data like the project name, the operator name, etc..

Element of dialog	Description
<b>Write Signature String to address:</b> <b>in sub-layer:</b> <b>Max. size signature string:</b>	If this box is checked the programmer will write a specified signature into a specified address of a specified memory layer of a target device in accordance to the parameters below.  This field reserves a maximum length of the signature string in the number of characters.
<b>Use Signature String template:</b>	One of two toggled radio buttons. If checked, the string pattern visible in the <b>Template String Specifiers</b> drop down menu box will be programmed into the target device.
<b>Use script to create Signature String:</b>	This radio button sets an alternative method of composing the signature string by means of a custom made script.
<b>Template String Specifiers:</b>	This window lists the parameters (specifiers) to be placed into the <b>Use Signature String template</b> field above as you wish they would be written into the device. Each parameter starts with the symbol '\$'.

## 4.1.3.4.3.5 Custom Shadow Areas

The dialog specifies a procedure of writing a user-defined data into the target device. A user can specify an unlimited number of custom shadow areas. The data can be either entered manually or built by a [script](#).

## 4.1.3.4.3.6 Overlapping data specified in shadow areas

Before [programming](#) a device the ChipProgUSB merges: a) the data loaded to buffers and b) special data set in the shadows areas and then writes the merged data array into the target memory device. If some addresses of the merged data overlap each other then the data taken from the shadow areas overwrite ones taken from the memory buffer as it is shown below:

---

Custom shadow area N ?  
 Custom shadow area N-1 ?  
 Custom shadow area N-2 ?  
 ....  
 ....  
 Custom shadow area 2 ?  
 Custom shadow area 1 ?

---

Signature string ?

---

Checksum ?

---

Serial Number ?

---

**Data in memory buffer**

---

**Note! It is important to carefully check correctness of the addresses set in the the Serialization, Checksum and Log File dialog to prevent spoiling data in the mistakenly overlapped areas!**

#### 4.1.3.4.3.7 Log file

The dialog allows set up of a log or logs of the device programming.

Element of dialog	Description
<b>Enable log file</b>	Checking this box enables logging the device programming sessions and setting the log parameters below:
<b>Separate log file for each device</b>	These two toggled radio buttons set if the logs will be separated by a manufacturer or by the target device type or a single log that will be kept for all the devices being programmed.
<b>File Name (Generated Automatically)</b>	Another two toggled radio buttons that set what specifier will be included into the log file name: both the manufacturer and device type (for example: Atmel AT89C51, Microchip PIC18F2525, etc.) or just the device type (for example: AT89C51, PIC18F2525, etc.).
<b>Folder for log file:</b>	This is a field for entering a full path to the folder where the log file will be kept. There is also a button for the path browsing.
<b>Single log file for all device types</b>	By checking this radio button you select keeping one common log for all types of the devices being programmed.
<b>File Name</b>	This is a field for entering a full path to the folder where the common log file will be kept. There is also a button for the path browsing.
<b>Log File Contents</b>	A set of the log file options.
<b>Gang mode: Socket #</b>	If the device programming was conducted in the Gang (multiprogramming) mode and if this box is checked the socket number will be logged.
<b>Date/Time</b>	By checking this box you enable logging the date and time of the device programming.

<b>Events (device type change, file names, etc.)</b>	By checking this box you enable logging of all the events associated with the device programming, e.g. the target device replacement, loaded file names, etc.
<b>Device operation</b>	By checking this box you enable logging of all the events associated with the device manipulations.
<b>Detailed Device operation</b>	By checking this box you enable more detailed logging of all the events associated with the device manipulations.
<b>Operation Result</b>	By checking this box you enable logging the results of the programming operations.
<b>Device #/Good devices/Bad devices</b>	By checking this box you enable logging a full number of the devices programmed, number of successfully programmed devices and number of failed ones.
<b>Serial Number</b>	By checking this box you enable logging the serial number read from the device.
<b>Signature string</b>	By checking this box you enable logging the signature string read from the device.
<b>Checksum</b>	By checking this box you enable logging the checksum value read from the device.
<b>Buffer name</b>	By checking this box you enable logging the buffer name.
<b>Programming address</b>	By checking this box you enable logging the ranges of the device locations which have been programmed.
<b>Programming options</b>	By checking this box you enable logging all the programming options.
<b>Log File Format</b>	A pair of toggled radio buttons: one sets the plain text format of the log file, the second sets the tabulated text to be viewed in the Microsoft Excel format.
<b>Log File Overwrite Mode</b>	A pair of toggled radio buttons, checking the top one sets the mode of appending new records to a specified log file and checking the second overwrites the old log every time the ChipProg re-starts.
<b>Warn if size exceeds</b>	If this box is checked then every time when the log size exceeds a user-specified value the ChipProgUSB issues a warning.
<b>Immediately write log file to disk, no buffering</b>	If this box is checked then the ChipProgUSB does not buffer the log to the computer RAM but writes it straight to the drive.

#### 4.1.3.4.4 The Preferences dialog

This dialog gathers settings for some miscellaneous options.

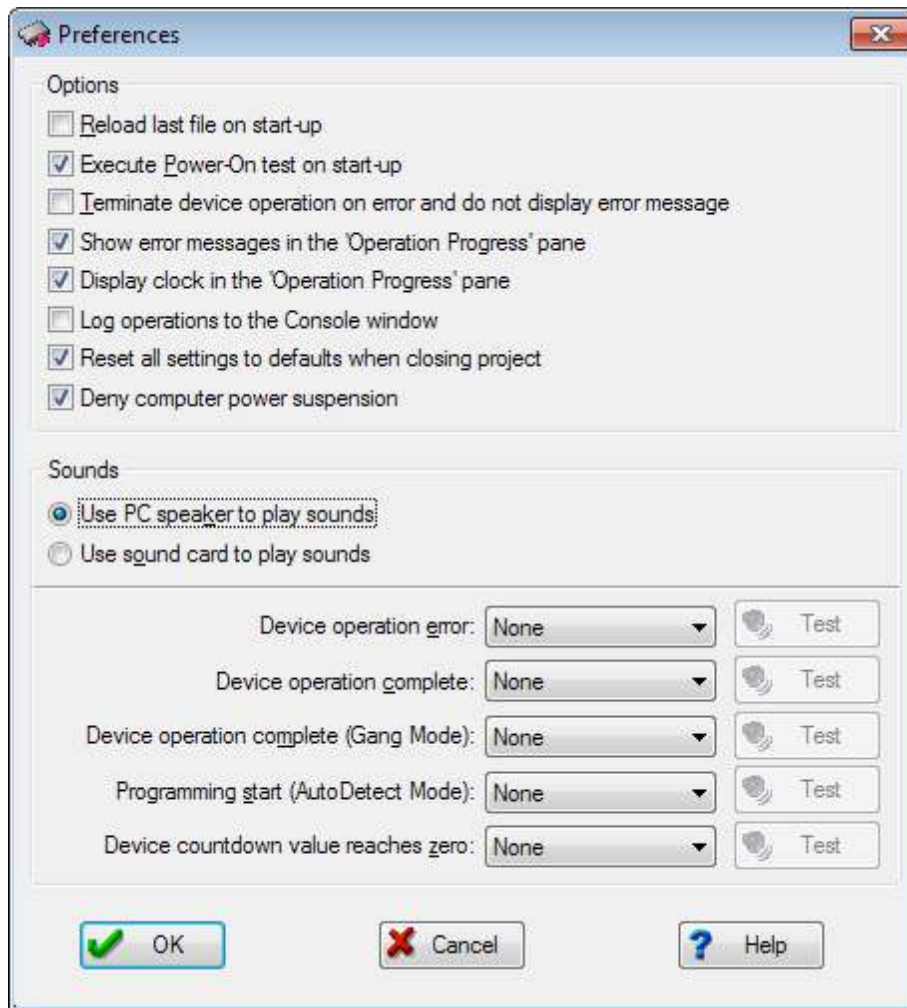

Element of dialog	Description
<b>Options</b>	Not all the dialog options are described here.
<b>Reload last file on start-up</b>	By checking this box you enable re-loading to the open buffer(s) the last loaded file every time when you start the ChipProg.
<b>Execute Power-On test on start-up</b>	This box is checked by default. By un-checking this box you skip executing the start-up ChipProg self-testing
<b>Terminate device operation...</b>	By checking this box you stop the programmer operations operations on any error and suppress displaying error messages in the user interface.
<b>Log operations in the Console window</b>	By checking this box you enable dumping the programming session trace to the Console window.
<b>Deny computer power suspension</b>	While the programmer does not operate with the target device the computer may switch to the sleep mode. By checking this box you

disable Windows to enter the sleep mode. This does not protect a PC against falling asleep when an operator intentionally closes a notebook lid or intentionally shut down the computer by pressing the button Start > Shut down. This option neither blocks a screen saver nor disable switching off the monitor power.

While the ChipProg executes any command on the target device falling PC asleep is disabled regardless of the check box status because switching power of the USB port may cause destroying a target device.

If this check box is unchecked then waking up the computer will cause the ChipProgUSB software crashes. If the crash happens it is necessary to cycle the ChipProg power and to launch the ChipProgUSB application.

<b>Sounds</b>	All programmable sounds can be picked from the preset ChipProgUSBsounds
<b>Device operation error:</b>	Select the sound for error operations.
<b>Device operation complete:</b>	Select the sound for successful completion of the programming operations in a single programming mode (one ChipProg is in use).
<b>Device operation complete (Gang Mode):</b>	Select the sound for successful completion of the programming operations in a gang programming mode (either a few single site programmers are connected to one PC for multi-device programming or when the ChipProg gang programmer is in use).
<b>Programming start (AutoDetect Mode):</b>	Select the sound for indicating the start of the device programming when the ChipProg automatically detects the device insertion into the programming socket.

#### 4.1.3.4.5 The Environment dialog

The Environment dialog includes the following tabs:

[Fonts](#) tab,

[Colors](#) tab,

[Mapping Hot Keys](#) tab,

[Toolbar](#) tab,

[Miscellaneous Settings](#) tab.

#### 4.1.3.4.5.1 Fonts

The **Fonts** tab of the **Environment** dialog opens a sub dialog for setting fonts and some appearance elements in the ChipProgUSB windows. Only mono-spaced (non-proportional) fonts (default is Fixedsys) are used to display information in windows. To improve appearance of the windows, you can set up either another font for all windows, or individual fonts for each particular window.

The **Windows** area lists the types of windows. Select a type to set up its options. The set options are

valid for all windows of the selected type, including the already opened windows.

<u>Element of dialog</u>	<u>Description</u>
<b>Window Title Bar</b>	Toggles the title bar for windows of the selected type. If the box is checked it adds a toolbar at the position specified by the <b>Windows Toolbar Location</b> option. To save screen space uncheck the box. Also, see notes below.
<b>Window Toolbar Location</b>	Sets the toolbar location for the selected window.
<b>Grid</b>	Turns on/off the display of the vertical and horizontal grids in some window types, and permits adjusting the column width (when the vertical grid is allowed).
<b>Additional Line Spacing</b>	Provides additional line spacing, which will be added to the standard line spacing. Supply a new value or choose from the list of most recently used values.
<b>Define Font</b>	Opens the <b>Font</b> dialog. The selected font is valid for all windows of the selected type.
<b>Use This Font for All Windows</b>	Applies the font of the chosen window type to all ChipProgUSB windows.

#### Notes

- To move a window without the title bar, place the cursor on its toolbar, where there are no buttons, and then operate as if the toolbar were the window title bar. Also, you can access the window control functions through its system menu by pressing the **Alt+<grey minus>** keys.
- Each window has the **Properties** item in its local menu, which can be invoked by a right click. The **Title** and **Toolbar** items of the **Properties** sub-menu toggle the title bar and toolbar on/off for the individual active window.

#### 4.1.3.4.5.2 Colors

The **Colors** tab of the **Environment** dialog opens a sub dialog for setting colors of such window elements as window background, font, etc.. By default, most colors are inherited from MS Windows; however you can set other colors if you prefer them.

<u>Element of dialog</u>	<u>Description</u>
<b>Color Scheme</b>	Specifies the color scheme name. You can type in a name or choose a recently used one from the list.  The <b>Save</b> button saves the current scheme to the disc; later you can restore color settings by just a mouse click. The <b>Remove</b> button removes the current scheme.
<b>Colors</b>	Lists the names of color groups. Each group consists of several elements.
<b>Inherit Windows Color</b>	When this box is checked, the selected color is taken from MS Windows. If later you change the MS Windows colors through the Windows Control Panel, this color will change accordingly. This option is available only for the background and text colors.
<b>Use Inverted Text/ Background Color</b>	When this box is checked, the program inverts the selected window colors (for text and background). For example, if the <b>Watches</b> window background color is white and the text color is black, then the line with the selected



	variable will be highlighted with black background and white text.
<b>Edit</b>	Opens the <b>Color</b> dialog if the <b>Inherit Windows Color</b> and <b>Use Inverted Text/Background Color</b> boxes are unchecked for this type of window.  The <b>Color</b> dialog also opens if you double-click a color in the <b>Colors</b> list.
<b>Spread</b>	Sets the selected color for all windows. This option is useful for text and background colors. For example, if you choose blue background and yellow text for the <b>Source</b> window and then click the <b>Spread</b> button, these colors will be set as the text and background colors for all windows.
<b>Font</b>	For syntax highlighting in the <b>Source</b> window, you can specify additional font attributes - Bold and Italic.  In some cases when synthesizing bold fonts, MS Windows increases the size of characters and the font becomes unusable, because the bold and regular characters should be of the same size. In these cases, the Bold attribute is ignored.  Sometimes this effect occurs with the Fixedsys font. If you need to use Bold fonts, choose the Courier New font.

#### 4.1.3.4.5.3 Mapping Hot Keys

The **Key Mapping** tab of the **Environment** dialog opens a sub dialog for assigning hot keys for all commands in the ChipProgUSB. The **Menu Commands Tree** column displays a tree-like expandable diagram of all commands. The **Key 1 (Key 2)** columns contain the corresponding hot-key combinations for the commands. The actions apply to the currently selected command.

<u>Element of dialog</u>	<u>Description</u>
<b>Define Key 1</b> <b>Define Key 2</b>	Opens the <b>Define Key</b> dialog. In the dialog, press the key combination you want to assign to the selected command, or press <b>Cancel</b> . Alternatively, double-click the "cell" in the row of this command and the <b>Key 1 (Key 2)</b> column.
<b>Erase Key 1</b> <b>Erase Key 2</b>	Deletes the assigned key combination from the selected command. Alternatively, right click the "cell" in the row of this command and the <b>Key 1 (Key 2)</b> column.

#### 4.1.3.4.5.4 Toolbar

The **Toolbar** tab of the **Environment** dialog controls the presence and contents of toolbars of the windows.

<u>Element of dialog</u>	<u>Description</u>
<b>Toolbar Bands</b>	Lists the ChipProgUSB toolbars. To enable/disable a toolbar check its box.
<b>Buttons/Commands</b>	Lists the buttons for the toolbar selected in the <b>Toolbar Bands</b> list. To enable/disable a button on the toolbar check its box.
<b>"Flat" Local Window Toolbars</b>	Toggles between the "flat" and quasi-3D appearance of the local toolbar buttons for the specialized windows.
<b>Toolbar Settings are the Same for Each Project/Desktop File</b>	Employs the current settings from this dialog for other projects or files opened later.

#### 4.1.3.4.5.5 Messages

Check messages that program should display, uncheck messages that you do not want to be displayed.

#### 4.1.3.4.5.6 Miscellaneous Settings

The **Miscellaneous** tab of the **Environment** dialog allows the setting of miscellaneous parameters of the ChipProgUSB windows and messages.

<u>Element of dialog</u>	<u>Description</u>
<b>Main Window Status Line</b>	Controls presence and location of the <%CM%> window status line.
<b>Quick Watch Enabled</b>	Turns the <a href="#">Quick Watch function</a> on or off.
<b>Highlight Active Tabs</b>	Turns highlighting on/off for the currently active tab (the MS Windows-style) in windows that have tabs.
<b>Double Click on Check Box or Radio Button in Dialogs</b>	Sets the mouse's double click function equal to a single click, plus pressing the <b>OK</b> button in that dialog.
<b>Show Hotkeys in Pop-up Descriptions</b>	Turns the Hotkeys display on/off in the short prompts for toolbar buttons.
<b>Do not Display Box if Console Window Opened</b>	If the <a href="#">Console</a> window is open, messages will be displayed there. Otherwise, the message box will display messages.
<b>Always Display Message Box</b>	All issued messages will be displayed in the message box. The <b>Console</b> window also displays these messages.
<b>Automatically Place Cursor at OK Button</b>	The cursor will always be on the <b>OK</b> button when the message box opens and this box is checked.  If you prefer you may press the <b>Enter</b> key instead of using the mouse to click <b>OK</b> .
<b>Audible Notification</b>	If you select this option, there will be a beep along with the error message.

<b>for Error Messages</b>	Information (as opposed to error) messages are always displayed without the beep.
<b>Log Messages to File</b>	Specifies the log file name. All messages will be written to this file. The method of writing is controlled by the radio button with two options:
<b>Overwrite Log File After Each Start</b>	Specifies erasing the previous log file, if it exists, and creates it afresh for every session.
<b>Append Messages to Log File</b>	Specifies appending messages to the end of an existing log file. In this case, the log file size will grow endlessly.

#### 4.1.3.4.6 Configuring Editor Dialog

The ChipProgUSB software includes a **built-in editor** that is used for editing one type of the objects of the ChipProgUSB - [Scripts Files](#). The **Editor Options dialog** includes the following tabs:

[General Editor Settings](#) tab,

[Key Mapping](#) tab.

##### 4.1.3.4.6.1 General Editor Settings

The **General** tab of the **Editor Options** dialog sets up all common options applicable to every [Source](#) window opened.

<b><u>Element of dialog</u></b>	<b><u>Description</u></b>
<b>Backspace Unindents</b>	Checking/clearing this box toggles the Backspace Unindent mode. See below for explanations.
<b>Keep Trailing Spaces</b>	When this box is checked, the editor does not remove trailing spaces in lines when copying text to the buffer or saving it to a disk. Spaces are removed when the box is unchecked.
<b>Vertical Blocks</b>	If the box is checked, the Vertical Blocks mode is enabled for <a href="#">block operations</a> .
<b>Persistent Blocks</b>	If the box is checked, the Persistent Blocks mode is enabled for block operations.
<b>Create Backup File</b>	If the box is checked then <%CM%> creates a *.BAK file each time a file is saved in the <b>Source window</b> .
<b>Horizontal Cursor</b>	If the box is checked it sets the cursor as a horizontal line, like the DOS command prompt.
<b>CR/LF at End-of-file</b>	If the box is checked, it adds an empty line to the file end when saving the file to disk (if there is no one yet).
<b>Syntax Highlighting</b>	If the box is checked, it forces <a href="#">syntax highlighting</a> of language constructions.

<b>Highlight Multi-line Comments</b>	If the box is checked it enables highlighting of multi-line comments. By default, the window highlights only single-line comments.
<b>Auto Word/AutoWatch Pane</b>	If the box is checked, any new <a href="#">Source</a> window will open with the <b>Auto Word/AutoWatch</b> pane at its right and <i>the automatic word completion function</i> will be enabled.
<b>Full Path in Window Title</b>	If the box is checked, the <b>Source</b> window caption bar displays the full path to the opened file.
<b>Empty Clipboard Before Copying</b>	If the box is unchecked, then previously kept data remains retrievable after copying to the clipboard.
<b>Convert Keyboard Input to OEM</b>	If the box is checked, the <b>Source</b> window converts the characters that you input in the window from the MS Windows character set to the OEM (national) character set corresponding to your national version of the Windows operating system. Also, see note below.
<b>AutoSave Files Each ... min</b>	If the box is checked, <%CM%> will save the file being edited every 'X' minutes, where 'X' is a settable constant chosen by the user.
<b>Tab Size</b>	Sets the tabulation size for the text display. The allowable value ranges from 1 to 32. If the file being edited contains ASCII tabulation characters, they will be replaced with a number of spaces equivalent to the tabulation size.
<b>Undo Count</b>	Sets the maximum number of available undo steps (512 by default). If this does not suffice, you can set a value of up to 10000 steps. However, larger values increase the editor's memory requirement.
<b>Automatic Word Completion</b>	If the <b>Enable</b> box is checked, it allows the <a href="#">automatic word completion</a> function. The <b>Scan Range</b> drop-down list sets the number of text lines to be scanned by the automatic word completion system.
<b>Indenting</b>	Toggles automatic indenting on/off for a new line that is created when you press <b>Enter</b> .

**Note.** You should check the **Convert Keyboard Input to OEM** box only if you are going to type something in the **Source** window when working with a file coded in the OEM character set. If you need only to display such a file, specify the Terminal font for the **Source** window in the [Fonts](#) tab of the **Environment** dialog: select **Editor** in the **Windows** list and press the **Define Font** button.

The **Backspace Unindent** mode establishes the editing result from pressing the **Backspace** key in the following four cases, when the cursor is positioned at the first non-space character in the line (there are several spaces between the first column of the window and the first non-space character):

	<a href="#">Backspace Unindent enabled</a>	<a href="#">Backspace Unindent disabled</a>
<a href="#">Insert mode</a>	Any preceding blank spaces in the line are deleted. The rest of the line shifts left until its first character is in the first column of the window.	One space to the left of the cursor is deleted. The cursor and the rest of the line to the right of the cursor shift one position left.
<a href="#">Overwrite mode</a>	The cursor moves to the first column of the window. The text in the line remains in place.	Only the cursor moves one position left. The text in the line remains in place.

#### 4.1.3.4.6.2 The Editor Key Mapping

You can manage the list of available editor commands with the **Key Mappings** tab of the **Editor Options** dialog. You can add and delete editor commands, assign (or reassign) hot keys for new commands and for built-in ones.

The left column of the list contains command descriptions. Command types, corresponding to the command descriptions, are in the second column. (*Command* means a built-in ChipProgUSB command; *Script 'XXX'* means an added user-defined command). Two columns on the right specify the hot key combinations to invoke the command, if any.

<b><u>Element of dialog</u></b>	<b><u>Description</u></b>
<b>Add</b>	Opens the <a href="#">Edit Command</a> dialog for adding a new command to the list and setting up the command parameters.
<b>Delete</b>	Removes a selected user-defined command from the list. Any attempt to remove a built-in command is ignored.
<b>Edit</b>	Opens the <b>Edit Command</b> dialog to change the command parameters. For built-in commands, you can only reassign the hot keys (the <b>Command Description</b> and <b>Script Name</b> boxes are not available).
<b>Edit Script File</b>	Opens the script source file of this command in the <a href="#">Script Source</a> window.

#### **Creating new commands**

To create a new command, you should develop a script for it. In fact, you add this script to the editor, not the command. This means that your command is able to perform much more complex, multi-step actions than a usual editor command. Moreover, you can tailor this action for your convenience, or for a specific work task or other need. Your scripts may employ the capabilities of the script language with its entire set of built-in functions and variables, text editor functions and existing script examples.

A script source file is an ASCII file. To execute your command, the editor compiles the script source file. Note that before you can switch to using the script which you have been editing, you must first save it to the disk so that ChipProgUSB can compile it.

Script source files for new commands will reside only in the KEYCMD subdirectory of the ChipProgUSB system folder. Several script example files are available in KEYCMD. For more information about developing scripts, see [Script Files](#).

This dialog **Edit command** sets parameters for a new command or for existing ones.

<b><u>Element of dialog</u></b>	<b><u>Description</u></b>
<b>Command Description</b>	Enter the command description here (optional). Text placed in this box will be displayed in the list of commands for easier identification of the command.
<b>Script Name</b>	The name of the script file that executes this command.
<b>Define Key 1</b> <b>Define Key 2</b>	Opens the specialized dialog box where you can assign two key combinations to a couple of hot keys.

The script source files for commands will reside only in the KEYCMD subdirectory of the ChipProgUSB system folder. Enter the file name only, without the path or extension.

#### Notes

1. You should not specify the combinations reserved by Windows (like **Alt+—** or **Alt+Tab**).
2. We do not recommend assigning the combinations already employed by commands in the **Source** window or ChipProgUSB, because then you'll have fewer ways to access these commands. Some examples are **Alt+F**, **Shift+F1**, **Ctrl+F7**, which are commands that open the application menus. Others are the local menu hot keys of the editor window.
3. You can use more than one control key in the keystroke combinations. For example, you can use **Ctrl+Shift+F** or **Ctrl+Alt+Shift+F** as well as the **Ctrl+F** combination.
4. For some built-in commands, the hot keys cannot be reassigned (for example, the keys for moving the cursor).

#### 4.1.3.5 The Commands Menu

This menu invokes main commands (or functions) that control the programming process, as well as some service commands.

<u>Command</u>	<u>Description</u>
<b>Blank Check</b>	This command invokes the procedure of checking the target device before programming to make sure that it is really blank. Programming of some memory devices does not require erasing them before re-programming. For such devices the <b>Blank Check</b> command is blocked and it is shown grayed out on the screen.
<b>Program</b>	This command invokes the procedure of programming the target device, e.g. writes the contents of the buffer into the target device's cells.
<b>Verify</b>	This command invokes the procedure of comparing the information taken from the target device with the corresponding information in the buffer.
<b>Read</b>	This command invokes the procedure of reading the content of the target device's cells into an active buffer.
<b>Erase</b>	This command invokes the procedure of erasing the target device. Some memory devices cannot be electrically erased. In this case the Erase command is blocked and is grayed out on the screen.
<b>Auto Programming</b>	This command invokes the procedure of <a href="#">AutoProgramming</a> .
<b>Local menu</b>	Opens the local menu of active window.
<b>Calculator</b>	Opens the <a href="#">Calculator</a> dialog, which performs calculator functions.

##### 4.1.3.5.1 Calculator

A prime purpose of the embedded calculator is to evaluate [expressions](#) and to convert values from one radix to another. You can copy the calculated value to the clipboard.

<b>Element of dialog</b>	<b>Description</b>
<b>Expression</b>	The text box for entering an expression or number.
<b>Copy As</b>	Specifies the format of results that will be copied to the clipboard.
<b>Signed Values</b>	If this box is checked the result of a calculation will be interpreted and displayed as a signed value (for the decimal format only).
<b>Display Leading Zeroes</b>	If this box is checked, binary and hexadecimal values retain leading zeroes.
<b>Copy</b>	Copies the result to the clipboard in the format set by the <b>Copy As</b> radio button.
<b>Clr</b>	Clears the <b>Expression</b> text box.
<b>Bs</b>	Deletes one character (digit) to the left of the insertion point (Backspace).
<b>0x</b>	Inserts "0x".
<b>&gt;&gt;</b>	Shifts the expression result to the right by the specified number of bits.
<b>&lt;&lt;</b>	Shifts the expression result to the left by the specified number of bits.
<b>Mod</b>	Calculates the remainder of division by the specified number.

While you are typing the expression in the **Expression** drop-down list box ChipProgUSB tries to evaluate the expression and immediately displays the result in different formats in the **Result** area. Statuses of the **Copy As** radio button and two check boxes in this area control the result format.

You can assign values to program variables and SFRs by typing an expression that contains the assignment. For example, you may type `SP = 66h` and the value of 66h will be assigned to SP.

**Examples of expressions:**

```
0x1234
-126
main + 33h
(float) (*ptr + R0)
101100b & 0xF
```

#### 4.1.3.6 The Script Menu

The ChipProgUSB is featured with the tools known as an embedded script language. This mechanism is intended for automation of the programming operation, mastering complex operations that include both the programmer itself and the programmer operator's actions. The ChipProgUSB enables composing scripts

files (SF) and executing them.

This Script menu contains a few commands associated with script files. The commands can be configured by the ChipProg user and the list can be expanded by adding a new item (command). To add a new item, place a script file into the current folder or into the ChipProgUSB installation folder. The first non-empty line of any script file should contain three slashes followed by the text that will appear in the **Scripts** menu:

```
/// Menu item text
```

When ChipProgUSB builds the **Scripts** menu, it searches the current folder and its installation folder for all \*.CMD files that contain '///' in the first line (remember that '/' denotes the beginning of the single-line comment) and inserts the text following '///' into the **Scripts** menu.

When you select a **Scripts** menu item and click the **Start** button, ChipProgUSB launches the selected script.

Button	Command	Description
	<b>Start...</b>	Opens the <a href="#">Script Files</a> dialog from which you can
	<b>New Script Source</b>	Create a new <b>Script File</b> text.
	<b>Open Watches window</b>	Opens the <a href="#">Watches</a> window.
	<b>Add watch...</b>	Add watch to the <b>Watches window</b> .
	<a href="#">Editor window</a>	Opens a list of the commands to <b>Compose a new, Open, Save, Save as, Print</b> a script file. of the <a href="#">Editor</a> window.
	<a href="#">Text Edit</a>	Edit a list of the commands for editing a selected <b>Script File</b>
	<b>Example Scripts</b>	Invokes the
	<b>Help on this menu</b>	

Working with scripts is describe in the [Script files](#) topics.

#### 4.1.3.7 The Window Menu

This menu lets you control how the windows are arranged within the computer screen. The list of currently opened windows is shown in the lower part of the menu. By choosing a particular window name in this list you immediately activate it and bring it to the foreground of the computer screen.

<u>Command</u>	<u>Description</u>
<b>Title</b>	Arranges all windows without overlap. Makes the window sizes approximately equal.
<b>Tile Horizontally</b>	Arranges the windows horizontally without overlap. Makes the window size as close to each other as possible.
<b>Cascade</b>	Cascades the windows.
<b>Arrange Icons</b>	Arranges the icons of the minimized windows.
<b>Close All</b>	Closes all windows.



#### 4.1.3.8 The Help Menu

This menu gives access to the help system. See also, [How to Get On-line Help](#).

<u>Command</u>	<u>Description</u>
<b>Contents</b>	Opens the contents of the help file.
<b>Search for Help on</b>	Opens the dialog for searching the tool's help system for the content, index and keywords.
<b>Phyton Adapters</b>	Opens the HTML file, which includes adapters' part numbers, their short descriptions and wiring diagrams.
<b>Visit Phyton website</b>	Open the <a href="http://www.phyton.com">www.phyton.com</a> site in your default Internet browser.
<b>Check for updates</b>	Opens the <b>Update Checking</b> dialog that directly links your computer to the Phyton download webpage.
<b>Send e-mail message to Phyton</b>	Opens the default email client to compose a message to Phyton.
<b>About ChipProg</b>	The box displays: the ChipProgUSB and the ChipProg Windows shell software version numbers; the selected target device type and the device manufacturer.

#### 4.1.4 Windows

The ChipProgUSB enables opening the following types of windows by means of the [View menu](#):

- [Program manager](#)
- [Device and Algorithm Parameters' Editor](#)
- [Buffer](#)
- [Device Information](#)
- [Console](#)

Plus it can operate with two types of windows associated with the ChipProgUSB script files:

- Editor
- Watches

##### 4.1.4.1 The Program Manager Window

The **Program Manager window** is the major control object on the screen from which an operator controls the ChipProg . While some windows can be closed in a process of programming this one is supposed to be always open and visible.

The window includes three tabs opening three group of settings and status indicators:

### [The Program Manager tab](#)

### [The Option tab](#)

### [The Statistics tab](#)

The **Project Manager** and **Options** tabs look different and enable different settings for the ChipProg programmers working in single-programming and multi-programming modes. These tabs are identical for the ChipProg-G41 gang programmer and for the ChipProg-48, ChipProg-40 and ChipProg-ISP programmers when they are configured to work in the multi-programming mode.

#### 4.1.4.1.1 The Program Manager tab

The tab serves for setting major programming parameters, executing the programming operations and displaying the ChipProg statuses.

Element of dialog	Description
<b>Buffer:</b>	The field <b>Buffer</b> displays the active buffer to which the programming operations (functions) will be applied. A full list of open buffers is available here via the drop-down menu.
<b>Functions</b>	This field lists the tree of the functions relevant to the selected target device. Some functions represent the ChipProg commands while others integrate a few sub-functions and can be expand or collapsed. Double clicking on the function invokes the command and is equivalent to single clicking the <b>Execute</b> button (see below).
<b>Blank check</b>	Checks if the target device is blank
<b>Program</b>	Programs the target device (writes the information from an active buffer to the target device).
<b>Read</b>	Reads out the content of the target device to an active buffer.
<b>Verify</b>	Compares the content of the target device and an active buffer

<b>Auto Programming</b>	Executes a preset sequence of operations (batch operations) settable in the <a href="#">Auto Programming</a> dialog. The <b>Edit Auto</b> button opens this dialog.
<b>Addresses</b>	Here you can set the addresses for the buffer and the target device to which the programming functions will be applied.
<b>Device start:</b>	The very first address in the target device's physical memory which will be programmed or read.
<b>Device end:</b>	The very last address in the target device's physical memory which will be programmed or read.
<b>Buffer start:</b>	The very first address in the buffer memory from which the data will be written to the target device or to which the data will be read from the device.
<b>Execute</b>	There are three alternative ways to activate a highlighted function: a) to click the <b>Execute</b> button; b) to double click on the function line; c) to push the <b>Enter</b> button on the PC keyboard.
<b>Repetitions:</b>	Any function can be executed repeatedly. The number of repetitions can be set here.
<b>Edit Auto</b>	Clicking on this button opens the <a href="#">Auto Programming</a> dialog.
<b>Operation Progress</b>	In this field the ChipProgUSB displays the current operation progress bar and the operation status (OK, failed, etc.).

Besides the generic functions (**Blank Check, Read, Verify, Program, Auto Programming**) the window **Functions** often includes collapsed submenu for the functions specific for a selected target device. Being expanded these functions list commands for the parameters settable in the [Device and Algorithm Parameters](#) editor window.

#### **IMPORTANT NOTE!**

Any changes made in the 'Device and Algorithm Parameters' window do not *immediately* cause corresponding changes in the target device. Parameter settings made within this window just prepare a configuration of the device to be programmed. Physically, the programmer makes all these changes only upon executing an appropriate command from the 'Program Manager' window.

##### 4.1.4.1.1.1 Auto Programming

Each device has its own routine set of programming operations that usually includes: **Erasing, Blank Checking, Programming, Verifying** and often **Protecting** against unauthorized reading. The ChipProgUSB stores default batches of these programming operations for each single supported device and allows the invocation of the batch of operations just by a mouse click or pressing the Start button on the programmer panel. It also enables the customization of a sequence of elementary functions (operations) via the **Auto Programming** dialog. To open this dialog click on the **Edit Auto** button.

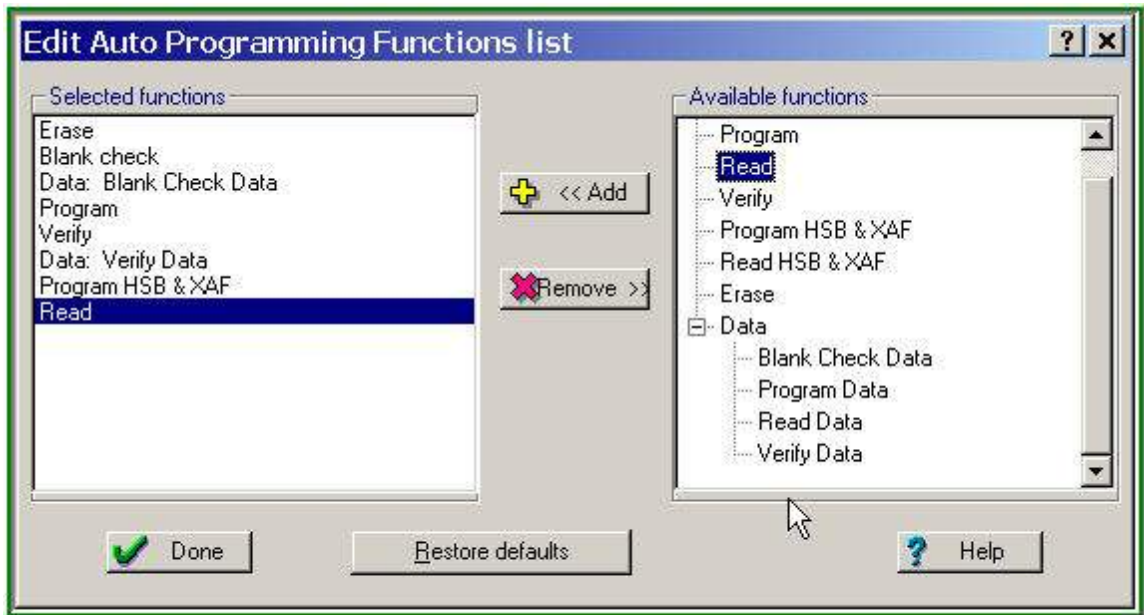

Adding a Command to the Auto Programming Function List

The tree including all the functions available for the chosen target device is shown in the right pane **Available functions**. To include a function to the batch highlight it in the right pane and click the **Add** button - the function will appear in the left pane **Selected functions**. The functions will be then executed in the order in which they are positioned in the **Selected functions** pane, from the top to the bottom. To correct the function batch highlight the command to be removed and click the **Remove** button.

#### 4.1.4.1.2 The Options tab

The tab serves for setting additional programming parameters and options:

Element of dialog	Description
<a href="#">Split data</a>	The group of radio buttons in the <b>Split data</b> field allows the programming of 8-bit memory devices to be used in the microprocessor systems with the 16- and 32-bit address and data buses. To do this the buffer content should be properly prepared to split one memory file into several smaller file.
<b>Options</b>	
<b>Insert test</b>	If this box is checked the ChipProgUSB will test whether each of the device leads is reliably squeezed by the programming socket contact. If some contact is bad a current operation will be blocked.
<b>Check device ID</b>	By default this option is always on and the ChipProg always verifies the target device identifier given by the device

	manufacturer. If the box is unchecked the program will skip the device ID checking.
<b>Reverse bytes order</b>	If this box is checked the ChipProgUSB will sweep the byte order in the 16-bit word while it executes the <b>Read</b> , <b>Program</b> and <b>Verify</b> operations. This option does not affect the data in the ChipProg buffers, as they remain the same after the file loading.
<b>Blank check before program</b>	If this box is checked the ChipProgUSB will always check if the target device is blank before programming it.
<b>Verify after program</b>	If this box is checked the ChipProgUSB will always verify the device content right after it was programmed.
<b>Verify after read</b>	If this box is checked the ChipProgUSB will always verify the device content right after it was read out.
<b>Auto-Detect presence of device in the socket</b>	If this box is checked the ChipProgUSB will test whether each of the device leads is reliably squeezed by the programming socket contact. If so a preset programming function (operation) or <a href="#">Auto Programming</a> will start. Otherwise, if some contact is bad a current operation will be blocked.
<b>On Device Auto-Detect or 'Start' Button:</b>	The group of radio buttons. The checked radio button defines what the ChipProg will do upon the the drive auto-detect or pushing the 'Start' button.

#### 4.1.4.1.2.1 Split data

The group of radio buttons in the [Option](#) tab in the **Split data** field allows programming 8-bit memory devices to be used in the microprocessor systems with the 16- and 32-bit address and data buses. To do so the buffer content should be properly prepared to split one memory file into several smaller files. The data splitting enable the conversion of the data read from 16- or 32-bit devices to make file images for writing them to memory devices with the byte organization.

Radio button	Description
<b>No split</b>	This is a default option. A whole buffer is not split and is considered as a whole one byte data array.
<b>Even byte</b>	The data in the buffer are considered as an array of 16-bit words. The buffer-device operations are conducted with <b>even bytes only</b> . For example, if the programmer reads the device from the address=0, the byte with this address will be placed to the buffer location also with the address=0, the byte from the device with the address=1 will be placed to the buffer location with the address=2, etc.
<b>Odd byte</b>	The data in the buffer are considered as an array of 16-bit words. The buffer-device operations are conducted with <b>odd bytes only</b> . For example, if the programmer reads the device from the

address=0, the byte with this address will be placed to the buffer location also with the address=1, the byte from the device with the address=1 will be placed to the buffer location with the address=3, etc.

**Byte 0**

The data in the buffer are considered as an array of 32-bit words. The buffer-device operations are conducted with **the byte #0 only**. For example, if the programmer reads the device from the address=0, the byte with this address will be placed to the buffer location also with the address=0, the byte from the device with the address=1 will be placed to the buffer location with the address=4, etc.

**Byte 1**

The data in the buffer are considered as an array of 32-bit words. The buffer-device operations are conducted with **the byte #1 only**. For example, if the programmer reads the device from the address=0, the byte with this address will be placed to the buffer location with the address=1, the byte from the device with the address=1 will be placed to the buffer location with the address=5, etc.

**Byte 2**

The data in the buffer are considered as an array of 32-bit words. The buffer-device operations are conducted with **the byte #2 only**. For example, if the programmer reads the device from the address=0, the byte with this address will be placed to the buffer location with the address=2, the byte from the device with the address=1 will be placed to the buffer location with the address=6, etc.

**Byte 3**

The data in the buffer are considered as an array of 32-bit words. The buffer-device operations are conducted with **the byte #3 only**. For example, if the programmer reads the device from the address=0, the byte with this address will be placed to the buffer location with the address=3, the byte from the device with the address=1 will be placed to the buffer location with the address=7, etc.

#### 4.1.4.1.3 The Statistics tab

This tab opens the file displaying the programming session statistical results - **Total** number of devices that were programmed during the session, what was the yield (**Good**) and how many devices have failed (**Bad**). Getting such statistics is quite helpful when you need to program a series of same type devices. It is important to remember that the statistical counters are affected by executing the [Auto Programming](#) only, as execution of other functions makes no effect on the statistics.

Element of dialog	Description
<b>Clear statistics</b>	This button resets the statistics..
<b>Device Programming Countdown</b>	Normally the <b>Total</b> counter increments after each <a href="#">Auto Programming</a> ; the , <b>Good</b> and <b>Bad</b> counters also count up. The ChipProgUSB reverses the counters to decrement their content (to count down).
<b>Enable countdown</b>	If the box is checked the ChipProgUSB will count the number of the programmed devices down.
<b>Display message when countdown value reaches zero</b>	If the box is checked the ChipProgUSB will issue a warning when the counter <b>Total</b> is zeroed.
<b>Reset counters when countdown value reaches zero</b>	If the box is checked the ChipProgUSB will reset all the counters when the counter <b>Total</b> is zeroed.
<b>Count only successfully programmed devices</b>	If the box is checked the ChipProgUSB will count only the successfully programmed ( <b>Good</b> ). All other statistics will be ignored.
<b>Set initial countdown value</b>	Clicking on the button opens the box for entering a new <b>Total</b> number that then will be decremented after each <a href="#">Auto Programming</a> .

#### 4.1.4.2 The Device and Algorithm Parameters window

The **Device and Algorithm Parameters Editor** window is intended for displaying and editing (where possible) the device's internal parameters and settings, which after editing should be programmed into a target device by executing the [Program](#) command in the [Program Manager](#) window.

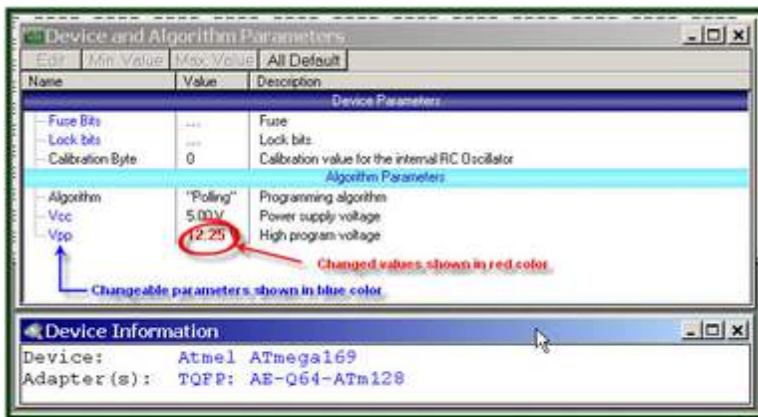

Device and Algorithm parameters

The parameters displayed into this window are split in two groups: **Device Parameters** and **Algorithm Parameters**. The groups are separated by a light blue stripe

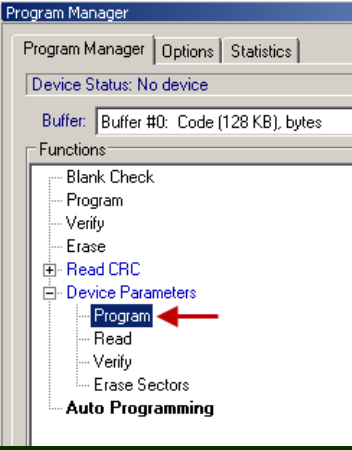
<p><b>Device Parameters</b></p>	<p>This group includes parameters that are specific for each selected device, such as: <b>sectors for flash memory devices, lock and fuse bits, configuration bits, boot blocks, start addresses</b> and other controls for microcontrollers. Usually these parameters represent certain bits in a microcontroller's Special Function Registers (SFRs). Some of these SFRs can be set in the ChipProg buffers in accordance with device manufacturers' data sheets. But setting the parameters in the <b>Device and Algorithms Parameters</b> window is much easier and more intuitive. It is impossible to specify absolutely all features that may appear in future devices, and, therefore, new parameters for these new devices.</p>
	<p><b>Important note!</b> Changing device parameters in the <b>Device and Algorithm Parameters Editor</b> window does not immediately cause corresponding changes inside the target device. While making the changes you just prepare a new configuration that is different from the default for the device to be programmed. Physically, the ChipProg makes the device parameter changes only when you execute the function <b>Program</b> in the <b>Device Parameters</b> group in the <b>Function</b> pane of the <b>Program Manager</b> window. See the picture at left.</p> 
<p><b>Algorithm Parameters</b></p>	<p>This group includes parameters of the programming algorithm for the selected device – including the algorithm type and editable programming voltages.</p>

The window is separated into three columns: 1) the parameter's name, 2) its value or setting, 3) a short description. **Names** of the editable parameters are shown in blue; other names are shown in black.



Default values in the column **Value** are shown in black; after changing a parameter the new value will be shown in red. If the value is too long to display the window represents it as three dot signs ('...'). If these dots are red it means that the parameter has been edited.

In order to edit a parameter, double click its name. Some editable parameters are represented by a set of check boxes, some require to be typed in prompt boxes.

The local **Device and Algorithm Parameters Editor** window's toolbar includes a few buttons positioned on the top of the window:

Toolbar button	Description
<b>Edit</b>	Clicking on this button opens the editing dialog to modify the highlighted parameter in the format, most convenient for this parameter. A double click on the highlighted parameter also opens the editing dialog.
<b>Min.Value</b>	If the parameter to be modified has an allowed range in which it may be set, then clicking on the <b>Min.Value</b> button sets the minimal allowed value to the highlighted parameter.
<b>Max.Value</b>	If the parameter to be modified has an allowed range in which it may be set, then click on the <b>Max.Value</b> button to set the maximal allowed value to the highlighted parameter.
<b>Default</b>	Click on this button returns the default value to the highlighted parameter.
<b>All Default</b>	Click on this button returns the default values to all the parameters displayed in the window.

Depending of the parameter's type ChipProgUSB offers the most convenient format for the parameter editing:

Method of editing	Description
<b>Drop-down menu</b>	When the parameter value may be picked from a few preset values the dialog offers a drop-down list with these values. Highlight a new value in the list and click OK to complete the editing. For example, some microcontrollers can be programmed to work with different types of the clock generators, so the menu prompts to select one of them.
<b>Check Box dialog</b>	When some options can be set or reset the dialog appears in a form of several boxes indicating the default or lately set option statuses. To toggle the option check or uncheck the box. For example, some microcontrollers allow the locking of a particular part of the memory by setting several lock bits, so the menu

	prompts to check the lock bits represented as a set of check boxes.
<b>Customizing the parameter</b>	When the parameter value may be set freely in an allowed range the dialog offers a box for entering a new value and a history list displaying a few recently set values. The dialog prompts with the min and max values that can be set for each parameter and restricts to enter the value out of the allowed range. This type of editing is in use for setting custom values for Vcc and Vpp voltages.

#### 4.1.4.3 Buffer Dump Window

The **Buffer Dump** window displays the contents of the memory buffer.

ChipProg supports a flexible buffer structure:

- You can create an unlimited number of buffers. The number of buffers that you can open is limited only by the available computer RAM.
- Every buffer has a certain number of sub-levels depending on the type of target device. Each sub-level is associated with a specific section of a target device's address space. For example, for the Microchip PIC16F84 microcontroller every buffer has three sub-levels: 1) code memory; 2) EEPROM data memory; 3) user's identification sub-level.

This flexible structure allows for easy manipulation of several data arrays that are mapped to different buffers. To open a **Buffer Dump** window, click on the command **Main Menu > View > Buffer Dump**.

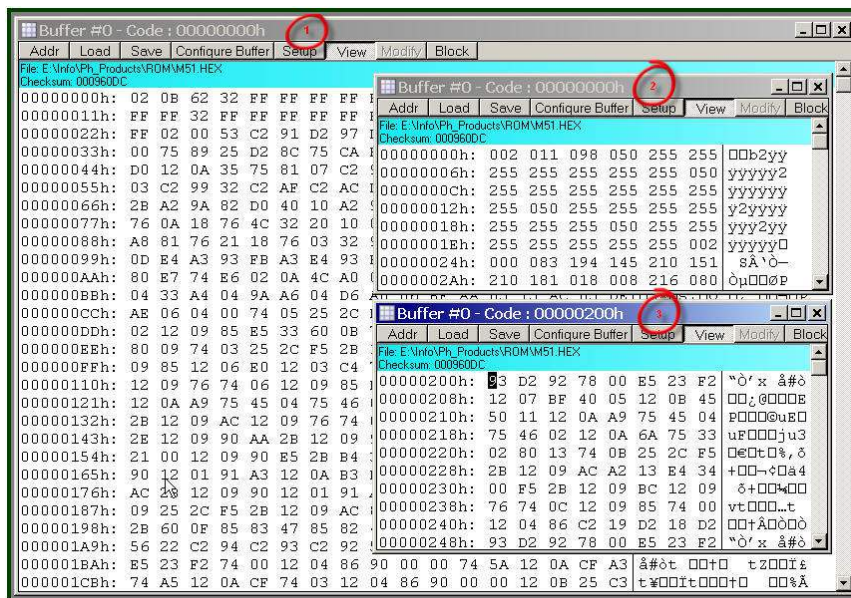

Several Windows of Same Buffer

The picture above displays three **Buffer Dump** windows representing three parts of the same buffer:

- #1 (the largest) shows the buffer contents beginning at address 0h;
- #2 shows the same buffer contents beginning at the same address but displaying data in decimal

format;

- #3 window shows the data beginning at address 200h.

The left-most column in the windows above shows absolute addresses of the first cell in a row. The addresses always increment by one byte: 0, 1, 2.... Each address is followed by a semicolon (:). When you resize the window it automatically changes the addresses shown in the address column in accordance with the number of codes or data that go in one line. Some windows may be split into two panes – left pane for data in a selected format and right pane showing the same data in ASCII format. The window has a toolbar for invoking setting dialogs and commands. Right under the toolbar the program displays a full path to a loaded file and a checksum of the dump.

#### Local menu and Toolbar

The local menu, which can be opened by the right mouse click, includes the **Buffer Dump** window context commands and dialog calls. Most, but not all, of the local menu lines are duplicated by the local toolbar buttons displayed at the top of the window. Here are the local menu and toolbar items:

Menu Command or Call	Toolbar button	Description
New address...	Addr	Opens the <a href="#">Display from address</a> dialog.
Load file to buffer...	Load	Opens the <a href="#">Load window Dump</a> dialog.
Save data to file...	Save	Opens the <a href="#">Save window Dump</a> dialog.
Configure buffer...	Configure buffer	Opens the <a href="#">Configuration Window Dump</a> dialog.
Window setup...	Setup	Opens the <a href="#">Window Dump Setup</a> dialog.
View only, edit disabled	View	By default editing in the buffer dump windows is disabled and you can only view the data. If the box is unchecked the editor will be enabled. Then you may overtype the value under the cursor.
Modify data	Modify	Opens the <a href="#">Modify data</a> dialog. This call is enabled only when the <b>View only, edit disabled</b> is off.
Operations with memory blocks	Block	Opens the <a href="#">Operations with memory blocks</a> dialog.
Swap fields	No button	This command allows swapping the cursor position between the right and left window panes.

#### 4.1.4.3.1 The 'Configuring a Buffer' dialog

The dialog allows configuring the buffer dumps in the most convenient format and name/rename open buffers. By default the first opened buffer is named 'Buffer #0'. The next buffer gets the name 'Buffer #1', and so on. You can, however, rename the buffer as you wish.

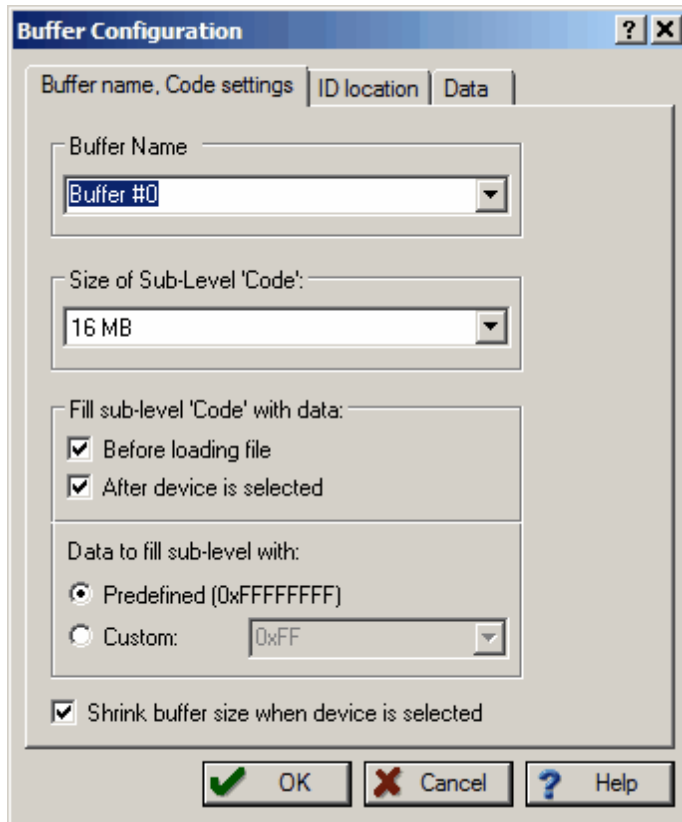

By default each buffer has a minimal size of 128K RAM in a PC and by default the ChipProgUSB program fills the buffer with a predefined value (usually 0FFh). You can customize these buffer settings - check the Custom radio button and type in the pattern to fill the buffer.

#### 4.1.4.3.2 The 'Buffer Setup' dialog

The dialog allows controlling the data presentation in the [Buffer Dump](#) window. You can open the dialog using the windows local menu (the **Windows Setup** command) or by clicking the **Setup** button on the window toolbar.

Element of dialog	Description
<b>Buffer:</b>	The field displays a list of all open buffers. The programming functions will be applied to the active one.
<b>Display Format</b>	Is represented by three radio buttons. Here you can select one of the formats for the data displayed: binary, decimal or hexadecimal.
<b>Display Data As:</b>	Is represented by four radio buttons. Here you can select the data presentation format in the buffer: 1, 2, 3 or 4 Byte.

<b>Options</b>	The options here customize the display format.
<b>ASCII pane</b>	If the box is checked the right pane will display ASCII characters corresponding to the data in the buffer dump.
<b>Display checksum</b>	If the box is checked the calculated checksum will be displayed in the blue strip over the data dump, right under the window local toolbar.
<b>Limit dump to sub-layer size</b>	If the box is checked the window dump will display a part of memory equal to the active sub-layer's size.
<b>Signed decimal and hex values</b>	If the box is checked the most significant bit (MSB) in the data shown in the binary or hexadecimal formats will be treated as a sign. If MSB=1 the data is negative, if MSB=0 they are positive.
<b>Always display '+' or '-'</b>	This is a sub-setting for the <b>Signed decimal and hex values</b> option. If both boxes are checked then the signs '+' and '-' will be displayed.
<b>Leading zeroes for decimal numbers</b>	If the box is checked then each decimal data will be shown with a number of zeros before the first significant digit - for example the value of 256 will be presented as 00000256.
<b>Reverse bytes in words (LSB first)</b>	If the box is checked then the order of bytes in words will be reversed, e.g. the MSB will follow the LSB.
<b>Reverse words in dwords</b>	If the box is checked then the order of 16-bit words in 32-bit words will be reversed.
<b>Reverse dwords in qwords</b>	If the box is checked then the order of 32-bit words in 64-bit words will be reversed.
<b>Non-printable ASCII characters</b>	The characters from the ranges <b>0x00...0x20</b> and <b>0x80...0xFF</b> are non-printable. The options here customize presentations of non-printable ASCII characters in the ASCII pane of the buffer dump window.
<b>Replace characters 0x00...0x20</b>	If the box is checked then all the characters belonging to the range <b>0x00...0x20</b> will be replaced with the character dot('.') or space(' '). The pair of toggling radio buttons <b>Replace with:</b> sets the replacement character - dot('.') or space(' ').
<b>Replace characters 0x80...0xFF</b>	If the box is checked then all the characters belonging to the range <b>0x80...0xFF</b> will be replaced with the character dot('.') or space(' '). The pair of toggling radio buttons <b>Replace with:</b> sets the replacement character - dot('.') or space(' ').

## 4.1.4.3.3 The 'Display from address' dialog

The dialog enables setting a new address that will become the first address of the visible part of the [Buffer Dump](#) window.

Element of dialog	Description
<b>Type new address to display from:</b>	Here you may enter any address within the allowed range.
<b>History</b>	Displays the list of previously set addresses. Here you can pick one for displaying the buffer dump.

## 4.1.4.3.4 The 'Modify Data' dialog

The dialog enables editing the data in the [Buffer Dump](#) window. The dialog can be invoked only when the **View** button on the window's toolbar is off, otherwise the editing is blocked. To modify particular data in the buffer appoint the location by a cursor and click the **Modify** button on the window's toolbar. Then enter a new data value in the pop-up box or pick one from the history list. Or, alternatively, appoint the location by a cursor and type over the new data on the PC keyboard.

## 4.1.4.3.5 The 'Memory Blocks' dialog

The ChipProgUSB program allows complex operations with memory blocks. This dialog controls operations with blocks of data within one selected buffer or between different buffers.

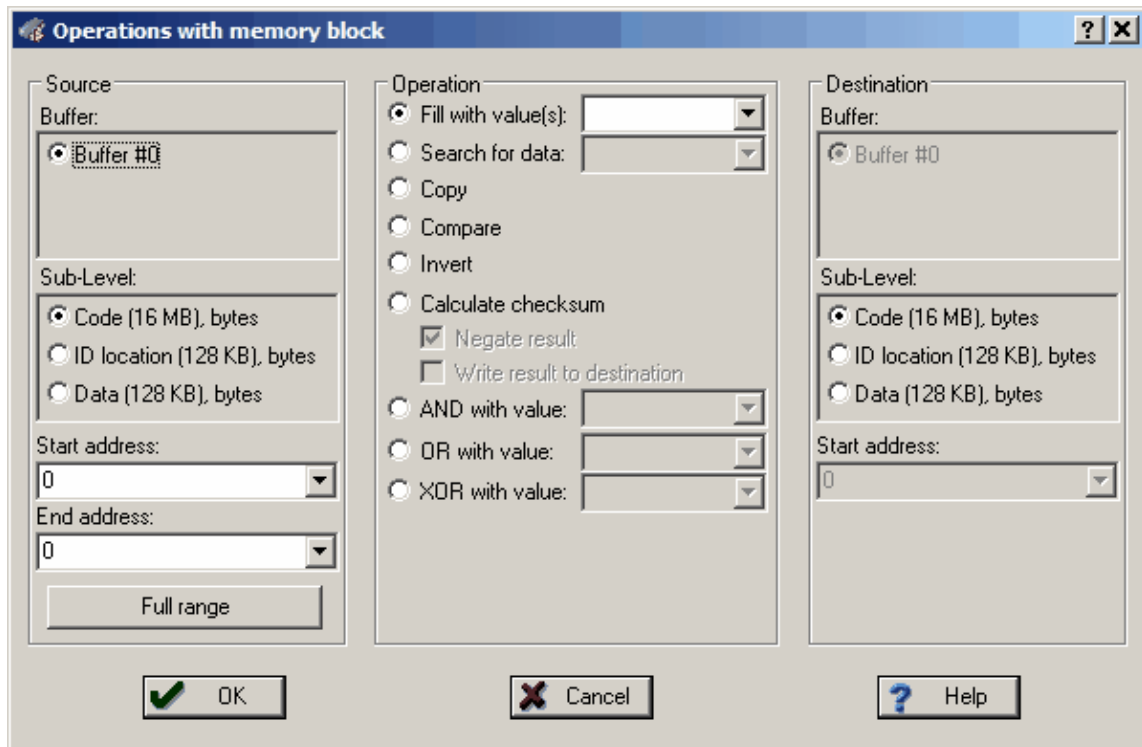

The dialog box splits in three columns. The **Source** parameters, shown in the left column, specify the source memory area for the operations shown in the middle column. The operation's result will be placed in the area specified by the **Destination** shown in the right column. By default the destination is equal to the source space. Two operations – Fill and Search - do not require a destination address so the dialog disables the **Destination** radio button if these two operations are chosen.

<b>Element of dialog</b>	<b>Description</b>
<b>Start Address</b> (of the Source)	The start address of the memory area in the selected <b>Source buffer</b> , to which the operation will be applied.
<b>End Address</b> (of the Source)	The memory area's end address. It can be set only for the <b>Source</b> . After the source address range is defined, the program automatically calculates the destination area's end address.
<b>Full Range</b> (of the Source)	Sets the start and end addresses equal to the entire address space of the selected target device.
<b>Start Address</b> (of the Destination)	The start address of the memory area in the <b>Destination buffer</b> where the result of the chosen <b>Operation</b> will be placed to.

The following operations are available through this dialog. Each operation starts when you click **OK** in the dialog box. (see notes below).

<b>Operation</b>	<b>Description</b>
<b>Fill with Value</b>	Fills the source buffer with a value (or a sequence of values) specified in the text box at the right.
<b>Search for Data</b>	Searches the source memory area for a particular value (or a sequence

	of values) specified in the text box at the right.
<b>Copy</b>	Copies a specified area of memory to a new destination address. The block can be copied within the same address space or to another one.
<b>Compare</b>	Compares contents of the specified source and destination memory areas. The sizes of the source and destination areas are equal. If there's a mismatch, the mismatch message box will require permission to continue the comparison.
<b>Invert</b>	Inverts the selected source area contents bit-wise and places the results in the destination area.
<b>Calculate Checksum</b>	Calculates the checksum, as a 32-bit value, for the source area of memory. The calculation is done by simple addition. See the note below.
<b>Negate Result</b>	If the box is checked then a checksum, calculated as a 32-bit value by simple addition, will be then subtracted from zero (this is a known method of the checksum calculation).
<b>Write Result to Destination</b>	If this box is checked a calculated 32-bit checksum will be written to the destination sub-level beginning at a specified destination <b>Start Address</b> . If this box is cleared the checksum will be displayed as a message only.
<b>AND with Value</b>	Performs bit-wise AND operation on the contents of the specified source memory locations with the operand specified in the text box on the right and places the results in the destination. See notes below.
<b>OR with Value</b>	Performs bit-wise OR operation on the contents of the specified source memory locations with the operand specified in the text box on the right and places the results in the destination.
<b>XOR with Value</b>	Performs bit-wise XOR operations on the contents of the specified source memory locations with the operand specified in the text box on the right and places the results in the destination.

#### Notes

1. The source and destination memory areas may overlap. But, since operations with memory blocks are carried out using a temporary intermediate buffer, the overlap does not corrupt the results.
2. The **Copy** and **Compare** commands use the blocks specified in the **Source** address space and the **Destination** address space.
3. The checksum is calculated as a 32-bit value by simple addition. If a memory space has byte organization, then 8-bit values will be added. If it has word organization then 16-bit values will be added.
4. Logical operations (AND, OR, XOR) are performed with the contents of the **Source** address space, while the operation result will be written to the **Destination** address space. The program takes care of converting the operands to the appropriate memory size for a selected type of memory (16-bit for the **Prog**, **Data16**, **Reg** and **Stack** memory, 8-bit for the **Data8** memory).

#### 4.1.4.3.6 The 'Load File' dialog

The dialog defines parameters of the file to be loaded to the buffer.



Element of dialog	Description
<b>File Name:</b>	Enter a full path to the file in this box, pick the file name from a drop-down menu list or browse for the file on your computer or network.
<b>File Format:</b>	The <b>format</b> of the file to be loaded can be selected here by checking one of the radio buttons in the <b>File Format</b> field of the dialog.
<b>Buffer to load file to:</b>	Select the buffer in which the file will be loaded by checking one of the <b>Buffer#</b> radio buttons. There may be just one such button.
<b>Layer to load file to:</b>	The <b>Buffer to load file to</b> can have more than one memory layer. Select the layer in which the file will be loaded by checking one of the radio buttons. There may be just a single button available for choosing.
<b>Start address for binary image:</b>	Files in <b>Binary</b> file format do not carry any address information and are required to define the start address for the loading. If the file to be loaded is a binary image enter the start address in the box here.
<b>Offset for loading address:</b>	Files in any formats, except the <b>Binary</b> file format, can carry the information about the start address for the loading. If the file to be loaded is not a binary image enter the offset for the file addresses in the box here. The offset can be positive or negative.

#### 4.1.4.3.6.1 File Formats

The ChipProgUSB program supports a variety of file formats that can be loaded to the ChipProg buffers.

File format	Description
<b>Standard/Extended Intel HEX (*.hex)</b>	The Intel HEX file is a text file, each string of which includes the beginning address to load the data to the buffer, the data to load, checksums for the string and some additional information. The ChipProgUSB loader supports both Standard and Extended Intel HEX format.
<b>Binary image (*.bin)</b>	The binary image includes the data to be loaded only. These data will be loaded to the buffer beginning from a specified start address.
<b>Motorola S-record (*.hex, *.s, *.mot)</b>	The Motorola S-record is a text file, each string of which includes the beginning address to load the data to the buffer, the data to load, checksums for the string and some additional information. The ChipProgUSB loader supports all kinds of the Motorola S-records

with the extensions .hex, .s, .mot.

<b>Altera POF (*.pof)</b>	The Altera POF-file is a text file, each string of which includes the beginning address to load the data to the buffer, the data to load, checksums for the string and some additional information. The format is mostly used for programming PALs and PLDs.
<b>JEDEC (*.jed)</b>	This format is used for programming PALs and PLDs. The JEDEC-file includes the beginning address to load the data to the buffer, the data to load, test-vectors and some additional information.
<b>Xilinx PRG (*.prg)</b>	The Xilinx PRG-file is a text file, each string of which includes the beginning address to load the data to the buffer, the data to load, checksums for the string and some additional information. The format is used for programming the Xilinx PLDs.
<b>Holtek OTR (*.otp)</b>	This format is presented by Holtek company. The OTP-file includes the beginning address to load the data to the buffer, the data to load, checksums for the string and some additional information.
<b>Angstrom SAV (*.sav)</b>	This format is presented by Angstrom company (Russia). The SAV-file includes the beginning address to load the data to the buffer, the data to load, checksums for the string and some additional information.
<b>ASCII Hex (*.txt)</b>	The ASCII TXT-file includes the beginning address to load the data to the buffer, the data to load, checksums for the string and some additional information.

#### 4.1.4.3.7 The 'Save File' dialog

The dialog defines parameters of the file to be saved from the buffer.

Element of dialog	Description
<b>File Name:</b>	Enter a full path to the file in this box, pick the file name from a drop-down menu list or browse for the file on your computer or network.
<b>Addresses</b>	<b>Start and End Addresses</b> define the buffer data space that will be saved in the <b>File</b> . For saving an entire buffer click the <b>All</b> button.
<b>File Format:</b>	The <b>format</b> of the file to be saved can be selected here by checking one of the radio buttons in the <b>File Format</b> field of the dialog.
<b>Buffer to save file from:</b>	Select the source buffer from which the file will be saved by checking one of the <b>Buffer#</b> radio buttons. There may be just a single button available for choosing.
<b>Sub-level to save file from:</b>	The <b>Buffer to save file from</b> can have more than one memory layer. Select the source layer by checking one of the radio buttons. There may be just a single button available for choosing.

#### 4.1.4.4 The Device Information window

This window displays the type of selected target device and a list of programming adapters that fit all available packages for the selected device. For example the picture below shows all Phyton adapters available for the selected PIC microcontroller. The Socket scheme pictograms below show the correct positions of a DIP-packaged 40-pin PIC chip and the adapter board into a 48-pin ZIF socket (for the ChipProg -48 programmer).

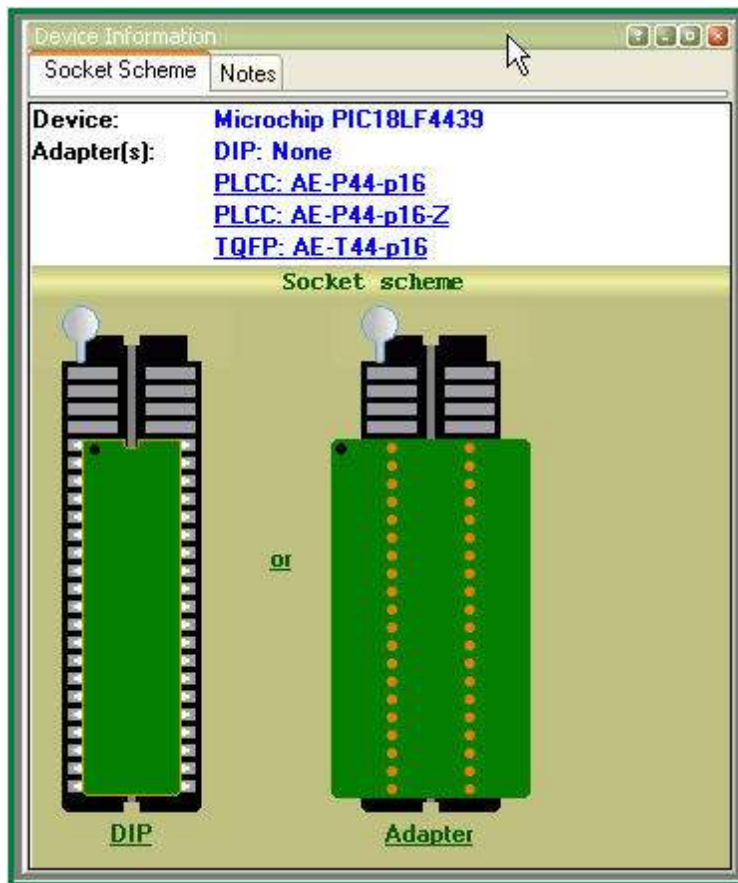

The adapter part numbers are linkable and the links being clicked opens the [adapters.chm](#) file with a description and wiring diagram of the chosen adapter. The cable adapters for in-system programming are also included into the [adapters.chm](#) file. There are some peculiarities that such ISP adapters use depending on the target device type.

##### 4.1.4.4.1 Phyton programming adapters

The adapters.chm file includes short descriptions of the Phyton programming adapters and their wiring diagrams. Having the adapter diagram a ChipProg user can master it is own adapter or to find the adaptor available from a third party, which can be used as a replacement for the Phyton brand adapter.

The adapters diagram are presented in a table form, where the rows show connections of the elements installed on the adapter transition board and the columns (from the left to right) represent:

- 1st column - Pin numbers of the dual-row pins pluggable to the programmer ZIF socket
- 2nd column - Pin numbers of the ZIF socket installed on the adapter top
- 3rd, 4th, 5th, etc. - Pin numbers of the passive and active components installed on the adapter board.

See an example of the AE-P44-A32/64 adapter connection table below:

Pin# of the dual-row 40-pin plug (ChipProg ZIF socket)	Pin# of the PLCC 40-pin adapter socket	74HC14 latch	C1 (.1uF)	C2 (.1uF)
1	2			
2	4			
3	6			
4	28			
5	29			
6	9			
7	10			
8	11			
9	12			
10	40			
11	7			
12	13			
13	14			
14	16			
15	17			
16	18			
17	19			
18	20			
19	21			
20	22,30,42	7	1	1
21	24			
22	25			
23	26			
24	27			
25	8			
26	31			

27	32			
28	33			
29	34			
30	5			
31	36			
32	35,3,15,23	14	2	
33	37			
34	38			
35	39			
36	40			
37	41			
38		11		
-	43	12		
39	44			2
40	1			
		10,13		

#### 4.1.4.4.2 Adapters for in-system programming

The adapters.chm file includes short descriptions of the Phytion programming adapters for in-system programming (e.g. the programming in the user's equipment) and their wiring diagrams the schematic of connecting the adapter cables to the target. The cable adapters may have 10 to 20 pin headers to be connected to the pins or complimentary connectors installed in the user's equipment. The pin connection is specific for certain target devices. The connection diagrams are presented in a table form, where the columns (from the left to right) represent:

- 1st column - Pin numbers of the cable adapter header inputs and outputs
- 2nd column - Signals of the target device to be connected

As an example see below a schematic of connecting a 10-pin header BH-10 of the Phytion AE-ISP-U1 cable adapter to the Zilog Z8Fxxx microcontroller for in-system programming.

BH10	Z8Fxxxx
1	<b>Vcc</b>
2	<b>RESET</b>
3	<b>GND</b>
4	<b>DBG</b>
5	<b>GND</b>
6	
7	
8	

9	
10	

As you can see here not all the BH10 lines should be necessarily used. Only five signals are required for programming this device and only two of them are used for sending the the programming signals into the chip - RESET and DBG. The diagrams in the adapters.chm file use the mnemonic of signal from the device manufacturers' data sheets.

#### 4.1.4.5 The Console Window

The Console window displays messages generated by the ChipProgUSB program that can be divided into two groups: the ChipProg error messages and what-to-do prompts. The window stores messages even if it is closed. You can open it at any time to view the last 256 messages, and get help for any of them. The error messages are shown in red color, others in black.

The window should be large enough to watch several messages. To save screen space you can close the **Console** redirecting all messages to the popping-up message boxes. To do this, go to the **Configure menu > Environment > Misc** tab and select the **Always Display Message Box** option. Alternatively you can select the **Do not open box if Console window opened** option, redirecting all the messages to the **Console** window.

Click the **Help** button in the box or to invoke the ChipProg context-sensitive **Help** topic associated with the error, or click the **Close** button and continue after correcting a parameter error.

#### Local menu and Toolbar

The local menu, which can be opened by the right mouse click, includes the **Console** window context commands and dialog calls. Most, but not all, of the local menu lines are duplicated by the local toolbar buttons displayed at the top of the window. Here are the local menu and toolbar items:

Menu Command or Call	Toolbar button	Description
<b>Clear Window</b>	<b>Clear</b>	Deletes all the messages from the window
<b>Help on message</b>	<b>MHelp</b>	Opens the context-sensitive <b>Help</b> topic associated with the error or information in the highlighted message
<b>Help on window</b>	No button	Opens the <b>Console</b> window <b>Help</b> topic
<b>Help on word under cursor</b>	No button	Opens the context-sensitive <b>Help</b> topic associated with the word appointed by the cursor

#### 4.1.4.6 Windows for Scripts

ChipProgUSB is featured with the windows specifically supporting operations with scripts. That includes:

- [\(Script\) Editor](#) windows
- [Watches](#) windows
- [User](#) windows
- [I/O Stream](#) windows

These windows cannot be open from the [View menu](#); they can be opened only when you work with scripts. Operations with these windows are described in the chapter [Scripts Files](#).

#### 4.1.5 Simplified User Interface

The ChipProg default graphic user interface makes heavy use of menus, windows and controls that are redundant for mass production. Furthermore, an unskilled operator is usually employed for this work. Programming a lot of chips of the same type with the same data is routine work that includes two operations: replacing a target device in a socket and executing a preset batch of programming operations ([Auto Programming](#) command). To prevent casual ChipProg mismanagement and to simplify routine operations the ChipProgUSB enables switching the ChipProg [graphical user interface](#) from the default mode to the **Simplified User Interface** mode (hereafter **SUI**). In this mode an operator watches a very limited PC screen with only relevant information (see two SUI screen examples below).

Single site device programming mode

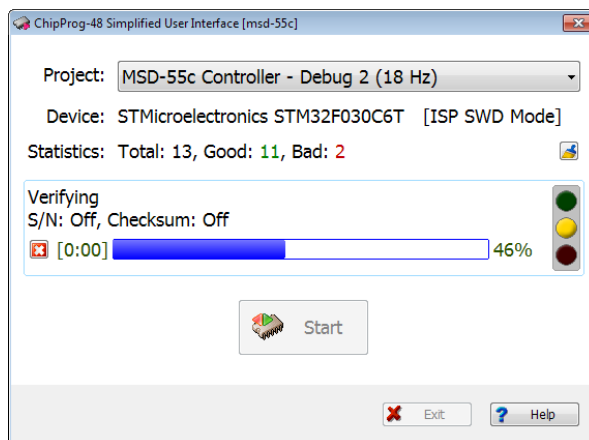

Gang device programming mode

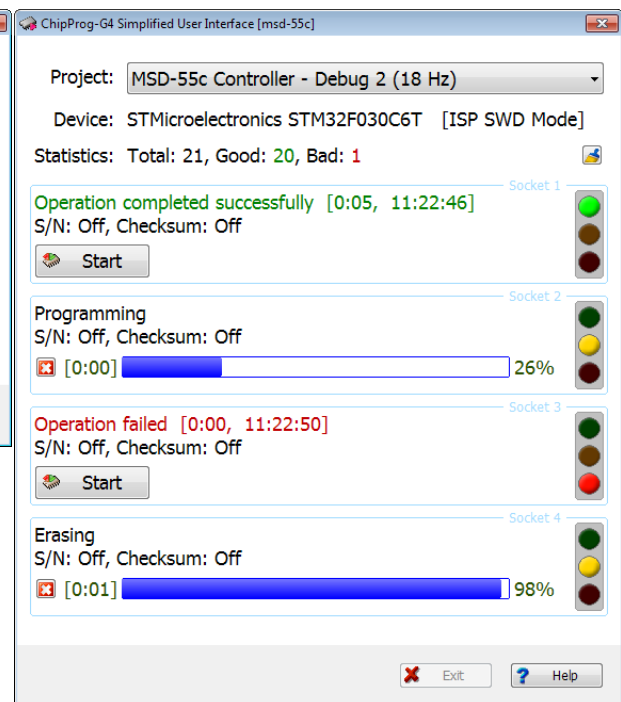

The SUI mode is allowed only for use of ChipProg with one type of executing command: [Auto Programming](#).

A typical scenario of use includes two steps:

1. **Setting**. An engineer or a technician (hereafter a supervisor) sets the programming session using the default ChipProg [graphical user interface](#) and stores the session [project](#); then the supervisor switches the user interface to the SUI mode and transfers control of the ChipProg to an unqualified operator;
2. **Use**. The operator then replaces the chips and presses the **Start** button (unless the programmer is set to detect the device [insertion automatically](#); in this case he/she just replaces the chips).

The project file can be stored on a PC hard drive with no restrictions for the project file location.

The session project includes the device type, file name, [serialization](#) parameters, check sum, list of the functions included in the [Auto Programming](#) batch and other options, including the SUI [windows and controls configurations](#), and the [AutoDetect](#) setting. The SUI interface [settings](#) include a list of pre-configured projects, so an operator can launch a project from the list.

For [launching](#) the ChipProg with the SUI a supervisor can create an icon on the PC's desktop and specify the project and configuration files.

**Note!** The ChipProgUSB does not protect the SUI project files and window configurations against unauthorized modifications by an operator or any third party.

[Settings of Simplified User Interface](#)

[Operations with Simplified User Interface](#)

#### 4.1.5.1 Settings of Simplified User Interface

First, make the following preparations for making a project that will control the programming session with the SUI. Start from the following steps:

- Menu [Configuration](#) - select the target device;
- Menu [Configuration](#) - set up the [buffer](#);
- Menu [Configuration](#) - set up options for the device [serialization](#), writing [check sum](#) and [signatures](#), and [log file](#) controls;
- Windows [Device and Algorithm Parameters Editor](#) - specify the options different from default for a chosen device.
- Windows [Program Manager](#) > tab [Program Manager](#) > the [Edit Auto](#) dialog - configure the [Auto Programming](#) batch of functions;
- Windows [Program Manager](#) > tab [Options](#) - set the programming options;
- Windows [Program Manager](#) > tab [Statistics](#) - set a number of chips to be programmed and other options

Working in the SUI mode disables counting down the programmed chips (this option can be set in the tab [Statistics](#)), an operator can watch only numbers of successfully programmed and failed chips. Other options set in this tab remain in force.

Second, create the project. Select the menu **Project > New**. In the [Project Options](#) dialog specify the project name, file name and format and other options; then click the **OK** button to store the project. It is absolutely crucial to store the project. Then follow to setting the SUI options.

Under the [Configuration](#) menu click the command **Simplified mode editor**. This will open the **Simplified Mode Setup** window with the **SUI** window docked to the first window at left (see below). Any changes made in the **Simplified Mode Setup** window immediately become visible in the **SUI** window. Clicking the **OK** button in the **Simplified Mode Setup** window completes the SUI setup, the window closes and the button **Return to editing** appears in the **SUI** window. This allows quick switching back and forth from SUI session editing to programming chips.



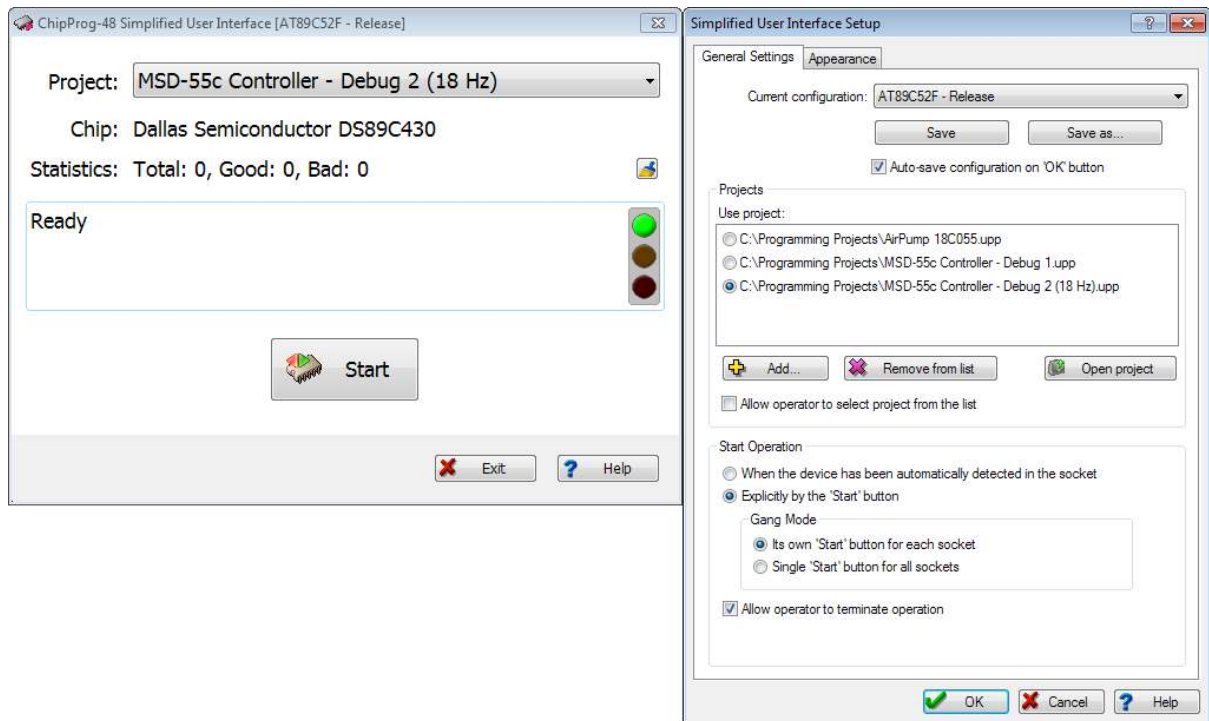

### The General Settings Tab

The **Current configuration** field displays the name of the currently chosen SUI configuration. The configuration files with the extension **.smc** are located in the folder **SMConfig**; this folder is located in the working ChipProgUSB folder. The **Save** button allows saving the configuration under the name entered in the field **Current configuration**; the **Save as...** button allows saving it under another name. If the **Auto-save configuration on 'OK' button** box is checked then clicking the **OK** button at the bottom of this tab will automatically save the current configuration and close the dialog.

The **Projects** pane lists all the projects associated with the current configuration. When you open the **Simplified Mode Setup** window for the first time, the **Projects** list is blank. To add a project use the **+** **Add** button. One configuration may include more than one project if it is necessary to enable an operator to change projects without restarting the programmer. If **Allow operator to select project from the list** box is checked, then the **SUI** window displays all the projects associated with the current configuration; otherwise, it displays only one project selected from the **Use project** list. To remove a project from the **Use project** list, highlight it and click the **x Remove from list** button. This will remove the project from the list but not from the disc. The **Open project** button loads a selected project and does not close the editor.

The **Start Programming** pane gathers appropriate settings. By checking the **When the device has been automatically detected in the socket** radio button you allow immediate launching of the programming operation upon detecting the chip in the ChipProg socket. If this option is checked, the **Start** button (or buttons in the gang mode) in the **SUI** window will be replaced with the [auto detect](#) acknowledgment indicator.

Alternatively, the programming operation can be initiated by operator manipulation. Check the **Explicitly by the 'Start' button** radio button and, if you use the [gang programming](#) mode, check one of two radio buttons: **Its own 'Start' button for each socket** or **Single 'Start' button for all sockets**. Checking the **Its own Start button for each socket** option radio button allows an operator to replace a chip in a

socket and immediately press the **'Start'** button so the chips are programmed asynchronously. Checking the **Single 'Start' button for all sockets** option radio button allows an operator to insert as many chips as desired in programming sockets at once (for example, 4 chips when using the ChipProg-G41 gang programmer) and then to press any **'Start'** button to initiate concurrent chip programming on all programming sites. In this mode, replacing the target chips is possible only upon completing the programming procedures on all sites.

The only **Auto Programming** command batch can be initiated by pressing the Start button. This command can be executed either by pressing the mechanical button on the ChipProg unit or by clicking the **'Start'** virtual button in the **SUI** window.

If the box **Allow programming termination by operator** is checked, an operator is able to stop the programming by clicking the **Exit** button in the **SUI** window, otherwise the operator can only initiate device programming.

### The Appearance Tab

Here you can individually choose the type, size and color of the **Default Font** for each element that can be displayed in the **SUI** window: **Project name**, **Device part number**, **Statistics**, **Device operation status**, and **"Start" button**. **Move up** and **Move down** allow customization of the element position in the **SUI** window. By checking appropriate boxes under the **Display elements** titles you can enable displaying them in the **SUI** window.

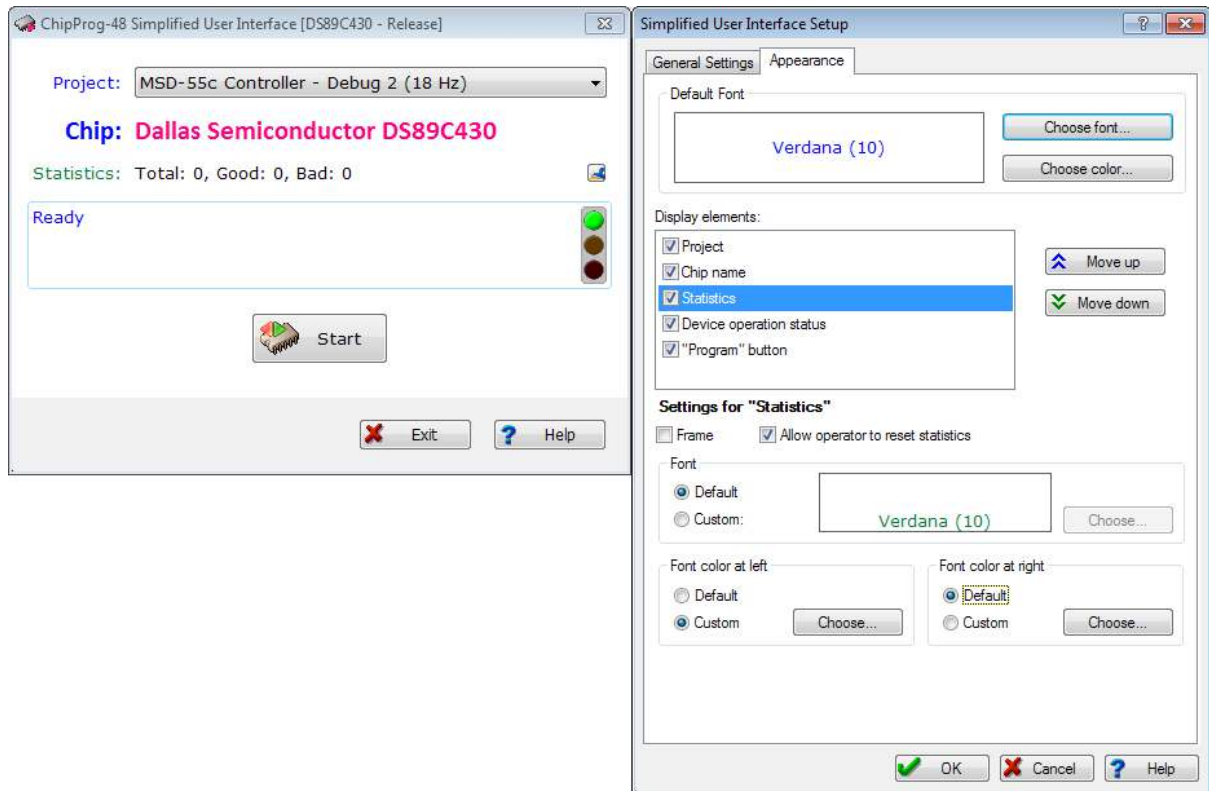

Then, by highlighting an element enabled for display in the **SUI** window, you can individually set an appearance of each element if you wish its appearance to differ from the default and from other elements. Checking the **Frame** box causes a thin blue frame to appear around the element's field. Radio

buttons **Font**, **Font color at left** and **Font color at right** enable the creation of appearances that distinguish the elements displayed in the **SUI** windows.

When the **Statistics** element is highlighted, the box **Allow operator to reset statistics** appears. Checking this box enables an operator to clear the current programming statistics.

When the **Device operation status** element is highlighted, two extra boxes: **Serial number** and **Checksum** appear. Checking these boxes enables the [serial number](#) and the [check sum](#) written into the last programmed device to be displayed below the status line.

#### 4.1.5.2 Operations with Simplified User Interface

To launch the ChipProgUSB with the [Simplified User Interface](#) (or in the **Simplified Mode**) in the [Command line](#) mode use the key `/Y <configuration name>`. The key `/Y` and the `<configuration name>` should not be separated by a space. If the `<configuration name>` includes spaces the name should be quoted. For example:

```
C:\Program Files\ChipProgUSB\5_22_00\UprogNT2.exe /Y"DS89C430 - Release" ,
```

where the **DS89C430 - Release** is the configuration name.

When launched in the Simplified Mode the ChipProgUSB displays only the SUI window. The main ChipProgUSB window remains invisible until an error occurs. When a programming operation fails, the programmer behaves in accordance with the settings that control errors. These settings are available through the menu [Configure](#) > [Preferences](#). If the box **Terminate device operation on error and do not display error message...** in the **Preference** dialog is unchecked (default setting) the ChipProgUSB will issue an error message and prompt to either ignore the error and resume operation or to terminate it. If this box is checked, any error will cause the programming session to come to a complete stop. The error message will not be issued.

## 4.2 Operations with Projects

Usually, operating with a device programmer includes a lot of preparations, such as: choosing a target device, loading a file to be programmed into the device, customizing the programming algorithm, pre-programming a batch of commands for the [Auto Programming](#) procedure, configuring the ChipProg user interface, etc. These preparations involve opening tens of dialogs spread in several ChipProgUSB windows, menus and sub-menus. The ChipProgUSB program enables storing all the settings in one file known as a **project**. You can [create and set up](#) an unlimited number of projects for programming of different devices, with different files and different parameters, and store them in the [project repository](#) from where you can load them for execution by clicking your mouse, or by including the project name in the [command line](#). Operating with projects saves time and simplifies the programming job.

Use of projects is especially beneficial for **production** programming when a typical scenario includes replication of a lot of chips programmed with the same data but different serial numbers. In this case it is very convenient to create and lock a project that completely defines the programming session and then allow a programming operation to a worker who will simply replace the chips being programmed and watch the programming progress and results.

The matrix below lists major project options.

Option group	Project options	Where to set up...
Major properties	Project name; Description; Permissions	Menu <b>Project</b> - Options - Dialog <a href="#">Project Options</a>

Option group	Project options	Where to set up...
	(password, selected locking options); Files to be programmed into the device, File format, Start and end address for file loading, Destination buffers; Scripts to be preloaded; Desktop.	
<b>Device</b>	Device type; Auto Detect; Insert test; Check device ID; What to do when the device insertion is detected; Device parameters (fuses, lock bits, special function registers, etc.); Programming algorithm (applicable chip sectors, voltages, oscillator frequency, etc.)	Menu <a href="#">Configure</a> - Dialog <a href="#">Select Device</a> ; Check box <a href="#">AutoDetect</a> ; Window <b>Program Manager</b> - tab <a href="#">Options</a> Windows <a href="#">Device and Algorithm Parameters Editor</a>
<b>Buffers</b>	Buffer name; Buffer size; Default fill value; Swap file settings.	Menu <a href="#">Configure</a> – sub menu <a href="#">Buffers</a> ; Window <b>Buffer</b> – toolbar; Dialog <a href="#">Buffer Configuration</a> ; Window <b>Buffer</b> – toolbar; Dialog <a href="#">Memory Dump Windows Setup</a>
<b>Serialization, Check sum, Log files</b>	Algorithm for programming serial numbers; Custom signature patterns; Algorithm of the check sum calculation; Check sum formats; Parameters and locations of log files to be saved.	Menu <a href="#">Configure</a> – tabs of the sub menu <a href="#">Serialization, Check sum, Log files</a>
<b>Actions on events</b>	Actions on certain events, issuing error messages and sounds, logging results.	Menu <a href="#">Configure</a> – sub menu <a href="#">Preferences</a>
<b>Graphical User Interface</b>	Screen configuration, fonts and colors in windows, key mappings, messages and miscellaneous settings.	Menu <a href="#">Configure</a> – sub menu <a href="#">Environment</a>
<b>Statistics</b>	Number of chips to be programmed and associated settings.	Window <b>Program Manager</b> - tab <a href="#">Statistics</a>

You can create, edit and save projects within the ChipProg **Graphical User Interface** - read about the [Project Menu](#) and associated dialogs. The project files have the extension **.upp**.

**Note!** The ChipProgUSB software does not automatically save changes of the project options upon quitting the program. You must execute the **Save** or **Save as** command from the [Project](#) menu to preserve project changed made in all user interface setting dialogs since opening this project.

## 4.3 Command Line Control

The ChipProg programmers can be driven in the **Command Line** mode. A command line begins with the registered application name **UPROGNT2.EXE** followed with a number of options that specify certain ChipProg functions and settings. Sometimes these options may be also called keys. The command line may also optionally include a name of the [project](#) file that controls the programmer operations.

Here is the command line format: **UProgNT2.exe [option 1] [option 2]...[Name of the project file] [option**

**3] [option 4]...** , where the command line elements in square brackets (options and project name) are optional and may follow in any order separated by spaces. The square brackets characters are not parts of the option or project name.

Each option begins with one of two characters: either '/' (slash) or '-' (hyphen) followed by the reserved names listed in the [Command line options](#) table. The '/' (slash) and '-' (hyphen) characters in command line options are absolutely equivalent. *For example: '/L', is the same as '-L'.*

Characters in the command line options, project names and the application executable name are case-insensitive, so there is no difference between the '/A' and '/a' options. If the file name includes spaces the file name should be quoted. *For example: -L "Data file 5.hex".*

Some options in the [Command line options](#) table require additional parameters; these are shown in this table in angle brackets (< >). These parameters specify file names, devices, text strings, serial numbers, etc. that should follow options without a space. *For example: "/LData file 5.HEX" (load the Data file 5.HEX to the buffer right after launching the programmer) or "/FH" (the file format is hexadecimal).*

Upon executing a command line the ChipProgUSB checks whether a project loaded before the program has been closed at the previous programming session. If it has, the program automatically reloads this old project unless a new project name is specified in the command line.

There is no difference between loading a project by executing a command line, or loading it manually by means of the ChipProgUSB user interface menus.

Here are a few command lines examples:

**1) UProgNT2.exe -C"Atmel^AT89C51ED2 [ISP BL Mode]" -L"C:\Work\Output Files\Bin\Serial.bin" -FB0x2000 -A -I2**

Right after launching the ChipProgUSB application:

-C"Atmel^AT89C51ED2 [ISP BL Mode]" - select the Atmel AT89C51ED2 [ISP BL Mode] device;  
-L"C:\Work\Output Files\Bin\Serial.bin" - then load the file C:\Work\Output Files\Bin\Serial.bin into the buffer #0;  
-FB0x2000 - specify the binary format for the Serial.bin file with the start address 0x2000 in the buffer;  
-A - then begin the Auto Programming session using the default set of commands programmed in the Auto Programming menu;  
-I2 - make the ChipProgUSB main window invisible, when the Auto Programming session completes. if an error occurs, copy the error message to the clipboard and close the ChipProgUSB application.

**2) UProgNT2.exe "C:\Work\Programmer Projects\Nexus.upp" /A1**

Right after launching the ChipProgUSB application load the project file 'Nexus.upp' from the folder C:\Work\Programmer Projects\ and launch the Auto Programming session from buffer #1. If the programming was successful, close the ChipProgUSB application. The ChipProg main window remains visible.

**3) UProgNT2.exe**

Launch the ChipProgUSB with no options.

### 4.3.1 Command line options

An option name begins with one of two characters: either '/' (slash) or '-' (hyphen), followed by the reserved names listed below. The '/' (slash) and '-' (hyphen) have the same effect; there is no difference whatever. *For example, '/F', '-L'.*

Options	Description
<b>-GANG[:&lt;number of sockets&gt;]</b>	This option launches the ChipProgUSB in the <a href="#">multi-programming</a> (gang) mode. In this mode the ChipProgUSB software drive multiple programmers, i.e. either a ChipProg-G4 or ChipProg-G41 gang programmer or multiple single-site ChipProg programmers connected to one computer. You must use this key to control the ChipProg-G4 or ChipProg-G41 gang programmers. The <b>-N</b> , <b>-P</b> and <b>-R</b> keys below may not be included in the same command line with the <b>-GANG</b> key.
	The <b>/GANG</b> key can be supplemented by a parameter <b>[:&lt;number of sockets&gt;]</b> that specifies a number of programming modules in the controlled gang machine or a programming cluster. For example, the <b>/GANG[:&lt;2&gt;]</b> key says that USB communication will be established only with two first programming modules in the gang machine. This allows to expedite establishing USB communication with the gang programmer. If the ChipProgUSB has been launched with the <b>-GANG</b> key the program waits up to 16 sec or until all multiple of 4 device programmers were detected, whichever happens earlier. For example, the <b>-GANG[:&lt;2&gt;]</b> key stops establishing USB communication when first two programming modules were detected.
<b>-C"&lt;manufacturer ^device&gt;"</b>	This option opens the ChipProgUSB program with a device specified as a combination of the device manufacturer and device part number separated by the ^ character. The device specified in a previously loaded project will be replaced by a device specified by the <b>-C"&lt;manufacturer ^device&gt;"</b> key. <i>For example: /C"Atmel^AT89C51".</i>
<b>-L&lt;file name&gt;</b>	This option loads the <b>&lt;file name&gt;</b> file into the ChipProg buffer immediately after launching the ChipProgUSB program. If other files were previously loaded with some project then a new one will be loaded in accordance with the file format and start address. The loader automatically recognizes the <a href="#">file format</a> in accordance with the file extension. If an actual file format differs from one listed in the <a href="#">file format</a> list, use the option <b>-F</b> ; this option enables you to explicitly specify the file format (see below).
<b>-F&lt;file format&gt;</b>	This key explicitly sets the format of the file specified by the option <b>-L&lt;file name&gt;</b> above. The <b>&lt;file format&gt;</b> is specified by one of the following letters:  <b>H</b> - standard or extended Intel HEX format <b>B</b> - binary format <b>M</b> - Motorola S record format <b>P</b> - POF (Portable Object Format) <b>J</b> - JEDEC format <b>G</b> - PRG format <b>O</b> - Holtek OTP format

	<p><b>V</b> - Angsrem SAV format</p> <p><i>For example: the option -FH loads a file in the HEX format, which defines the start destination address in the ChipProg buffer.</i></p> <p>If the binary format (<b>B</b>) is specified by the option <b>-F</b> then it may be accomplished by a hexadecimal value that specifies the destination start address of the file to be loaded. <i>For example: the option /FBFF04 loads a binary file and places the data at the address FF04h in the buffer.</i></p> <p>If a command line includes a key <b>-F&lt;file format&gt;</b> but does not include a key <b>-L&lt;file name&gt;</b>; i.e., it specifies the file format but does not specify the file name itself, the <b>-F&lt;file format&gt;</b> option will be ignored.</p>
	<p><b>Note</b> that use of the <b>-C</b>, <b>-L</b>, <b>-F</b> command line keys is less beneficial than use of <a href="#">projects</a>, which allows much more flexible and effective control of device programming. It is highly recommended, and especially for mass production, to open, configure and store as many projects as you need and launch them from a command line.</p>
<b>-A[buffer number]</b>	<p>This option initiates the <a href="#">Auto Programming</a> session in accordance with other command line options immediately after launching the ChipProgUSB application. It closes this application in case of successful completion. In case of error the ChipProgUSB application remains suspended until it is closed manually. If the <b>[buffer number]</b> is omitted then the data for Auto Programming are taken from buffer #0; otherwise from the buffer number that follows the <b>-A</b>. <i>For example: the option -A2 specifies that data for the Auto Programming session will be taken from the buffer number 2.</i></p> <p>It makes sense to use the <b>-A</b> option only when including in the command line a project name or the <b>-L&lt;file name&gt;</b> option.</p>
<b>-I</b>	<p>This key makes the ChipProgUSB application main window invisible until a programming error occurs. In case of error the window appears on the PC screen along with the error message. Use of this option makes sense only if the option <b>-A</b> (Auto Programming) is included in the same command line. Otherwise the <b>-I</b> option will be ignored.</p>
<b>-I1</b>	<p>This key is similar to the <b>-I</b> key but use of the <b>-I1</b> holds the ChipProgUSB application main window invisible even if a programming error occurs. The first occurrence of a programming error returns the error code 1 and closes the ChipProgUSB program. (A successful Auto Programming session ends with returning the code 0). These return codes can be conveniently used by an external application that controls the ChipProg remotely; for example, LabVIEW, similar programs or batch files.</p>
<b>-I2</b>	<p>This key is similar to the <b>-I</b> key, but use of <b>-I2</b> holds the ChipProgUSB application main window invisible, suppresses displaying error messages, but copies them to the Windows clipboard.</p>

<b>-M</b>	Including this key in the command line launches the ChipProgUSB software in the demo mode, which does not require use of the ChipProg hardware and real data exchange between a computer and the programmer hardware. Use of this mode is convenient for product evaluation without the ChipProg hardware.
	<p><b>Important!</b> The three keys below - <b>-N&lt;serial number&gt;</b>, - <b>P&lt;identifier&gt;</b> and <b>-R</b> - allow control of one single-site programming module, either from a cluster of similar multiple programmers or inside a gang device programmer, but only when the programmers are not driven in the <a href="#">gang mode</a>. These three keys may not be used with a combination of the key <b>-GANG</b>.</p> <p>Use of these keys may be convenient when, for example, it is necessary to program two different files into two different device types on two pairs of programming sites of the Phyton gang machine. In this case each pair of programming modules specified by the <b>-R</b> or <b>-P</b> keys can perform two different programming jobs simultaneously.</p>
<b>-N&lt;serial number&gt;</b>	This key enables operations with a particular single-site ChipProg programmer from a cluster of multiple programmers driven from one PC but only when these programmers <b>are not</b> controlled in the gang mode (with the key <b>-GANG</b> ). Each single programmer has its own unique serial number ( <b>&lt;serial number&gt;</b> ) enabling you to address it by this serial number. A serial number can be found on the bottom of the programmer case or, better, by opening the menu <a href="#">Help &gt; About...</a> . Serial numbers of all single programmers connected to one PC are also available in the "Choose programmer" dialog that the ChipProgUSB program opens if the command line does not include the options <b>-N</b> or <b>-P</b> . <i>For example, the option <b>-NPHP10012A</b> specifies that all other command line options are applicable to the programmer with a serial number PHP10012A only.</i>
<b>-P&lt;identifier&gt;</b>	This key is similar to the <b>-N</b> above but it defines a single module in the gang machine or in a programming cluster by setting the site number following a reserved text identifier "Phyton Gang Programmer" for the programmers driven by the ChipProgUSB software and "Phyton Fast Gang Programmer" for the programmers driven by ChipProgUSB-01. <i>For example, the option <b>-P"Phyton Gang Programmer #2"</b> defines that all other command line options are applicable exclusively to the programming module #2.</i>
<b>-R</b>	This key is applicable <b>only</b> for operations with Phyton gang programmers (ChipProg-G41 and ChipProg-G4) but <b>only</b> when it is necessary to operate with a <b>particular programming module</b> inside of these gang machines; i.e., <b>not</b> in the <a href="#">gang mode</a> . Since all single programming modules belonging to each ChipProg gang programmer have the same serial number it is impossible to address the programming site by a serial number (key <b>-N</b> ). When one of the mentioned gang programmers is launched from the



	command line, including the <b>-R</b> option, this opens the dialog prompting a user to specify a particular number of the programming module inside of the gang machine. It is possible to use the key <b>-P</b> for choosing a programming module with a specified socket number.
<b>-S&lt;file&gt;</b>	This key replaces a default <a href="#">session configuration file</a> <b>UPROG.ses</b> by a new one with the name <b>&lt;file&gt;</b> and the extension <b>.ses</b> . The session configuration file stores major ChipProg settings, and includes a name of the last working project; it resides in the ChipProgUSB folder. The new session settings will be used by the ChipProgUSB right after the command line execution.
<b>-O&lt;file&gt;</b>	This key replaces a default <a href="#">option configuration file</a> <b>UPROG.opt</b> by a new one with the name <b>&lt;file&gt;</b> and the extension <b>.opt</b> . The option configuration file stores the target device type, file options, etc.; it resides in the ChipProgUSB folder. The new options will be used by the ChipProgUSB right after the command line execution.
<b>-D&lt;file&gt;</b>	This key replaces a default <a href="#">desktop configuration file</a> <b>UPROG.dsk</b> by a new one with the name <b>&lt;file&gt;</b> and the extension <b>.dsk</b> . The desktop configuration file stores the computer screen configuration, i.e., positions, dimensions, colors and fonts of all opened windows; it resides in the ChipProgUSB folder. The new ChipProgUSB desktop configuration will be in force right after the command line execution.
<b>-ES&lt;file&gt;</b>	This key executes a script file, whose name follows the key <b>-ES</b> , right after launching the ChipProgUSB application. If the command line does not include the <b>-ES</b> key, the ChipProgUSB application searches for the script file named <b>'Start.cmd'</b> in the programmers's working folder and, if such a script file exists, it executes this script.

## 4.4 On-the-Fly Control

The **On-the-Fly Control** feature was introduced in the ChipProgUSB software version 6.00.00 and does not exist in older software versions.

Use of the **On-the-Fly Control** is very similar to [command line](#) control but this utility enables controlling a ChipProg programmer that is already launched and running, without stopping and restarting it. **On-the-Fly Control** can issue commands allowing any operation that can be executed on the target the device, including Read, Program, load a [project](#), launch a [script](#), etc. With the **On-the-Fly Control utility** you can control a working ChipProg from the Windows batch files of third-party graphical packages such as LabVIEW.

The **On-the-Fly Control utility** is an alternative to the more advanced [Application Control Interface \(DLL control\)](#); use of the latter requires some programming skills.

The **OFControl.exe** executable file resides in the folder where the ChipProgUSB is installed. It is recommended that you keep it in this folder and launch it from this folder. Once launched, the utility

does not modify its working directory..

After completion, the **On-the-Fly Control utility** issues [return codes](#). The code will be 0 (zero) in case of success. Specific error codes are listed in the **UPControl return codes** section. The program dumps error descriptions to the [Console](#) window and, optionally, to the [log file](#) and/or Windows clipboard.

Upon completing the **On-the-Fly Control** job the ChipProg keeps working unless the utility has not been launched with the key **-X**. You may re-launch the **On-the-Fly Control utility** to control the same device programmer but remember that only one On-the-Fly Control utility can feed each working device programmer at a time. So, if you launch a second copy of the **OFControl.exe** file while the ChipProg device programmer is under control of a previously launched copy of the utility, the second copy will not "find" the device programmer.

### The On-the-Fly Control command line format:

#### OFControl.exe [Options] [@<Option File>] [Options]

An option begins with one of two characters: either '/' (slash) or '-' (hyphen), followed by the reserved names listed below. The '/' (slash) and '-' (hyphen) have the same effect; there is no difference whatever. For example, '/L', '-P'. Though the [options](#) in the command line may follow each other in any order, the utility will execute them in a certain logical order. For example, operations with a target device will be executed only after loading a project and launching a script, regardless of the option order in the command line. There is one exception for the **-F<device operation list>** and **-A options**. These options define an order of operations with the target device and so they must be executed in accordance with their order in the command line.

**Note:** In the descriptions of the command line option formats, optional parameters are shown in square brackets []; in the actual option notation these brackets should be omitted. The angle brackets below <> serves for a clearer presentation only and should be omitted in the option notation. For example, instead of -G[+] use -G+; instead of -G[+][<C:\Temp\UPC.log] use -G+C:\Temp\UPC.log. Enter topic text here.

If a file name in the option includes spaces, the full name with the path should be used. Any additional information belonging to the option should follow it with no spaces. For example, -L"H:\Program Files\ChipProgUSB\6\_00\_00\UprogNT2.exe /g". Here the file name and path is framed with the quotation characters (") and there is no space between the /L and the option's ending.

The @<Option File> construction refers to the text file from which the **On-the-Fly Control utility** should fetch a number of options. Each option in such a file can be listed as a separate string. For example: :

```
UPControl.exe -D @response.txt -WK
```

Lines in the option file beginning with the semicolon sign (;) are treated as comments and ignored. A commented example of the file **response.txt** is listed in the topic [Option File example](#).

## 4.4.1 On-the-Fly command line options

### Options of the OFControl.exe command line

The command line format is: **OFControl.exe [Options] [@<Option File>] [Options]**

**Note:** In the descriptions of the command line option formats optional parameters are shown in square brackets [], in real option notation these brackets should be omitted. The angle brackets below <> serves for a clearer presentation only and should be omitted in the option notation. For example, instead of the -G[+] use the -G+; instead of -G+[<C:\Temp\UPC.log] use the -G+C:\Temp\UPC.log.

Option	Description
<b>-D</b>	Include extended information to the Console dump and in the log file if it is specified. This option is helpful for <b>On-the-Fly Control</b> utility debugging.
<b>-G[+][&lt;log file name and path&gt;]</b>	<p>Duplicate records outputting to the <b>ChipProgUSB Console</b> window to a log file. If the + sign follows the -G option name the information will be appended to the end of the log file, if it exists. Absence of the + sign will force creation of a new log file. The default name of the log file is <b>OFControl.log</b> and it resides in the <b>ChipProgUSB</b> working folder but you can specify a new file name and location.</p> <p>Examples:</p> <ul style="list-style-type: none"> <li>-G - create a new log file, named OFControl.log, in the OFControl.exe working folder.</li> <li>-G+ - append records to the OFControl.log file if it exists. If it doesn't exist, create it and append records to the file.</li> <li>-G+C:\Temp\OFC.log - append records to the C:\Temp\OFC.log file if it exists. If it doesn't exist, create it and append records to this file.</li> </ul>
<b>-WK</b>	Keep the <b>On-the-Fly Control</b> running until any key on the keyboard is pressed. This allows looking up the utility output in the <a href="#">Console</a> window before it exits.
<b>-L&lt; ChipProgUSB executable file name and command line options&gt;</b>	<p>Launch the <b>ChipProg</b> device programmer if it is not running. If it was already launched the option will be ignored. The <b>On-the-Fly Control</b> utility executes the -L option before any others specified in the command line: before loading a project, launching scripts, or any operations with the device. The -L option is incompatible with use of the -R option (see below).</p> <p>Example: -L"UProgNT2.exe /g1"</p>
<b>-R&lt;device programmer's serial number&gt;</b>	If more than one <b>ChipProg</b> device programmers are working under control of the PC in the gang mode, connect and drive the unit whose serial number is specified by this option. This option is incompatible with use of the -L option. If more than one programmer is working under control of the PC and the <b>On-the-Fly Control</b> utility does not include the -R option, the utility returns an error (#14).
<b>-C</b>	Copy an error text to the Windows clipboard. If the <b>On-the-Fly Control</b> utility completes and returns the code = 0, then an error has taken place (with the exception of the reaction to the -T option, see below). If the command line includes the -C option, the error description will be copied to the clipboard; otherwise the clipboard contents remain unchanged.

	<p>If more than one operation on the target device specified in the <b>On-the-Fly Control</b> command line returns errors, then, if the command line also includes the <b>-I</b> option (ignore errors), descriptions of all the errors will be copied to the Windows clipboard.</p>
<b>-M[=&lt;timeout in seconds&gt;]</b>	<p>Specify a timeout in seconds of waiting for readiness of the device programmer before certain events: loading the project, launching scripts and a chain of the programming operations and quitting triggered by the <b>-X</b> option. If the <b>-M</b> option is not specified, the <b>On-the-Fly Control</b> utility does not check whether the <b>ChipProgUSB</b> is in the stop mode so an attempt to launch a programming function will cause quitting the utility with an error.</p> <p>If the <b>-M</b> option is specified without the <b>[=&lt;timeout in seconds&gt;]</b> parameter then the <b>On-the-Fly Control</b> utility will indefinitely wait for the programmer readiness. In this case you can break the utility execution and quit by pressing the <b>Ctrl+C</b> keys.</p>
<b>-B</b>	<p>Stop an operation with the device. If the <b>ChipProg</b> executes a programming function (Read, Program, Verify, etc.), the operation will be interrupted. This action takes place prior to all the actions specified by the options <b>-P</b>, <b>-S</b>, <b>-F</b>, <b>-X</b>. It is possible, however, that the <b>-B</b> option does not cause a break of an operation on the target device. This happens when the utility issues an interactive operation error dialog that requires an action of the operator. In this case, the <b>On-the-Fly Control</b> utility exits with an error code.</p>
<b>-P&lt;project file&gt;</b>	<p>Load a specified <a href="#">project</a> file. Project files with <b>.UPP</b> extensions include all the information and settings for a programming session (device type, file(s) to be written to the device, customized device and algorithm parameters, interface settings, device serialization options, scripts, etc.).</p> <p>Before loading the project the <b>On-the-Fly Control</b> utility waits until the programmer stops the operations on the device (see the <b>-M</b> option). If the <b>-P</b> option is specified in the <b>On-the-Fly Control</b> command line along with the <b>-S</b> and/or <b>-F</b> options, then the project loads before launching scripts and any operations with the target device.</p> <p>Example: -P"C:\Prog\Projects\Antenna-01 Test.upp"</p>
<b>-S&lt;script file&gt;</b>	<p>Launch a specified <a href="#">script</a>. Before starting a script the <b>On-the-Fly Control</b> utility waits until the programmer stops the operations on the device (see the <b>-M</b> option). By default the <b>On-the-Fly Control</b> utility waits for the the script completion. To allow the <b>On-the-Fly Control</b> utility to continue working while the script is running, add the <b>-NWS</b> option to the option list.</p> <p>Example: -S"D:\Prog Scripts\Checksum.cmd"</p>
<b>-NWS</b>	<p>Do not wait for completion of the <a href="#">script</a> specified by the <b>-S</b> option.</p>

<p><b>-F&lt;function list&gt;</b></p>	<p>Execute listed operations (functions) with the target device. Names of the functions in the list should be separated by semicolons (;). In order to execute the <b>Auto Programming</b> function the <b>-F</b> option should be followed by an asterisk character (*).</p> <p>If the command line includes more than one <b>-F</b> option they will be executed in the order in which they are specified in the command line.</p> <p>If the <b>-F</b> option(s) is (are) specified in the command line along with the options <b>-P</b> (load project) and/or <b>-S</b> (launch script) then all the functions specified by the <b>-F</b> option(s) will start after loading the project and/or launching the script.</p> <p>By default the <b>On-the-Fly Control</b> utility waits for function completion. To enable the utility to keep running while the function specified by the <b>-F</b> option is also executing, add the <b>-NWF</b> option to the command line. In this case you may include only one <b>-F</b> option in the command line.</p> <p>If the <b>-F</b> option specifies a sub-function displayed in the drop-down menus of the <b>Program Manager</b> function tree, then specify both the menu name and the function itself, separated by the '^' character. For example: <b>-FProgram</b> (for the Code Memory chip layer) but <b>-FData Memory^Program</b> (for the Data Memory) .</p> <p>Examples:</p> <ul style="list-style-type: none"> <li>-F* - launch the Auto Programming function.</li> <li>-FErase;Blank Check;Program;Verify - erase the device, check if it is blank, write the file from the programmer buffer and compare the buffer and device memory contents.</li> <li>"-F*;Verify;Device Parameters^Program HSB and XAF" - execute the Auto Programming function, then compare the buffer and device memory contents, then launch the function Program HSB &amp; XAF from the Device Parameters sub-menu.</li> </ul>
<p><b>-NWF</b></p>	<p>Do not wait for completion of the function specified by the <b>-F</b> option. This option is incompatible with the <b>-X</b> option.</p>
<p><b>-I</b></p>	<p>Ignore errors that occur during programming operations. By default the <b>On-the-Fly Control</b> utility stops operations with the target device in case of any error. The <b>-I</b> option enables the operations regardless of the result that allows logging of all the errors that occurred.</p>
<p><b>-T[+][W=&lt;delay in milliseconds&gt;]</b></p>	<p>Get the programmer status ["Ready" or "Busy"]. The <b>On-the-Fly Control</b> utility returns the code 0 (zero) if the <b>ChipProg</b> stops and is ready for executing a programming operation, or 1 if the programmer is in the process of operating with the target device ("Busy").</p> <p>If the '+' sign is present in the <b>-T</b> option declaration then, if the programmer operates on the target device, a current function name (Read, Program, etc.) will be output to the Console window along with the percentage of the function being executed. For example: Program, 87%.</p>

	<p>The optionally specified [<b>W=&lt;delay in milliseconds&gt;</b>] parameter sets a delay before getting the programmer status. Delays allow checking the programmer status within a settable period of time.</p> <p>Examples:</p> <ul style="list-style-type: none"> <li>-T - get the programmer status "Ready" or "Busy"</li> <li>-TW=1000 - wait for 1 sec, then get the programmer status "Ready" or "Busy"</li> <li>-T+ - get the programmer status "Ready" or "Busy". Then output to the Console window the name of the currently executed function and the percentage of its completion. An example of the function status string: Read 56%.</li> </ul>
<b>-V=[0   1]</b>	<p>Hide (-V=0) or make it visible (-V=1) in the <b>ChipProgUSB</b> main window.</p> <p>If the <b>ChipProgUSB</b> main window is hidden, the programmer will be invisible among other open applications in the <b>Applications</b> tab of the <b>Windows Task Manager</b>. So, in order to close the running <b>ChipProgUSB</b> program you will have to open the <b>Process</b> tab of the Task Manager, then locate and highlight the programmer executable name (<b>UprogNT2.exe</b>) and click the <b>End Process</b> button.</p>
<b>-X</b>	<p>Stop the programmer and quit the program. To quit the <b>ChipProgUSB</b> program, the programmer must complete all the previously launched operations on the device. So the <b>On-the-Fly Control</b> utility waits for completing the current programming operation for a timeout period specified by the <b>-M</b> option. If this option is omitted or the timeout period expired the <b>On-the-Fly Control</b> returns an error code.</p>
<b>-? or -H</b>	<p>Output a brief description of the <b>On-the-Fly Control</b> utility options and quit.</p>

#### 4.4.2 On-the-Fly utility return codes

After completion, the **On-the-Fly Control** utility issues a return code of 0 (zero) in case of success. Otherwise it issues one or more of the error codes listed below. It returns the codes to the application or to a batch-file that called the utility. There is one exception that is associated with the option **-T**. Then the utility returns 0 if the programmer was stopped and 1 if it is operating on the target device.

The utility prints errors on the [Console](#) and, optionally, writes them to the log file and/or Windows clipboard.

##### Return codes:

<b>0</b>	Successful completion.
----------	------------------------

1	The -T option was specified and the programmer is busy executing an operation on device.
2	Wrong option, parameter or parameter format in the <a href="#">command line</a> .
3	Error calling a Windows API function; it could be caused by an abnormal exit of the programmer software.
4	The programmer application was closed while the On-the-Fly Control utility has been waiting for a response. Possibly a user has forced closing the program.
5	The timeout, which was set by the -M option for stopping the programmer, has expired.
6	The programmer was launched in the gang mode but an option in the On-the-Fly Control utility tried launching a function not applicable for <a href="#">gang programmers</a> .
7	Cannot execute a required action because the programmer is busy with operation on the target device.
8	Failed to load the project specified by the -P option.
9	Failed to launch the script specified by the -S option.
10	General error.
11	The programming function specified in the -F option does not exist for the selected device.
12	An error occurred while the programmer operated with the target device.
13	The programmer could not complete an operation and close the program after receiving the -X option request.
14	More than one device programmers is running. This requires the -R option use.

### 4.4.3 On-the-Fly Control example

[; Launch the programmer in the diagnostic mode unless it is already working](#)

```
-L"C:\Program Files\ChipProgUSB\5_25_00\UProgNT2.exe /g1"
```

[; Append records to the log](#)

```
-G+
```

[; If the programmer is busy wait for 30 seconds max](#)

```
-M=30
```

[; Load the project. The FuelPump-08.upp project file locates in the folder D:\Projects](#)

```
-PD:\Projects\FuelPump-08.upp
```

[; Execute the csm-16.cmd script located in the folder D:\Scripts](#)

```
-SD:\Scripts\csm-16.cmd
```

; Execute auto programming using parameters defined by the FuelPump-08.upp project  
-F\*



## 4.5 Script Files

The ChipProgUSB program can execute so-called **script files** in a way similar to how the MS DOS executes the batch files. The script file mechanism was implemented in the ChipProgUSB in order to automate usage of the ChipProg programmers. By means of script files you can, for example, automate loading files to the programmer buffers, calculating checksum, launching device programming, pausing programming in case of an error, manipulating windows and performing many other operations. It is also possible to display various messages in the [Console window](#) or other special windows generated by the script itself, including displaying graphical data in special windows; to create user's custom menus, etc. The script language is similar to C program language; almost all C constructions are supported, except for structures, conjunctives and pointers. There are also many built-in functions available, such as printf(), sin() and strcpy(). The extension of script source file is **.CMD**.

When the ChipProgUSB program starts, it searches for the script with the reserved name **START.CMD**. So, if you wish the ChipProgUSB program would automatically perform some operations immediately after you launch the program, you can create a special script. The ChipProgUSB program begins searching for the **START.CMD** in the current directory on the disc, then it searches for this script in the directory where the ChipProgUSB.exe file resides. If the **START.CMD** is not located then a default ChipProg shell will open.

The **scripts** controls and associated dialogs and windows are concentrated under the [Script menu](#). The major dialog that controls scripts is the [Script Files dialog](#).

See also:

[Simple example of a script file](#)

How to write a script file

How to start a script file

How to debug a script file

[Description of Script Language](#)

[Script Language Built-in Functions](#)

[Script Language Built-in Variables](#)

[Difference Between the Script Language and the C Language](#)

[Alphabetical List of Script Language Built-in Functions and Variables](#)

### 4.5.1 The Script Files Dialog

This dialog is used for controlling the [Script Files](#), it allows to **start**, **stop** and **debug** scripts.



In the upper window of this dialog you see the list of loaded script files with the current state of each file. Any script can be in one of the following states:

<b>State of File</b>	<b>Description</b>
<b>Stopped</b>	Execution of the script file is temporarily stopped.
<b>Running</b>	The script file is being executed.
<b>Waiting</b>	The script is waiting for an event. This state is initiated by calling certain wait functions in the script file text (for example, <b>Wait</b> ).
<b>Cancelled</b>	The script execution is terminated, but the script file is not yet unloaded from the memory.

To select a script file, highlight its name in the window. The four buttons on the right of the list control the highlighted script:

<b>Button</b>	<b>Description</b>
<b>Terminate</b>	Unloads the selected script file if it can be unloaded. Otherwise, it sets up the <b>Unload Request</b> flag for the selected script that then goes to the <b>Cancelled</b> state.
<b>Terminate All</b>	Unloads all script files visible in the window.

<b>Restart</b>	Restarts a highlighted script file.
<b>Debug</b>	Switches to the Debugger mode for the highlighted script file. This command stops execution of the script and opens it in the source window of the script for debugging. If the script is in the wait state, then execution will immediately stop after the script returns from the <b>Waiting</b> status.

When you use several script files simultaneously and unload or restart some of them, remember that script files can share global data and functions. If one script accesses data or the functions belonging to another one that is already unloaded, then the script interpreter will issue error messages and the active script file will be also be unloaded (terminated).

The buttons and fields in the lower part of the dialog box control the script files starting:

<b>Element of dialog</b>	<b>Description</b>
<b>Script File Name</b>	Specifies a name of the script file to be loaded. You can either typed in the file name with a full path to the box or to take it from the drop-down history list or browse it from a computer disc.
<b>Browse</b>	Opens the <b>Load/Execute Script File</b> dialog for locating and loading script files into the <b>Script File Name</b> box.
<b>Defines</b>	Defines the processor text variables for compilation. For more information, see below the <b>Processor text variables</b> .
<b>#include-file Directories</b>	Specifies the directories in which the script file will search for the files specified in the <b>#include &lt;file_name&gt;</b> directive(s). To specify more than one directory, separate them by semicolons. The current directory is scanned as well.
<b>Debug (open Script Source window)</b>	If this box is unchecked, a script file automatically starts execution upon the file loading. If the box is checked, then upon loading a script file, the program immediately opens the window for debugging the script. See also How to Debug a Script File.
<b>Auto-save Script File Sources</b>	If this box is checked when you click the <b>Start</b> button ChipProgUSB automatically saves the source texts of all script files visible in the <b>Script Source</b> windows.
<b>Start</b>	Starts the script file specified in the <b>Script File Name</b> box.

#### **Processor text variables**

The content of the **Defines** text box is equivalent to the **#define** directive in the C language. For example, if you type **DEBUG** in this text box, the result will be as if the **#define DEBUG** directive is placed in the first line of the script source text.

You can specify values for variables. For example, **DEBUG=3** is equivalent to **#define DEBUG 3**.

You can list several variables in a line and separate them with semicolons. For example:

```
DEBUG; Passes=3; Abort=No
```

Also, see Predefined Symbols at the Script File Compilation.

## 4.5.2 How to create and edit script files

A **script file** is similar to a source program text written in programming language (C, for example), e.g. a

script file can be created and edited either in the [Editor window](#) by the ChipProgUSB built-in editor or by any other editor. You can allocate script files in your work directory or in the directory where the ChipProgUSB program is installed.

Normally the Editor toolbar that collects all the edit function buttons is hidden. To create a customized editor toolbar right click on the blank area of the main toolbar, select the Customize line in the drop-down menu and check the boxes of the editor functions which you would like to make visible.

To open a new script file for editing open the **Script menu > Editor window > New**. This will open a blank window below. Right clicking within the window pops up the **Editor command menu** that includes the buttons which you can bring up to the local **Editor toolbar**. Here the toolbar is shown above the window.

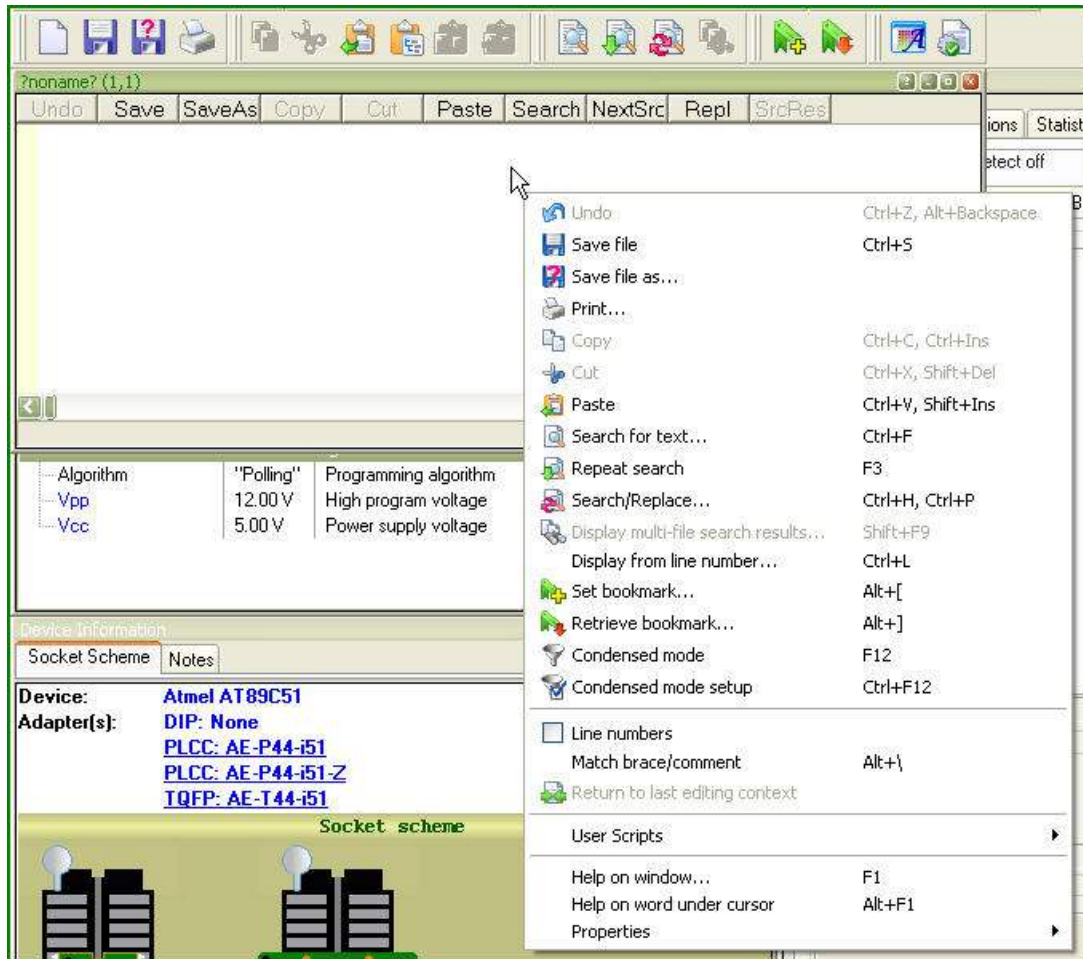





Now you can compose your script right in the window.

**Note that you should not use the punctuation characters (braces, dash, etc.) in the script file name.**

When you complete the file composing click on the **Save** button on the window local toolbar or on the **Editor toolbar** and the program will prompt you to name the script file and to specify its location.







#### 4.5.2.1 The Editor Window







Commands of this menu refer to the currently active [Edit](#) window.

Button	Command	Description
	<b>New</b>	Opens the <a href="#">Editor window</a> for a new script file.
	<b>Open...</b>	Opens the <b>Open file</b> dialog to load a script file for editing. The file name and path can be either entered or browsed here.
	<b>Save</b>	Saves the file from the currently active window to a disc.
	<b>Save As...</b>	Opens the <b>Save file as...</b> dialog.
	<b>Print</b>	Opens the standard <b>Print</b> dialog for the default printer. You can print an entire file or a selected text block.
	<b>Properties..</b>	The common properties for open files.

#### 4.5.2.2 Text Edit

Commands of this menu refer to the currently active [Edit](#) window.

<u>Button</u>	<u>Command</u>	<u>Description</u>
	<b>Undo</b>	Undoes the last text editing action executed in this window. For example, if the last action deleted a line, then the deleted line will be restored. The number of steps provided by the Undo function is set in the of the <b>Configure &gt; Editor Options &gt; <a href="#">General</a> tab</b> .
	<b>Copy</b>	Copies the marked block to the clipboard. The text format in the clipboard is standard and the copied block is accessible to other programs.
	<b>Cut</b>	Removes the marked block to the clipboard..
	<b>Paste</b>	Copies the block from the clipboard, starting at the cursor position.
	<b>Clipboard History/Repository</b>	Opens the <b>Clipboard History/Repository</b> dialog.
	<b>Append to Clipboard</b>	Copies and appends the marked block of text to the block in the clipboard.
	<b>Cut &amp; Append to Clipboard</b>	Cuts the marked block of text and appends it to the block in the clipboard.
	<b>Fast Copy</b>	Copies a block to a specified position in the same window.
	<b>Fast Move</b>	Moves a block from one position in the window to another position in this window.
	<b>Block Off</b>	Unmarks a marked text block.
	<b>Search</b>	Opens the <a href="#">Search for Text</a> dialog.
	<b>Next Search</b>	Repeats search with the parameters used in the previous search.

	<b>Replace</b>	Opens the <a href="#">Replace Text</a> dialog.
	<b>Display Multi-file Search Results</b>	Re-opens the last multi-file search results in the <a href="#">Multi-File Search Results</a> dialog.
	<b>Display from line number...</b>	Opens the <a href="#">Display from Line Number</a> dialog for you to specify a line number. Source text will be displayed from this line.
	<b>Set bookmark...</b>	Opens the <a href="#">Set Bookmark</a> dialog to set a local bookmark.
	<b>Retrieve bookmark</b>	Opens the <a href="#">Retrieve Bookmark</a> dialog to retrieve a local bookmark.
	<b>Condensed mode</b>	Toggles the <a href="#">Condensed display mode</a> on and off.
	<b>Condensed mode setup</b>	Opens the <a href="#">Condensed Mode Setup</a> dialog.
	<b>Line numbers on/off</b>	Toggles the availability of the line numbers on and off.
	<b>Return to last editing context</b>	Activates the most recently edited <b>Source</b> window, and places the cursor in its final position during the edit.

#### 4.5.2.2.1 The Search for Text Dialog

This dialog sets complex criteria and parameters for searching text in files. This dialog and the **Replace Text** dialog have a number of common parameters, which function in the same way in both dialogs. To specify file names, you can use one or several wildcards. Also, the names may contain paths. You can search in more than one file at once by using parameters of the **Multi-File Search** area.

<b><u>Element of dialog</u></b>	<b><u>Description</u></b>
<b>String to Search for</b>	Specifies the text string to search for.
<b>Case Sensitive</b>	This box is unchecked by default. Checking this box specifies that the case of the string is to be matched.
<b>Whole Words Only</b>	This box is unchecked by default. If checked, the editor will search only for whole words: the string will be found only if it is enclosed between punctuation or separation characters (spaces, tabulation symbols, commas, quotation marks, etc.).
<b>Regular Expressions</b>	This box is unchecked by default. Checking of this box specifies that the search string is a <a href="#">regular expression</a> .
<b>Global</b>	Search the entire file for the string. Enabled by default.
<b>Selected Text</b>	Search the string in the selected block.
<b>From Cursor</b>	Search from the current cursor position.
<b>Entire Scope</b>	Search from the beginning or end of the file (depending on the search direction). Enabled by default.
<b>Perform Multi-File Search</b>	If this box is checked the editor will search in all project files (see the notes below). If the box is unchecked, then the search will be performed in the current <b>Source</b> window only.
<b>Search All Source</b>	If this box is checked the editor will search in all the source files included in

<b>Files in Project</b>	the project.
<b>Include Dependency Files</b>	If this box is checked the editor will search in all the source files included in the project and all files on which the source files depend, whether explicitly or implicitly. For C language, these are the header files (*.h).
<b>Search Wildcard(s)</b>	Check this box to search for one or several wildcards specifying the files to be searched. Separate wildcards with semicolons. No quotes are required to denote Windows-style long names. Example: *.txt;*.c;c:\prog\*.h. This option and the <b>Search All Source Files in Project</b> option act independently of each other: you can search in all files of the project AND in other files that comply with the specified wildcard(s).
<b>Search Subdirectories</b>	If this box is checked the editor will search in subdirectories of all the directories specified by the <b>Search All Source Files in Project</b> option and by wildcards.
<b>Starting Path</b>	Begin search from the directory specified in this text box. This directory serves as the common path and is useful when there are several wildcards such as the following ones:  <code>c:\prog\text\source\*.txt;c:\prog\text\source\*.doc</code>  In this case, make use of wildcards (*.txt;*.doc) and common path (c:\prog\text\source).

#### Notes

1. When you search in the file opened in the **Source** window, then only the window buffer will be searched, not the file on disk.
2. Multi-file search is performed in all source files of the project. Upon finishing, the [Multi-File Search Results](#) dialog remains open.

#### 4.5.2.2.2 The Replace Text Dialog

This dialog sets the parameters for the search-and-replace operation. This dialog and the **Search for Text** dialog have a number of common parameters, which function in the same way in both dialogs. To specify file names, you can use one or several wildcards. Also, the names may contain paths. You can search in more than one file at once by using parameters of the **Multi-File Search** area.

<b><u>Element of dialog</u></b>	<b><u>Description</u></b>
<b>Text to Search for</b>	Specifies the text string to look for (search string).
<b>Replace with</b>	Specifies the text string to replace the found one.
<b>Case Sensitive</b>	This box is unchecked by default. Checking this box specifies that the case of the string is to be matched.
<b>Whole Words Only</b>	This box is unchecked by default. If checked the editor will search only for whole words: the string will be found only if it is enclosed between punctuation or separation characters (spaces, tabulation symbols, commas, quotation marks, etc.).
<b>Regular Expressions</b>	This box is unchecked by default. Checking of this box specifies that the search string is a <a href="#">regular expression</a> .
<b>Prompt at Replace</b>	This box is checked by default and if it is checked the editor will always pop up the <a href="#">Confirm Replace</a> dialog requiring your permission to replace the found text. If unchecked the editor will automatically replace the searched-and

	found text.
<b>Global</b>	Search the entire file for the string. Enabled by default.
<b>Selected Text</b>	Search the string in the selected block.
<b>From Cursor</b>	Search from the current cursor position.
<b>Entire Scope</b>	Search from the beginning or end of the file (depending on the search direction). Enabled by default.
<b>Perform Multi-File Search and Replace</b>	This box is checked by default and if it is checked the editor will search in all project files (see the notes below). If the box is unchecked, then the search will be performed in the current <b>Source</b> window only.
<b>Search All Source Files in Project</b>	If this box is checked the editor will search in all the source files included in the project.
<b>Include Dependency Files</b>	If this box is checked the editor will search in all the source files included in the project and all files on which the source files depend, whether explicitly or implicitly. For C language, these are the header files (*.h).
<b>Search Wildcard(s)</b>	Check this box to search for one or several wildcards specifying the files to be searched. Separate wildcards with semicolons. No quotes are required to denote Windows-style long names. Example: *.txt;*.c;c:\prog\*.h. This option and the <b>Search All Source Files in Project</b> option act independently of each other: you can search in all files of the project AND in other files that comply with the specified wildcard(s).
<b>Search Subdirectories</b>	If this box is checked the editor will search in subdirectories of all the directories, which are specified by the <b>Search All Source Files in Project</b> option and by wildcards.
<b>Starting Path</b>	Begin search from the directory specified in this text box. This directory serves as the common path and is useful when there are several wildcards such as the following ones:  <pre>c:\prog\text\source\*.txt;c:\prog\text\source\*.doc</pre> In this case, make use of wildcards (*.txt;*.doc) and common path (c:\prog\text\source).

#### Notes

1. When you search in the file opened in the **Source** window, then only the window buffer will be searched, not the file on disk.
2. Multi-file search is performed in all source files of the project. Upon finishing, the [Multi-File Search Results](#) dialog remains open.

#### 4.5.2.2.3 The Confirm Replace Dialog

This dialog requires your permission to replace a found string. You can turn the prompt on/off by checking/clearing the **Prompt at Replace** box in the [Replace Text](#) dialog.

<b>Button</b>	<b>Function</b>
<b>Yes</b>	Replace the found string.
<b>No</b>	Cancel this replacement. If the procedure is started with the <b>Change All</b> button for all occurrences in the search area, then the search-and-



	replace process will continue.
<b>Non-Stop</b>	From this moment, replace all found strings in this file without prompt.
<b>Cancel</b>	Cancel the search-and-replace process.
<b>Skip this File</b>	Stop search in this file and switch to the next one.
<b>Replace in All Files</b>	Replace all occurrences in all other files without confirmation.
<b>Move cursor to the Yes/No Buttons</b>	When this box is checked the cursor will be automatically placed on the <b>Yes</b> button on each inquiry for confirmation.

#### 4.5.2.2.4 The Multi-File Search Results Dialog

This dialog displays the multi-file search results. To learn about the multi-file search, see the [Search for Text](#) dialog.

The **List of Matched Files** shows the files where the search string is found. The file name is on the left and its directory is on the right. The line with green text right under this box displays information about the file selected in the box. "File in memory" means that the file is opened in the **Source** window. General information from FAT means the file is on disk, not loaded. The **Preview** area shows the source line with the found text string.

The **Sort Files by** area includes a radio button with four file sorting options. When the **Consider Directory** box is checked, the files are sorted with respect to their directories.

The **Edit** button opens the selected file in the new **Source** window and places the cursor on the line with the found string. The found string is marked with the background color. To check if there are other occurrences of the sought string in this file, press **Ctrl+R** or use the **Next Search** command of the **Edit** menu.

The **Close** button closes the dialog but the results are not lost. To reopen the dialog use the **Display Multi-file Search Results** button. You can also use the same command of the **Edit** menu or press **Shift+F5**. The files in the **List of Matched Files** box, which are opened in the **Source** window, will be marked with asterisks on the left.

#### 4.5.2.2.5 Search for Regular Expressions

The text editor supports "regular expressions," which can be used to search for special cases of text strings. Regular expressions contain the control characters in the search argument string:

<b>?</b>	Means any one character in this place. Example: if you specify <i>?ell</i> as the search string, then "bell," "tell," "cell," etc. will be found.
<b>%</b>	Means the beginning of line. The characters following '%' must begin from column 1. Example: <i>%Counter</i> - find the word "Counter," which begins at the first column.
<b>\$</b>	The end of line. The characters preceding the '\$' should be at the last positions of the line. Example: <i>Counter\$</i> - find the word "Counter" at the line end.
<b>@</b>	Match the next character literally; '@' lets you specify the control characters as usual letters. Example: <i>@?</i> - search for the question mark character.
<b>\xNN</b>	The hexadecimal value of the character. Example: <i>\xA7</i> - find the character with the hexadecimal code of A7.
<b>+</b>	Indefinite number of repetitions of the previous character. For example, if you specify <i>1T+2</i> , then the editor will find the lines containing "1" followed by "2", which are separated with any number of repetitions of the letter T.
<b>[c1-c2]</b>	Match any character in the interval from c1 to c2. Example: <i>[A-Z]</i> means any letter from A to Z.

<b>[~c1-c2]</b>	Match any character whose value is outside the interval from c1 to c2. Example: <b>[~A-Z]</b> means any character except for the uppercase letters.
<b>text1 text2</b>	The " " character is the logical "OR" and the editor will look for either <b>text1</b> or <b>text2</b> . Example: <b>LPT COM CON</b> means search for "LPT" or "COM" or "CON."

#### 4.5.2.2.6 The Set/Retrieve Bookmark Dialogs

Bookmarks help you to return to a marked cursor position in a source file.

You can set and retrieve up to 10 local bookmarks. Every local bookmark has an individual numbered button assigned to it.

To open the **Set Bookmark** dialog, press **Alt+[**. To open the **Retrieve Bookmark** dialog, press **Alt+]**. To set/retrieve a bookmark, press its numbered button. The number of the bookmarked line, the bookmark position in the line (in brackets) and the text of the line are shown at the right of the button.

Local bookmarks are stored in the configuration file and you can work with them in the next session.

#### 4.5.2.2.7 Condensed Mode

In the Condensed mode, only lines that satisfy a specified criterion are displayed in the window. There are two available criteria:

- the line must contain a given sub-string;
- the first non-space character in a line must be at a specified position (column).

Examples: (a) with the sub-string criterion and the sub-string set to "counter," only the lines containing the word "counter" will be displayed; (b) with the second criterion and the position set to four, only the lines in which text begins at column 4 will be displayed.

The Condensed mode brings the lines having some common feature to "one place." If you attentively follow a rule to begin the declaration of data at position 2, procedures at position 3, and interrupt handlers at position 4, then the Condensed mode will help you to find a necessary declaration. If you comment certain lines with the same or similar comments and use the Condensed mode with sub-string, you will be able to benefit from your composing style. In the Condensed mode, you can move the cursor just as in the normal mode.

##### How to control

The criterion for display is set in the **Main menu > Script > Text Edit > Condensed Mode Setup** dialog. To toggle the Condensed mode on/off, use the **Edit** menu command, the **Condensed Mode** command of the local menu or the **F12** hotkey. To exit the Condensed mode, press **Esc**. When you exit, the cursor returns to the position at which it was before the mode was turned on. To exit the mode and remain in the line from which you moved the cursor while in the mode, press **Enter** or begin editing the line.

#### 4.5.2.2.8 The Condensed Mode Setup Dialog

This dialog sets up the parameters for the [Condensed mode](#) of the **Source** window.

The **Display Lines of Text** area has radio buttons for switching between two alternative criteria for condensing text in the **Source** window: **Containing String** and **Where First Non-blank Column Is**:

1. If you check the **Containing String** radio button the Source window will display only the lines with text that match the sub-string specified in the text box at the right. Additionally, you can specify that the case should be matched the case, that whole words only should be used, and that the sub-string is a [regular expression](#).

2. If you check the **Where First Non-blank Column Is** radio button, the Source window will display the lines

where text begins from the position specified in the **Column** box. Then you should select one of four options by checking an appropriate radio button:

- **Equal to** - the first non-space character should be exactly in the specified column. For example, if you specify position number 2, the window will display only the lines whose text begins in column 2.
- **Not Equal to** - the first non-space character should be in any column except the position specified here. For example, if you specify position number 2, the window will not display all the lines beginning in this column. All other lines will be displayed.
- **Less than** - display only the lines in which text begins at a position less than the specified one.
- **Greater than** - display only the lines in which text begins at a position greater than the specified one.

When you have completed setup click **OK** to switch the **Source** window to the Condensed mode.

#### 4.5.2.2.9 Automatic Word Completion

It is normal for words (labels, names of variables) to be repeated within a limited part of a file. In such cases, the **Source** window helps you finish typing the whole word.

If the cursor is at the end of line that is being composed, then upon typing a letter, the editor scans the text above and below the current line. If a word beginning with the letters that you have just typed is found in these lines, then the editor will "complete" this word for you by writing the remaining part of the word from the current cursor position. If this word suits you, press **Alt+Right** (**Alt+<right arrow>**) and the editor will append the remaining part of the word to the text as if you have typed it yourself. If the word doesn't suit you, just continue typing and the editor will accept whatever you type. At any point during the typing, you may press **Alt+Right** to accept the editor's completion suggestion.

You can press **Alt+Right** at any time and not only when the editor offers you to complete a word. In this case, the editor will open a list of words that begin with the typed letters. If the list does not include an applicable word, just ignore the prompt. The right pane of the Source window, if it is open, also displays the word completion list.

##### How to control

To disable automatic word completion, uncheck the **Automatic Word Completion** box in the **Main menu > Configure>Editor Options> General** tab. When the box is checked, a number placed in the **Scan Range** box defines the number of lines for the editor to scan. The default is 24 lines below and 24 lines above the current line. When this parameter is greater than the total number of lines in the file (for example, 65535), then program composing will become slower because the whole file will be scanned.

#### 4.5.2.2.10 Syntax Highlighting

When the **Source** window displays the source text, it marks different C language constructions with different colors. This feature improves readability. The following constructions are highlighted separately:

- Punctuation and special characters: **() [] {} . , ;** and so on.
- Comments that begin with **//** are highlighted. Comments enclosed in the **/\* \*/** character pairs are highlighted, if the opening and closing pairs are placed in the same line.
- Strings enclosed in double or single quotation marks.
- Keywords of the C language (**for**, **while**, and so on).
- Type names of the C language (**char**, **float**, and so on).
- Library function names of the C language (**printf**, **strcpy**, and so on).

##### How to control

You can disable syntax highlighting through the **Main menu > Configure>Editor Options> General** tab>**Syntax Highlighting** flag. In addition, you can change the color for each construction. To do the latter, use any of the following items: **Main menu > Configure> Environment > Colors** tab.

#### 4.5.2.2.11 The Display from Line Number Dialog

Use this dialog to display the source file in the active **Source** window starting with a specified line. Enter the line number or select any previous number from the **History** list. The number of the first line is 1.

#### 4.5.2.2.12 The Quick Watch Function

The **Quick Watch** function works as follows: if you roll the mouse pointer over a variable name in the **Source** window or the **Script Source** window, a small box containing the value of the variable will be opened. This box disappears upon moving the mouse off the object.

#### 4.5.2.2.13 Block Operations

Block operations apply an editing action to more than one character at once. The **Source** window supports persistent blocks and performs a full range of operations with standard (stream), vertical (column) and line blocks of text.

**Non-persistent blocks** In this mode, once a block is marked, you have to immediately carry out an operation with it (delete, copy, etc.), because any movement of cursor takes the marking off the block. If a block is marked, then any entered text will replace the block with the typed text.

**Persistent blocks** In this mode, the block remains marked until the marking is explicitly removed (hot key **Shift+F3**) or the block is deleted (**Ctrl+X**). The Paste operation for persistent blocks has specifics. Two additional block operations are available for persistent blocks: fast copy and fast move. These operations do not use the clipboard and require fewer manipulations of the keyboard.

To enable the persistent block mode check the namesake box on the **Main menu > Configure>Editor Options> General tab**.

**Standard blocks** The standard (stream) block contains a "text stream" that begins from the initial line and column of the block and ends at the final line and column.

The **Standard blocks** is enabled by default.

**Line blocks** The line block contains whole lines of text. To mark a line block, put the cursor anywhere in the first line and press **Alt+Z**; then put the cursor anywhere in the last line of the block and press **Alt+Z** once more (the latter is not necessary if the block is to be immediately deleted or copied to the clipboard).

**Line blocks** are always available.

**Vertical blocks** The vertical block contains a rectangular text fragment. Characters within the block, which goes beyond the end of the line, are considered to be spaces. Vertical blocks are convenient in cases like the following example of source text:

```
char Timer0 far ;
char Timer1 far ;
char Int0 far ;
char Int1 far ;
```

Assume the word "far" is to be moved to the place right after the word "char" in each line. The stream blocks are of little help here. However the task can be easily done with one vertical block. Mark the persistent vertical block containing the word "far" in each line, place the cursor on the first letter of word "Timer0" and press **Shift+F2** (fast move the block):

```
char Timer0 far ;
char Timer1 far ;
char Int0   far ;
char Int1   far ;
```

Checking/Clearing the **Vertical Blocks** box toggles between the vertical block and the stream block modes in the the **Main menu > Configure>Editor Options> General** tab. The standard blocks are enabled by default; i.e. the **Vertical Blocks** box in the **Editor Options** dialog is unchecked by default. The line blocks are always accessible, irrespective of the status of the **Vertical Blocks** box.

To mark a block, either move the mouse while pressing its left button or use the arrow keys of the keyboard while pressing the **Shift** key. To unmark the block, press **Shift+F3**.

#### Copying / moving blocks

A marked block can be copied or moved within the same **Source** window in two ways: directly (fast copying, fast moving) and through the clipboard (Copy/Cut-n-Paste). Copying and moving blocks between the **Source** windows, or to another application should always be made through the clipboard.

**Note.** The result of copying the stream or vertical non-persistent block depends on the INSERT mode. If the mode is enabled, then the block is inserted into the text, starting at the cursor position; otherwise the copied block overwrites the text on an area of equivalent size.

#### Fast copying / moving

Fast copying (moving) the blocks in the same window directly (without the clipboard) is convenient because it requires pressing of keys only once per operation. Mark a persistent block, then place the cursor at the destination position and press **Shift+F1** to copy, or **Shift+F2** to move.

### 4.5.3 How to start and debug script files

#### Starting scripts

Scripts can be started and restarted in several ways. The easiest one uses the commands of the [Script Files dialog](#):

- to start a new script enter the file name into **Start new script file** box and click the **Start button** in the bottom part of the dialog box;
- to restart a stopped script highlight its name in the dialog window that displays all the loaded scripts and click the **Restart button**.

A script can be also started by means of the **StartCommandFile()** function executed by another running script.

#### Debugging scripts

A script can be started for an immediate execution (read above) and can be launched in the **Debug mode** that usually is necessary while you master the script and need to check if it properly works and make necessary corrections in it. To start the script debugging highlight its name in the [Script Files dialog](#) window and click the **Debug button** - the program opens the window with the script file's editable text. The window is split in two panes: the left pane displays the script text, the right one is the [AutoWatches pane](#). If you check the **Debug box** then every time when you start a script it will automatically switch to the **Debug mode**, stop the script execution and open the window with the script file.

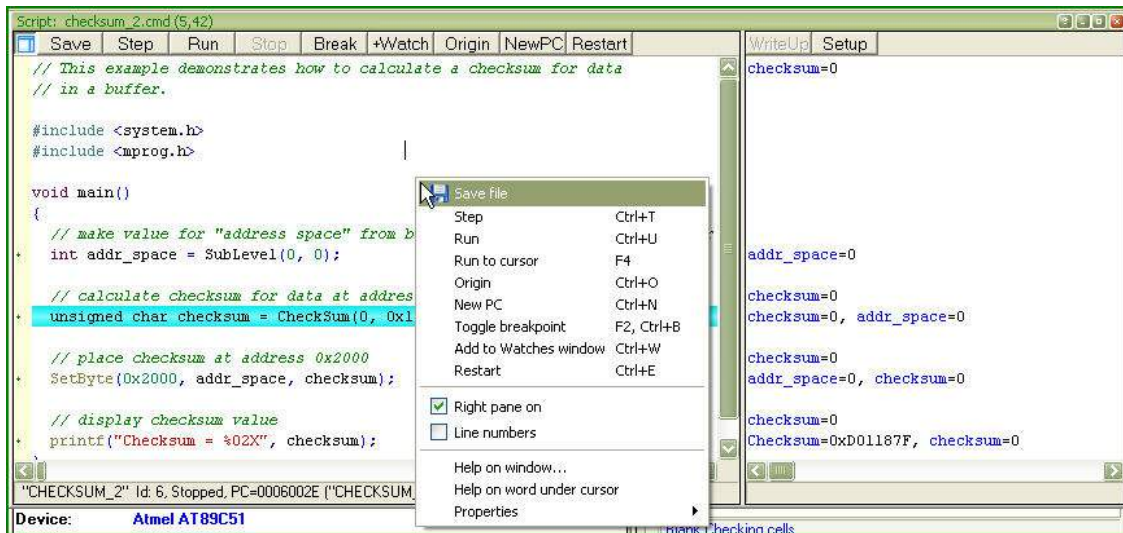

Syntax constructions and the lines, which correspond to the current PC value (blue strip) and the breakpoints (red strips), are highlighted in the script file text (for more information, see [Syntax Highlighting](#)).

#### Local menu and toolbar

The local menu window contains the following commands, most of which are duplicated by the corresponding buttons on the window toolbar:

<b>Command</b>	<b>Window Toolbar</b>	<b>Description</b>
<b>Step</b>	<b>Step</b>	Executes one operator of the script.
<b>Run</b>	<b>Run</b>	Starts continuous execution of the script in the window. Then the script execution can be broken either by hitting a set breakpoint or by the command <b>Stop</b> .
<b>Run to Cursor</b>		Executes the script up to the line where the caret is positioned (the corresponding address). Alternatively, you can double-click the line to carry out this command.
	<b>Stop</b>	Stops the running script.
<b>Origin</b>	<b>Origin</b>	Displays the source text from the line whose address corresponds to the script file Program Counter. This operation is not available when source text lines do not exist for the program addresses.
<b>New PC</b>	<b>New PC</b>	Sets the script file's Program Counter value to the address corresponding to the line where the caret is positioned.

<b>Toggle Breakpoint</b>	<b>Break</b>	Sets up or clears the breakpoint at the address corresponding to the line where the caret is positioned. When you execute the <b>Run</b> or <b>Run to cursor</b> command the program execution will be stopped at the breakpoint.
<b>Add to Watches Window</b>	<b>+Watch</b>	Opens the <a href="#">Watches window</a> (if not yet opened) and places the name at the caret position into it.
<b>Restart</b>	<b>Restart</b>	Restarts the highlighted script.

**Note.** To get help on a function or variable, point to the function or variable with the cursor and click. For more information, see [How to Debug a Script File](#) and [Script Files](#).

For customizing the ChipProg user interface and debugging purposes scripts themselves can open two types of additional windows: the [User window](#) and the [I/O Stream window](#).

#### 4.5.3.1 The AutoWatches Pane

The ChipProgUSB program displays a visible portion of the script in the **Script** window. The names of variables, called **AutoWatches**, which belong to the visible script lines, are listed together with their current values in the right pane of the window. When you scroll through the **Script** window the contents of the **AutoWatches** pane automatically refreshes.

The **AutoWatches** can be presented in the pane in the binary, hexadecimal, decimal or ASCII formats. To set the format you need to click the **Setup** button on the pane local toolbar or right click on the pane space to open the local menu.

#### 4.5.3.2 The Watches Window

While the [AutoWatches](#) pane of the Script window displays values of the script variables visible in the current window scope you may want to monitor changing other explicitly specified script variables and [expressions](#). To do so the ChipProgUSB allows opening the **Watches** windows. For each variable, the window displays its name, value, type and address, if any.

A newly opened **Watches** window has one **Main** tab. You can add custom tabs (with the **Display Options** command of the local menu) or rename any existing tabs. The tabs operate independently of each other; each tab is functionally equivalent to a separate **Watches** window. However, if needed, you can open several **Watches** windows.

Each of the above windows has the **+Watch** button on its toolbar. Clicking this button opens a dialog for adding a selected object to the **Watches** window.

##### [Grids in the Watches window](#)

For better readability the Watches window can be divided in cells by vertical and horizontal grid lines. Enable the grids to be visible within the **Watches** window by checking the corresponding boxes in the

**Configure** menu > **Environment** > **Fonts** tab.

### Local menu

The window local menu contains the following commands, most of which are duplicated by corresponding buttons on the window toolbar.

<b>Command</b>	<b>Description</b>
<b>Add Watch</b>	Adds one or more objects to the window. Opens the <b>Add Watch</b> dialog to choose an object by name. Also, you can enter an <a href="#">expression</a> as a name.
<b>Delete Watch</b>	Deletes a selected object from the <b>Watches</b> window.
<b>Delete All Watches</b>	Deletes all watches from the window.
<b>Modify</b>	Opens the <b>Modify dialog</b> to set a new value for a selected variable. Alternatively, just enter the new value.
<b>Move Watch Up</b>	Moves a selected watch up the list.
<b>Move Watch Down</b>	Moves a selected watch down the list.
<b>Display Options</b>	Opens the <b>Display Options</b> dialog to change the display settings for a selected object and also to add/delete tabs to/from the window.

#### 4.5.3.2.1 The Display Watches Options Dialog

Use this dialog to set the display options for the selected variable or [expression](#) in the **Watches** window.

<b>Element of dialog</b>	<b>Description</b>
<b>Watch Expression</b>	Contains a selected expression. The drop-down list contains the previously used expressions.
<b>Display Format</b>	Specifies the format for displaying a selected expression (binary, hexadecimal, decimal or ASCII).
<b>Pop-up Description</b>	Contains check boxes that let you choose formats for displaying pop-up SFR descriptions.
<b>Display Bit Layout</b>	If this box is checked the SFR bits will be displayed in the pop-up layout descriptions.
<b>Display Bit Descriptions</b>	Checking this box enables displaying the pop-up descriptions for the SFR bits, if any.
<b>Auto-size Name Field</b>	When this box is checked and when the vertical grid is visible (see note below), the window automatically adjusts the <b>Name</b> column width to fit the longest record in the column.
<b>Tabs</b>	Lists all the tabs present in the window.



<b>Add Tab</b>	Opens the <b>Add New Tab to Watches Window</b> dialog for entering a new tab's name. The window adds this new tab upon pressing <b>OK</b> .
<b>Remove Tab</b>	Removes the tab selected in the <b>Tabs</b> list.
<b>Edit Tab Name</b>	Opens the <b>Edit Watch Window Tab Name</b> dialog for editing the tab name.
<b>Global Debug/ Display Options</b>	Opens the <b>Debug Options</b> dialog.

**Note.** To make grids visible in the **Watches** window open the [Configure](#) menu, the **Environment** dialog, the [Fonts tab and check corresponding boxes in](#) the **Grid** field.

#### 4.5.3.2.2 The Add Watch Dialog

Use this dialog box to add symbol names (for example, a variable name or an [expression](#)) to the **Watches** window. The dialog contains a list of the symbol names defined in or known to the program.

Element of dialog	Description
<b>Name or expression to watch:</b>	Enter into this box the symbol name or expression to be added. You can specify several names and expressions either manually (separated with semicolons) or by selecting in the list with the <b>Ctrl</b> key pressed.
<b>History</b>	The list of previous names and expressions.

#### 4.5.3.3 The User Window

The **User** window is a window that can be created by means of the built-in **OpenUserWindow** function executed from the script itself. The **User windows** enable:

- drawing graphical objects (indicators, LEDs, buttons, arrows, etc. by means of the built-in graphical output functions;
- displaying texts in the window;
- responding to the events displaying in the **User windows** (see **WaitWindowEvent**).

With this capability, you can organize window operations in the interactive mode. For more information, see [Script Files](#).

All functions working with windows (including the **User** window) obtain the window identifier (handle) as a parameter. Therefore, you can have several windows of this type opened at the same time.

The **User** windows do not have a local menu. They only have toolbars with 16 buttons (**0...F**), and each button can be programmed to perform a certain function. Pressing a button generates the **WE\_TOOLBARBUTTON** event.

#### 4.5.3.4 The I/O Stream Window

The **I/O Stream window** is a window that can be created by means of the built-in **OpenUserWindow** function executed from the script itself. Script files use windows of this type to display I/O streams in the form of text. The most usual examples of I/O streams are displaying the characters inputted from the PC keyboard and text messages outputting by the scripts. Also, you can reassign I/O streams to files and input data from files.

The functions, which operate with windows (including the **I/O Stream** window), receive the window identifier (handle) as a parameter. Therefore, several windows of this type can be open at the same time.

When the text display function sends text to this window, the window displays the text from the current cursor position. To begin the next line, this function outputs '\n' (the line feed character).

The window features two text display modes: with the automatic line advance (Wrap) and without it. In the automatic line feed mode, every text line that does not fit in the window is wrapped to the next line. In the other mode, if the line does not fit in the window, its end will lie beyond the window border and will be invisible. The **Wrap** button in the toolbar toggles the window between these modes. The **Clear** button clears the window contents.

Windows of this type do not have a local menu.

## 4.6 Programming Automation via DLL

Any ChipProg programmer can be controlled not only from the ChipProgUSB [user interface](#) but also from an external computerized environment, which is appropriate for programming automation. This chapter describes how to integrate a ChipProg programmer into an external environment by means of Phyton's proprietary [Application Control Interface](#) (hereafter **ACI**). Remember that use of the Application Control Interface requires the ChipProg to be driven from a PC under Windows XP, 7 or 8.

### 4.6.1 Application Control Interface

#### What is the Application Control Interface?

The **ACI** is a set of proprietary Phyton software elements that allows integration of the ChipProg programmers into an external computerized environment, for example Automated Test Equipment (ATE). The ChipProgUSB software includes three Application Control Interface components:

- 1) The **ACI.DLL** file that specifies a set of [ACI functions](#), which can be invoked from external applications to perform programming operations. This DLL conforms completely to Microsoft's dynamically-linked shared library concept.
- 2) The **aciprogram.h** header file written in the C/C++ language that lists all the [ACI functions](#) exported to the ACI.DLL.DLL and the structures associated with these functions.
- 3) A few program examples that control ChipProg programmers from external applications

#### Requirements

- 1) The ChipProgUSB software must be installed on the computer that controls the ChipProg operations (hereafter the instrumental or host computer). The latest ChipProgUSB software version is available for free download from the <http://www.phyton.com/htdocs/support/update.shtml> webpage.
- 2) The **ACI.DLL.DLL** requires the Windows XP, Windows 7, or Windows 8 operating system.
- 3) It is necessary to position the **windows.h** file **before** the **aciprogram.h** file in the application program.

#### 32- and 64-bit Microsoft Windows OS - specific of use

There is the difference in Application Control Interface use under control of the 32- and 64-bit Windows. 32-bit applications should use the ACI.DLL dll and the ACI.lib export library; 64-bit - ACI64.DLL and ACI64.lib respectfully. 32-bit applications can be used for working with Application Control Interface under control of either Windows versions: 32- and 64-bit.

#### How does the Application Control Interface works?

The ACI.DLL launches the programmer's executable file by means of the [ACI\\_Launch\(\)](#) function and then controls the ChipProgUSB software by calling other ACI functions. The ChipProgUSB executable, universal for all Phyton USB-hosted programmers, is **UProgNT2.exe**.

Each ACI function, being called by an external application, sends back to this application a unique function return code. The return code constants - **ACI\_ERR\_XXX** - are defined into the aciprogram.h file included in the ACI software set.

The ACI.DLL launches the programmer executable file by means of the [ACI\\_Launch\(\)](#) function and then controls the ChipProgUSB software by calling other ACI functions. The ChipProg executable, universal for all USB-hosted programmers, is the **UProgNT2.exe**.

Each ACI function, being called by an external application, sends back to this application a function return code. The return code constants - **ACI\_ERR\_xxx** - are defined into the aciprogram.h file included into the ACI software set.

An external application can call either an ACI function without any parameter (just by the function name) or by the function name with an added pointer to the parameter structure. The very first member of any structure is always the 'UINT size' parameter that defines the structure size. This insures compatibility of different ACI.DLL versions. The only exception is the **ACI\_IDECommand()** function. Here we sacrificed uniformity of the structure format in behalf of simplicity of the pseudo-function declaration.

Names of all the ACI objects (functions and structures) always begin with the prefix **ACI**. Names of the structure patterns complete with the suffix **\_Params**.

Numbers of the memory buffers and layers in memory buffers begin from zero. All addresses have a 64-bit format and consist of two 32-bit halves (low and high), in order to be compiler-independent. For example, if the compiler recognizes the **uint64** type of data, then the function call for the function that assigns a 64-bit memory buffer address in the structure **ACI\_Memory\_Params**, can be presented as:

```
ACI_Memory_Params params;  
*((uint64 *)params.AddressLow) = 0x123456789ABC;
```

**Note!** All addresses in the structures are shown in the format specified by the device manufacturer, i.e. in Bytes, Words, etc. For example, for any 16-bit microcontroller the address format is always a Word, not a Byte.

In most cases, in a process in which the programming is under control of an external application, it is not necessary to make visible the ChipProgUSB graphical user interface (GUI). The ACI allows you to hide the ChipProgUSB GUI. However, it may be necessary to unhide the programmer GUI, or just some windows and dialogs, for setting up the programming environment and for debugging purposes (for example, for selecting the target device, loading the file, etc.). When the programming environment is set up, the ChipProgUSB user interface can be hidden to free more display space for the controlling application.

### **How to control multiple device programmers by means of the Application Control Interface?**

It is possible to remotely launch an unlimited number of ChipProg programmers and to drive each of them individually via ACI. After launching a programmer, the ACI creates in the ACI.DLL a special unique object - "**a connection**". A particular connection is defined by the [ConnectionID](#) parameter that defines a particular device programmer running under ACI control. The [ACI\\_SetConnection](#) function allows for selection of a particular device programmer among others. Then, after the programmer is selected, all the ACI functions will serve only one of these connections; i.e. they all will affect one selected device programmer. If only one programmer is under control, the connection will be set automatically.

It is important to remember that more than one ChipProgUSB can be launched in either the **Single-programming** or the [Multi-programming or Gang-programming](#) mode. If, for example, a cluster of six ChipProg programmers was launched in the gang mode, then a whole cluster driven by the ACI will represent a single connection, not six connections. So, in terms of the ACI, this cluster will have one **ConnectionID**.

---

for example Automated Test Equipment (ATE)

## 4.6.2 ACI Functions

In order to set up and control a ChipProg tool, the program running on the instrumental computer calls the Application Control Interface functions listed in the matrix below. Most of these functions are grouped in "bidirectional couples" (In-Out or Get-Set). Calling some Application Control Interface functions requires structures that specify memory locations, pointers and other objects affiliated with the called function, while other functions do not require any structures. Here is the list of the ChipProg Application Control Interface functions:

Application Control Interface function name	Brief description	Associated windows and dialogs	Associated Application Control Interface structures
<b>1. ACI functions that start and stop programming sessions</b>			
<a href="#">ACI_Launch</a>	Starts the ChipProgUSB program. This function must always be the very first in the chain of other Application Control Interface functions that form the programming session.	NA	<a href="#">ACI_Launch_Params</a>
<a href="#">ACI_Exit</a>	Closes the ChipProgUSB program. This function must always be the last one in the chain of other Application Control Interface functions. It completes the external control session.	NA	NA
<b>2. ACI functions that configure the programmer or get its current configuration</b>			
<a href="#">ACI_LoadConfigFile</a>	Loads the programmer configuration parameters from the host computer to the programmer.	NA	<a href="#">ACI_Config_Params</a>
<a href="#">ACI_SaveConfigFile</a>	Saves the programmer's current configuration parameters to the host computer.	NA	<a href="#">ACI_Config_Params</a>
<b>3. ACI functions that get the target device properties or set them</b>			
<a href="#">ACI_GetDevice</a>	Gets the manufacturer's name (brand) and the part number of the device currently being programmed from the programmer to the host computer.	<a href="#">Select Device</a>	<a href="#">ACI_Device_Params</a>
<a href="#">ACI_SetDevice</a>	Sets the manufacturer's name and the part number of the device to be programmed in the programmer.	<a href="#">Select Device</a>	<a href="#">ACI_Device_Params</a>
<b>4. ACI functions that get current parameters of the buffers and layers or configure them</b>			
<a href="#">ACI_GetLayer</a>	Gets the parameters of a specified memory buffer and layer from the programmer to the host computer.	<a href="#">Buffer Dump</a>	<a href="#">ACI_Layer_Params</a>
<a href="#">ACI_CreateBuffer</a>	Creates a memory buffer with specified parameters in the programmer.	<a href="#">Buffer Dump</a>	<a href="#">ACI_Buffer_Params</a>
<a href="#">ACI_ReallocBuffer</a>	Changes a size of the layer #0 in a specified memory buffer in the programmer.	<a href="#">Buffer Dump</a>	<a href="#">ACI_Buffer_Params</a>
<b>5. ACI functions that read the content of the buffer layer or write into it</b>			
<a href="#">ACI_ReadLayer</a>	Reads data from a specified memory buffer in the programmer to the host computer.	<a href="#">Buffer Dump</a>	<a href="#">ACI_Memory_Params</a>
<a href="#">ACI_WriteLayer</a>	Writes data into a specified memory buffer of	<a href="#">Buffer Dump</a>	<a href="#">ACI_Memory_Params</a>

Application Control Interface function name	Brief description	Associated windows and dialogs	Associated Application Control Interface structures
	the host computer to the programmer memory buffer.		
<a href="#">ACI_FillLayer</a>	Fills a whole selected layer of a specified memory buffer with a specified data pattern.	<a href="#">Buffer Dump</a>	<a href="#">ACI_Memory_Params</a>
<b>6. ACI functions that get programming parameters from the programmer or set them in the programmer</b>			
<a href="#">ACI_GetProgrammingParams</a>	Gets current programming parameters from the programmer to the host computer.	Program Manager > <a href="#">Options</a>	<a href="#">ACI_Programming_Params</a>
<a href="#">ACI_SetProgrammingParams</a>	Sets programming parameters from the host computer to the programmer.	Program Manager > <a href="#">Options</a>	<a href="#">ACI_Programming_Params</a>
<b>7. ACI functions that get device-specific programming options from the programmer or set them in the programmer</b>			
<a href="#">ACI_GetProgOption</a>	Gets current programming options from the programmer to the host computer.	<a href="#">Device and Algorithm Parameters</a>	<a href="#">ACI_ProgOption_Params</a>
<a href="#">ACI_SetProgOption</a>	Sets programming options from the host computer to the programmer.	<a href="#">Device and Algorithm Parameters</a>	<a href="#">ACI_ProgOption_Params</a>
<a href="#">ACI_AllProgOptionsDefault</a>	Sets default programming options and programming algorithms in the programmer.	<a href="#">Device and Algorithm Parameters</a>	<a href="#">ACI_ProgOption_Params</a>
<b>8. ACI functions that control programming operations</b>			
<a href="#">ACI_ExecFunction</a>	Initiates a specified programming operation, keeping under control its successful completion or failure. It controls a single programmer.	<a href="#">Program Manager</a>	<a href="#">ACI_Function_Params</a>
<a href="#">ACI_StartFunction</a>	Initiates a specified programming operation and then does not check the operation result. It controls a single programmer.	<a href="#">Program Manager</a>	<a href="#">ACI_Function_Params</a>
<a href="#">ACI_GangStart</a>	Used to control multiple device programmers. Initiates auto programming in the gang ( <a href="#">multi-programming</a> ) mode.	<a href="#">Program Manager</a>	<a href="#">ACI_GangStart_Params</a>
<a href="#">ACI_GetStatus</a>	Gets a current programmer status information.	<a href="#">Program Manager</a>	<a href="#">ACI_PStatus_Params</a>
<a href="#">ACI_TerminateFunction</a>	Terminates a current programming operation.	<a href="#">Program Manager</a>	NA
<a href="#">ACI_GangTerminateFunction</a>	Terminates a current programming operation	<a href="#">Program</a>	<a href="#">ACI_GangTerminate_Para</a>

Application Control Interface function name	Brief description	Associated windows and dialogs	Associated Application Control Interface structures
	on a specified site of the gang programmer.	<a href="#">Manager</a>	<a href="#">ms</a>
<b>9. ACI functions that save files from the programmer and load files to the programmer</b>			
<a href="#">ACI_FileSave</a>	Saves a specified file from a specified buffer's layer of the programmer into the instrumental computer.	<a href="#">Buffer Dump</a>	<a href="#">ACI_File_Params</a>
<a href="#">ACI_FileLoad</a>	Loads a specified file from the instrumental computer to a specified buffer's layer in the programmer.	<a href="#">Buffer Dump</a>	<a href="#">ACI_File_Params</a>
<b>10. ACI functions that display programmer's windows and dialogs for setting up and debugging external programming sessions</b>			
<a href="#">ACI_SettingsDialog</a>	Displays the programmer Preferences dialog.	Configure > <a href="#">Preferences</a>	NA
<a href="#">ACI_SelectDeviceDialog</a>	Displays the Select Device dialog.	<a href="#">Select Device</a>	NA
<a href="#">ACI_BuffersDialog</a>	Displays the memory buffers setting dialog.	<a href="#">Buffer Dump</a>	NA
<a href="#">ACI_LoadFileDialog</a>	Displays the file loading dialog.	<a href="#">Buffer Dump</a>	NA
<a href="#">ACI_SaveFileDialog</a>	Displays the file saving dialog.	<a href="#">Buffer Dump</a>	NA

#### 4.6.2.1 ACI\_Launch

```
ACI_FUNC ACI_Launch(ACI\_Launch\_Params * params);
```

##### Description

This function launches the ChipProgUSB software. Optionally this ACI function can launch the programmer with a specified [command line key](#) and load the file that will [configure](#) the ChipProg hardware.

**Note! This ACI function must always be called before any other ACI function !**

#### 4.6.2.2 ACI\_Exit

```
ACI_FUNC ACI_Exit();
```

##### Description

Call of this function stops the ChipProgUSB software. In most cases the programmer practically immediately stops running. Sometimes, after calling the **ACI\_Exit** function, it continues working for a while to correctly complete an earlier launched process. After all, the ChipProg will stop and quit itself after finding that the controlling process has ended.

It is possible, however, that the ChipProgUSB software will keep running even after the control process



has completely stopped. This is an abnormal situation and, as a result, it will be impossible to re-establish communication with the programmer hardware by launching the [ACI\\_Launch](#) function. In this case you should manually close the ChipProgUSB program via the Windows Task Manager.

#### 4.6.2.3 ACI\_LoadConfigFile

```
ACI_FUNC ACI_LoadConfigFile(ACI\_Config\_Params * params);
```

##### Description

This function loads the ChipProg configuration parameters that include all the settings available via the ChipProgUSB dialogs (memory buffer configurations, programming options, test of the device insertion, etc.).

The ChipProgUSB program automatically saves some programming options and settings, including the type of selected device, the device parameters, the start and end addresses of the device being programmed, the buffer start address, and a set of the [Auto Programming](#) commands. Then it automatically restores these parameters when the user changes the device type.

See also: [ACI\\_SetProgrammingParams](#), [ACI\\_SetProgOption](#), [ACI\\_GetProgrammingParams](#), [ACI\\_GetProgOption](#), [ACI\\_SaveConfigFile](#)

#### 4.6.2.4 ACI\_SaveConfigFile

```
ACI_FUNC ACI_SaveConfigFile(ACI\_Config\_Params * params);
```

##### Description

This function saves the ChipProg options specified in the tab [Option](#) of the [Program Manager](#) window (memory buffer configurations, programming options, test of the device insertion, etc.).

The ChipProgUSB program automatically saves some programming options and settings including a type of the selected device, the device parameters, the start and end addresses of the device being programmed, the buffer start address, and a set of the [Auto Programming](#) commands and then automatically restores these parameters when the user changes the device type.

См. также: [ACI\\_SetProgrammingParams](#), [ACI\\_SetProgOption](#), [ACI\\_GetProgrammingParams](#), [ACI\\_GetProgOption](#), [ACI\\_LoadConfigFile](#)

#### 4.6.2.5 ACI\_SetDevice

```
ACI_FUNC ACI_SetDevice(ACI\_Device\_Params * params);
```

**Description**

This function chooses the device to be programmed. Along with the device type, the function automatically loads the device parameters, start and end addresses and the buffer start address. Also, it restores the [Auto Programming](#) command list if the selected device type has ever been selected earlier, but the parameters listed above were changed during the programming session.

**4.6.2.6 ACI\_GetDevice**

```
ACI_FUNC ACI_GetDevice(ACI\_Device\_Params * params);
```

**Description**

This function gets the device's part number (name) and the name of the manufacturer of the device being programmed now (for example: AT89C51, Atmel; 28F128J3C, Numonyx, etc.).

**4.6.2.7 ACI\_GetLayer**

```
ACI_FUNC ACI_GetLayer(ACI\_Layer\_Params * params);
```

**Description**

This function gets the parameters of a specified memory buffer and buffer's layer.

See also the [ACI\\_Layer\\_Params](#) structure description.

**4.6.2.8 ACI\_CreateBuffer**

```
ACI_FUNC ACI_CreateBuffer(ACI\_Buffer\_Params * params);
```

**Description**

This function creates a buffer with the parameters specified by the [ACI\\_Buffer\\_Params](#) structure. The ChipProgUSB program automatically assigns the buffer #0 so it is not necessary to create this buffer by a separate command.

See also the [ACI\\_Buffer\\_Params](#) structure description.

**4.6.2.9 ACI\_ReallocBuffer**

```
ACI_FUNC ACI_ReallocBuffer(ACI\_Buffer\_Params * params);
```

**Description**

This function changes the size of the layer #0 in the memory buffer specified in the [ACI\\_Buffer\\_Params](#) structure.

See also the [ACI\\_Buffer\\_Params](#) structure description.

#### 4.6.2.10 ACI\_ReadLayer

```
ACI_FUNC ACI_ReadLayer(ACI\_Memory\_Params * params);
```

##### Description

This function reads data from a specified memory buffer. The data size is limited by 16M Bytes.

**Note!** This function reads the data from the programmer's memory buffer but **does not physically read out the content of the selected target device**. In order to physically read out the device memory content, execute the programmer command (function) **Read** by means of the [ACI\\_ExecFunction](#) or [ACI\\_StartFunction](#) with appropriate attributes.

#### 4.6.2.11 ACI\_WriteLayer

```
ACI_FUNC ACI_WriteLayer(ACI\_Memory\_Params * params);
```

##### Description

This function writes data to a specified memory buffer. The data size is limited by 16M Bytes.

**Note!** This function writes the data to the programmer's memory buffer but **does not physically program the device**. In order to physically write data from the buffer to the device's memory, execute the programmer command (function) **Program** by means of the [ACI\\_ExecFunction](#) or [ACI\\_StartFunction](#) with appropriate attributes.

#### 4.6.2.12 ACI\_FillLayer

```
ACI_FUNC ACI_FillLayer(ACI\_Memory\_Params * params);
```

##### Description

This function fills a whole active layer of a specified memory buffer with a specified data pattern. This function works much faster than the [ACI\\_WriteLayer](#) function which writes data to the buffer layer.

**Note!** This function fills the programmer's memory buffer with a specified data pattern but **does not physically write them to the device being programmed**. In order to physically write data from the buffer to the device execute the programmer command (function) **Program** by means of the [ACI\\_ExecFunction](#) or [ACI\\_StartFunction](#) with appropriate attributes.

#### 4.6.2.13 ACI\_GetProgrammingParams

```
ACI_FUNC ACI_GetProgrammingParams(ACI\_Programming\_Params * params);
```

##### Description

This function gets current programming parameters specified in the tab [Option](#) of the [Program Manager](#) window (memory buffer configurations, programming options, test of the device insertion, etc.).

See the [ACI\\_Programming\\_Params](#) structure description.

#### 4.6.2.14 ACI\_SetProgrammingParams

```
ACI_FUNC ACI_SetProgrammingParams(ACI\_Programming\_Params * params);
```

##### Description

This function sets programming parameters specified in the tab [Option](#) of the [Program Manager](#) window (memory buffer configurations, programming options, test of the device insertion, etc.).

See also the [ACI\\_Programming\\_Params](#) structure description.

#### 4.6.2.15 ACI\_GetProgOption

```
ACI_FUNC ACI_GetProgOption(ACI\_ProgOption\_Params * params);
```

##### Description

This function gets current settings from the [Device and Algorithm Parameters Editor](#) window. As an example see this window for one of the microcontrollers below.

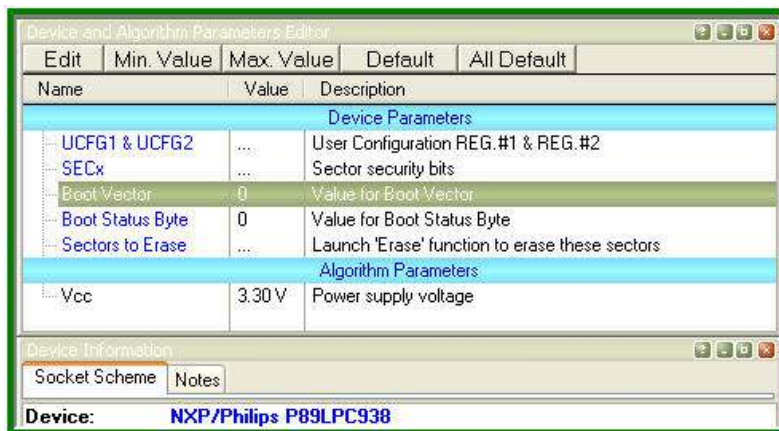

**Note!** This function **does not physically read the specified information from the device being programmed**. It reads from some virtual memory locations in the host PC's RAM, associated with physical locations in the target device's memory and registers. If the option that you would like to check is a property of the device's memory or registers, then first you have to execute the programmer

command (function) **Read** in the command group **Device Parameters** by means of the [ACI ExecFunction](#) or [ACI StartFunction](#) with appropriate attributes. Then you can read the execute the [ACI\\_GetProgOption](#) function.

See also the [ACI ProgOption Params](#) structure description.

#### 4.6.2.16 ACI\_SetProgOption

```
ACI_FUNC ACI_SetProgOption(ACI\_ProgOption\_Params * params);
```

##### Description

This function sets device-specific options and parameters, which are specified in the [Device and Algorithm Parameters Editor](#) window. As an example see this window for one of the microcontrollers below.

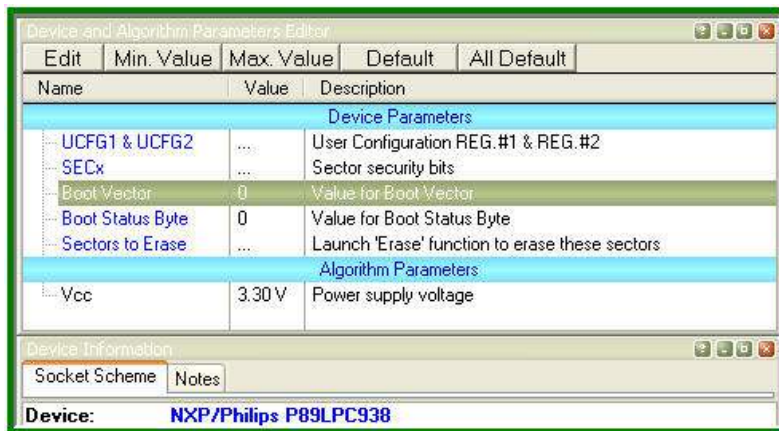

**Note!** This function **does not physically write the specified information into the device being programmed**. It actually writes to some virtual memory locations in the host PC's RAM, associated with physical locations in the target device's memory and registers. In order to complete programming the device parameters and to physically program them into the device's memory you should execute an appropriate **Program** command (function) in the command group **Device Parameters**, by means of the [ACI ExecFunction](#) or [ACI StartFunction](#) with appropriate attributes.

See also the [ACI\\_ProgOption\\_Params](#) structure description.

#### 4.6.2.17 ACI\_AllProgOptionsDefault

```
ACI_FUNC ACI_AllProgOptionsDefault ();
```

##### Description

This function sets default device-specific options and parameters specified in the [Device and Algorithm Parameters Editor](#) window. These default parameter sets vary. They are defined by the device manufacturers in the device data sheets.

**Note!** This function **does not physically restore the default settings into the device being programmed**. It actually writes to some virtual memory locations in the host PC's RAM, associated with physical locations in the target device's memory and registers. In order to complete programming the device parameters and to physically fix them in the device's memory you should execute an appropriate **Program** command (function) in the **Device Parameters** command group by means of the [ACI\\_ExecFunction](#) or [ACI\\_StartFunction](#) with appropriate attributes.

#### 4.6.2.18 ACI\_ExecFunction

```
ACI_FUNC ACI_ExecFunction(ACI\_Function\_Params * params);
```

##### Description

This function launches one of the programming operation (**Read**, **Erase**, **Verify**, etc.) specified by the [ACI\\_Function\\_Params](#). During execution the **ACI\_ExecFunction** does not allow calling any other ACI function until the programming operation, initiated by the **ACI\_ExecFunction** function, completes the job. The [ACI\\_ExecFunction](#) from the [ACI\\_StartFunction](#) that returns control immediately after it was called.

#### 4.6.2.19 ACI\_StartFunction

```
ACI_FUNC ACI_StartFunction(ACI\_Function\_Params * params);
```

##### Description

This function launches one of the programming operation (**Read**, **Erase**, **Verify**, etc.) specified by the [ACI\\_Function\\_Params](#) and immediately returns control to the external application no matter whether the programming operation, initiated by the **ACI\_StartFunction**, has or has not completed. The [ACI\\_StartFunction](#) is different from the [ACI\\_ExecFunction](#). It is possible to check if the operation has completed by the [ACI\\_GetStatus](#) function call. This allows monitoring the execution of programming operations if they last for a long time.

#### 4.6.2.20 ACI\_GangStart

```
ACI_FUNC ACI_GangStart(ACI_GangStart_Params * params);
```

##### Description

This function is used to control [multiple device programmers](#) only when the ChipProgUSB program was launched from the command line with the **/gang** key to drive a ChipProg gang programmer or a cluster of multiple programmers connected to one PC! See also the [ACI\\_Launch](#) function. For controlling a single ChipProg device programmer use [ACI\\_StartFunction](#) or [ACI\\_ExecFunction](#).

The **ACI\_GangStart** function launches [Auto Programming](#) on multiple ChipProg device programmers for the programming socket specified in the **SiteNumber** parameter of the [ACI\\_PStatus\\_Params](#) structure. The function returns control immediately. In order to detect the ending time of the **ACI\_GangStart** execution, use the [ACI\\_GetStatus](#) function.

#### 4.6.2.21 ACI\_GetStatus

```
ACI_FUNC ACI_GetStatus(ACI_PStatus_Params * params);
```

##### Description

This function gets the programmer status that includes:

- 1) The status of the programming operation initiated by the [ACI\\_StartFunction](#) call (whether it has completed or it is still in progress);
- 2) The device insertion status (certainly if this option is enabled in the tab [Option](#) of the [Program Manager](#) window).

#### 4.6.2.22 ACI\_TerminateFunction

```
ACI_FUNC ACI_TerminateFunction();
```

##### Description

This function terminates a current programming operation initiated by the [ACI\\_StartFunction](#) call.

#### 4.6.2.23 ACI\_GangTerminateFunction

```
ACI_FUNC ACI_GangTerminateFunction(ACI_GangTerminate_Params * params);
```

##### Description

This function, similar to the [ACI\\_TerminateFunction](#) which is applicable for stopping a single device programmer, is intended for terminating a current programming operation on one programming site belonging to the multiprogramming cluster or a gang programmer. The programming site (or socket)

number is specified by the **SiteNumber** parameter from the **ACI\_GangTerminate\_Params** structure.

This function can be used **only** for the ChipProg programmers launched in the [gang mode](#) (see the / **gang** parameter among other [command line keys](#) for the [ACI\\_Launch](#) function). In order to terminate an operation for a running single-site ChipProg programmer use the [ACI\\_TerminateFunction](#).

When the [ACI\\_GangTerminateFunction](#) initiates stopping a current operation it returns the control either when the operation was successfully stopped or with a delay defined by the **Timeout** parameter.

#### 4.6.2.24 ACI\_FileLoad

```
ACI_FUNC ACI_FileLoad(ACI\_File\_Params * params);
```

##### Description

This function loads a specified file into a specified buffer's layer. The control program running on the host PC should not worry about the file's format settings - the ChipProgUSB software takes care of this.

#### 4.6.2.25 ACI\_FileSave

```
ACI_FUNC ACI_FileSave(ACI\_File\_Params * params);
```

##### Description

This function saves a specified file from a specified buffer's layer. The ChipProgUSB software enables [saving files](#) in all popular formats: HEX, Binary, etc..

#### 4.6.2.26 ACI\_SettingsDialog

```
ACI_SettingsDialog();
```

##### Description

This macro opens the [Configure > Preferences](#) setting dialog. The dialog will be visible irrespective of the ChipProgUSB main window status; the main window can remain closed but the [Configure > Preferences](#) setting dialog will appear on the computer screen, thus allowing manipulations in the dialog.

#### 4.6.2.27 ACI\_SelectDeviceDialog

```
ACI_SelectDeviceDialog();
```

##### Description

This macro sends a command that opens the [Select Device](#) dialog. The dialog will appear on the screen irrespective of the ChipProgUSB main window status; the main window can remain closed but the [Select Device](#) dialog will appear on the computer screen.



#### 4.6.2.28 ACI\_BuffersDialog

[ACI\\_BuffersDialog\(\)](#);

##### Description

This macro opens the [Memory Dump Window Setup](#) dialog. The dialog will be visible irrespective of the ChipProgUSB main window status; the main window can remain closed but the [Memory Dump Window Setup](#) dialog will appear on the computer screen to allow the buffer setup. See the dialog example below.

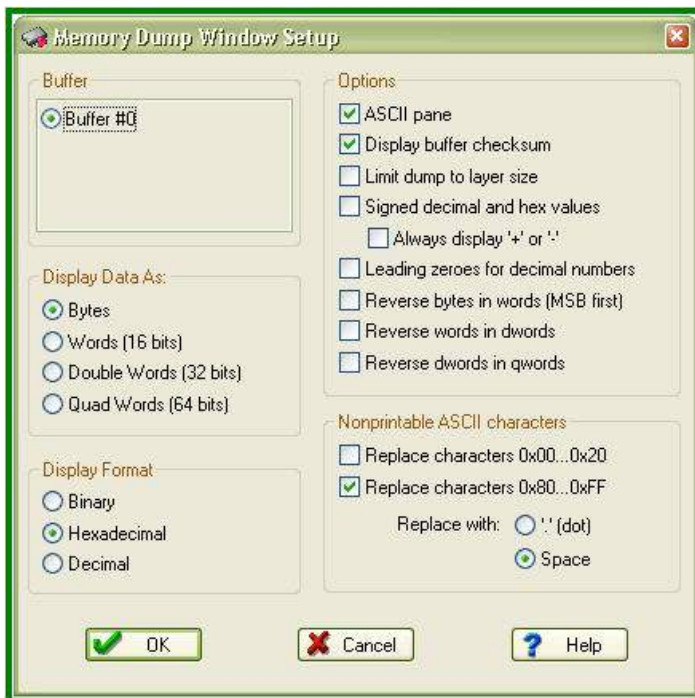

#### 4.6.2.29 ACI\_LoadFileDialog

[ACI\\_LoadFileDialog\(\)](#);

##### Description

This macro opens the [Load File](#) dialog. The dialog will be visible irrespective of the ChipProgUSB main window status; the main window can remain closed but the [Load File](#) dialog will appear on the computer screen. See the dialog example below.

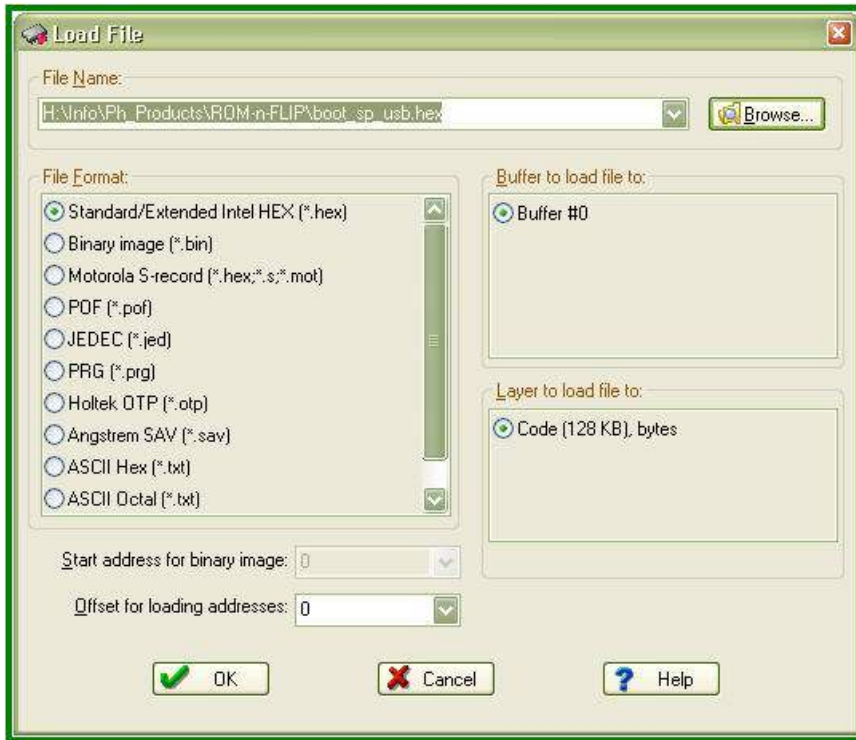

#### 4.6.2.30 ACI\_SaveFileDialog

[ACI\\_SaveFileDialog\(\)](#);

##### Description

This macro sends a command that opens the [Save File](#) dialog. The dialog will be visible irrespective of the ChipProgUSB main window status; the main window can remain closed but the [Save File](#) dialog will appear on the computer screen. See the dialog example below.



#### 4.6.2.31 ACI\_SetConnection

ACI\_FUNC ACI\_SetConnection([ACI\\_Connection\\_Params](#) \* params);

##### Description

This function identifies a current device programmer connection. Use this function when you control a number of device programmers by means of multiple calls of the [ACI\\_Launch](#) function. Each connection gets its own unique identifier. Executing of the [ACI\\_Launch](#) function returns the [ConnectionId](#) as part of the [ACI\\_Launch\\_Params](#) structure.

After establishing the connection, all the ACI functions following the [ACI\\_SetConnection](#) function will work exclusively with the established connection.

When ACI controls only one ChipProg programmer it is not necessary to execute the [ACI\\_SetConnection](#) function; the [ACI\\_Launch](#) function automatically assigns a [ConnectionId](#) that is the next one in order.

The [ConnectionId](#) can be always checked by executing the function [ACI\\_GetConnection](#).

#### 4.6.2.32 ACI\_GetConnection

ACI\_FUNC ACI\_GetConnection([ACI\\_Connection\\_Params](#) \* params);

##### Description

This function allows getting the identifier of a current device programmer connection. If a number of single ChipProg programmers were launched, one after another, by multiple executions of the

[ACI\\_Launch](#) function, then executing the [ACI\\_GetConnection](#) function returns a current [ConnectionId](#) parameter as a part of the [ACI\\_Launch\\_Params](#) structure.

See also [ACI\\_SetConnection](#).

### 4.6.3 ACI Structures

This chapter describes the structures used by the [ACI functions](#).

Structure	The ACI function that uses the structure
<a href="#">ACI_Launch_Params</a>	<a href="#">ACI_Launch</a>
<a href="#">ACI Config_Params</a>	<a href="#">ACI_LoadConfigFile</a> , <a href="#">ACI_SaveConfigFile</a>
<a href="#">ACI_Device_Params</a>	<a href="#">ACI_GetDevice</a> , <a href="#">ACI_SetDevice</a> ,
<a href="#">ACI_Layer_Params</a>	<a href="#">ACI_GetLayer</a>
<a href="#">ACI_Buffer_Params</a>	<a href="#">ACI_CreateBuffer</a> , <a href="#">ACI_ReallocBuffer</a>
<a href="#">ACI_Memory_Params</a>	<a href="#">ACI_ReadLayer</a> , <a href="#">ACI_WriteLayer</a> , <a href="#">ACI_FillLayer</a>
<a href="#">ACI_Programming_Params</a>	<a href="#">ACI_SetProgrammingParams</a> , <a href="#">ACI_GetProgrammingParams</a>
<a href="#">ACI_ProgOption_Params</a>	<a href="#">ACI_GetProgOption</a> , <a href="#">ACI_SetProgOption</a>
<a href="#">ACI_Function_Params</a>	<a href="#">ACI_ExecFunction</a> , <a href="#">ACI_StartFunction</a>
<a href="#">ACI_PStatus_Params</a>	<a href="#">ACI_GetStatus</a>
<a href="#">ACI_File_Params</a>	<a href="#">ACI_FileLoad</a> , <a href="#">ACI_FileSave</a>
<a href="#">ACI_GangStart_Params</a>	<a href="#">ACI_GangStart</a> , <a href="#">ACI_GetStatus</a>
<a href="#">ACI_GangTerminate_Params</a>	<a href="#">ACI_GangTerminateFunction</a>

Here is an example of the structure syntax:

```
typedef struct tagACI_Buffer_Params
{
    UINT    Size;                // (in)    Size of structure, in bytes
    DWORD   Layer0SizeLow;      // (in || out) Low 32 bits of layer 0 size, in bytes
    DWORD   Layer0SizeHigh;     // (in || out) High 32 bits of layer 0 size, in bytes
                                //          Layer size is rounded up to a nearest value
supported by programmer.
    LPCSTR  BufferName;         // (in)    Buffer name
    UINT    BufferNumber;       // For ACI_CreateBuffer(): out: Created buffer number
                                // For ACI_ReallocBuffer(): in: Buffer number to realloc
    UINT    NumBuffers;        // (out)   Total number of currently allocated buffers
    UINT    NumLayers;         // (out)   Total number of layers in a buffer
} ACI_Buffer_Params;
```

Each structure includes a number of parameters (here Size, Layer0SizeLow, NumBuffers, etc.). The parameter's name follows its format (UINT, DWORD, LPCSTR, CHAR, BOOL, etc.). The comment on the parameter begins from a bracketed symbol showing the sending direction of this parameter:

- **(in)** - the parameter is sent from the instrumental computer **to** the programmer;
- **(out)** - the parameter is sent **from** the programmer to the instrumental computer;
- **(in || out)** - the parameter can be sent in **either direction**, depending on the ACI function context.

#### 4.6.3.1 ACI\_Launch\_Params

```
typedef struct tagACI_Launch_Params
{
    UINT    Size;           // (in)  Size of structure, in bytes
    LPCSTR  ProgrammerExe; // (in)  Programmer executable file name
    LPCSTR  CommandLine;   // (in)  Optional programmer command-line parameters
    BOOL    DebugMode;     // (in)  Debug mode. Programmer window is not hidden
} ACI_Launch_Params;
```

<b>ProgrammerExe</b>	<p>This is the name of the programmer executable file. If the parameter does not include a full path then the program will search for the UprogNT2.EXE file into the folder where the ACI.DLL resides.</p> <p>The target folder name, where the the UprogNT2.EXE file resides, is defined by the parameter "Folder" of the ""HKLM\SOFTWARE\Phyton\Phyton ChipProgUSB Programmer\x.yy.zz" key. It is supposed that multiple ChipProgUSB versions can be installed on the host computer.</p>
<b>CommandLine</b>	<p>This structure member specifies the <a href="#">command line options</a>. One of the option is NULL (no keys). If the host computer drives a <a href="#">cluster</a> of multiple programmers then the only way to launch a certain programmer is to specify the <b>/N&lt;serial number&gt;</b> for the <b>CommandLine</b> structure member.</p>
<b>DebugMode</b>	<p>This key controls the ChipProgUSB main window visibility. Setting TRUE for this structure member makes the ChipProgUSB main window visible. Then you can manipulate with the programmer using its user interface - open windows, set any programmer resources, execute programming operations, etc..</p>

See also: [ACI\\_Launch](#)

#### 4.6.3.2 ACI\_Config\_Params

```
typedef struct tagACI_Config_Params
{
    UINT    Size;           // (in)  Size of structure, in bytes
    LPCSTR  FileName;      // (in)  Options file name to load/save configuration
} ACI_Config_Params;
```

<b>FileName</b>	This is the name of the file that configures the programmer.
-----------------	--

See also: [ACI\\_LoadConfigFile](#), [ACI\\_SaveConfigFile](#)

### 4.6.3.3 ACI\_Device\_Params

```
typedef struct tagACI_Device_Params
{
    UINT    Size;                // (in)        Size of structure, in bytes
    CHAR    Manufacturer[64];    // (in || out) Device Manufacturer
    CHAR    Name[64];           // (in || out) Device Name
} ACI_Device_Params;
```

Manufacturer	The manufacturer of the device being programmed
Name	The device part number as it is displayed in the programmer's device list

See also: [ACI\\_SetDevice](#), [ACI\\_GetDevice](#)

### 4.6.3.4 ACI\_Layer\_Params

```
typedef struct tagACI_Layer_Params
{
    UINT    Size;                // (in)        Size of structure, in bytes
    UINT    BufferNumber;        // (in)        Number of buffer of interest, the first
buffer number is 0
    UINT    LayerNumber;        // (in)        Number of layer of interest, the first layer
number is 0
    DWORD   LayerSizeLow;       // (out)       Low 32 bits of layer size, in bytes
    DWORD   LayerSizeHigh;      // (out)       High 32 bits of layer size, in bytes
    DWORD   DeviceStartAddrLow; // (out)       Low 32 bits of device start address for this
layer
    DWORD   DeviceStartAddrHigh; // (out)       High 32 bits of device start address for
this layer
    DWORD   DeviceEndAddrLow;   // (out)       Low 32 bits of device end address for this
layer
    DWORD   DeviceEndAddrHigh; // (out)       High 32 bits of device end address for this
layer
    DWORD   DeviceBufStartAddrLow; // (out)      Low 32 bits of device memory start address
in buffer for this layer
    DWORD   DeviceBufStartAddrHigh; // (out)      High 32 bits of device memory start address
in buffer for this layer
    UINT    UnitSize;           // (out)       Size of layer unit, in bits (8, 16 or 32)
    BOOL    FixedSize;          // (out)       Size of layer cannot be changed with
ACI_ReallocBuffer()
    CHAR    BufferName[64];      // (out)       Buffer name
    CHAR    LayerName[64];      // (out)       Layer name, cannot be changed
    UINT    NumBuffers;         // (out)       Total number of currently allocated buffers
    UINT    NumLayers;         // (out)       Total number of layers in a buffer
} ACI_Layer_Params;
```

<b>BufferNumber</b>	The ordinal number of the <a href="#">memory buffer</a> , content of which is required by the <a href="#">ACI_GetLayer</a> function. Numbers of ChipProg memory buffers begin from #0.
<b>LayerNumber</b>	The ordinal number of the layer in the <a href="#">memory buffer</a> , the content of which is required by the <a href="#">ACI_GetLayer</a> function. The layer numbers begins from #0.
<b>LayerSizeLow, LayerSizeHigh</b>	Here the function returns the range of the memory <a href="#">layer's</a> addresses in bytes.
<b>DeviceStartAddrLow, DeviceStartAddrHigh</b>	Here the function returns the device's start address for the selected <a href="#">memory layer</a> . This address is the device's property and strictly depends on the device type; usually this value is zero. Do not mix it up with the start address of a programming operation that can be shifted by a certain offset value.
<b>DeviceEndAddrLow, DeviceEndAddrHigh</b>	Here the function returns the device's end address for the selected memory layer. This address is the device's property and strictly depends on the device type. Do not mix it up with the end address of a programming operation editable in the setup dialog. The selected layer's address range can be defined as a difference between the end address and the start address plus 1.
<b>DeviceBufStartAddrLow, DeviceBufStartAddrHigh</b>	Here the function returns the start address for the selected <a href="#">memory buffer</a> - usually this value is zero.
<b>UnitSize</b>	This structure member specifies formats of the data in a <a href="#">memory layer</a> : 8 for the 8-bit devices, 16 - for 16-bit devices and 32 for 32-bit devices.
<b>FixedSize</b>	This flag, if TRUE, disables resizing the memory layer by the <a href="#">ACI_ReallocBuffer</a> function. There is one restriction on use of this flag: since the layer #0 is always resizeable the <b>FixedSize</b> is always FALSE for the layer #0.
<b>BufferName</b>	The name of the memory buffer as it was defined in the ChipProg interface or by the <a href="#">ACI_CreateBuffer</a> function call.
<b>LayerName</b>	Reserved name of the memory buffer's layer. It cannot be changed by the ACI.DLL user.
<b>NumBuffers</b>	The number of the assigned memory buffers.
<b>NumLayers</b>	The number of layers in the programmer's memory buffers. This is a pre-defined device-specific value that is the same for all memory buffers.

See also: [ACI\\_GetLayer](#)

#### 4.6.3.5 ACI\_Buffer\_Params

```
typedef struct tagACI_Buffer_Params
```

```

{
    UINT    Size;                // (in)  Size of structure, in bytes
    DWORD   Layer0SizeLow;      // (in/out) Low 32 bits of layer 0 size, in bytes
    DWORD   Layer0SizeHigh;    // (in/out) High 32 bits of layer 0 size, in bytes
                                //          Layer size is rounded up to a nearest value
supported by programmer.
    LPCSTR  BufferName;         // (in)  Buffer name
    UINT    BufferNumber;       // For ACI_CreateBuffer(): out: Created buffer number
                                // For ACI_ReallocBuffer(): in: Buffer number to realloc

    UINT    NumBuffers;        // (out) Total number of currently allocated buffers
    UINT    NumLayers;        // (out) Total number of layers in a buffer
} ACI_Buffer_Params;

```

<b>Layer0SizeLow, Layer0SizeHigh</b>	This structure member represents buffer layer #0's size in Bytes. This size lies in the range between 128K Bytes and 32G Bytes (may be changed in the future). The ChipProgUSB allows assigning buffers with fixed sizes only (see the list on the picture below). Any intermediate value will be automatically rounded up to one of the reserved buffer sizes. For example, if you enter '160000' the programmer will assign a 1MB buffer layer.
<b>BufferName</b>	Since it is used with the <a href="#">ACI CreateBuffer</a> function this structure member represents the name of the buffer that will be created. If used with the <a href="#">ACI ReallocBuffer</a> function will be ignored.
<b>BufferNumber</b>	After calling the <a href="#">ACI CreateBuffer</a> function this structure member returns the created buffer's number. After calling the <a href="#">ACI ReallocBuffer</a> function - the number of the buffer, size of which should be changed (re-allocate).
<b>NumBuffers</b>	This structure member represents the current number of memory buffers being opened.
<b>NumLayers</b>	This structure member represents the number of layers in memory buffers. This value is the same for all opened buffers.



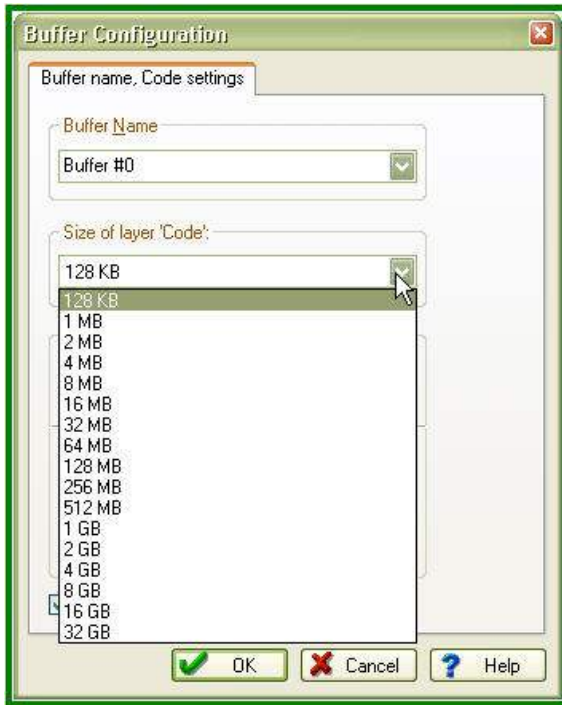

See also: [ACI\\_CreateBuffer](#), [ACI\\_ReallocBuffer](#)

#### 4.6.3.6 ACI\_Memory\_Params

```
typedef struct tagACI_Memory_Params
{
    UINT    Size;           // (in)    Size of structure, in bytes
    UINT    BufferNumber;   // (in)    Number of buffer of interest, the first buffer
number is 0
    UINT    LayerNumber;   // (in)    Number of layer of interest, the first layer
number is 0
    DWORD   AddressLow;    // (in)    Low 32 bits of address, in layer units (natural to
device address)
    DWORD   AddressHigh;   // (in)    High 32 bits of address, in layer units (natural
to device address)
    PVOID   Data;          // (in || out) Buffer to data to read to or write from
    DWORD   DataSize;      // (in)    Size of data to read or write, in layer units,
max. 16 MB (0x1000000)
    DWORD   FillValue;     // (in)    Value to fill buffer with, used by ACI_FillLayer()
only
} ACI_Memory_Params;
```

<b>BufferNumber</b>	The ordinal number of the buffer to read from or to write into. The buffer numerical order begins from zero.
<b>LayerNumber</b>	The ordinal number of the memory buffer's layer to read from or to write into.

	The layer numerical order begins from zero.
<b>AddressLow, AddressHigh</b>	The start address in the memory layer to read from or to write into represented in the units specified by the chosen device manufacturer - Bytes, Words, Double Words. This structure member is ignored in case of use with the <a href="#">ACI_FillLayer</a> function.
<b>Data</b>	Since these are used with different ACI functions this structure member has different meanings. In case of use with the <a href="#">ACI_ReadLayer</a> function it represents the pointer to the data read out from the ChipProg buffer's layer. In case of use with the <a href="#">ACI_WriteLayer</a> - the pointer to the data to be written to the ChipProg buffer's layer. The <b>Data</b> is ignored if it is used with the <a href="#">ACI_FillLayer</a> function.
<b>DataSize</b>	This structure member represents the data format given in memory units specified by the device manufacturer (Bytes, Words or Double Words). The program ignores the <b>DataSize</b> if it is used with the <a href="#">ACI_FillLayer</a> function.
<b>FillValue</b>	This is the data pattern that fills an active ChipProg buffer's layer by means of the <a href="#">ACI_FillLayer</a> function. If, for example, the <b>FillValue</b> is presented in the DWORD format then the 8-bit memory layers will be filled with the lower byte of the <b>FillValue</b> pattern, the 16-bit layers - with the lower 16-bit word and the 32-bit layers - with a whole <b>FillValue</b> pattern.

See also: [ACI\\_ReadLayer](#), [ACI\\_WriteLayer](#), [ACI\\_FillLayer](#)

#### 4.6.3.7 ACI\_Programming\_Params

```
typedef struct tagACI_Programming_Params
{
    UINT    Size;                // (in)          Size of structure, in bytes
    BOOL    InsertTest;         // (in || out)  Test if device is attached
    BOOL    CheckDeviceId;     // (in || out)  Check device identifier
    BOOL    ReverseBytesOrder; // (in || out)  Reverse bytes order in buffer
    BOOL    BlankCheckBeforeProgram; // (in || out) Perform blank check before
programming
    BOOL    VerifyAfterProgram; // (in || out)  Verify after programming
    BOOL    VerifyAfterRead;    // (in || out)  Verify after read
    BOOL    SplitData;         // (in || out)  Split data: see ACI_SP_xxx constants
    BOOL    DeviceAutoDetect;  // (in || out)  Auto detect device in socket (not
all of the programmers provide this feature)
    BOOL    DialogBoxOnError;  // (in || out)  On error, display dialog box
    UINT    AutoDetectAction;  // (in || out)  Action to perform on device
autodetect or 'Start' button, see ACI_AD_xxx constants
    DWORD   DeviceStartAddrLow; // (in || out)  Low 32 bits of device start address
for programming operation
    DWORD   DeviceStartAddrHigh; // (in || out)  High 32 bits of device start address
for programming operation
    DWORD   DeviceEndAddrLow;   // (in || out)  Low 32 bits of device end address
for programming operation
}
```

```

    DWORD DeviceEndAddrHigh;        // (in || out) High 32 bits of device end address
for programming operation
    DWORD DeviceBufStartAddrLow;    // (in || out) Low 32 bits of device memory start
address in buffer for programming operation
    DWORD DeviceBufStartAddrHigh;  // (in || out) High 32 bits of device memory start
address in buffer for programming operation
} ACI_Programming_Params;

```

<b>InsertTest</b>	This is the command to <a href="#">check the device insertion</a> before starting any programming operations on the device. The procedure will check if every chip leads have good contact in the programming socket.								
<b>CheckDeviceId</b>	This is the command to check a unique internal device identifier before the device programming.								
<b>ReverseBytesOrder</b>	This is the command to reverse the byte order in 16-bit words when programming the device, reading it or verifying the data. This structure member does not effect the data value in the ChipProg memory buffers - these data remain the same as they were loaded.								
<b>BlankCheckBeforeProgram</b>	This is the command to check whether the <a href="#">device is blank</a> before executing the <a href="#">Program</a> command.								
<b>VerifyAfterProgram</b>	This is the command to <a href="#">verify</a> the data written into the device every time after executing the <a href="#">Program</a> command.								
<b>VerifyAfterRead</b>	This is the command to <a href="#">verify</a> the data written into the device every time after executing the <a href="#">Read</a> command.								
<b>SplitData</b>	This is the command to <a href="#">split</a> data in accordance with the value of the constants <b>ACI_SP_xxx*</b> in the aciprog.h file (see below). This allows 8-bit memory devices to be cascaded in multiple memory chips to be used in the systems with 16- and 32-bit address and data buses.								
<b>DeviceAutoDetect</b>	This is the command to scan all the device's leads in a process of the device insertion into the programming socket. If the <b>DeviceAutoDetect</b> is TRUE the programmer will check whether all of the device's leads are reliably gripped by the programmer socket's sprung contacts. Only when the reliable <a href="#">device insertion</a> is acknowledged, the program launches a chosen programming operation, <a href="#">script</a> or a batch of single operations programmed in the <a href="#">Auto Programming</a> dialog.								
<b>DialogBoxOnError</b>	If this structure member is TRUE then any error that occurs in any programming operation will generate error messages and will open associated dialogs. If this attribute is FALSE the error messages will not be issued.								
<b>AutoDetectAction</b>	<p>If the <b>DeviceAutoDetect</b> is TRUE then values of the <b>ACI_AD_xxx**</b> constants in the aciprog.h file define a particular action triggered either on manual pushing the <b>Start</b> button or upon auto detection of <a href="#">reliable insertion</a> of the device into the programmer's socket (see below).</p> <table border="1"> <thead> <tr> <th>AutoDetectAction value</th> <th>What to do (action)</th> </tr> </thead> <tbody> <tr> <td>ACI_AD_EXEC_FUNCTION</td> <td>Launch the programming operation (function) currently highlighted in the <a href="#">Program Manager tab</a>.</td> </tr> <tr> <td>ACI_AD_EXEC_AUTO</td> <td>Launch a batch of single operations programmed in the <a href="#">Auto Programming</a> dialog.</td> </tr> <tr> <td>ACI_AD_EXEC_SCRIPT</td> <td>Perform the script specified in the <a href="#">Script File</a> dialog.</td> </tr> </tbody> </table>	AutoDetectAction value	What to do (action)	ACI_AD_EXEC_FUNCTION	Launch the programming operation (function) currently highlighted in the <a href="#">Program Manager tab</a> .	ACI_AD_EXEC_AUTO	Launch a batch of single operations programmed in the <a href="#">Auto Programming</a> dialog.	ACI_AD_EXEC_SCRIPT	Perform the script specified in the <a href="#">Script File</a> dialog.
AutoDetectAction value	What to do (action)								
ACI_AD_EXEC_FUNCTION	Launch the programming operation (function) currently highlighted in the <a href="#">Program Manager tab</a> .								
ACI_AD_EXEC_AUTO	Launch a batch of single operations programmed in the <a href="#">Auto Programming</a> dialog.								
ACI_AD_EXEC_SCRIPT	Perform the script specified in the <a href="#">Script File</a> dialog.								

	ACI_AD_DO_NOTHING G	Do not act (ignore). Then it is possible to resume operations only by executing either the <a href="#">ACI ExecFunction</a> or <a href="#">ACI StartFunction</a> .
<b>DeviceStartAddrLow, DeviceStartAddrHigh</b>	This structure member defines a physical start address of the device to perform a specified programming operation (function). For example: "...read the chip content beginning at the address 7Fh". Not all the functions use this parameter.	
<b>DeviceEndAddrLow, DeviceEndAddrHigh</b>	This parameter defines a physical end address, beyond which a specified programming operation (function) will not proceed. For example: "...program the chip until the address 0FFh". Not all the programmer functions use this parameter.	
<b>DeviceBufStartAddrLow, DeviceBufStartAddrHigh</b>	This structure member defines the buffers layer's start address from which to perform a specified programming operation (function). For example: "...read the chip and move the data to the buffer beginning at the address 10h". Not all the programmer functions use this parameter.	

This is the bit definition from the `aciprogram.h` header file:

```
* // ACI Data Split defines
#define ACI_SP_NONE                0
#define ACI_SP_EVEN_BYTE          1
#define ACI_SP_ODD_BYTE           2
#define ACI_SP_BYTE_0             3
#define ACI_SP_BYTE_1             4
#define ACI_SP_BYTE_2             5
#define ACI_SP_BYTE_3             6

** // ACI Device Auto-Detect or 'Start' button action
#define ACI_AD_EXEC_FUNCTION      0 // Execute the function currently selected in the list
#define ACI_AD_EXEC_AUTO          1 // Execute the Auto Programming command
#define ACI_AD_EXEC_SCRIPT        2 // Execute the script chosen in the programmer Script File
dialog
#define ACI_AD_DO_NOTHING         3 // Do nothing
```

See also: [ACI\\_SetProgrammingParams](#), [ACI\\_GetProgrammingParams](#)

#### 4.6.3.8 ACI\_ProgOption\_Params

```
typedef struct tagACI_ProgOption_Params
{
    UINT    Size;                // (in)    Size of structure, in bytes
    LPCSTR  OptionName;          // (in)    Name of the option. For lists, it should be in
the form "List array name^List Name", e.g. "Configuration Bits^Oscillator"
    CHAR    Units[32];           // (out)   Option measurement units ("kHz", "V", etc.)
    CHAR    OptionDescription[64]; // (out)   Description of the option
    CHAR    ListString[64];      // (out)   For ACI_PO_LIST option: Option string for
Value.ListIndex
```

```

UINT  OptionType;          // (out) Option type: see ACI_PO_xxx constants
BOOL  ReadOnly;           // (out) Option is read-only
union                                // (in || out) Option value
{
    LONG  LongValue;        // (in || out) Value for ACI_PO_LONG option
    FLOAT FloatValue;      // (in || out) Value for ACI_PO_FLOAT option
    LPSTR String;          // (in || out) Pointer to string for ACI_PO_STRING option
    ULONG CheckBoxesValue; // (in || out) Value for ACI_PO_CHECKBOXES option
    UINT  StateIndex;      // (in || out) State index for ACI_PO_LIST option
    LPBYTE Bitstream;      // (in || out) Pointer to bitstream data for
ACI_PO_BITSTREAM option
} Value;

UINT  VSize;              // For ACI_SetProgOption():
                          //   in: Size of Bitstream if OptionType ==
ACI_PO_BITSTREAM

                          // For ACI_GetProgOption():
                          //   in: Size of buffer pointed by Bitstream if
OptionType == ACI_PO_BITSTREAM
                          //   in: Size of buffer pointed by String if OptionType
== ACI_PO_STRING
                          //   out: Size of buffer needed for storing Bitstream
data if OptionType == ACI_PO_BITSTREAM.
                          //   Set Value.Bitstream to NULL to get buffer size
without setting the bitstream data
                          //   out: Size of buffer needed for storing String if
OptionType == ACI_PO_STRING, including the terminating NULL character.
                          //   Set Value.String to NULL to get buffer size
without setting the string
    UINT  Mode;           // (in) For ACI_SetProgOption(): SEE ACI_PP_MODE_...
constants
} ACI_ProgOption_Params;

```

<b>OptionName</b>	The name of the programming option - for example "Vcc". For the <b>ACI_PO_LIST</b> - <b>type</b> options, where the options are grouped into a list, you should specify both the list name and the option name in the following way: <List name>^<Option name> (For example, <b>Configuration_bits^Generator</b> . There are no restrictions on use of uppercase and lowercase characters in the option names.
<b>Units</b>	After executing the <a href="#">ACI_GetProgOption</a> function this structure member returns an abbreviation of the units, in which the programmer represents or measures the <b>OptionName</b> . For example, for the Vcc structure member, Units = "V".
<b>OptionDescription</b>	After executing the <a href="#">ACI_GetProgOption</a> function this structure member returns the option description.
<b>ListString</b>	After executing the <a href="#">ACI_GetProgOption</a> function for the <b>ACI_PO_LIST</b> - type options this structure member returns a string that describes the current option's value or status. For example, <b>XT - Standard Crystal</b> for the option <b>Configuration bits^Generator</b> .
<b>OptionType</b>	After executing the <a href="#">ACI_GetProgOption</a> function this structure member returns the option's presentation format - for example: integer, floating point, list, bitstream, etc.. See the <b>ACI_PO_xxx*</b> constant description in the aciprog.h

	header file below.														
<b>ReadOnly</b>	Setting <b>ReadOnly=TRUE</b> disables modification of the option specified by the <a href="#">ACI_GetProgOption</a> function.														
<b>Value</b>	<p>Use of this union depends on the <b>ACI_PO_LONG*</b> option type as it is shown in the matrix below:</p> <table border="1"> <thead> <tr> <th>Option type</th> <th>Use of the Value union</th> </tr> </thead> <tbody> <tr> <td>ACI_PO_LONG</td> <td>The option is in the <b>Value.LongValue</b></td> </tr> <tr> <td>ACI_PO_FLOAT</td> <td>The option is in the <b>Value.FloatValue</b></td> </tr> <tr> <td>ACI_PO_STRING</td> <td>The option is represented as a string, the pointer on which is in the <b>Value.String</b>. See the <a href="#">note below</a>.</td> </tr> <tr> <td>ACI_PO_CHECKBOXES</td> <td>The option represents a 32-bit integer word, in which you can individually toggle each bit that represents a particular flag in the option setting dialog. The option is in the <b>Value.CheckBoxesValue</b>. See, for example, the Fuse setting dialog for the ATtiny45 MCU implemented as an array of <a href="#">check boxes</a>.</td> </tr> <tr> <td>ACI_PO_LIST</td> <td>It represents a list of alternative choices. Only one of them can be selected at a time, so the parameter changes its value in a range 0, 1, 2 to N. The option is in the <b>Value.CheckStateIndex</b>. See, for example, the Oscillators setting dialog for the PIC12F509 MCU implemented as an alternatively chosen <a href="#">radio buttons</a></td> </tr> <tr> <td>ACI_PO_BITSTREAM</td> <td>Stream of bits. This option type is not in use yet but can be used for future applications.</td> </tr> </tbody> </table>	Option type	Use of the Value union	ACI_PO_LONG	The option is in the <b>Value.LongValue</b>	ACI_PO_FLOAT	The option is in the <b>Value.FloatValue</b>	ACI_PO_STRING	The option is represented as a string, the pointer on which is in the <b>Value.String</b> . See the <a href="#">note below</a> .	ACI_PO_CHECKBOXES	The option represents a 32-bit integer word, in which you can individually toggle each bit that represents a particular flag in the option setting dialog. The option is in the <b>Value.CheckBoxesValue</b> . See, for example, the Fuse setting dialog for the ATtiny45 MCU implemented as an array of <a href="#">check boxes</a> .	ACI_PO_LIST	It represents a list of alternative choices. Only one of them can be selected at a time, so the parameter changes its value in a range 0, 1, 2 to N. The option is in the <b>Value.CheckStateIndex</b> . See, for example, the Oscillators setting dialog for the PIC12F509 MCU implemented as an alternatively chosen <a href="#">radio buttons</a>	ACI_PO_BITSTREAM	Stream of bits. This option type is not in use yet but can be used for future applications.
Option type	Use of the Value union														
ACI_PO_LONG	The option is in the <b>Value.LongValue</b>														
ACI_PO_FLOAT	The option is in the <b>Value.FloatValue</b>														
ACI_PO_STRING	The option is represented as a string, the pointer on which is in the <b>Value.String</b> . See the <a href="#">note below</a> .														
ACI_PO_CHECKBOXES	The option represents a 32-bit integer word, in which you can individually toggle each bit that represents a particular flag in the option setting dialog. The option is in the <b>Value.CheckBoxesValue</b> . See, for example, the Fuse setting dialog for the ATtiny45 MCU implemented as an array of <a href="#">check boxes</a> .														
ACI_PO_LIST	It represents a list of alternative choices. Only one of them can be selected at a time, so the parameter changes its value in a range 0, 1, 2 to N. The option is in the <b>Value.CheckStateIndex</b> . See, for example, the Oscillators setting dialog for the PIC12F509 MCU implemented as an alternatively chosen <a href="#">radio buttons</a>														
ACI_PO_BITSTREAM	Stream of bits. This option type is not in use yet but can be used for future applications.														
<b>VSize</b>	Size of the buffer assigned for storing the string if the option type is the <b>ACI_PO_STRING</b> . See the <a href="#">note below</a> .														
<b>Mode</b>	<p>Mode of using of the structure member Value (See the description of the <b>ACI_PP_xxx**</b> constants in the <code>aciprogram.h</code>) header file:</p> <table border="1"> <thead> <tr> <th>The Mode setting (value)</th> <th>Use of the parameter Value</th> </tr> </thead> <tbody> <tr> <td>ACI_PP_MODE_VALUE</td> <td>1) For measuring (getting): use the <b>Value</b> in order to get an actual <b>Option</b> value; 2) For setting: use the <b>Value</b> to set a particular <b>Option</b> value.</td> </tr> <tr> <td>ACI_PP_MODE_DEFAULT_VALUE</td> <td>1) If used with the <a href="#">ACI_GetProgOption</a> function it issues a command to put the default <b>Option</b> value into the <b>Value</b>. 2) If used with the <a href="#">ACI_SetProgOption</a> function, the <b>Value</b> will be ignored; the <b>Option</b> will be set to the default level defined in the ChipProg hardware.</td> </tr> <tr> <td>ACI_PP_MODE_MIN_VALUE</td> <td>1) If used with the <a href="#">ACI_GetProgOption</a> function it commands to put the minimal <b>Option</b> value into the <b>Value</b>. 2) If used with the <a href="#">ACI_SetProgOption</a> function the <b>Value</b> will be ignored; the <b>Option</b> will be set to the minimal level defined in the ChipProg hardware, if it is possible for the <b>Option</b> of this type.</td> </tr> <tr> <td>ACI_PP_MODE_MAX_VALUE</td> <td>1) If used with the <a href="#">ACI_GetProgOption</a> function it commands to put the maximal <b>Option</b> value into the <b>Value</b>. 2) If it is used with the <a href="#">ACI_SetProgOption</a> function the <b>Value</b> will be ignored; the <b>Option</b> will be set to the maximal</td> </tr> </tbody> </table>	The Mode setting (value)	Use of the parameter Value	ACI_PP_MODE_VALUE	1) For measuring (getting): use the <b>Value</b> in order to get an actual <b>Option</b> value; 2) For setting: use the <b>Value</b> to set a particular <b>Option</b> value.	ACI_PP_MODE_DEFAULT_VALUE	1) If used with the <a href="#">ACI_GetProgOption</a> function it issues a command to put the default <b>Option</b> value into the <b>Value</b> . 2) If used with the <a href="#">ACI_SetProgOption</a> function, the <b>Value</b> will be ignored; the <b>Option</b> will be set to the default level defined in the ChipProg hardware.	ACI_PP_MODE_MIN_VALUE	1) If used with the <a href="#">ACI_GetProgOption</a> function it commands to put the minimal <b>Option</b> value into the <b>Value</b> . 2) If used with the <a href="#">ACI_SetProgOption</a> function the <b>Value</b> will be ignored; the <b>Option</b> will be set to the minimal level defined in the ChipProg hardware, if it is possible for the <b>Option</b> of this type.	ACI_PP_MODE_MAX_VALUE	1) If used with the <a href="#">ACI_GetProgOption</a> function it commands to put the maximal <b>Option</b> value into the <b>Value</b> . 2) If it is used with the <a href="#">ACI_SetProgOption</a> function the <b>Value</b> will be ignored; the <b>Option</b> will be set to the maximal				
The Mode setting (value)	Use of the parameter Value														
ACI_PP_MODE_VALUE	1) For measuring (getting): use the <b>Value</b> in order to get an actual <b>Option</b> value; 2) For setting: use the <b>Value</b> to set a particular <b>Option</b> value.														
ACI_PP_MODE_DEFAULT_VALUE	1) If used with the <a href="#">ACI_GetProgOption</a> function it issues a command to put the default <b>Option</b> value into the <b>Value</b> . 2) If used with the <a href="#">ACI_SetProgOption</a> function, the <b>Value</b> will be ignored; the <b>Option</b> will be set to the default level defined in the ChipProg hardware.														
ACI_PP_MODE_MIN_VALUE	1) If used with the <a href="#">ACI_GetProgOption</a> function it commands to put the minimal <b>Option</b> value into the <b>Value</b> . 2) If used with the <a href="#">ACI_SetProgOption</a> function the <b>Value</b> will be ignored; the <b>Option</b> will be set to the minimal level defined in the ChipProg hardware, if it is possible for the <b>Option</b> of this type.														
ACI_PP_MODE_MAX_VALUE	1) If used with the <a href="#">ACI_GetProgOption</a> function it commands to put the maximal <b>Option</b> value into the <b>Value</b> . 2) If it is used with the <a href="#">ACI_SetProgOption</a> function the <b>Value</b> will be ignored; the <b>Option</b> will be set to the maximal														

	level defined in the ChipProg hardware, if it is possible for the <b>Option</b> of this type.
--	---

**This is the bit definition from the aciprogram.h header file:**

***\*/* ACI Programming Options defines**

```
#define ACI_PO_LONG           0 // Signed integer option
#define ACI_PO_FLOAT         1 // Floating point option
#define ACI_PO_STRING        2 // String option
#define ACI_PO_CHECKBOXES   3 // 32-bit array of bits
#define ACI_PO_LIST          4 // List (radiobuttons)
#define ACI_PO_BITSTREAM    5 // Bit stream - variable size bit array
```

***\*\** ACI Programming Option Mode constants for ACI\_GetProgOption()/ACI\_SetProgOption()**

```
#define ACI_PP_MODE_VALUE    0 // Get/set value specified in Value member of the
ACI_ProgOption_Params structure
#define ACI_PP_MODE_DEFAULT_VALUE 1 // Get/set default option value, ignore Value member
#define ACI_PP_MODE_MIN_VALUE  2 // Get/set minimal option value, ignore Value
member
#define ACI_PP_MODE_MAX_VALUE  3 // Get/set maximal option value, ignore Value
member
```

**Note for use of the [ACI\\_GetProgOption](#):**

In order to get the buffer size necessary for storing the Option ACI\_PO\_STRING, you should make the first call of the ACI\_GetProgOption function with the Value.String= NULL. Then the function will return the VSize equal to the buffer size, including zero at the string's end. In your program, assign the buffer of this size, put the Value.String into the buffer pointer and call the ACI\_GetProgOption again.

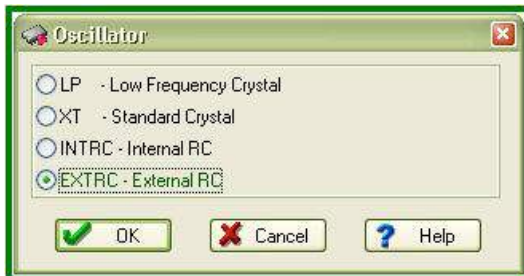
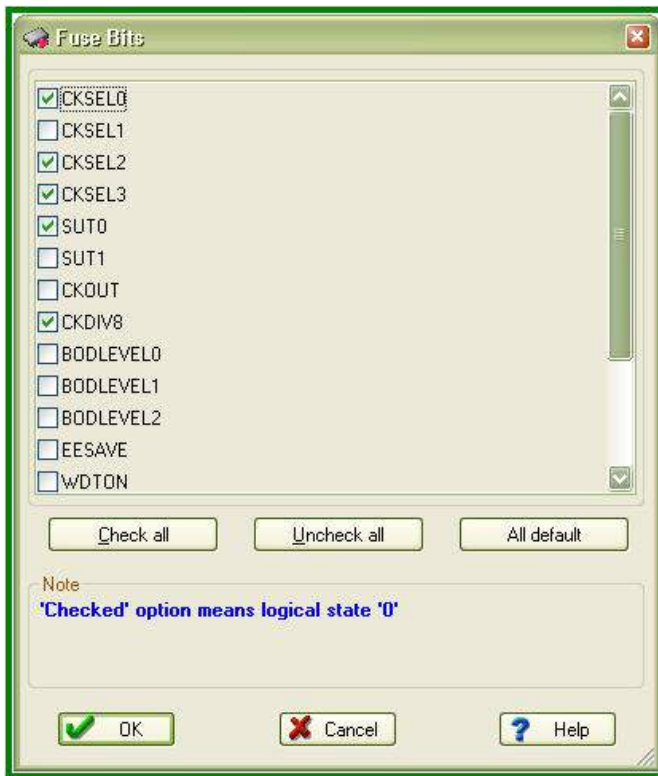

See also: [ACI\\_GetProgOption](#), [ACI\\_SetProgOption](#)

#### 4.6.3.9 ACI\_Function\_Params

```
typedef struct tagACI_Function_Params
{
    UINT    Size;                // (in)  Size of structure, in bytes
    LPCSTR  FunctionName;        // (in)  Name of a function to execute. If a function is
                                // under a sub-menu, use '^' to separate menu name from function name, e.g. "Lock
                                // Bits^Bit 0"
                                // To execute Auto Programming, set FunctionName
                                // to NULL, empty string or "Auto Programming".
    UINT    BufferNumber;         // (in)  Buffer number to use
    BOOL    Silent;              // (in)  On error, do not display error message box,
                                // just copy error string to ErrorMessage
    CHAR    ErrorMessage[512];   // (out) Error message string if ACI_ExecFunction()
                                // fails
}
```



```
} ACI_Function_Params;
```

<b>FunctionName</b>	<p>The name of the ChipProg function is one of those listed in the window <b>Functions</b> of the ChipProgUSB <a href="#">Program Manager tab</a>. They are divided in two group (see the picture below): (1) the main functions applicable to a majority of the target devices (<b>Blank Check, Erase, Read, Program, Verify</b>) and (2) the device-specific lower level functions accessible through expandable sub-menus (for example, <b>Program Device Parameters, Erase Sectors, Lock Bits &gt; Program Lock Bit 1, EEPROM &gt; Read</b>, etc.). For such device-specific functions the <b>FunctionName</b> should be specified in the following way: <b>&lt;List name&gt;^&lt;Function name&gt;</b> (for example, <b>Device Parameters^Program</b>).</p> <p>To launch the <b>AutoProgramming</b> batch set the <b>FunctionName</b> either to NULL, a blank string, or the "Auto Programming".</p> <p>There is no restrictions in use of uppercase and lowercase characters in the function names.</p>
<b>BufferNumber</b>	The ordinal number of the buffer the function operates with.
<b>Silent</b>	If this parameter is TRUE, then the error message dialog will be suppressed, the function execution will be terminated and will return the <b>ACI_ERR_FUNCTION_FAILED</b> code, and the error message will be copied to the <b>ErrorMessage</b> .
<b>ErrorMessage</b>	The destination of the error message that will be issued if the function fails.

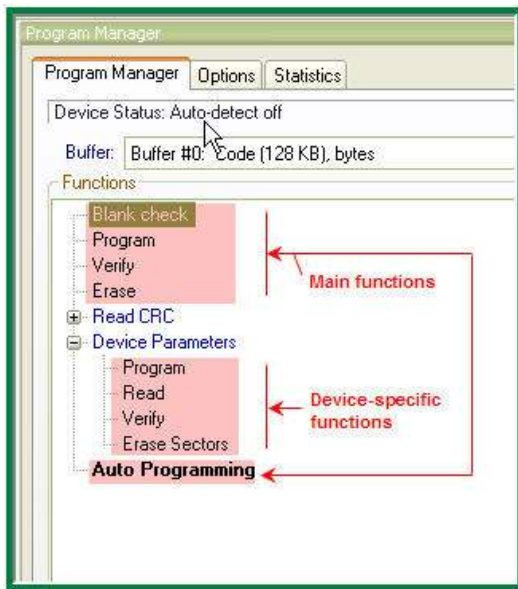

See also: [ACI ExecFunction](#), [ACI StartFunction](#), [ACI GetStatus](#)

#### 4.6.3.10 ACI\_GangTerminate\_Params

```
typedef struct tagACI_GangTerminate_Params
{
    UINT    Size;                // (in)    Size of structure, in bytes
    INT     SiteNumber;          // (in)    Site number to terminate operation (-1 == all
sites)
    INT     Timeout;             // (in)    Timeout in milliseconds (-1 == infinite) to
wait for operation break
    BOOL    SiteStopped;        // (out)   TRUE if operation was stopped, FALSE if timeout
occurred
} ACI_GangTerminate_Params;
```

<b>SiteNumber</b>	The site (socket) number you want terminating a current operation on. Socket numbers begin from 0 (zero). If you specify SiteNumber = -1 (minus one) this will terminate operations on all sites of the gang machine.
<b>Timeout</b>	A time interval in milliseconds, during of which the <a href="#">ACI_GangTerminateFunction</a> holds expecting an acknowledgment of the successful operation termination. The function will return control either upon getting such an acknowledgment or upon expiring a specified Timeout.  If you specify the Timeout = -1 (minus one) it will never expire.
<b>SiteStopped</b>	This parameter indicates whether the <a href="#">ACI_GangTerminateFunction</a> succeeded. In case of successful termination an operation <i>before</i> expiring the Timeout the SiteStopped parameter sets TRUE. Otherwise, it will be set FALSE.

See also: [ACI\\_GangTerminateFunction](#), [ACI\\_TerminateFunction](#).

#### 4.6.3.11 ACI\_PStatus\_Params

```
typedef struct tagACI_PStatus_Params
{
    UINT    Size;                // (in)    Size of structure, in bytes
    UINT    SiteNumber;          // (in)    For the Gang mode: site number to get status of, oth
    BOOL    Executing;           // (out)   The function started by ACI_StartFunction() is
executing
    UINT    PercentComplete;     // (out)   Percentage of the function completion, valid id
Executing != FALSE
    UINT    DeviceStatus;        // (out)   Device/socket status, see the ACI_DS_XXX
constants
    BOOL    NewDevice;           // (out)   New device inserted, no function has been
executed yet. Valid if DeviceAutoDetect is ON.
    BOOL    FunctionFailed;      // (out)   TRUE if last function failed
    CHAR    FunctionName[128];   // (out)   Name of a function being executed if Executing
!= FALSE. If a function is under a sub-menu, function name will be like this: "Lock
Bits^Bit 0"
    CHAR    ErrorMessage[512];   // (out)   Error message string if FunctionFailed != FALSE
} ACI_PStatus_Params;
```

<b>SiteNumber</b>	If the ChipProgUSB was launched in the Gang mode (with the command line key / gang) and controls either the gang programmer or a cluster of single programming machines, then before starting the <a href="#">ACI_GetStatus</a> function the <b>SiteNumber</b> parameter must contain the ordinal number of the programming site (socket) for which the status is required. The site numbers begin from #0.												
<b>Executing</b>	This parameter is TRUE while the ChipProg operation, launched by the <a href="#">ACI_StartFunction</a> , is in progress.												
<b>PercentCompleted</b>	While the <b>Executing</b> == TRUE this parameter represents a percentage of the function completion - from 0 to 100.												
<b>DeviceStatus</b>	<p>This structure member defines insertion of the device into the programmer ZIF socket if the <a href="#">device insertion auto detection</a> function is enabled. See the description of the <b>ACI_DS_XXX*</b> constants in the aciprogram.h file. See the matrix below:</p> <table border="1"> <thead> <tr> <th>Status</th> <th>Description</th> </tr> </thead> <tbody> <tr> <td>ACI_DS_OK</td> <td>The device is in the socket and the device's leads are reliably gripped by the programmer's ZIF socket's sprung contacts.</td> </tr> <tr> <td>ACI_DS_OUT_OF_SOCKET</td> <td>There is no device in the programmer's ZIF socket.</td> </tr> <tr> <td>ACI_DS_SHIFTED</td> <td>The device's leads are reliably inserted into the socket but the device is incorrectly positioned in the socket (shifted or inserted upside down). The same status may indicate that the device type selected in the <a href="#">Select Device</a> does not correspond to the type of chip in the programmer's socket.</td> </tr> <tr> <td>ACI_DS_BAD_CONTACT</td> <td>The device's leads are not reliably gripped by the socket's sprung contacts. In most cases this is an intermediate situation while an operator is inserting the chip to the socket or is removing it.</td> </tr> <tr> <td>ACI_DS_UNKNOWN</td> <td>It is impossible to detect the status because the <a href="#">device insertion auto detection</a> feature is disabled or this feature is not supported by this programmer at all.</td> </tr> </tbody> </table>	Status	Description	ACI_DS_OK	The device is in the socket and the device's leads are reliably gripped by the programmer's ZIF socket's sprung contacts.	ACI_DS_OUT_OF_SOCKET	There is no device in the programmer's ZIF socket.	ACI_DS_SHIFTED	The device's leads are reliably inserted into the socket but the device is incorrectly positioned in the socket (shifted or inserted upside down). The same status may indicate that the device type selected in the <a href="#">Select Device</a> does not correspond to the type of chip in the programmer's socket.	ACI_DS_BAD_CONTACT	The device's leads are not reliably gripped by the socket's sprung contacts. In most cases this is an intermediate situation while an operator is inserting the chip to the socket or is removing it.	ACI_DS_UNKNOWN	It is impossible to detect the status because the <a href="#">device insertion auto detection</a> feature is disabled or this feature is not supported by this programmer at all.
Status	Description												
ACI_DS_OK	The device is in the socket and the device's leads are reliably gripped by the programmer's ZIF socket's sprung contacts.												
ACI_DS_OUT_OF_SOCKET	There is no device in the programmer's ZIF socket.												
ACI_DS_SHIFTED	The device's leads are reliably inserted into the socket but the device is incorrectly positioned in the socket (shifted or inserted upside down). The same status may indicate that the device type selected in the <a href="#">Select Device</a> does not correspond to the type of chip in the programmer's socket.												
ACI_DS_BAD_CONTACT	The device's leads are not reliably gripped by the socket's sprung contacts. In most cases this is an intermediate situation while an operator is inserting the chip to the socket or is removing it.												
ACI_DS_UNKNOWN	It is impossible to detect the status because the <a href="#">device insertion auto detection</a> feature is disabled or this feature is not supported by this programmer at all.												
<b>NewDevice</b>	This structure member is a flag that acknowledges replacing a programmed device in the programmer's socket by a new, presumably a blank device. It works only when the <a href="#">device insertion auto detection</a> function is enabled. The <b>NewDevice</b> == FALSE while the already programmed chip is still in the socket and has not been replaced by a new one. After removing the programmed device from the socket the <b>NewDevice</b> toggles to TRUE.												
<b>FunctionFailed</b>	This is an indicator of the function execution's result. It is set to FALSE when the <a href="#">ACI_StartFunction</a> launches a programming operation and remains FALSE while the operation is in progress. If the programming operation fails and the parameter <b>Executing</b> becomes FALSE the <b>FunctionFailed</b> flag toggles to TRUE.												

<b>FunctionName</b>	This is either the name of the programming operation (function) being currently executed or the name of the failed function, if the <b>FunctionFailed</b> == TRUE.
<b>ErrorMessage</b>	The destination of the error message if the function fails, i.e. the <b>FunctionFailed</b> == TRUE.

This is the bit definition from the `aciprogram.h` header file:

```

*/ ACI Device Status
#define ACI_DS_OK                0 // Device detected, pin contacts are ok
#define ACI_DS_OUT_OF_SOCKET    1 // No device in the socket
#define ACI_DS_SHIFTED         2 // Wrong device insertion is detected (shifted or inserted
upside down)
#define ACI_DS_BAD_CONTACT      3 // Bad pin contact(s)
#define ACI_DS_UNKNOWN          4 // Unknown (Auto Detect is probably off)

```

See also: [ACI\\_ExecFunction](#), [ACI\\_StartFunction](#), [ACI\\_GetStatus](#)

#### 4.6.3.12 ACI\_File\_Params

```

typedef struct tagACI_File_Params
{
    UINT    Size;                // (in)  Size of structure, in bytes
    LPCSTR  FileName;           // (in)  File name
    UINT    BufferNumber;        // (in)  Buffer number
    UINT    LayerNumber;        // (in)  Layer number
    UINT    Format;              // (in)  File format: see ACI_PLF_... and ACI_PSF_...
    constants
    DWORD   StartAddressLow;     // (in)  Low 32 bits of start address for ACI_FileSave
() .
                                //      For ACI_FileLoad(): Ignored if Format !=
ACI_PLF_BINARY
    DWORD   StartAddressHigh;    // (in)  High 32 bits of start address for ACI_FileSave
() .
                                //      For ACI_FileLoad(): Ignored if Format !=
ACI_PLF_BINARY
    DWORD   EndAddressLow;       // (in)  ACI_FileSave(): Low 32 bits of end address
    DWORD   EndAddressHigh;     // (in)  ACI_FileSave(): High 32 bits of end address
    DWORD   OffsetLow;          // (in)  Low 32 bits of address offset for ACI_FileLoad
()
    DWORD   OffsetHigh;         // (in)  High 32 bits of address offset for ACI_FileLoad
()
} ACI_File_Params;

```

<b>FileName</b>	The name of the file to be loaded to the ChipProg buffer.
<b>BufferNumber</b>	The ordinal number of the destination buffer. Buffer numbers begins from zero.
<b>LayerNumber</b>	The ordinal number of the memory layer in the buffer. Layer numbers begins

	from zero.
<b>Format</b>	The loadable file's format. See the description of the <b>ACI_PLF_XXX*</b> constants in the aciprogram.h header file (see below).
<b>StartAddressLow, StartAddressHigh</b>	1) If used with the <a href="#">ACI_FileSave</a> function this parameter specifies the first (start) address in the source memory layer, from which the file will be saved. 2) If used with the <a href="#">ACI_FileLoad</a> function, but only when it loads a file in the binary format (Format == ACI_PLF_BINARY), this parameter specifies the first (start) address of the destination memory layer, in which the file will be loaded. Binary images do not carry any addresses for the file loading.
<b>EndAddressLow, EndAddressHigh</b>	If used with the <a href="#">ACI_FileSave</a> function this parameter defines the last (end) address of the source memory layer, from which the file will be saved.
<b>OffsetLow, OffsetHigh</b>	The address offset that shifts the file position in the destination memory layer. The offset can be negative as well as positive.

This is the bit definition from the aciprogram.h header file:

```

*/ ACI File formats for ACI_FileLoad()
#define ACI_PLF_INTEL_HEX          0 // Standard/Extended Intel HEX
#define ACI_PLF_BINARY             1 // Binary image
#define ACI_PLF_MOTOROLA_S        2 // Motorola S-record
#define ACI_PLF_POF               3 // POF
#define ACI_PLF_JEDEC              4 // JEDEC
#define ACI_PLF_PRG                5 // PRG
#define ACI_PLF_OTP                6 // Holtek OTP
#define ACI_PLF_SAV                7 // Angstrom SAV
#define ACI_PLF_ASCII_HEX         8 // ASCII Hex
#define ACI_PLF_ASCII_OCTAL       9 // ASCII Octal
    
```

See also: [ACI\\_FileLoad](#), [ACI\\_FileSave](#).

#### 4.6.3.13 ACI\_GangStart\_Params

```

typedef struct tagACI_GangStart_Params
{
    UINT    Size;                // (in)  Size of structure, in bytes
    UINT    SiteNumber;         // (in)  Site number to start auto programming at
    UINT    BufferNumber;       // (in)  Buffer number to use
    BOOL    Silent;             // (in)  On error, do not display error message box. Use
} ACI_GangStart_Params;
    
```

<b>SiteNumber</b>	The number of the device programmer socket in the gang programmer or in a programming cluster comprised of multiple ChipProg programmers for which the <a href="#">ACI_GangStart</a> function is launched. The site (socket) numbers begin from #0.
<b>BufferNumber</b>	The ordinal number of the <a href="#">memory buffer</a> , content of which is required by the <a href="#">ACI_GangStart</a> function. Numbers of ChipProg memory buffers begin from #0.

<b>Silent</b>	If this parameter is TRUE, then the error message dialog will be suppressed, the function execution will be terminated and the <b>ACI_ERR_FUNCTION_FAILED</b> code will be returned.. Use the <a href="#">ACI_GetStatus</a> function to receive the error message.
---------------	--

See also: [ACI\\_GangStart](#), [ACI\\_GetStatus](#)

#### 4.6.3.14 ACI\_Connection\_Params

```
typedef struct tagACI_Connection_Params
{
    UINT    Size;                // (in) Size of structure, in bytes
    LPVOID  ConnectionId;       // ACI_SetConnection(): (in),
    ACI_GetConnection(): (out)  // Connection identifier
} ACI_Connection_Params;
```

<b>ConnectionId</b>	An identifier of the connection with a particular device programmer. This is an abstract parameter that means nothing for the ACI user.
---------------------	---

See also: [ACI\\_SetConnection](#), [ACI\\_GetConnection](#).

#### 4.6.4 Examples of use

The ChipProgUSB software includes a few examples of use the **Application Control Interface** functions and structures. The examples reside in the subdirectory **ACI\Programmer ACI Examples** in the directory where the ChipProg program is installed.

The examples are written in the C language. They represent the projects that can be compiled by Microsoft Visual Studio® 2008. The project sources can also be compiled by other C/C++ compilers, sometimes with minor adjustments. After building the project you get the Windows consol application executable file.

In order to adjust the example project (or a part of it) for use in your application you have to set correct paths to the ACI functions called by the main() function. This includes paths to the ChipProg executable file, to the file that is supposed to be loaded to the programmer's memory buffer or to be saved from the buffer. You also have to specify your target device. See an example of the main() function's fragment below.

```
/*+          main          °          01.07.09 17:37:24*/
.....

// Launch the programmer executable
if (!Attach("C:\Program Files\ChipProgUSB\4_72_00\UProgt2.exe", "", FALSE)) return -1;

// Select device to operate on
if (!SetDevice("Microchip", "PIC18F242")) return -1;
```

```
// Load .hex file to buffer 0, layer 0
if (!LoadHexFile("C:\\Program\\test.hex", 0, 0)) return -1;
```

....

All examples uses the ACI.DLL file that must be either in the same folder where the example executable file resides or in the folder specified in the variable PATH. In the supplied examples the ACI.DLL file is already copied into the folders where the MS Visual Studio creates executable files.

### Example Descriptions

Each example has a comment header briefly describing the program purposes. Additionally, some comments are inserted in the code texts. All examples begin from executing the [ACI\\_Launch\(\)](#) function that activates the programmer.

#### AutoProgramming.c

This is the simplest and most frequently used example of the ChipProg external control. The program launches the programmer, selects the PIC18F242 target device, loads the test.hex file into the programmer buffer, sets default programming options and then executes a preset [Auto Programming](#) batch of functions: Erase, Blank Check, Program, Verify.

#### LongProgramming.c

This example shows how to monitor a process of the AutoProgramming procedure if it may last quite a long time. The program acts as the example above. The programming launches by the [ACI\\_StartFunction](#). Then it keeps checking the percentage of the operation completion by means of the [ACI\\_GetStatus](#) function. If the operation fails, the programmer issues an error message; otherwise it allows operation to continue.

#### ProgrammingOptions.c

This example shows how to get, print out and change options settable in the [Device and Algorithm Parameters Editor](#) window. First, the program checks the device insertion into the programmer's socket by calling the [ACI\\_GetStatus\(&Status\)](#) function. Then, after detecting correct and reliable insertion of the device into the programmer's socket, the program reads the current set of options by using the [ACI\\_GetProgOption](#) function, and prints them out. Then it changes the Vpp value from the default to 10.5V and disables the device Brown-out Reset feature.

#### SaveMemory.c

This example shows how to save a binary image of the device in a file. First, the program checks the device insertion into the programmer's socket by calling the [ACI\\_GetStatus\(&Status\)](#) function. Then, after detecting correct and reliable insertion, the program reads data from a specified range of the SST89V564RD device's memory and saves them in the file test.bin.

#### Checksum.c

This example shows how to calculate a checksum of the data read out from a device. First, the program checks the device insertion into the programmer's socket by calling the [ACI\\_GetStatus\(&Status\)](#) function. After detecting correct and reliable insertion, the program figures out the real size of the SST89V564RD device's flash memory by executing the [ACI\\_ExecFunction](#) function. Then it assigns the buffer 'buf' in the host computer's memory in order to accommodate the data read out from the device,

moves the data to this buffer and calculates the checksum of the buffer's content.

## 4.7 Control from NI LabVIEW

The National Instruments' LabVIEW™ (hereafter LabVIEW) is a widely used and very popular graphical development environment that enables integration of many design, production and test tools. It is possible to drive ChipProg programmers from LabVIEW using such ChipProgUSB built-in tools as the [Command Line](#) or [ACI](#).

### 4.7.1 Command Line Control from LabVIEW

This is the simplest way to integrate LabVIEW with ChipProgUSB. In general the scenario includes: a) setting the programming session options within the ChipProg user interface and b) further operating with the programmer from the LabVIEW user interface. Here is an example of use:

1) Create a special folder for driving the ChipProgUSB software from the LabVIEW user interface - for example **C:\LabView\1**.

2) On the computer desktop, make a copy of the ChipProgUSB icon. Rename it for use exclusively for the LabVIEW control. Normally the path to this icon is "**C:\Program Files\ChipProgUSB\x\_xx\_xx\UprogNT2.exe**", where the '**x\_xx\_xx**' means a current version of the ChipProgUSB software. Right click on the created icon, select **Properties**, tab **Shortcut** and in the field **Start in** change the path to the **C:\LabView\1** (see below):

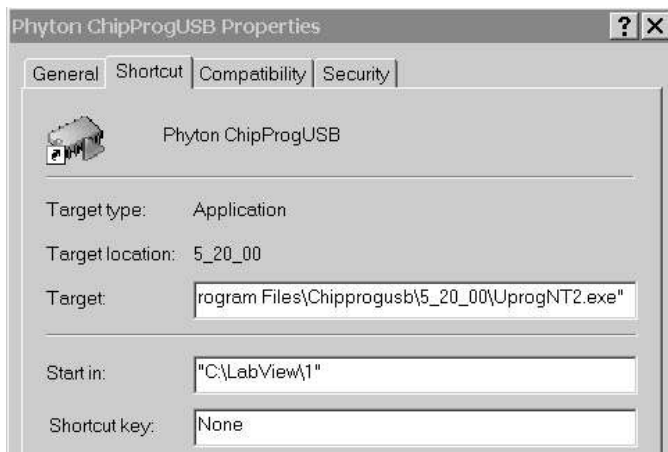

3) Power the ChipProg device programmer, connect it to a USB port of your PC and launch the ChipProgUSB program by clicking the icon in the folder **C:\LabView\1**. When the programmer's user interface opens, begin setting the programming session options by choosing the target device (for example by pressing the **F3** hot key). Then, after choosing the device, it is necessary to set up the programming options and parameters within the ChipProgUSB windows, menus and dialogs below if these options **differ from the default** ones. The following options are settable within the ChipProgUSB GUI:

- Settings in the [Program Manager](#) window ,such as selecting functions to be included into the **Auto**



**Programming** batch (button **Edit Auto...**); these include Split data, Insert test, Auto Detect and other settings in the [Options](#) tab; the number of chips to be programmed during the programming session and other options in the [Statistics](#) tab.

- Settings in the [Device and Algorithm Parameters Editor](#) window that are device-specific, such as boot vectors, fuses, lock bits, Vcc voltage, oscillator frequencies, etc.
- Settings in the sub dialogs accessible through the [Serialization, Checksum, Log file...](#) menu, such as setting algorithms for writing serial numbers and custom signatures into the devices being programmed, a buffer checksum calculation, programming custom shadow areas, dumping data to log files, etc.
- Miscellaneous settings in the sub dialogs accessible through the [Preferences](#) and [Environment](#) menus, such as color, fonts, sounds, etc.

Then complete the programming session by means of including an appropriate [command line keys](#) into the command line pattern:

- Specifying a method of control through the programming session (key **/S**);
- Choosing the target device being programmed (key **/C<manufacturer>^<device>**);
- Loading the file to be programmed and the file format (key **/L<file name> /F<file format>**);
- Specifying the [Auto Programming](#) mode (key **/A**);
- Launching the programmer into the hidden mode, when the ChipProgUSB GUI invisible (key **/I2**).

4) To launch a ChipProg in the command line mode use a standard LabVIEW module **SystemExec**. The picture below show a screen shot of the LabVIEW GUI front panel with the cp48\_01.vi module loaded:

**Notes:**

- The device specified in the command line by the key **/C** must be the same as chosen in the ChipProgUSB user interface.
- Including the **/I2** key in the command line makes the ChipProgUSB application main window invisible, suppresses display of error messages but copies them to the Windows clipboard. If the session completes successfully the ChipProgUSB application returns the error code 0; in case of errors, 1 is returned.

If, for example, you want to program a HEX file **myfw1020.hex** located in the folder **Program Files (x86)\ChipProgUSB\5\_21\_00** into the flash memory of a lot of **Texas Instruments CC2540F256** devices, then the command line should have the following format:

```
"C:\Program Files (x86)\ChipProgUSB\5_21_00\UprogNT2.exe" /L"Program Files (x86)\ChipProgUSB\5_21_00\myfw1020.hex" /FH /C"Texas Instruments^CC2540F256" /A /I2
```

4) To launch a ChipProg in the command line mode use the standard LabVIEW **SystemExec** module. The picture below shows a screen shot of the LabVIEW GUI front panel with the cp48\_01.vi module loaded:

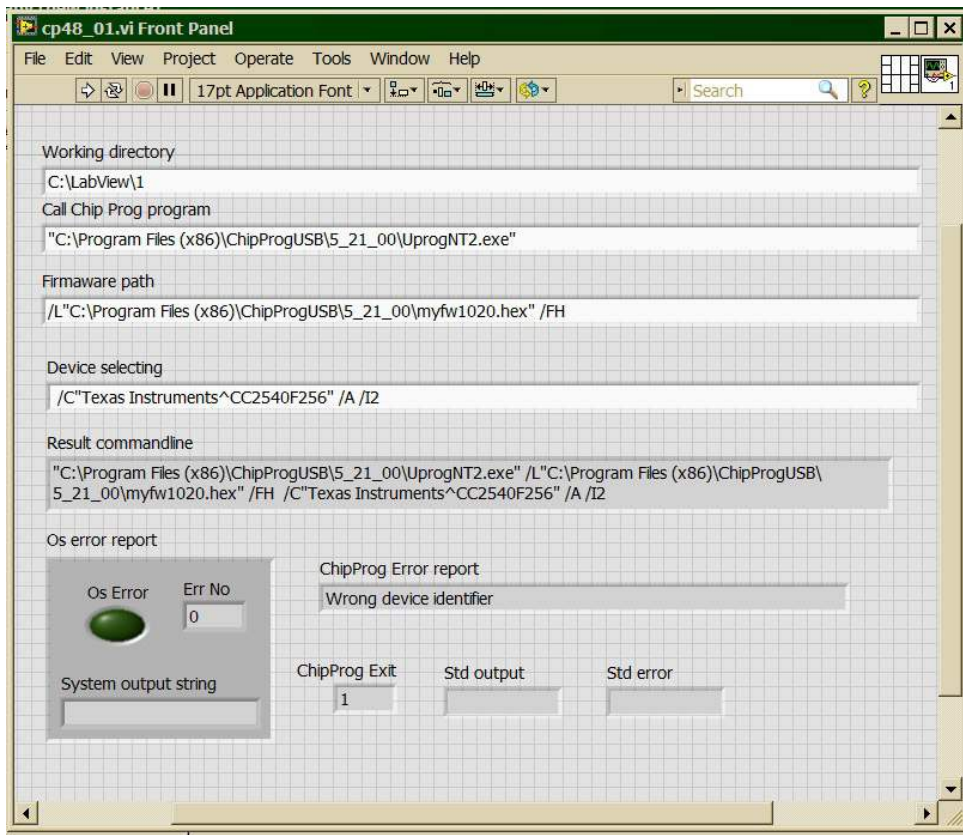

and below is the same module block diagram:

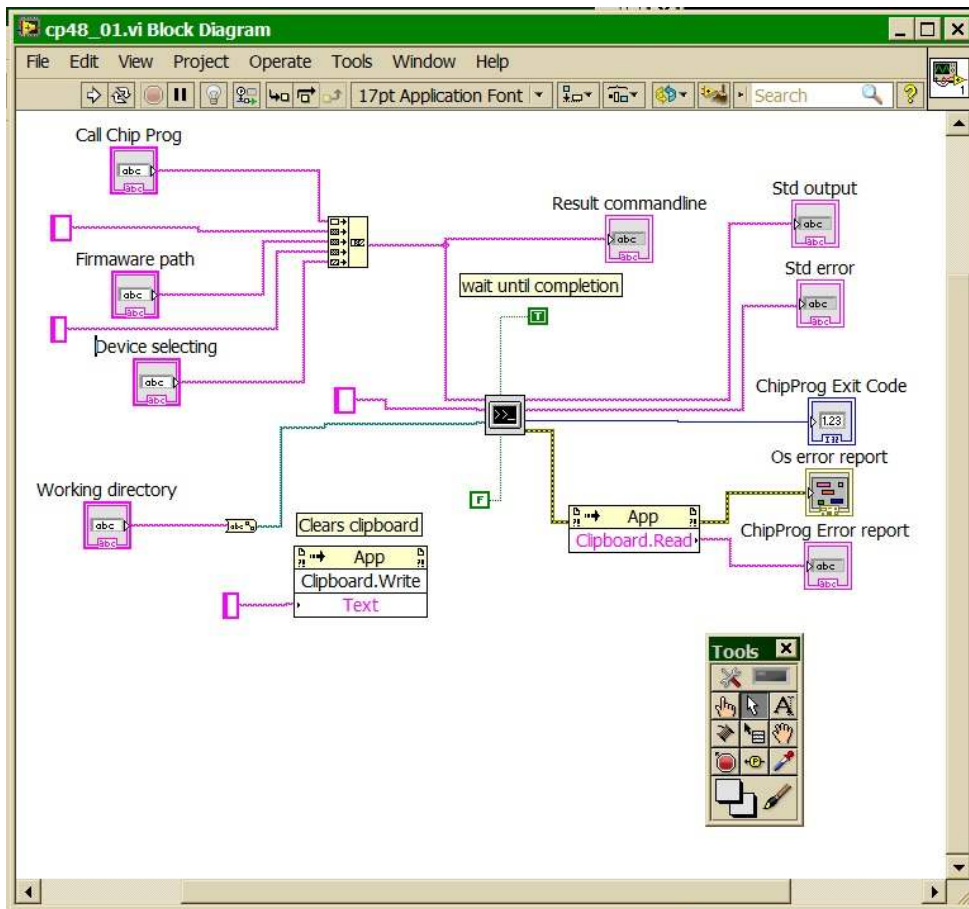

The <ChipProg launches in the hidden mode; its GUI remains invisible during the programming session. If no errors occur the **ChipProg Exit** box returns the code 0, otherwise 1 is returned. The error is displayed in the ChipProg Error box report.

#### 4.7.2 Control from LabVIEW with DLL

The ChipProgUSB software package includes the **Virtual Instruments** (VI) library developed in the National Instruments' LabVIEW™ graphical development environment. It also includes a few usage examples of these virtual instruments. The library files reside in the LabVIEW folder located in the ChipProgUSB installation directory. The library was created with the 2013 SP1 version of LabVIEW.

The DLL control is based on use of the Application Control Interface. Each VI is a wrapper over the appropriate function exported by the ACI.DLL software module. You should be quite familiar with the Application Control Interface functions and aspects of use in order to use the Virtual Instruments library.

Because of limitations imposed by LabVIEW on passing parameters to functions exported from DLLs, the virtual instruments do not call the ACI.DLL functions directly. Instead, they call functions exported from the intermediate DLL - the ACI\_LV.DLL. This DLL packs parameters into structures required by ACI.DLL and then calls its functions. The declarations of functions exported by ACI\_LV.DLL are placed in the C/C++ header file named ACIProgLabVIEW.h.

Each virtual instrument has its own front panel. It allows calling an appropriate Application Control Interface function. In order to do this, before launching this function, you should launch the ChipProg by means of the VI with the name ACI Launch. Each virtual instrument has input and output terminals for

inputting and outputting parameters of the ACI function served by the virtual instrument.

The VI folder includes a sub-folder Examples that contains two use examples for virtual instruments. The "Device Programming Example" demonstrates use of all major ACI functions, namely:

- launch a device programmer
- load a project
- display the device programmer buffer content in the GUI
- display a chosen device in the GUI
- display the device programmer socket's status (if a chosen programmer type supports this feature)
- write the serial number and increment it automatically in the device programmer buffer
- execute programming functions on the device and display the results in the GUI
- count numbers of successfully programmed and failed devices and display them in the GUI

To evaluate the example start up a ChipProg and launch the **Device Programming Example** by the **Run continuously** button in the LabVIEW GUI. Then click the **Launch Programmer** button on the VI's front panel. This will open a front panel of the virtual instrument **ACI Launch**. Enter a full path to the ChipProgUSB executable file, for example: "C:\Program Files\ChipProgUSB\6\_00\_00\UprogNT2.exe" and (optionally) specify the command line parameters. In order to avoid confirming the programmer restart, you can specify the path to the UprogNT2.exe in the constant string in the virtual instrument diagram and uncheck the **Prompt for programmer name, switches, etc...** box on the front panel (see the diagram below).

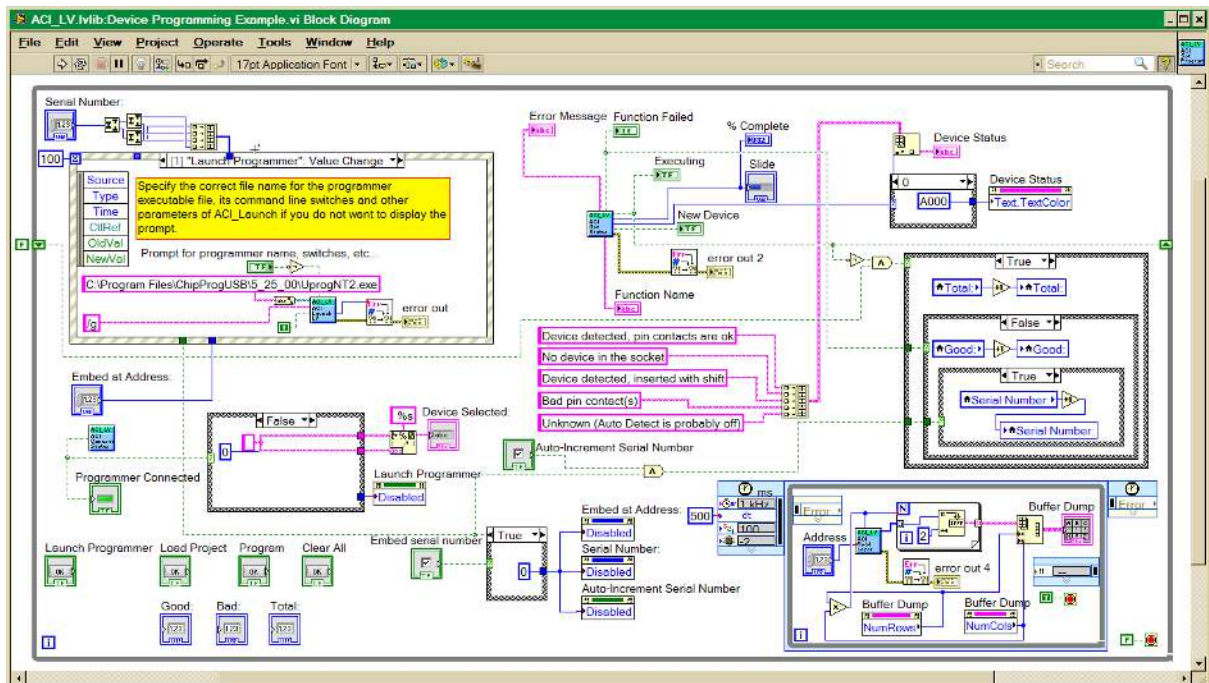

Then, after launching the programmer, its current status will become visible in the virtual instrument's front panel. Clicking the **Start** button launches the operation with the name that you can enter into the **Function Name** field, for example: **Blank Check**. If the **Function Name** field is left blank then the programmer will execute the **Auto Programming** function. See the pictures below:

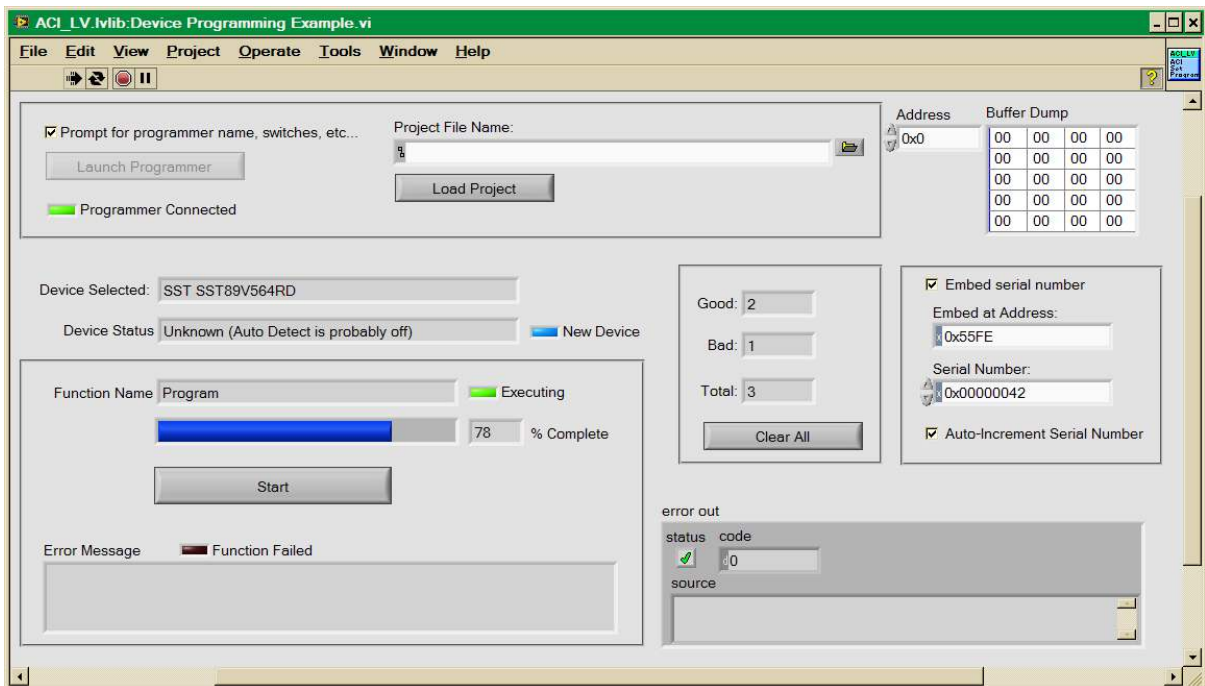
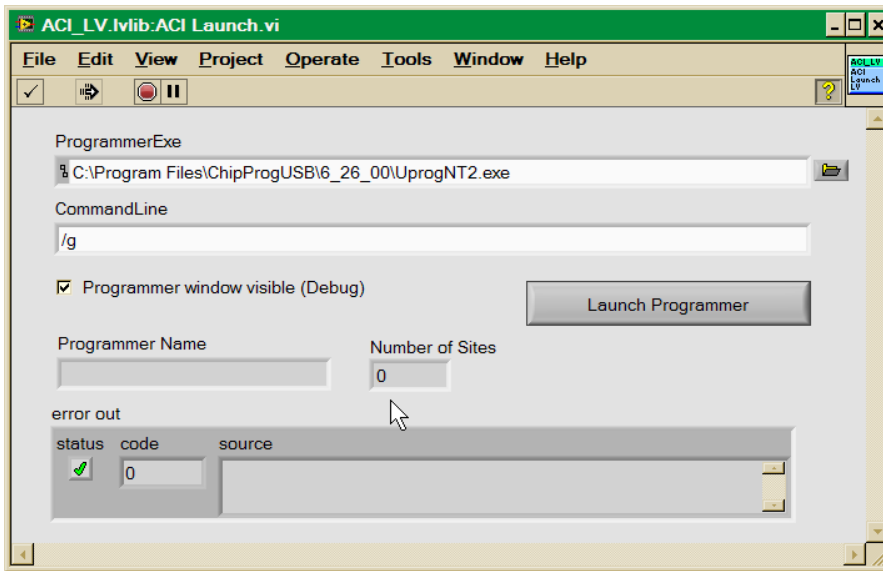

## 5 Operating with Programmers

The topics included in this chapter briefly describe basic operations with the ChipProg programmers.

### 5.1 Inserting devices to a programming socket

#### Inserting devices in DIP (dual-in-line) packages.

The ChipProg-40, ChipProg-48 and ChipProg-G41 programmers are equipped with 40- or 48-pin ZIF sockets allowing operating on any DIP-packed devices without additional adapters. They can accommodate DIP-packed devices with different number of leads (from 4 to 48) and different widths of the package up to 600 mil. Just a few old DIP-packed devices require special adapters to be programmed by ChipProgs. The [Device Information](#) window prompts if some adapter is required for the selected device and, if so, it displays the adapter type. The pictogram showing a correct insertion position of the device is on the programmer at the left of the socket as well as in the [Device Information](#) window. Practically all DIP-packed devices can be inserted in the way shown on the pictogram. However, there are a few old devices with a non-standard insertion positioning. If such a device is chosen the [Device Information](#) window displays how to insert the device.

#### Inserting devices in non-DIP packages.

Programming of the devices in SOIC, PLCC, QFP, BGA and other non-DIP packages requires special adapters. The adapters design allows plugging them into the programmer ZIF sockets. The [Device Information](#) window prompts the adapter type for a selected device.

Any adapter is implemented as a small transition board with two rows of dual-in-line pins pluggable into the programmer ZIF socket on a bottom side and a ZIF socket of a particular type (SOIC, PLCC, QFP, BGA, etc.) on a top. The adapter transition board is labeled with a "#1 pin" key mark that helps to properly position the adapter into the programmer socket. The [Device Information](#) window displays the adapter position into the programmer ZIF socket.

### 5.2 Auto-detecting the device

If you checked the **AutoDetect** checkbox on the main window toolbar then a ChipProg programmer will automatically detect insertion of the device into a programming socket and will check if the device's leads are reliably squeezed by the socket contacts. In case of the bad contact with any single lead the programmer blocks further operations and issues a warning that indicates the pin numbers with bad contacts. This prevents destroying the device or incorrect programming.

The **AutoDetect** signal can be used for triggering a programming operation by checking the **Auto-Detect presence of device in the socket** box in the [Options](#) tab of the [Program Manager](#) window. One of the following options can be set here:

- Execute the function selected in the 'Function' list (the [Program Manager](#) tab);
- [AutoProgramming](#);
- Execute script.

At this point the **AutoDetect** trigger replaces the programmer command executed by a mouse click or pressing the **Start** button. This significantly speeds up and simplifies programming of the device series.

## 5.3 Basic programming functions

Sub-topics of this chapter describe all the basic ChipProg-40 and ChipProg-48 operations in a **single programming mode**, when a device is programming in the programmer socket. Specific operations for programming more than one device at one time are described in the Multi- and Gang programming

### 5.3.1 How to check if a device is blank

1. Select the target device type, pressed the button **Select Device** in the Main toolbar or select the command **Main menu > Configure > Select device**.
2. [Insert a device](#) of the selected type into the programmer socket or into the adapter socket.
3.
  - a) Click the **Check** button on the main toolbar or
  - b) Double click on the **Blank check** function line in the **Function** list of the [Program Manager](#) window or
  - c) Select the **Blank check** function line in the **Function** list of the [Program Manager](#) window and click the **Execute** button or
  - d) Select the **Main** menu > **Commands** and click on the **Blank check** line

then wait for the message **Checking ... OK** in the [Program Manager](#) window, or for the warning message if the device is not blank

### 5.3.2 How to erase a device

1. Make sure the device is electrically erasable. Some devices are not erasable; these may be programmable once, UV erasable, or over-writable – in this case the **Erase** button is blocked (grey out).
2. If the device is electrically erasable:
  - a) Click the **Erase** button on the main toolbar or
  - b) Double click on the **Erase** function line in the **Function** list of the [Program Manager](#) window or
  - c) Select the **Erase** function line in the **Function** list of the [Program Manager](#) window and click the **Execute** button or
  - d) Select the **Main** menu > **Commands** and click on the **Erase** line

then wait for the message **Erasing ... OK** in the [Program Manager](#) window or for the warning message if the device is not blank after erasing.

### 5.3.3 How to program a device

In order to program a blank device you need to perform a few consecutive operations:

- [load the file](#), that you want to write to the device;
- [edit the file](#) (if necessary);
- [configure](#) the device to be programmed (if necessary);
- [write](#) the prepared information into the device and verify the programming.



#### 5.3.3.1 How to load a file into a buffer

1. Select the **Main menu > File > Load** or click the **Load** button on the local toolbar of the **Buffer** window.
2. In the pop-up dialog box enter the source file name, select the file format, addresses, [buffer](#) and sub-level to load the file to.
3. Wait for the message **File loaded: "....."** in the [Program Manager](#) window or for a warning message if the file cannot be loaded for some reason.

#### 5.3.3.2 How to edit information before programming

1. If you need to modify source data before writing into the target device, then open the [Buffer Dump](#) window. Never forget that the **View** button should be released to enable editing.
2. Make necessary changes in the window via the [Modify](#) dialog or appoint the data to be modified and type the new data over the old data.

#### 5.3.3.3 How to configure the chosen device

1. If any parameters displayed in the [Device and Algorithm Parameters](#) window can be changed by editing, their names are shown in blue.
2. Click on the name of the parameters to be changed to open an appropriate dialog. Set a new value for the parameter or check/uncheck appropriate boxes and click OK. The parameter value will change its color to red.
3. Continue for other parameters that should be changed. All preset changes will become effective in the target device only upon programming via the [Program Manager](#) programming function.

#### 5.3.3.4 How to write information into the device

1. Click the [Options](#) tab in the [Program Manager window](#). Check the options you need. We recommend that you always check the [Blank check](#) before programming and the [Verify](#) after programming check-boxes to make programming more reliable.
2. Click the [Program Manager tab](#). Select the **Program** line in the **Function box**, and double click it to start programming of the primary memory layer (**Code**) or click the **Execute** button to do so. Alternatively, you can do the same by clicking the big **Program** button or selecting the command **Menu > Commands > Program**.
3. Wait for the message **Programming ... OK** in the **Operation Progress box** of the [Program Manager tab](#). If an error has occurred the ChipProgUSB issues an error message.
4. Execution of the main **Program** function (always shown in the beginning of the **Function list**) writes a specified buffer layer content to the **Code** device memory. However, other buffer layers may exist for the selected device (**Data**, **User**, etc.). If more than one buffer layer exists for the selected device go down to the list of functions, expand those that are collapsed and execute the **Program** functions for as many types of memory as the device has (**Data**, **User**, etc.). Skip this if just one memory layer **Code** exists for the device.



5. **IMPORTANT!** After programming of all the memory layers (**Code, Data, User**, etc.) you need to program the options preset in the [Device and Algorithm Parameters Editor window](#), if they have been modified. Go down to the **Device parameters & ID** line, expand it if collapsed, select the **Program** function and double click it. Continue until every parameter that was changed in the **Device and Algorithm Parameters window** is successfully programmed.
6. Some microcontrollers can be protected against unauthorized reading of the written code by setting a set of **Lock bits**. Go down to the **Lock bits** line, expand it if collapsed and double click the lock bit# lines one by one. You can optionally lock only certain parts of the device memory. Continue until every lock bit is set.
7. After every operation above make sure that you watch the **Ok [xxxxx... Ok]** message in the **Operation Progress** box of the **Program Manager tab**. In case you get an error message stop the programming and troubleshoot the issue.

### 5.3.4 How to read a device

There are several ways for reading the device content to an active buffer:

- a) Click the **Read** button on the main toolbar or
- b) Double click on the **Read** function line in the **Function** list of the [Program Manager](#) window or
- c) Select the **Read** function line in the **Function** list of the [Program Manager](#) window and click the **Execute** button or
- d) Select the **Main** menu > **Commands** and click on the **Read** line

then wait for the message **Reading ... OK** in the [Program Manager](#) window or for the warning message if the device could not be read out.

### 5.3.5 How to verify programming

There are several ways for checking if the device was programmed correctly:

- a) Click the **Verify** button on the main toolbar or
- b) Double click on the **Verify** function line in the **Function** list of the [Program Manager](#) window or
- c) Select the **Verify** function line in the **Function** list of the [Program Manager](#) window and click the **Execute** button or
- d) Select the **Main** menu > **Commands** and click on the **Verify** line

then wait after that which wait for the message **Verifying ... OK** in the [Program Manager](#) window or for the warning message if the device failed during the verification process.

### 5.3.6 How to save data on a disc

1. After you have read out the device content into the [Buffer](#) or a specified [Buffer layer](#) you may need to save the read data on a PC disc. To save the data:
  - a) Click the **Save** button on the local toolbar of the **Buffer** window or
  - b) Select the **Main menu** > **File** > **Save**

2. In the pop-up dialog specify the destination file name, format, start and end addresses of the source (the buffer), and the source sub-level, and click OK.

### 5.3.7 How to duplicate a device

1. Insert the master device to be copied (duplicated) into the programmer socket.
2. [Read](#) it to an active buffer
3. Wait for the message **Reading... OK** in the **Operation Progress box** of the Program Manager tab in the [Program Manager](#) window. Make sure the master device content is in a current buffer.
4. Remove the master device from the socket and replace it with a blank device to be programmed. If necessary, [check](#) to see if it is blank.
5. [Program](#) the device. If you need to make more than one copy of the master device repeat the operations #4 and #5 as many times as necessary.

## 5.4 Programming NAND Flash memory

This chapter describes some peculiarities of the NAND Flash memory devices programming. The NAND Flash and NOR Flash memory architectures and physical implementations are very different and, therefore, operations with NOR and NAND Flash devices have their own peculiarities. In terms of the programmer setup and operations, working with the NAND Flash devices is more complex and the programming results are very sensitive to the accuracy of the programming options setup. Inaccurate setup causes wrong device programming.

### 5.4.1 NAND Flash memory architectures

The NAND Flash memory array comprises of the blocks of pages. Each block usually includes 16, 32, 64 and more pages. Conditionally, the NAND Flash devices can be divided in two groups: the "small page" and "large page" devices. The "small page" size is 512 bytes for the 8-bit devices and 256 bytes for the 16-bit devices; the "small page" NAND Flash memory devices' capacity varies from 128K to 512K bits. The picture below shows the "small page" NAND Flash memory architecture of the STMicroelectronics™ NAND devices.

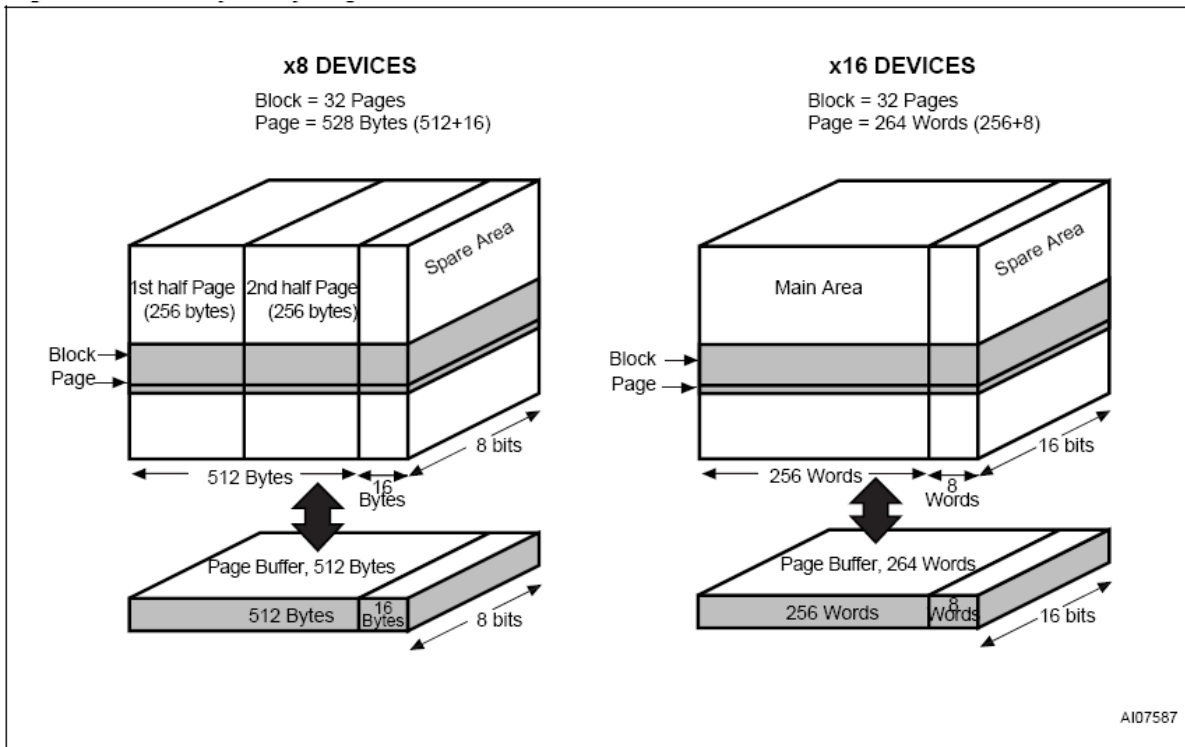

The "large page" size is 2048 bytes for the 8-bit devices and 1024 bytes for the 16-bit devices; the "large page" NAND Flash memory devices' capacity varies from 256K to 32G bit capacity and higher. The picture below shows the "large page" NAND Flash memory architecture of the STMicroelectronics™ NAND devices. The latest "large page" NAND Flash devices have as large as 4096 byte page size.

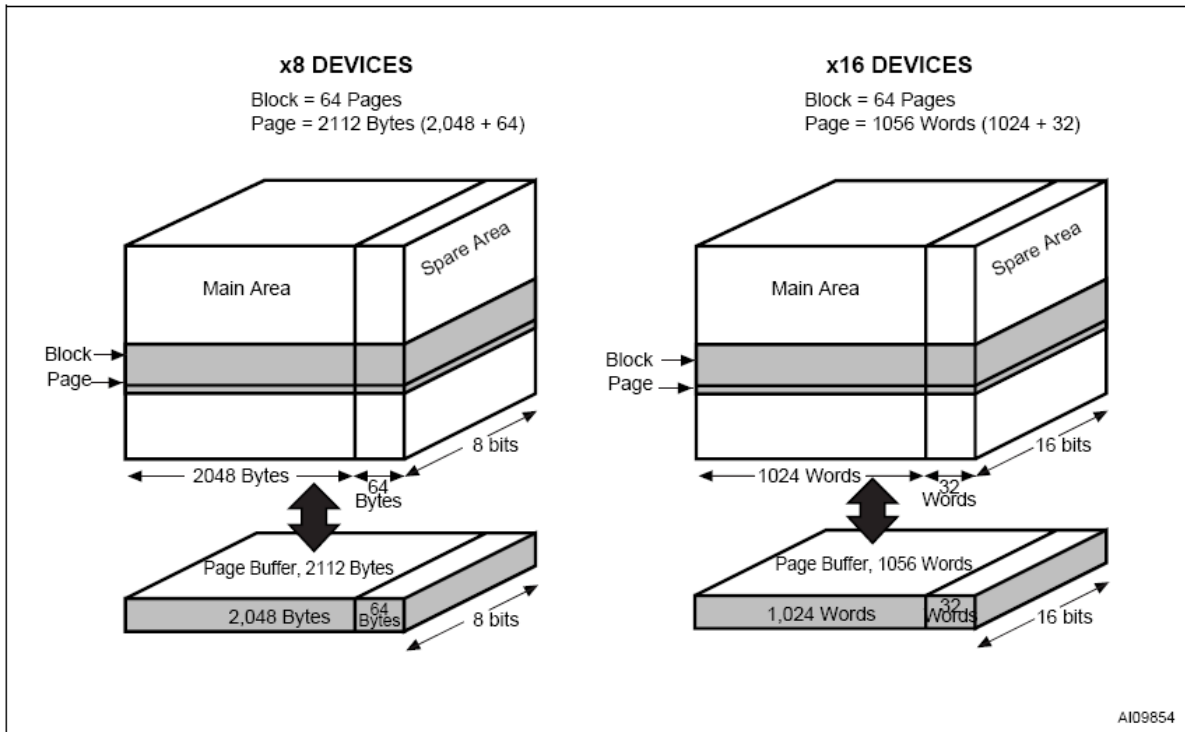

Read also about [bad blocks](#) in the NAND Flash memory devices.

#### 5.4.1.1 Invalid blocks

NAND Flash memory devices have invalid memory blocks that cannot be used for storing data because some memory cells inside of the device have physical defects - either inherent in a process of the device manufacturing or acquired in a process of the device exploitation and reprogramming in the user's equipment. Since a percentage of invalid blocks is pretty small inside of the chip (usually less than 1%) it is possible to use the device for data storing. In order to use NAND devices with bad blocks these blocks should be [marked](#) in a certain way to prevent fetching data from these blocks or writing in it. This document equally uses both known terms for such blocks: invalid and bad.

Locations of the invalid blocks or the invalid blocks map should be accessible by the application for skipping the bad blocks or handling them in other way. To keep the invalid block map every NAND Flash device has a special cell array, known as the **Spare Area**, for storing addresses of invalid blocks. See the **Spare Area** location in the [NAND Flash memory architecture](#) diagrams.

The Spare Area in "small page" 8-bit devices is 16 large, 16-bit devices - 8 Words. The Spare Area in "large page" devices - 64 Bytes and 32 Words respectfully. Though the Spare Area is dedicated for marking bad blocks it can be also used as a general purpose memory for storing the user's data. To avoid accidental losing of the bad block map it is recommended to assign a whole entire Spare Area for storing the invalid block map and do not write in this area anything else.

##### 5.4.1.1.1 Managing invalid blocks

There are three mostly used methods of handling invalid memory blocks:

[Skip Block method](#)  
[Reserved Block Area method](#)  
[Error Checking and Correction](#)

The ChipProg programmers support all the methods above.

##### 5.4.1.1.1.1 Skipping invalid blocks

This is the simplest method of managing invalid blocks. The programming algorithm first reads the entire [Spare Area](#) to collect the addresses of invalid memory blocks. Then, the programming equipment writes data to the device page by page with checking the block addresses. If the current block's number is marked as bad the programmer skips this block and write into the next valid one.

##### 5.4.1.1.1.2 Reserved Block Area

This method is based on the idea of replacing invalid blocks with good blocks by re-directing reading and writing operations to these good blocks. To implement this method the programming equipment splits the entire memory in three linear memory areas following each other from the start address of the memory device. Each of these areas may include both good and bad blocks:

- The **User Block Area** (UBA) - a linear memory array for storing the user's data;

- The **Block Reservoir** - a linear memory array that follows right after the User Block Area; good blocks from the Block Reservoir replaces invalid blocks from the User Block Area;
- The **Reserved Block Area (RBA)** - this part of the device's memory stores the information about bad blocks in the User Block Area replaced by good blocks from the Block Reservoir. This map is represented by pair of addresses of the invalid UBA's blocks and corresponding good blocks from the data reservoir. The first good block in the RBA stores the the RBA map table, the second a duplicate of it in case of the RBA table corruption.

The programming algorithm works in the following way:

- 1) it splits blocks of the device in three areas: **User Block Area**, **Block Reservoir** and **Reserved Block Area**;
- 2) it reads the [Spare Area](#) and builds the RBA map table with the following structure of the data fields:

Field:	RBA Marker	<u>Count Field</u>	Invalid Block	Replaced Block	Invalid Block	Replaced Block	.....	Invalid Block	Replaced Block
Size:	2 байт a	2 байт a	2 байта	2 байта	2 байта	2 байта	.....	2 байта	2 байта

where:

**RBA Marker** - is 0FDFEh (there is an equivalent term for this parameter used in some NAND Flash device data sheets: **Transition Field**).

**Count Field** - starts from 1 and increments by one for each page of the map table.

**Invalid Block** - Number of the invalid block in the UBA being replaced.

**Replaced Block** - Number of the valid block in the Block Reservoir that replaces the invalid block above.

The **Invalid Block - Replaced Block** pairs follow each other till the page break.

When the programming equipment detects an invalid block in the User Block Area it appoints the first available valid block in the Block Reservoir and updates the RBA table to keep track of relation between invalid blocks in the User Block Area and replaced good ones in the Block Reservoir.

#### 5.4.1.1.1.3 Error Checking and Correction

To maintain the stored code integrity it is recommended to use known **Error Checking and Correction** (ECC) algorithms. Most NAND Flash device manufacturers publish application notes that describe the ECC algorithms suitable for using their devices in different applications. To implement a particular ECC algorithm please check the manufacturer's website. All the ECC-related information are written into the [Spare Area](#).

#### 5.4.1.1.2 Invalid block map

ChipProg programmers create the [invalid block](#) map into the buffer layer **Invalid Block Map** as a continues bit array. Valid (good) blocks are represented by zeros (0), invalid (bad) - by ones (1). See the tab **Invalid Block Map** in the memory buffer:

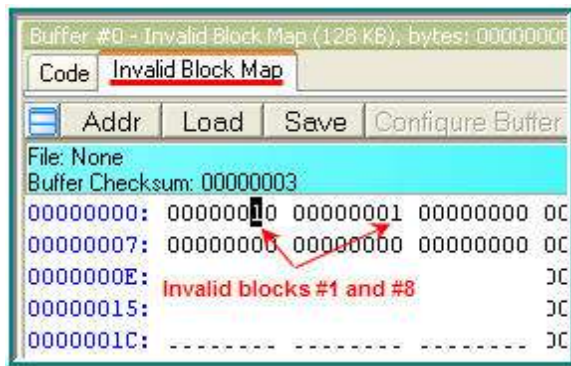

For example above:

- the value 02h (or 0000010B) at the address 0 means that the blocks #0, 2, 3, 4, 5, 6, 7 are valid while the block #1 is invalid;
- the value 01h (or 0000001B) at the address 1 means that all the blocks in the range #9 to #15 are valid while the block #8 is invalid.

#### 5.4.1.2 Marking invalid blocks

After the device final testing the device manufacturer' programming equipment fills the working memory cells with the FFh value. Blocks that are considered to be invalid are marked by writing a non FFh value (usually 00h) at a certain address in first page (page #0). This address in the NAND Flash [Spare Area](#) is the device dependant; it is specified in the manufacturer data sheet.

Memory organization	The marker address in the Spare Area
8-bit array, page size - 512 Byte.	5
16-bit (word) array, page size - 512 Words.	0
8-bit array, page size - 2048 Byte.	0 or 5
16-bit (word) array, page size - 1024 Words	0

Take in account that the device itself has no special protection against occasional erasing of the Spare Area cells when you intentionally erase a whole memory array. However, these Spare Area cells may store the bad blocks markers written either by the chip manufacturer or by the chip user after reprogramming. Being lost the bad block map cannot be restored unless you keep the invalid block map as a file, etc. It is important to keep track of the invalid block map changes by storing the markers before the memory erasing and restoring them after the chip erasing. The ChipProg programmers automatically restore the invalid block map unless the [Invalid Block Management](#) is not the **Do Not Use**.

The ChipProg creates the [invalid block map](#) into the buffer layer **Invalid Block Map** as a continues bit array. Valid (good) blocks are represented by zeros (0), invalid (bad) - by ones (1). For example:

the value 02h at the address 0 means that the blocks #0, 2, 3, 4, 5, 6, 7 are valid while the block #1 is invalid;

the value 01h at the address 1 means that all the blocks in the range #9 to #15 are valid while the

block #8 is invalid.

### 5.4.2 Programming NAND Flash devices by ChipProg

Programming NAND Flash memory devices by a Phytion ChipProg programmer begins from accurate setting of the programming options and parameters in the [Device and Algorithm Parameters](#) window. The screen capture below shows the window for the NAND04GW3B2BN device. The **Device Parameters** are divided in two setting groups: [Access Mode](#) and [Access Mode Parameters](#).

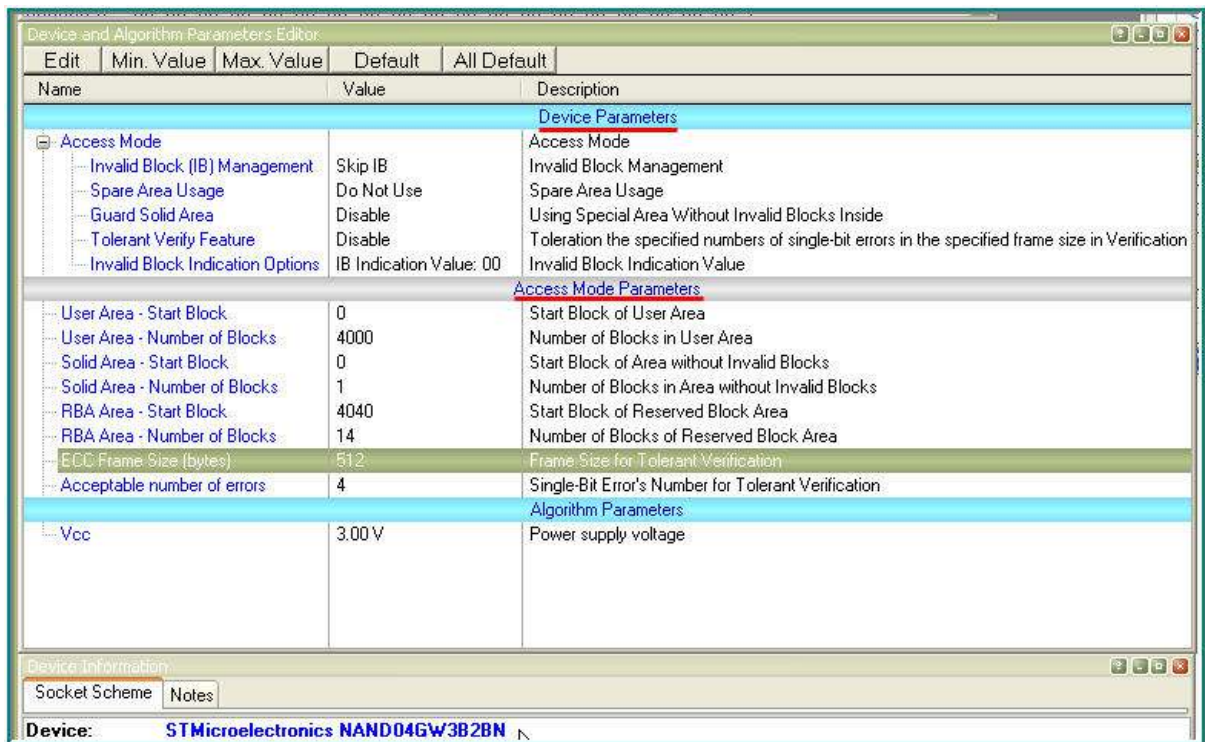

**IMPORTANT NOTE!**

Any changes made in the 'Device and Algorithm Parameters' window do not *immediately* cause corresponding changes in the target device. Parameter settings made within this window just prepare a configuration of the device to be programmed. Physically, the programmer makes all these changes only upon executing an appropriate command from the 'Program Manager' window.

### 5.4.2.1 Access Mode

The **Access Mode** line, normally collapsed, can be expanded to invoke setting dialogs for one of the following modes:

[Invalid Block Management](#)  
[Spare Area Usage](#)  
[Guard Solid Area](#)  
[Tolerant Verify Feature](#)  
[Invalid Block Indication Option](#)

#### 5.4.2.1.1 Invalid Block Management

Here you can specify the algorithm of managing invalid blocks. Clicking the **Invalid Block Management** menu line opens the pop-up dialog:



Select one of four options:

<b>Do Not Use</b>	Ignore information about invalid blocks and do not care of the invalid block management. Writing into invalid blocks is enabled.
<b>Skip IB</b>	<a href="#">Skip invalid blocks</a>
<b>Skip IB with Map in 0-th Block</b>	<a href="#">Skip invalid blocks</a> , put the <a href="#">Invalid block map</a> in the block #0.
<b>RBA (Reserved Block Area)</b>	Use the <a href="#">RBA</a> algorithm

#### 5.4.2.1.2 Spare Area Usage

Here you can specify of how to use the [Spare Area](#). Clicking the **Spare Area Usage** menu line opens the pop-up dialog:





Select one of three options:

<b>Do Not Use</b>	This default option means: "in no case do not use Spare Area for storing user's data". Choosing this default option prevents overwriting invalid block markers in the Spare Area by the user's data. After erasing the device Flash memory markers of the invalid blocks will be restored in the Spare Area.
<b>User Data</b>	The Spare Area can be used for storing the user's data; the invalid block markers written into the Spare Area <b>will not be protected</b> against overwriting by user's data. If this option is chosen the programmer writes the data from its <a href="#">buffer</a> into the major device memory and when this memory is completely full the programmer begins writing into the Spare Area. The programmer buffer displays merged memory pages, including the Spare Area.
<b>User Data with IB Info Forced</b>	The Spare Area can be used for storing the user's data but the invalid block markers written into the Spare Area <b>will be protected</b> against overwriting by user's data. Even if the programmer had overwritten the invalid block markers in the Spare Area it will restore these markers after completion of the programming operation.

5.4.2.1.3 Guard Solid Area

Some applications require fetching the information with strictly linear address range, e.g. the memory must be free of invalid blocks in this range. In particular, initialization of a microcontroller is possible only if the loading code is fetching from the memory device with continuously linear address space, so the source memory must not have invalid blocks. By default the ChipProgUSB disables guarding the memory area. Clicking the **Guard Solid Area** menu line opens the pop-up dialog where you can toggle the options:



When you select Enable in the dialog above you should specify this area by setting two parameters in the [Solid Area setting dialog](#):

- Start Block** - the address of the first memory block that does not include invalid blocks
- Number of Blocks** - the number of valid blocks in the specified memory area

If in a process of the programming verification the ChipProg locates an invalid block within the specified **Solid Area** it will issue an error message and stop the current programming operation.

#### 5.4.2.1.4 Tolerant Verify Feature

Here you can enable working with the memory having a certain number of errors within a specified memory range or disable this feature. By default it is disabled. Clicking the **Tolerant Verify Feature** menu line opens the pop-up dialog where you can toggle the options:



Usually this option is applicable in case of use the [Error Checking and Correction](#) (ECC) method of managing invalid blocks when you can tolerate with some errors in the data fetched from the memory device. When you select **Enable** in the dialog above you should specify two parameters in the [Acceptable number of errors](#) dialog:

**ECC Frame size (Bytes)** - Size of the memory array where you allow to have errors, in Bytes.  
**Acceptable number of errors** - Acceptable number of single bit errors.

#### 5.4.2.1.5 Invalid Block Indication Option

Here you can choose the invalid block presentation in the ChipProgUSB memory buffer. Clicking the **Invalid Block Indication Options** menu line opens the pop-up dialog where you can select either the '00h' value (default) or the '0F0h':



#### 5.4.2.2 Access Mode Parameters

This **Access Mode Parameters** submenu of the **Device Parameters** menu allows to invoke setting dialogs for the following parameters:

[User Area](#)  
[Solid Area](#)  
[RBA Area](#)  
[ECC Frame size](#)  
[Acceptable number of errors](#)

Some of the parameters above are associated with appropriate [Access Modes](#).

5.4.2.2.1 User Area

Some basis programming operations, including **Program**, **Read**, and **Verify** can be set applicable not to an entire NAND Flash memory device but to a specified part of the device memory - the **User Area**. The **Erase** and **Blank Check** operations are applicable only to the entire device. The **User Area's** boundaries are set by individual setting of a pair of the following parameters:

- User Area - Start Block** - the first memory block of the User Area.
- User Area - Number of Blocks** - the number of blocks in the User Area.

To set the **User Area** first click the **User Area - Start Block** submenu line. The setting dialog will pop up:

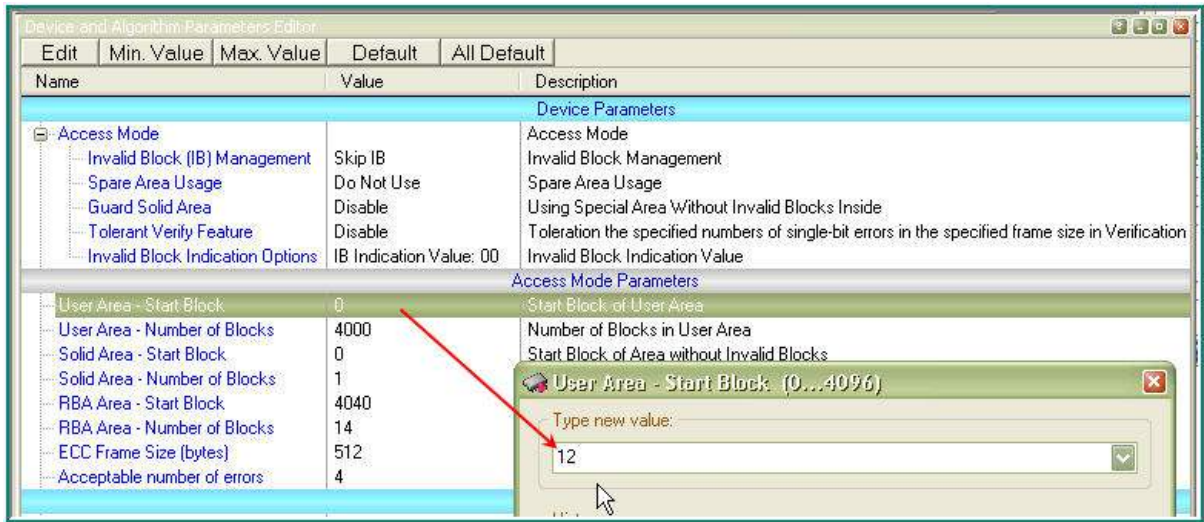

Type the value and click OK. Then click the **User Area - Number of Blocks** submenu line and enter the number of blocks into the pop-up dialog; then click OK to complete the **User Area** settings.

5.4.2.2.2 Solid Area

The **Solid Area's** boundaries are set by individual setting a pair of the following parameters:

- Solid Area - Start Block** - the first memory block of the memory area free of invalid blocks.
- Solid Area - Number of Blocks** - the number of blocks in the Solid Area.

To set the **Solid Area** first click the **Solid Area - Start Block** submenu line. The setting dialog will pop up:

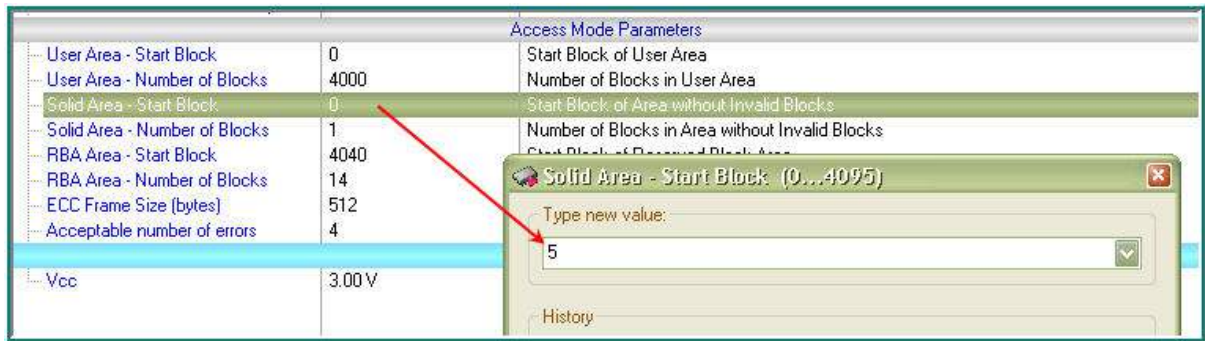

Type the value and click OK. Then click the **Solid Area - Number of Blocks** submenu line and enter the number of blocks into the pop-up dialog; then click OK to complete the **Solid Area** settings.

#### 5.4.2.2.3 Reserved Block Area

The **Reserved Block Area** (RBA) boundaries are set by individual setting a pair of the following parameters:

**RBA Area - Start Block** - the first memory block of the RBA.

**RBA Area - Number of Blocks** - the number of blocks in the RBA.

To set the RBA first click the **RBA - Start Block** submenu line. The setting dialog will pop up:

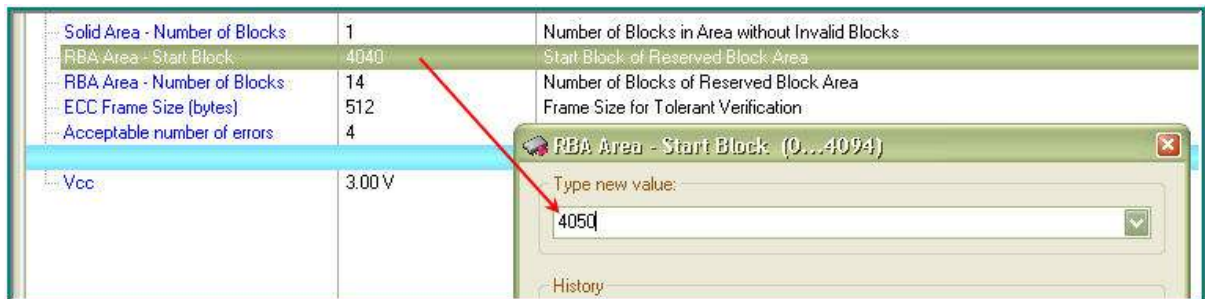

Type the offset value and click OK. Then click the **RBA Area - Number of Blocks** submenu line and enter the number of blocks into the pop-up dialog; then click OK to complete the **RBA** settings.

#### 5.4.2.2.4 ECC Frame size

This parameter of the **Tolerant Verify Feature** mode defines a size of the memory array where you allow to have errors. To set a parameter click the **ECC Frame size** submenu line. Then specify the parameter in bytes and click OK to complete the setting.

#### 5.4.2.2.5 Acceptable number of errors

This parameter, associated with the **Tolerant Verify Feature** mode, defines an acceptable number of single bit errors in the the memory array defined by the **ECC frame size**. To set the parameter click the **Acceptable number of errors** submenu line. Then enter the number and click OK to complete the setting.

## 5.5 Multi- and Gang-programming

**NOTE:** All the statements below refer only to the ChipProg device programmer control via the ChipProgUSB user interface and not in the remote mode via the [Application Control Interface](#).

ChipProg programmers can be launched in two **programming modes**:

- **Single-programming** mode, than means programming one device at a time by means of one ChipProg programmer.
- **Multi-programming** or **Gang-programming** mode that means concurrent programming of multiple devices at a time by:
  - either a multiple single site programmers of one type connected in one programming cluster driven from one computer;
  - or a special 4-site ChipProg-G41 gang programmer.

The **Multi-programming** mode differs from the **Single-programming** mode in the following items:

1. Only the same type of programmers can be used in this mode - either ChipProg-40 or ChipProg-48 or ChipProg-481 or ChipProg-ISP programmers;
2. Only the same type of the device may be selected for every single programmer connected in one programming cluster;
3. Only the same set of buffers can be opened for every single programmer connected in one programming cluster;
4. Only the [AutoProgramming](#) function can be executed by the ChipProgUSB in this mode. There is however one exception - ChipProg-G41 gang programmers can be combined with ChipProg-481 tools;
5. The [Program Manager](#) tabs and dialogs are very different.

The **Multi-programming** mode is intended for small- and middle-volume manufacturing. The programmers in the **Multi-programming** mode work concurrently, e.g. you can start programming on one site, insert a new device into a second socket, start the programming, insert a new device into a third socket, start the programming, remove the first programmed device, etc.. An ability to linearly increase the programming system productivity by adding a new ChipProg programmer gives you flexibility and save money.

In terms of the control there is no difference whether the ChipProgUSB controls a ChipProg-G41 gang programmer or the program drives a cluster of multiple single ChipProg-40 or ChipProg-48 or ChipProg-ISP programmers connected to one PC. To launch ChipProgUSB program in the **Multi-programming** mode it should be invoked either by using the **ChipProgUSB-GANG** shortcut in the ChipProgUSB folder or from the [command line](#) with the key **/GANG**.

The first dialog that appears when you started the **ChipProgUSB-GANG** shortcut (for the case when only two programmers forms a two-site programming cluster):

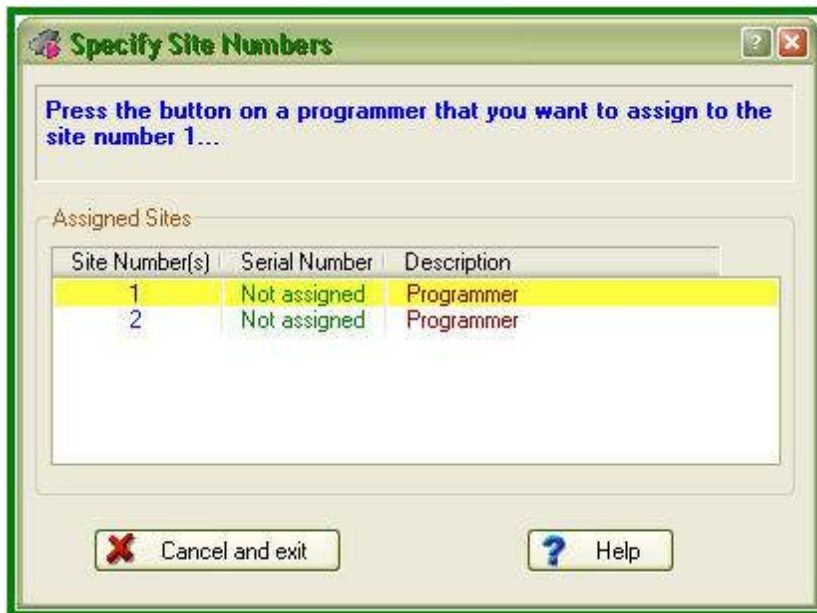

Now you should press the **Start** button on the programmer to which you would like to assign the site #1. Then the ChipProgUSB will prompt to assign the site #2 to another programmer (in case there are more than two programmers in the programming cluster), etc. After assigning numbers to the programmers you will get the [Program Manager](#) window that differs from the same window that you get when you work with one programmer.

### 5.5.1 The Program Manager Window

The **Program Manager** window is the major control object on the screen from which an operator controls the ChipProg . While some windows can be closed in a process of programming this one is supposed to be always open and visible. The window appearance differs from the same [Program Manager](#) window that you get when you work with one programmer.

The window includes three tabs, opening three groups of settings and status indicators:

[The Project Manager](#) tab

[The Options](#) tab

[The Statistics](#) tab

The **Project Manager** and **Options** tabs look differently and enable different settings for the ChipProg programmers working in the single-programming and multi-programming modes. These tabs are identical for the ChipProg-G41 gang programmer and for the ChipProg-481, ChipProg-48, ChipProg-40 and ChipProg-ISP programmers when they are configured to work in the multi-programming mode.

### 5.5.1.1 The Program Manager tab

Since the only **AutoProgramming** is available in the **multi-programming** mode this tab serves for manual **AutoProgramming** initiation, displaying the site [statistics](#) and information messages generated by the ChipProgUSB program.

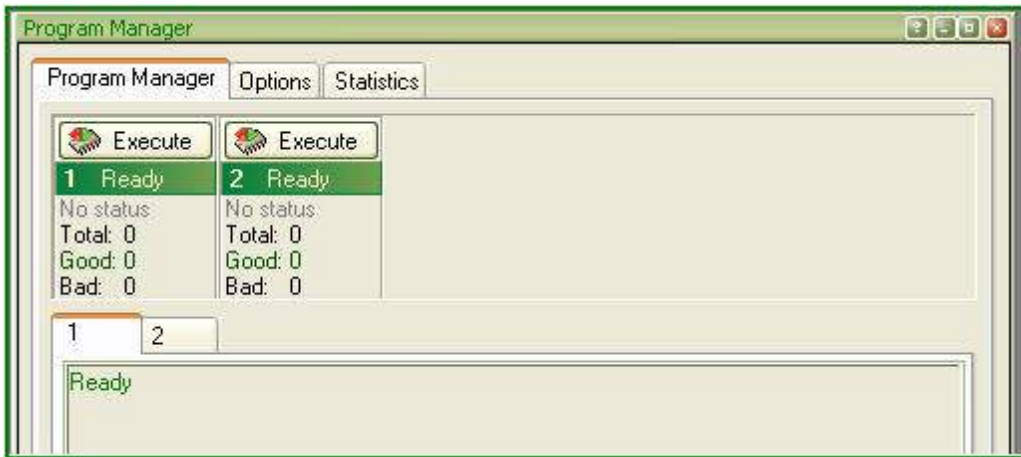

### 5.5.1.2 The Options tab

The tab serves for setting all programming parameters and options for **multi-programming** mode.

Element of dialog	Description
<b>Buffer:</b>	The field <b>Buffer</b> displays the active buffer to which the programming operations (functions) will be applied. A full list of open buffers is available here via the drop-down menu.
<b>Addresses</b>	Here you can set the addresses for the buffer and the target device to which the programming functions will be applied.
<b>Device start:</b>	The very first address in the target device's physical memory which will be programmed.
<b>Device end:</b>	The very last address in the target device's physical memory which will be programmed.
<b>Buffer start:</b>	The very first address in the buffer memory from which the data will be written to the target device.
<a href="#">Split Data</a>	The group of radio buttons in the <b>Split data</b> field allows to program 8-bit memory devices to be used in the microprocessor systems with the 16- and 32-bit address and data buses. To do this the buffer content should be properly prepared to split one memory file into

	several smaller files.
<b>Options:</b>	
<b>Device-Auto-Detect</b>	If this box is checked then <b>AutoProgramming</b> will start immediately after the ChipProg programmer has detected that the device is in the programming socket.
<b>Check device ID</b>	By default this option is always on and the ChipProg always verifies the target device identifier given by the device manufacturer. If the box is unchecked the program will skip the device ID checking.
<b>Insert test</b>	If this box is checked the ChipProgUSB will test whether each of the device leads is reliably squeezed by the programming socket contact. If some contact is bad a current operation will be blocked.
<b>Reverse bytes order</b>	If this box is checked the ChipProgUSB will sweep the byte order in the 16-bit word while it executes the <b>Read</b> , <b>Program</b> and <b>Verify</b> operations. This option does not affect the data in the ChipProg buffers, they remain the same after the file loading.
<b>Blank check before program</b>	If this box is checked the ChipProgUSB will always check if the target device is blank before programming it.
<b>Verify after program</b>	If this box is checked the ChipProgUSB will always verify the device content right after it has been programmed.
<b>Verify after read</b>	If this box is checked the ChipProgUSB will always verify the device content right after it has been read out.

### 5.5.1.3 The Statistics tab

This tab opens the field displaying the programming session statistical results for each programming site - **Total** number of devices that were programmed during the session, what was the yield (**Good**) and how many devices have failed (**Bad**).



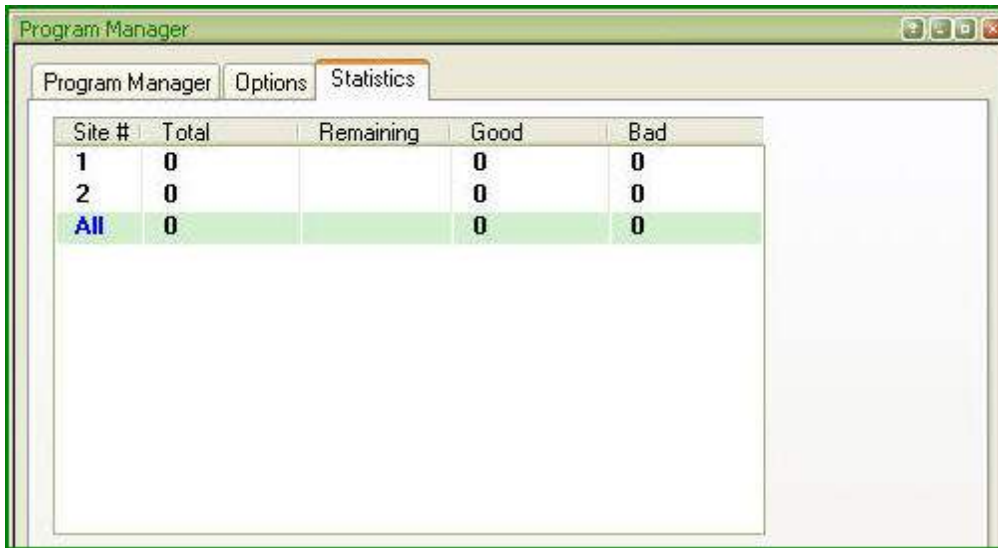

Element of dialog	Description
<b>Clear statistics</b>	This button resets the statistics..
<b>Device Programming Countdown</b>	Normally the <b>Total</b> counter increments after each <a href="#">Auto Programming</a> ; the, <b>Good</b> and <b>Bad</b> counters also count up. The ChipProgUSB reverses the counters to decrement their content (to count down).
<b>Enable countdown</b>	If the box is checked the ChipProgUSB will count the number of the programmed devices down.
<b>Display message when countdown value reaches zero</b>	If the box is checked the ChipProgUSB will issue a warning when the counter <b>Total</b> is zeroed.
<b>Reset counters when countdown value reaches zero</b>	If the box is checked the ChipProgUSB will reset all the counters when the counter <b>Total</b> is zeroed.
<b>Count only successfully programmed devices</b>	If the box is checked the ChipProgUSB will count only the successfully programmed ( <b>Good</b> ). All other statistics will be ignored.
<b>Set initial countdown value</b>	Clicking on the button opens the box for entering a new <b>Total</b> number that then will be decremented after each <a href="#">Auto Programming</a> .

## 5.6 In-System Programming

The ChipProg programmers generate all the signals necessary for programming devices installed in the user's equipment (in-system). In order to program devices in-system the programmers connect to the target via special adapters. When a device to be programmed is chosen, the ChipProgUSB software displays a part number of the appropriate **cable-adapter** in the [Device Information](#) window. The adapters.chm file includes wiring diagrams for all **cable-adapters**, that allows use of the adapters made by customers themselves.

### General requirements for connecting ChipProg programmers to the target system

<b>Connections</b>	<ol style="list-style-type: none"> <li>1. Connections must be done in accordance to the adapter's wiring diagram published in the adapters.chm file.</li> <li>2. The target system should not shunt or overload the logical signals generated by the programmer.</li> <li>3. Some IPS algorithms require generating logical signals with the voltage levels of 10 to 15V exceeding normal voltages used in electronic systems (3 to 5V). The target system should be tolerant to applying such "high voltages".</li> </ol>
<b>Powering</b>	<p>There are two alternative options for powering the targets:</p> <ol style="list-style-type: none"> <li>1. <b>The target gets power from the ChipProg.</b> This is possible only if the target does not consume too much energy. The current supplied from the programmer may not exceed 80 mA, a capacity of the target power circuitry should not exceed 50 uF.</li> <li>2. <b>The target gets power from a built-in or external power supply.</b> In this case the power output from the ChipProg should not be connected with the target. The target system should be tolerant to applying logical signals with the voltage levels exceeding the voltages on the target.</li> </ol> <p><b>NOTE!</b> It is strictly prohibited to power the target from both the programmer and built-in or external power supply simultaneously.</p>
<b>Electrical characteristics of the ChipProg signals</b>	<p>Max current load for the logical signals - 5 mA.</p> <p>Max current load for the Vcc line - 80 mA.</p> <p>Max current load for the Vpp line - 80 mA.</p>

**NOTE!** Always carefully check connecting your ChipProg programmer to the target. Wrong connecting may, and probably will cause destruction of the programmer's and/or the target system's hardware.

Most embedded microcontrollers have different algorithms for the ISP procedure. See the following topics regarding the ISP for popular microcontrollers:

[Specifics of the in-system programming of the Microchip PICmicro](#)

[Specifics of the in-system programming of the Atmel AVR microcontrollers](#)

[Specifics of the in-system programming of the Atmel 8051 microcontrollers](#)

## 6 References

### 6.1 Errors Messages

#### 6.1.1 Error Load/ Save File

5005 "Error reading file"

5004 "CRC mismatch, loading terminated"

5003 "Invalid .HEX file format"

5043 "Address out of range"

5078 "End address should be greater than start address"

5151 "Invalid file format"

5007 "Error writing file"

6899 "Cannot load file '%s': buffer #%u does not exist"

6900 "Cannot load file '%s': sub-level #%u does not exist"

7019 "Unable to open project file: '%s'.\n\nAfter start, the programmer attempts to load the most recent project. This error means that the project file does not exist on disk."

#### 6.1.2 Error Addresses

5189 "Device start address (0x%LX) is too large.\n\nMax. address is 0x%LX."

5190 "Device end address (0x%LX) is too large.\n\nMax. address is 0x%LX."

5191 "Buffer start address is too large"

4024 "Address %s is out of range (%s...%s)"

- 4106 "File format does not allow addresses larger than 0xFFFFFFFF"
- 4019 "Address in device: 0x%08X, Address in buffer: 0x%08X\n"
- 6626 "Buffer start address must be even"
- 6627 "Device start address must be even"
- 6628 "Buffer end address must be odd"
- 8002 "Buffer named '%s' already exists. Please choose another name for the buffer."

### 6.1.3 Error sizes

- 6372 "Buffer size is too small for selected split data option"
- 6495 "Requested buffer size (%lu) is too large"
- 6441 "Size of file is greater than buffer size:\nAddr = %08lX, length = %u"
- 6431 "Source block does not fit into destination sub-level"
- 6859 "File size is %u bytes that is less than header size (%u bytes), loading terminated. Probably, you have specified an invalid file format."
- 4107 "Cannot allocate %Lu MBytes for the buffer, maximal buffer size is %Lu MBytes"
- 5192 "Invalid number: '%s'"

.

### 6.1.4 Error command-line option

- 5329 "%s command-line option: Device name required"
- 5330 "%s command-line option: Missing file name"
- 5331 "%s command-line option: Missing file format tag"
- 5332 "%s command-line option: Invalid file format tag"
- 5333 "Command line: unable to determine the file format"
- 5334 "%s command-line option: Invalid address value"
- 4104 "Command-line option /l ignored because /A option is not specified"

### 6.1.5 Error Programming option

- 6409 "Invalid programming function or menu name:\n%s"
- 6410 "Invalid programming option name '%s'"
- 6902 "Invalid '%s' programming option value string: '%s'"

- 6411 "Programming option '%s' cannot be changed"
- 6412 "Programming option string is too long.\nMax. length is %u."
- 6854 "Programming option '%s' has type of '%s'. Use '%s()' script function to get the value of this option."
- 5188 "Value %.2f is out of range of %.2f...%.2f for programming option '%s'"
- 6561 "Value %ld is out of range of %ld...%ld for programming option '%s'"
- 4001 "Not all of the saved auto-programming functions were restored. Check the auto-programming functions list."

### 6.1.6 Error DLL

- 6499 "Cannot find bit resource with id 0x%X in DLL:\n'%s'"
- 6500 "Error handling bit resource with id 0x%X in DLL:\n'%s'"
- 6502 "Unable to find device '%s' in DLL:\n'%s'"

### 6.1.7 Error USB

- 4015 "USB device driver error 0x%04X in '%s'.\n\nCannot recover from this error, exiting.\n\nPlease check if the programmer power is on. If yes, disconnect the USB cable from computer and connect it again, then restart the %s shell."
- 4016 "All sites reported USB device driver error.\n\nCannot recover from this error, exiting.\n\nPlease check if the programmer(s) power is on. If yes, disconnect the USB cable from computer and connect it again, then restart the %s shell."
- 4017 "The following site(s):\n\n%s\n\nreported USB device driver error.\n\nThese site(s) will be removed from the gang programming process.\n\nPlease check if the programmer(s) power is on. If yes, disconnect the USB cable from computer and connect it again, then restart the %s shell."

### 6.1.8 Error programmer hardware

- 6546 "Source area does not fit into destination address space"
- 4005 "Attempt to read memory beyond buffer end: Addr = %s, len = %u bytes"
- 6988 "Unable to establish connection with programmer hardware. Please check if:\n\n"
- 4006 "Attached programmers have duplicate serial number '%s'"
- 4010 "This programmer with serial number '%s' has been already assigned the site number = %u"
- 4011 "This gang programmer with serial number '%s' has been already assigned the site numbers = %u..%u"
- 4013 "The programmers attached are of different types and cannot be used for gang mode.\n\nExiting."

4014 "ExecFunction() does not work in Gang mode"

4020 "%s reported hardware error 0x%X, error group 0x%X. If problem persists, please contact Phytion."

4000 "The attached programmer with id = %u is not supported"

4102 "Device programming countdown value is zero%s"

### 6.1.9 Error internal

6527 "Internal error:\nCORE() for %s %s returned NULL.\nPlease contact your %s distributor."

4025 "Internal Error: Unable to allocate %u bytes for the buffer. Please contact Phytion."

### 6.1.10 Error configuration

6503 "No programmer configuration files found (prog.ini)"

5325 "The device type '%s %s' stored in configuration "  
"or chosen from script file function 'SetDevice()' is not supported by %s.\n"  
"The device '%s %s' will be selected.\n"  
"Use 'Configure / Select device' to choose the device "  
"you need to operate on."

4002 "The '%s' configuration option has been set to an illegal state due to the data read from file. Setting this option to its default state ('%s')."

### 6.1.11 Error device

5326 "Device selection error"

4018 "Device '%s' is not supported by the %s. Please choose another device."

### 6.1.12 Error check box

6852 "Error in check box option specification string: '=' expected"

6853 "Cannot find check box option string '%s'"

### 6.1.13 Error mix

5195 " Number of repetitions cannot be zero"

5206 "The 'View only' option is on; editing disabled. Click the 'View' button on toolbar to enable editing."

6501 "No power-on tests defined in:\n'%s'"

6903 "'%s' is a sub-menu name, not a function name"

6401 "No more occurrences"  
6387 "Invalid fill string"  
5172 "Checksum = %08IX"  
5311 "No more mismatches"

### 6.1.14 Warning

5338 "Warning: JEDEC file has no file CRC"  
5339 "Warning: JEDEC file has invalid CRC"  
6933 "Warning: no 'file end' record in file"  
6845 "Attention! The %s %s device must be inserted into the programmer's socket shifted by %d row(s) relative to the standard position as shown in the Device Information window."  
6846 "Attention! Insert device into socket shifted by %d row(s) as shown on the picture."

## 6.2 Expressions

Expressions in the program are the mathematical constructions for calculating results with the use of one or more operands. It supports various [operations on expressions](#). The following operands are used:

- [numbers](#)
- [example of expressions](#)

When a number is required, you may use an expression; `<%CM%>` will accept the value of the expression. For example, when using the **Modify** command in the **Buffer** window, you can enter the new value in the form of a number or arithmetic expression.

### Interpreting the expression result

The expression result is interpreted in accordance with the context in which it is used.

In the dialog box, when an address is required, the program tries to interpret the expression's value as the address. If you enter a variable name, the result of the expression will be the variable's address but not the value of the variable.

If the dialog expects a number to be entered, the expression's value will be interpreted as a number (for example, the **Modify Memory** dialog box of the **Buffer Dump** window). If you enter a variable name there, then the result will be the value of the variable, but not its address.

Nonetheless, you can follow the default rules:

If you need to use the variable's **value**, where an address is expected, then you can write something like `var + 0`. In this case, the variable's value will be used in the expression.

If you need to use the variable **address**, apply the **&** (address) operation, that is, `&var`.

### 6.2.1 Operations with Expressions

The program supports all arithmetic and logical operations valid for the C language, as well as pointer

and address operations:

<u>Designation</u>	<u>Description</u>
( )	Brackets (higher priority)
[ ]	Array component selector
.	Structure component or union selector
->	Selection of a structure component or a union addressed with a pointer
!	Logical negation
~	Bitwise inversion
-	Bitwise sign change
&	Returns address
*	Access by address
(type)	Explicit type conversion
(sizeof)	(returns size of operand, in bytes)
*	Multiplication
/	Division
%	Modulus operator (produces the remainder of an integer division)
+	Addition
-	Subtraction
<<	Left shift
>>	Right shift
<	Less than
<=	Less than or equal to
>	Greater than
>=	Greater than or equal to
==	Equal to
!=	Not equal to
&	Bitwise AND
^	Bitwise XOR
	Bitwise OR



<code>&amp;&amp;</code>	Logical AND
<code>  </code>	Logical OR
<code>=</code>	Assignment

The types of operands are converted in accordance with the ANSI standard.

The results of logical operations are 0 (false) or 1 (true).

Allowed type conversions:

- Operands can be converted to simple types (char, int, ... float).
- Pointers can be converted to simple types (char \*, int \*, ... float \*) and to structures or unions.
- The word "struct" is not necessarily (MyStruct \*).

## 6.2.2 Numbers

By default, numbers are treated as decimals. Integers should fit into 32 bits; floating point numbers should fit into the single precision format (32 bits).

The following formats are supported:

1) Decimal integer.

Example: `126889`

2) Decimal floating point.

Examples: `365.678`; `2.12e-9`

3) Hexadecimal.

`<%CM%>` understands numbers in C format and assembly format.

Examples: `0xF6D7`; `0F6D7H`; `0xFFFF1111`

4) Binary.

Binary numbers must end with 'B'.

Examples: `011101B`; `1111111111111111000011B`

5) Symbol (ASCII).

Examples: `'a'`; `'ab'`; `'$B%8'.`.

## 6.2.3 Examples of Expressions

### Examples of expressions

```
#test#i + #test#j << 2
(unsigned char)#test#i + 2
sizeof(##array) > 200
```

```
main
i + j << 2 / :CW0x1200
(unsigned char)i + 2
sizeof(array) > 200
(a == b && a <= 4) || a > '3'
sptr -> Member1 -> a[i]
*p
*((char *)ptr)
```

## 6.3 Script Language

The program ChipProgUSB can execute so-called script files in a way similar to how DOS executes the batch files.

The main objective of script files is to automate usage of the emulator. Using script files makes it possible to load programs, set up breakpoints, start program execution, manipulate windows and perform any actions available to you in automatic (batch) mode. It is also possible to display various messages in the [Console window](#) or other special windows, to create user's custom menus, etc. There is the option of displaying any graphical data in special windows.

The script language is similar to C: almost all C constructions are supported, except for structures, conjunctives and pointers. However, there are some [differences](#). There are also many built-in functions available, such as printf(), sin() and strcpy().

The extension of script source file is **.CMD**.

[Simple example of a script file](#)

How to write a script file

How to start a script file

How to debug a script file

[Description of Script Language](#)

[Script Language Built-in Functions](#)

[Script Language Built-in Variables](#)

[Difference Between the Script Language and the C Language](#)

[Alphabetical List of Script Language Built-in Functions and Variables](#)

### 6.3.1 Simple example

This example shows how to load a file and automatically program it and display the result.

```
#include <system.h>
#include <mprog.h>

void main()
```

```
{
    LoadProgram("test.hex", F_HEX, SubLevel(0, 0));           // load file "test.hex" that is an Intel HEX
file                                                         //
to buffer 0, sub-level 0
    InsertTest = TRUE;                                       // set testing of chip presence to "on"
    if (ExecFunction("Auto Programming") == EF_OK)           // perform an automatic programming
    {
        if (ExecFunction("Verify", SubLevel(0, 0), 10) != EF_OK) // verify 10 times
        {
            printf("Verify failed: %s", LastErrorMessage);    // display error message if verify failed
            return;                                           // terminate script
        }
        printf("Verify ok.");                                 // display Ok result
    }
    else
        printf("Programming failed: %s", LastErrorMessage); // display error message
}
```

### 6.3.2 Description

The language used for writing the script files is similar to the C language. If you are familiar with the C language, you can skip this chapter and switch to reading about the [differences between the script language and the C language](#).

This manual contains just a few examples of programming in the script language. To find more examples, refer to books on the C language.

General Syntax of Script Language

Basic Data Types

Data byte order

Operations and Expressions

Operators

Functions

Descriptions

Directives of the Script File Language Preprocessor

Predefined Symbols in the Script File Compilation

### 6.3.3 Built-in Functions

The script file system provides you with a large set of built-in functions intended for work with lines, files, for mathematical calculations, and access to the processor resources. The **system.h** file contains descriptions of these built-in functions. You should include the **system.h** file in the script file source text with the `#include` directive:

```
#include <system.h>
```

You can use these built-in functions in the same way you use any function that you have defined.

Buffer access functions

Device programming control functions

Mathematical Functions

- String Operation Functions
- Character Operation Functions
- Functions for File and Directory Operation
- Stream File Functions
- Formatted Input-Output Functions
- Script File Manipulation Functions
- Text Editor Functions
- Control Functions
- Windows Operation Functions and Other System Functions
- Graphical Output Functions
- I/O Stream Window Operation Functions
  
- Event Wait Functions
- Other Various Functions

**Note.** To get help on a function or variable, while editing the script source with the <%CM%> built-in editor, point that function/variable name with the cursor and hit **Alt+F1**.

### 6.3.4 Built-in Variables

You can access script language built-in variables in the same way as regular global variables. However, some built-in variables are accessible only for reading, and in case of attempt to write to such variable.

The built-in variables are declared in the **system.h** header file.

#### **Programming variables:**

- InsertTest
- ReverseBytesOrder
- BlankCheck
- VerifyAfterProgram
- VerifyAfterRead
- ChipStartAddr
- ChipEndAddr
- BufferStartAddr
- LastErrorMessage
- DialogOnError

#### **Text editor built-in variables:**

- InsertMode
- CaseSensitive
- WholeWords
- RegularExpressions
- BlockCol1
- BlockCol2
- BlockLine1
- BlockLine2
- BlockStatus
- CurLine
- CurCol
- LastFoundString

#### **Miscellaneous variables:**

WorkFieldWidth  
 WorkFieldHeight  
 ApplName[]  
 DesktopName[]  
 SystemDir[]  
 errno  
 \_fmode  
 MainWindowHandle  
 NumWindows  
 WindowHandles[]  
 SelectedString[]  
 LastMessageInt  
 LastMessageLong

### 6.3.5 Difference between the Script and the C Languages

The script files are written in a C-type language and you should not expect it to meet standards. Many features are not supported because they are not necessary and complication of the language can cause compiler errors (the script file language compiler is not a simple thing).

- Pointers are not directly supported. But arrays are supported, therefore a pointer can always be built from an array and element number. Note that, for example, string operation functions, such as `strcpy`, receive a string and a byte number (index) as parameters, which form the pointer. In function declarations, index is equal to zero by default.
- Pointers to functions are not supported. If necessary, a table call can always be replaced with the **switch** operator.
- Multidimensional arrays are not supported. If it is necessary, you can write a couple of functions, such as:

```
int GetElement(int array[], int index1, int index2);
void SetElement(int array[], int index1, int index2, int value);
```

- Structures (and unions) are not supported. In fact, you can always do without structures. Structures may be required for API Windows and user DLLs operations, but as a rule only experienced programmers should do it, such as those who know how to reach structure elements. As a tip, there are functions, such as `memcpy`, which receive a void "pointer".
- Enumerated types (**enum**) are not supported `#define`.
- Preprocessor macros, such as **#define half(x) (x / 2)**, are not supported. The same operations can be done with functions.
- Conditional operators such as **x = y == 2 ? 3 : 4;**, are not supported; the operator "comma" outside

variable declaration is not supported. For example,

```
int i = 0, j = 1; is supported, but
for (i = 0, j = 1; ...) is not supported.
```

- **User** functions with a variable amount of parameters are not supported. However, there are many system functions, such as printf, with a variable number of parameters.
- Declaration of **user** function parameters such as **void array[]** is not supported. The system functions such as memcpy, have such parameters.
- Logical expressions are always fully computed. It is very important to remember it, as a situation like

```
char array[10];
if (i < 10 && array[i] != 0)
    array[i] = 1;
```

will cause an error at the execution stage, if *i* is greater than 9, because the expression of `array[i]` will be computed. In a standard compiler such an expression is not computed, because the condition of `i > 10` would cancel any further processing of the expression.

- Constant expressions are always computed during execution. For example, `int i = 10 * 22` will be computed not during compilation, but during execution.
- The **const** key word is absent.
- Static variables cannot be declared inside functions.

#### But

- Variables can be declared anywhere, not just in front of the first executed operator. For example:

```
void main()
{
    GlobalVar = 0;
    int i = 1;        // will be OK as in C++
}
```

- Nested comments are allowed.
- Expressions like `array = "1234"` are allowed.
- Default parameter values in declared functions, as in C++, are allowed. For example, `void func(char array[], int index = 0)`; Expressions can also serve as default values, for example `void func(char array[], int index = func1() + 1)`;
- Expressions in global variable initializers are allowed. For example:

```
float table[] = { sin(0), sin(0.1) };

void main()
{
    ...
}
```

### 6.3.6 Script Language Built-in Functions and Variables

The list below includes all the names of the script language built-in functions and variables:

```
AllProgOptionsDefault
API
ActivateWindow
AddButton
AddWatch
App!Name[]
```

BackSpace  
BlankCheck  
BlockBegin  
BlockCol1  
BlockCol2  
BlockCopy  
BlockDelete  
BlockEnd  
BlockFastCopy  
BlockLine1  
BlockLine2  
BlockMove  
BlockOff  
BlockPaste  
BlockStatus  
BufferStartAddr  
CaseSensitive  
Checksum  
ChipEndAddr  
ChipStartAddr  
ClearWindow  
CloseProject  
CloseWindow  
Cr  
CurChar  
CurCol  
CurLine  
Curcuit  
DelChar  
DelLine  
DesktopName[]  
DialogOnError  
DisplayText  
DisplayTextF  
Down  
Ellipse  
Eof  
Eol  
ExecFunction  
ExecMenu  
ExecScript  
ExitProgram  
Expr  
FileChanged  
FillRect  
FindWindow  
FirstWord

FloatExpr  
ForwardTill  
ForwardTillNot  
FrameRect  
FreeLibrary  
GetByte  
GetDword  
GetFileName  
GetLine  
GetMark  
GetMemory  
GetProgOptionBits  
GetProgOptionFloat  
GetProgOptionList  
GetProgOptionLong  
GetProgOptionString  
GetScriptFileName  
GetWindowHeight  
GetWindowWidth  
GetWord  
GotoXY  
InsertMode  
InsertTest  
Inspect  
InvertRect  
LastChar  
LastErrorMessage  
LastEvent  
LastEventInt{1...4}  
LastFoundString  
LastMessageInt  
LastMessageLong  
LastString  
Left  
LineTo  
LoadDesktop  
LoadLibrary  
LoadOptions  
LoadProgram  
LoadProject  
MainWindowHandle  
MaxAddr  
MessageBox  
MessageBoxEx  
MinAddr  
MoveTo  
MoveWindow



NumWindows  
OpenEditorWindow  
OpenStreamWindow  
OpenUserWindow  
OpenWindow  
Polyline  
ProgOptionDefault  
Rectangle  
RedrawScreen  
RegularExpressions  
ReloadProgram  
RemoveButtons  
ReverseBytesOrder  
Right  
SaveData  
SaveDesktop  
SaveFile  
SaveOptions  
Search  
SearchReplace  
SelectBrush  
SelectFont  
SelectPen  
SelectedString[]  
SetBkColor  
SetBkMode  
SetByte  
SetCaption  
SetDevice  
SetDWord  
SetFileName  
SetMark  
SetMemory  
SetPixel  
SetProgOption  
SetTextColor  
SetToolBar  
SetUpdateMode  
SetWindowFont  
SetWindowSize  
SetWindowSizeT  
SetWord  
SystemDir[]  
TerminateAllScripts  
TerminateScript  
Text  
Tof

Up  
UpdateWindow  
VerifyAfterProgram  
VerifyAfterRead  
WaitEprTrue  
WaitGetMessage  
WaitSendMessage  
WaitWindowEvent  
WholeWords  
WindowHandles[]  
WindowHotkey  
WordLeft  
WordRight  
WorkFieldHeight  
WorkFieldWidth  
\_GetWord  
\_ff\_attrib  
\_ff\_date  
\_ff\_name  
\_ff\_size  
\_ff\_time  
\_fmode  
\_fullpath  
\_printf  
abs  
acos  
asin  
atan  
atof  
atoi  
ceil  
chdir  
chsize  
clearerr  
close  
cos  
creat  
creatnew  
creattemp  
delay  
difftime  
dup  
dup2  
eof  
errno  
exec  
exit

exp  
fabs  
fclose  
fdopen  
feof  
ferror  
fflush  
fgetc  
fgets  
filelength  
fileno  
findfirst  
findnext  
floor  
fmod  
fnmerge  
fnsplit  
fopen  
fprintf  
fputc  
fputs  
fread  
freopen  
frexp  
fscanf  
fseek  
ftell  
fwrite  
getc  
getcurdir  
getcwd  
getdate  
getdfree  
getdisk()  
getenv  
getftime  
gettime  
getw  
inport  
inportb  
isalnum  
isalpha  
isascii  
isatty  
iscntrl  
isdigit  
isgraph

islower  
isprint  
ispunct  
isspace  
isupper  
isxdigit  
itoa  
lock  
locking  
log  
log10  
lseek  
ltoa  
memccpy  
memchr  
memcmp  
memcpy  
memicmp  
memmove  
memset  
mkdir  
movmem  
mprintf  
open  
outport  
outportb  
peek  
peekb  
poke  
pokeb  
pow  
pow10  
printf  
pscanf  
putc  
putenv  
putw  
rand  
random  
randomize  
read  
rename  
rewind  
rmdir  
scanf  
searchpath  
setdisk

setftime  
setmem  
setmode  
sin  
sprintf  
sqrt  
srand  
sscanf  
stpcpy  
strcat  
strchr  
strcmp  
strcmpi  
strcpy  
strcspn  
stricmp  
strlen  
strlwr  
strncat  
strncmp  
strncmpi  
strncpy  
strnicmp  
strnset  
strpbrk  
strrchr  
strev  
strset  
strspn  
strstr  
strtol  
strtoul  
strupr  
tan  
tanh  
tell  
toascii  
tolower  
toupper  
ultoa  
unlink  
unlock  
wgetchar  
wgethex  
wgetstring  
wprintf  
write

## 6.4 In-System Programming for different devices

**NOTE! Always carefully check connecting your ChipProg programmer to the target. Wrong connecting may and probably will cause destruction of the programmer's and/or the target system's hardware.**

Most embedded microcontrollers have different algorithms for the ISP procedure. See the following topics regarding the ISP for popular microcontrollers:

[Specific of the in-system programming of the Microchip PICmicro](#)

[Specific of the in-system programming of the Atmel AVR microcontrollers](#)

[Specific of the in-system programming of the Atmel 8051 microcontrollers](#)

### 6.4.1 Specific of programming PICmicro

1. Most of the PIC microcontrollers produced by Microchip Technology Corporation require a special HV ISP Programming Mode (High-Voltage in-System Programming Mode). In this mode a relatively high voltage of 13V is applied to the MCLR device pin. The user's equipment to be programmed should be designed in the way tolerating a 13V signal to be applied to the MCLR device pin - in particular this pin should not be connected to the Vcc pin of the device.
2. Though the PIC microcontrollers are capable to work in a certain range on the Vcc voltage (the range varies from 2 to 5V for some PICmicro derivatives) the device being under programming must have the 5V voltage level applied to the Vcc device pin. If in the working mode the target microcontroller works under the Vcc lower than 5V and the target cannot tolerate applying the 5V voltage to the Vcc pin, then, if the user needs to program the PICmicro device in-system, it is necessary to change the schematic to have an ability to connect 5V to the Vcc pin while the target is under the programming. However, verification of the correct programming can be conducted under the voltages allowed by the manufacturer (Vcc min - Vcc max).

### 6.4.2 Specific of programming AVR microcontrollers

Microcontrollers of the Atmel AVR series can be programmed in-system being under a normal Vcc voltage. Practically all AVR microcontrollers require clocking while they are under in-system programming. ChipProg programmers are capable to send clocks to the target microcontroller but sometimes the systems based on AVR microcontrollers have their own built-in clock generators.

1. If the system **has its own built-in clock generator** then make sure that the clock line of the ChipProg cable adapter **is not connected** to the clock input pin of the target microcontroller, otherwise it may destroy either the target or programmer hardware. What you need in this case is just to enter a value of the generator clock frequency in the **Algorithm Parameters > Oscillator Frequency** field in the [Device and Algorithm Parameters Editor](#) window (see on the picture below). By default the **Oscillator Frequency** value is 2.5 MHz. To change it double click the **Oscillator Frequency** line displayed in blue color and enter the Fclk value into the popped up dialog. If the actual clock frequency differs from the value set in the window the correct programming will be impossible.

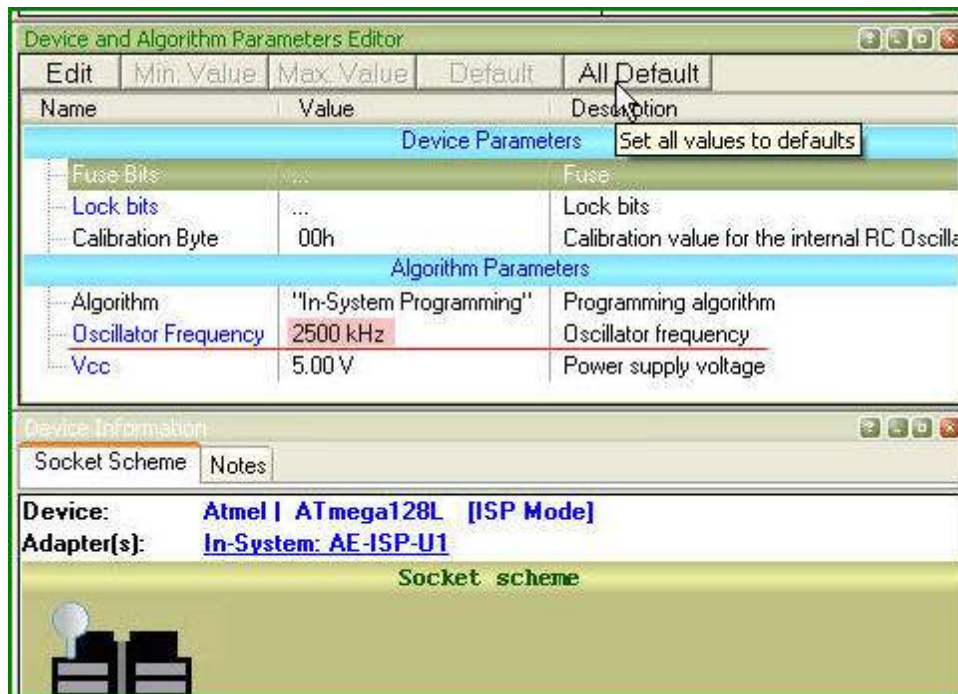

2. If the target system **does not have its own built-in clock generator** then, the target AVR device needs to get clocks from the ChipProg built-in generator; thus the clock output wire of the cable-adaptor should be connected to an appropriate clock input pin of the target device. By default the Fclk= 2.5 MHz. It can be set in the range of the Fclk allowed for a particular selected target AVR device in the **Algorithm Parameters > Oscillator Frequency** field in the [Device and Algorithm Parameters Editor](#) window (see the picture above).

### 6.4.3 Specific of programming Atmel 8051 microcontrollers

Microcontrollers of the Atmel 8051 family (AT89 series) can be programmed in-system being under a normal Vcc voltage. Practically all these microcontrollers require clocking while they are under in-system programming. ChipProg programmers are capable to send clocks to the target microcontroller but sometimes the systems based on the Atmel 8051 microcontrollers have their own built-in clock generators.

1. If the system **has its own built-in clock generator** then make sure that the clock line of the ChipProg cable adapter **is not connected** to the clock input pin of the target microcontroller, otherwise it may destroy either the target or programmer hardware.
2. If the target system **does not have its own built-in clock generator** then, the target device needs to get clocks from the ChipProg built-in generator; thus the clock output wire of the cable-adaptor should be connected to an appropriate clock input pin of the target device.

# Index

## - A -

- About
  - software version 65
- Acceptable number of errors
  - Tolerant Verify Feature 180
- Access mode
  - Device and Algorithm Parameters 176
  - Device Parameters 176
- Access Mode Parameters 178
- ACI 160, 163
  - DLL 123
  - External application 123
  - External control 123
- ACI examples 158
- ACI functions
  - ACI structures 125
- ACI structures
  - ACI functions 140
- Adapters 83
- Adapters attachment
  - list 85
- Adapters Connections List 83
- Add Watch
  - dialog 121
- Algorithm Parameters 71
- Alphabetical List of Script Language Built-in Functions and Variables 198
- Angstrom SAV 81
- Application Control Interface
  - ACI 123
  - ACI functions 123
  - ACI header 123
  - ACI structures 123
  - DLL 123
  - External application 123
  - External control 123
  - Programming automation 123
- Application Control Interface examples 158
- ASCII Hex 81
- Auto Programming 67
- Auto-detect
  - device in a socket 166
- Auto-detect device in a socket 166

- Automatic Word Completion 115
- AutoWatches
  - pane 119
- AutoWatches pane 119
- AVR microcontroller 206

## - B -

- Backspace unindents 59
- Bad Block Management 176
- Bad block map
  - Bad blocks 173
  - Invalid blocks 173
- Bad blocks 172, 174
- Binary image 81
- Block Operations 116
- Blocks
  - copying / moving 116
  - line blocks 116
  - non-persistent blocks 116
  - persistent 59
  - persistent blocks 116
  - standard blocks 116
  - vertical 59
  - vertical blocks 116
- Buffer 10
- Buffer Configuration
  - dialog 46
- Buffer Dump
  - window 74
- Buffers
  - dialog 45
  - memory allocation 45

## - C -

- Calculator
  - dialog 62
- Check Blank 167
- Checksum 50
- ChipProg
  - main menu 39
- ChipProg programmers 12
- ChipProg-40 34
  - brief characteristics 22
  - bundle 21
  - hardware characteristics 23



- ChipProg-40 34
  - software characteristics 23
- ChipProg-48 33
  - brief characteristics 20
  - bundle 19
  - hardware characteristics 20
  - software characteristics 20
- ChipProg-481 32
  - brief characteristics 15, 17
  - bundle 14
  - hardware characteristics 15
  - software characteristics 15
- ChipProg-G4
  - hardware characteristics 18
- ChipProg-G41 17, 33
  - bundle 16
  - software characteristics 18
- ChipProg-ISP 35
  - brief characteristics 26
  - bundle 24
  - hardware characteristics 27
  - software characteristics 27
- CLI 11
- Colors 56
  - tab 56
- Command line 11, 160
- Command Line Interface 11
- Command Line Keys 92, 94
- Command Line Mode 11
- Command Line Options 94
- Command Line Parameters 94
- Commands
  - menu 62
- Commands Menu 62
- Condensed Mode 114
- Condensed Mode Setup
  - dialog 114
- Configuring Editor
  - dialog 59
- Configuration 44
  - buffer 46
  - editor Options 44
  - environment 44
- Configuration Files 41
- Configuration Menu 44
- Configure the device to be programmed 168
- Configuring a Buffer
  - dialog 75

- Confirm Replace
  - dialog 112
- Console
  - window 86
  - Window Console 86
- Contact Information 37

## - D -

- Define Font 55
- Define key 57
- Definitions
  - adapter 9
  - buffer 9
  - memory buffer 9
  - sub-level 9
- Description of Script Language 195
- Detect
  - device in a socket 166
- Device
  - set into a socket 166
- Device and Algorithm Parameters
  - window 71
- Device Information
  - window 83
- Device Parameters 71
- Device programmer ChipProg-481 14
- Device serialization 48
- Difference Between the Script Language and the C Language 197
- Discard device 48
- Discard serial numbers 48
- Display from address
  - dialog 78
- Display from Line Number
  - dialog 116
- Display Watches Options
  - dialog 120
- DLL 160, 163
- Drivers
  - USB 31
- Duplicate a device 170

## - E -

- ECC 173
  - ECC frame 180

Edit Information to be programmed 168  
 Edit Key Command  
   dialog 61  
 Editor Key Mapping  
   tab 61  
 Editor window 108  
 Environment  
   dialog 55  
 Erase 167  
 Error Checking and Correction 173, 180  
 Even byte 69  
 Examples of ACI use 158  
 Examples of Expressions 193  
 Expressions 191

## - F -

File format 81  
 File Menu  
   overview 40  
 Fonts 55  
   tab 55

## - G -

Gang 16  
 Gang machine 16  
 Gang programmer 16  
 General Editor  
   settings 59  
 Guard Solid Area 177  
 GUI 38

## - H -

Help  
   menu 65  
   On-line 36  
 Highlight  
   multi-line Comments 59  
 Highlight Active Tabs 58  
 Highlighting  
   Syntax 59, 115  
 History file 41  
 Holtek OTR 81  
 Hot Keys 57  
 How to Get On-line Help 36

How to start a script file 117  
 How to write a script file 107

## - I -

I/O Stream  
   window 122  
 ICP 9  
 Insert DIP in socket 166  
 Install ChipProg 29  
 Install the ChipProg Software 29  
 Installing the USB Drivers 31  
 In-System programming 186, 206  
 Introduction 9  
 Invalid block  
   Array 172  
   Spare area 172  
 Invalid Block Indication  
   IB displaying 178  
 Invalid Block Management 176  
 Invalid block map 173  
 Invalid blocks  
   ECC 172  
   Error Checking and Correction 172  
   Reserved Block Area method 172  
   Skip Block method 172  
 ISP  
   ISP HV Mode 9  
   ISP Mode 9

## - J -

JEDEC 81

## - L -

LabVIEW 160, 163  
 List  
   Adapters connections 83  
 Load file  
   dialog 80  
 Load session 41  
 Load the file into the buffer 168  
 Log file 52

**- M -**

- Main menu
  - commands 39
- Main menu bar 39
- Mapping
  - hot keys 57
- Marking bad blocks 174
- MCS-51 microcontroller 207
- Memory Dump Window Setup
  - dialog 76
- Memory Blocks
  - operations 78
- Menu
  - Project 42
  - View 41
- Menu File 40
  - load file 40
  - save file 40
- Menu Help 65
- Menu Script 63
- Message box
  - always display 58
- Messages
  - tab 58
- Microchip PICmicro microcontroller 206
- Miscellaneous Settings 58
- Modify Address
  - dialog 78
- Modify Memory
  - dialog 78
- Motorola S-record 81
- Multi-File Search Results
  - dialog 113
- Multi-programming mode 181

**- N -**

- NAND 170
- NAND Flash 170
  - Block 170
  - Large page 170
  - NAND Flash architecture 170
  - Small page 170
- NAND Flash memory
  - Programming NAND devices 170

- NAND Flash programming
  - Access mode 175
  - Device and Algorithm Parameters 175
  - Device Parameters 175
- Numbers 193

**- O -**

- Odd byte 69
- On-line Help 36
- On-the-Fly
  - On-the-Fly Command Line Options 98
  - On-the-Fly Options 98
- On-the-Fly Control
  - Example 103
  - On-the-Fly Control utility 97
- On-the-Fly utility return codes
  - return codes 102
- Open Project 43
  - dialog 43
- Operations with Expressions 191
- Operations with Memory Blocks 78
- Options
  - dialog 53
- Options&split
  - dialog 68, 183
- Overview
  - User Interface 38

**- P -**

- Packages/Adapters 45
- POF 81
- Preferences 53
- PRG 81
- Program a Device 167
- Program Manager 66
  - Auto Programming 66, 183
  - dialog 66, 183
  - Operation Progress 66, 183
  - window 65, 182
- Programmer 9
  - ChipProg-40 34
  - ChipProg-48 33
  - ChipProg-481 32
  - ChipProg-G41 33
  - ChipProg-ISP 35

- Programmer 9
  - work with 166
- Programmers
  - ChipProgUSB 12
- Programmers ChipProg-40 21
- Programmers ChipProg-48 19
- Programmers ChipProg-481 14
- Programmers ChipProg-G41 16
- Programmers ChipProg-ISP 24
- Programming
  - check blank 167
  - configure the device 168
  - duplicate a device 170
  - edit Information 168
  - erase 167
  - load the file 168
  - program a Device 167
  - program functions 167
  - read a device 169
  - save the data 169
  - verify 169
  - write Information into the Device 168
- Programming adapters 83
- Programming automation 123
- Programming characteristics
  - AVR microcontroller 206
  - MCS-51 microcontroller 207
  - PICmicro microcontroller 206
- Programming in target board 186, 206
- Project 91
- Project Menu 42
- Project options 42, 91
  - dialog 42
- Project Repository
  - dialog 43
- Projects 91

## - Q -

- Quick Start 29
- Quick Watch
  - enabled 58
- Quick Watch Function 116

## - R -

- Read a Device 169

- Regular Expressions
  - search for 113
- Remote control 92
- Replace Text
  - dialog 111
- Repository 43
- Reserved Block Area 172
- Reserved Block Area Parameters
  - RBA 180
  - RBA parameters 180
  - Reserved Block Area 180
- Run ChipProg 11

## - S -

- Save file from buffer
  - dialog 82
- Save session 41
- Save the data read out from a device 169
- Script 105, 194
  - menu 63
- Script Files 105, 194
  - dialog 105
- Script Language Built-in Functions 195
- Script Language Built-in Variables 196
- Script source window
  - open 105
- Search for Regular Expressions 113
- Search for Text
  - dialog 110
- Search mask 45
- Select color 56
- Select device 45
  - dialog 45
- Serial number 48
- Serialization 49
- Serialization, Checksum, Log file
  - dialog 47
- Set device into a socket 166
- Set/Retrieve Bookmark
  - dialog 114
- Signature String 51
- Simple example of a script file 194
- Skip Block method
  - Bad blocks 172
  - Invalid blocks 172
- Skipping invalid blocks 172
- Solid Area 177

Solid Area Parameters  
  Number of Blocks 179  
  Start Block 179  
Sounds 53  
Spare Area Usage  
  SpareArea 176  
Split data 69  
Standard/Extended Intel HEX 81  
Statistics  
  dialog 70, 184  
Sub-layer  
  additional 47  
  main 46  
Sub-Layer 'Code' 46  
Sub-layer 'ID location' 47  
Support 36  
Syntax Highlighting 115  
System Requirements 11

## - T -

Tab Size 59  
Technical Support 36  
Terminology 9  
Terminology and Definitions 9  
Text Edit 109  
Tolerant Verify Feature  
  Tolerant Verify 178  
Toolbar  
  tab 57

## - U -

Undo Count 59  
USB Drivers 31  
User  
  window 121  
User area  
  Number of blocks 179  
  Start block 179  
User Block Area  
  Bad blocks 172  
  Block reservoir 172  
  Invalid blocks 172  
  RBA 172  
  UBA 172  
User Interface 38

overview 38

## - V -

Verify programming 169  
View 41  
View Menu 41

## - W -

Watches  
  window 119  
Watches Window  
  add Watch 121  
  display Watches Options 120  
Window  
  menu 64  
  Menu Window 64  
Window Device Information 83  
Window Dump Setup  
  dialog 76  
Window Editor 108  
Window I/O Stream 122  
Window Program Manager 65, 182  
Window User 121  
Window Watches 119  
Windows 65  
Word Completion 115  
Work with Programmer 166  
Write Information into the Device 168

Back Cover