

GloTek, Inc. www.globtek.com 186 Veterans Drive, Northvale, NJ 07647 Tel. (201) 784-1000 Fax (201) 784-0111	Drawing Title: GTM43007-C6024-FW, ICT / ITE / Medical Power Supply, Efficiency Level: N/A, Case Color/Style: GlobTek Black, Open Frame/Internal, Regulated Switchmode AC-DC Power Supply AC Adaptor, Input Rating: 100-240V~, 50-60 Hz, Molex Header (or equal) , Output Rating: 60W, 24.0V@2.5A, Output Configuration: N/A mm, N/A/4 Cond. , Molex 2.54mm Pitch 4-Pin Header PN: 22-11-2042 MATES W/ PN: 22-01-2047 or Equivalent, Ferrite: None, N/A, GT Cord # C0127, Pin Out: Pins 1 and 2: +V, Pins 3 and 4: -V, Blades/Input Cord: Not Applicable, Approvals: CB 62368; ETL 62368; EAC; UKCA; Conforms to 62368-1; CCC; Book 60601; CB 60601-1 2MOPP (6W max); CE; China RoHS; Double Insulation; RoHS; Ukraine; WEEE; CE; FCC; Fuse 60335; CB 60950; CB EN/IEC 60335-1; Fuse 60335; Level V; LPS 60950; WDaE; cETLus ES60601; cETLus; cETLus 60601-1 3rd;	
	Model No. GTM43007-C6024-FW	
	Part No./Ordering No. GTM43007-C6024-FW(R)	Rev B

In Addition to GlobTek Inc.'s renewed ISO9001:2015 - Quality Management System Certification, GlobTek Inc. is now certified to:

ISO13485:2016 - Medical Devices Quality Management System Certification

ISO14001:2015 - Environmental Management System Certification

ISO Certificates are available online at <https://www.globtek.com/iso-certificates/>

The acceptance of this specification and use of the product described in this document indicates the acceptance and binding of the customer to Globtek TERMS AND CONDITIONS (attached to the end of this document), which supersede all other agreements, terms, and conditions (<https://en.globtek.com/terms-and-conditions/>).

The purchaser of this product (Customer) agrees that it is their sole responsibility to determine suitability/fitness of the product described in this specification for their application and to take precautions for protection against any hazards attendant to the handling and use of the product.

Footnote:

GlobTek Inc. will not be liable for the safety and performance of these power supplies/battery packs if unauthorized access and repair occurs. End user should consult applicable UL, CSA or EN standards for proper installation instruction.

Limitation of Use:

GlobTek products are intended for use with commercial, medical, and/or industrial equipment only. GlobTek product are not authorized for use as mission critical components in life support hazardous environment, nuclear or aircraft applications without prior written approval from the CEO of GlobTek Inc.

Contents of this document are subject to change without prior notice.

Customer Approval of Specification:

Please approve, sign and send back to GlobTek so we can complete order processing.

A delay in receipt of this form will delay delivery schedule.

Company Name: _____	Customer P/N: _____
Quote Number: _____	Date: _____
Authorized Representative Name: _____	Authorized Representative Signature: _____

GlobTek, Inc. www.globtek.com 186 Veterans Drive, Northvale, NJ 07647 Tel. (201) 784-1000 Fax (201) 784-0111	Drawing Title: GTM43007-C6024-FW, ICT / ITE / Medical Power Supply, Efficiency Level: N/A, Case Color/Style: GlobTek Black, Open Frame/Internal, Regulated Switchmode AC-DC Power Supply AC Adaptor, Input Rating: 100-240V~, 50-60 Hz, Molex Header (or equal) , Output Rating: 60W, 24.0V@2.5A, Output Configuration: N/A mm, N/A/4 Cond. , Molex 2.54mm Pitch 4-Pin Header PN: 22-11-2042 MATES W/ PN: 22-01-2047 or Equivalent, Ferrite: None, N/A, GT Cord # C0127, Pin Out: Pins 1 and 2: +V, Pins 3 and 4: -V, Blades/Input Cord: Not Applicable, Approvals: CB 62368; ETL 62368; EAC; UKCA; Conforms to 62368-1; CCC; Book 60601; CB 60601-1 2MOPP (6W max); CE; China RoHS; Double Insulation; RoHS; Ukraine; WEEE; CE; FCC; Fuse 60335; CB 60950; CB EN/IEC 60335-1; Fuse 60335; Level V; LPS 60950; WDaE; cETLus ES60601; cETLus; cETLus 60601-1 3rd;	
	Model No. GTM43007-C6024-FW	
	Part No./Ordering No. GTM43007-C6024-FW(R)	Rev B

REVISION HISTORY

REV	DESCRIPTION	SUB	DATE	APPROVED
B	Update Ukraine mark, RoHS 2 to RoHS, add EAC	QA	07/16/2018	QA
A	Initial Release	jwarr	05/02/2017	QA

POWER SUPPLY INFORMATION

TYPE	Open Frame/Internal
TECHNOLOGY	Regulated Switchmode AC-DC Power Supply AC Adaptor
CASE COLOR	GlobTek Black
NAMEPLATE RATED INPUT	100-240V~, 50-60 Hz, 1.5A
INPUT CONFIG	Molex Header (or equal)
WATTS	60.00
VOLTS OUT	24.0
CURRENT OUT (Amps)	2.5
BLADE/CORD INCLUDED	N/A Not Applicable
BLADE/CORD INSTALLED	N/A :Not Applicable
INGRESS PROTECTION	N/A
GROUNDING CONFIGURATION	(F1) Class II / Double Insulated
EFFICIENCY LEVEL	N/A
OUTPUT CONFIGURATION	N/A mm, N/A/4 Cond. , Molex 2.54mm Pitch 4-Pin Header PN: 22-11-2042 MATES W/ PN: 22-01-2047 or Equivalent, Ferrite: None, N/A, GT Cord # C0127
OVERMOLDED	No
CONNECTOR PIN OUT	Pins 1 and 2: +V, Pins 3 and 4: -V
LABEL SPECS	Standard GT,L-1186
SPECIAL BARCODE LABEL MATERIAL	No
PACK SPEC	
USER MANUAL	

PROPRIETARY INFORMATION

PROPRIETARY OF GLOBTEK, INC. ANY REPRODUCTION, DISCLOSURE OR USE OF THIS DRAWING, IN WHOLE OR IN PART, IS HEREBY PROHIBITED EXCEPT AS SPECIFIED IN WRITING BY GLOBTEK, INC. © GlobTek, Inc. 2017 - 2023

<p>GlobTek, Inc. www.globtek.com 186 Veterans Drive, Northvale, NJ 07647 Tel. (201) 784-1000 Fax (201) 784-0111</p>	<p>Drawing Title: GTM43007-C6024-FW, ICT / ITE / Medical Power Supply, Efficiency Level: N/A, Case Color/Style: GlobTek Black, Open Frame/Internal, Regulated Switchmode AC-DC Power Supply AC Adaptor, Input Rating: 100-240V~, 50-60 Hz, Molex Header (or equal) , Output Rating: 60W, 24.0V@2.5A, Output Configuration: N/A mm, N/A/4 Cond , Molex 2.54mm Pitch 4-Pin Header PN: 22-11-2042 MATES W/ PN: 22-01-2047 or Equivalent, Ferrite: None, N/A, GT Cord # C0127, Pin Out: Pins 1 and 2: +V, Pins 3 and 4: -V, Blades/Input Cord: Not Applicable, Approvals: CB 62368; ETL 62368; EAC; UKCA; Conforms to 62368-1; CCC; Book 60601; CB 60601-1 2MOPP (6W max); CE; China RoHS; Double Insulation; RoHS; Ukraine; WEEE; CE; FCC; Fuse 60335; CB 60950; CB EN/IEC 60335-1; Fuse 60335; Level V; LPS 60950; WDaE; cETLus ES60601; cETLus; cETLus 60601-1 3rd;</p>
	<p>Model No. GTM43007-C6024-FW</p>
	<p>Part No./Ordering No. GTM43007-C6024-FW(R) Rev B</p>

Notes/Modifications/Customizations (notes in this section supersede the values shown in the standard spec)
DIMENSIONS ARE IN MM UNLESS SPECIFIED OTHERWISE

GlobTek, Inc. www.globtek.com 186 Veterans Drive, Northvale, NJ 07647 Tel. (201) 784-1000 Fax (201) 784-0111	Drawing Title: GTM43007-C6024-FW, ICT / ITE / Medical Power Supply, Efficiency Level: N/A, Case Color/Style: GlobTek Black, Open Frame/Internal, Regulated Switchmode AC-DC Power Supply AC Adaptor, Input Rating: 100-240V~, 50-60 Hz, Molex Header (or equal) , Output Rating: 60W, 24.0V@2.5A, Output Configuration: N/A mm, N/A/4 Cond. , Molex 2.54mm Pitch 4-Pin Header PN: 22-11-2042 MATES W/ PN: 22-01-2047 or Equivalent, Ferrite: None, N/A, GT Cord # C0127, Pin Out: Pins 1 and 2: +V, Pins 3 and 4: -V, Blades/Input Cord: Not Applicable, Approvals: CB 62368; ETL 62368; EAC; UKCA; Conforms to 62368-1; CCC; Book 60601; CB 60601-1 2MOPP (6W max); CE; China RoHS; Double Insulation; RoHS; Ukraine; WEEE; CE; FCC; Fuse 60335; CB 60950; CB EN/IEC 60335-1; Fuse 60335; Level V; LPS 60950; WDaE; cETLus ES60601; cETLus; cETLus 60601-1 3rd;	
	Model No. GTM43007-C6024-FW	
	Part No./Ordering No. GTM43007-C6024-FW(R)	Rev B

ELECTRICAL SPECIFICATIONS

A) ELECTRICAL SPECIFICATIONS:

01. Input Voltage: Specified 90-264 Vac, Nameplate rated: 100-240Vac
02. Input Frequency: Specified 47-63 Hz, Nameplate rated 50-60Hz
03. Output Regulation: +/- 3% measured at the output connector
04. Line Voltage Regulation: +/- 0.5% maximum measured at full load
05. Output Ripple (Vp-p): +/- 1% of output voltage, Vp-p, max
06. Turn-ON/OFF: 5% maximum, 1 mS typical recovery time for 25% step load
07. Turn-ON Delay: 1 Sec max
08. Hold-Up Time: 10 mS typical @ nominal input voltage and full load
09. Inrush Current: 80A maximum @ 115 Vac input, 160A maximum @ 230 Vac input
10. Switching Frequency: 65 KHz typical
11. Efficiency: 87% @115Vac, 89% @ 230Vac typical at full load
12. No Load Power: < 300mW @ 230Vac

B) PROTECTION

01. Overvoltage Protection: 110% to 130% of nominal output voltage, and less than 60Vdc
02. Short Circuit/Over-load: momentary short circuit protected, output will auto recover upon removal of short

C) SAFETY

01. Dielectric Withstand Voltage: 4000Vac / 5656Vdc from primary to secondary
02. Earth Leakage Current: Does not exceed 300uA in NORMAL CONDITION and 1000uA in SINGLE FAULT CONDITION
03. Output Leakage Current: Does not exceed 75uA NC(Normal condition) 300uA SFC(single fault condition)
05. Earth continuity test:<0.1 Ohm, Class I Only
06. Mode of operation: Continuous
07. Means of Protection: 2 x MOPP
08. Compliant Standards: See listings at end of this drawing for specifics

D) EMC

EN 60601-1-2, 4th edition

Emissions, per EN 55032, EN 61000-6-3, EN 61000-6-4

Conducted Emissions: Class B, FCC Part 15, Class B

Radiated Emissions: Class B, FCC Part 15, Class B

Line Frequency Harmonics EN61000-3-2, Class A

Voltage Fluctuations/Flicker EN61000-3-3

Immunity, per EN 55024, EN 61000-6-1, EN 61000-6-2

Static Discharge Immunity EN61000-4-2, 10kV Contact Discharge, 20kV air discharge

Radiated RF Immunity EN61000-4-3, 10V/m 80-1000MHz, 3V/m 1-2.7GHz, 80% 1KHz AM.

EFT/Burst Immunity EN61000-4-4, 4kV/100kHz.

Line Surge Immunity EN61000-4-5, 2kV differential, 4kV common-mode

Conducted RF Immunity EN61000-4-6, 3Vrms, 80% 1KHz AM

Power Frequency Magnetic Field Immunity EN61000-4-8, 3A/m

Voltage Dip Immunity EN61000-4-11, Criteria

E) OTHER

PROPRIETARY INFORMATION

PROPRIETARY OF GLOBTEK, INC. ANY REPRODUCTION, DISCLOSURE OR USE OF THIS DRAWING, IN WHOLE OR IN PART, IS HEREBY PROHIBITED EXCEPT AS SPECIFIED IN WRITING BY GLOBTEK, INC. © GlobTek, Inc. 2017 - 2023

<p>GlobTek, Inc. www.globtek.com 186 Veterans Drive, Northvale, NJ 07647 Tel. (201) 784-1000 Fax (201) 784-0111</p>	<p>Drawing Title: GTM43007-C6024-FW, ICT / ITE / Medical Power Supply, Efficiency Level: N/A, Case Color/Style: GlobTek Black, Open Frame/Internal, Regulated Switchmode AC-DC Power Supply AC Adaptor, Input Rating: 100-240V~, 50-60 Hz, Molex Header (or equal) , Output Rating: 60W, 24.0V@2.5A, Output Configuration: N/A mm, N/A/4 Cond. , Molex 2.54mm Pitch 4-Pin Header PN: 22-11-2042 MATES W/ PN: 22-01-2047 or Equivalent, Ferrite: None, N/A, GT Cord # C0127, Pin Out: Pins 1 and 2: +V, Pins 3 and 4: -V, Blades/Input Cord: Not Applicable, Approvals: CB 62368; ETL 62368; EAC; UKCA; Conforms to 62368-1; CCC; Book 60601; CB 60601-1 2MOPP (6W max); CE; China RoHS; Double Insulation; RoHS; Ukraine; WEEE; CE; FCC; Fuse 60335; CB 60950; CB EN/IEC 60335-1; Fuse 60335; Level V; LPS 60950; WDaE; cETLus ES60601; cETLus; cETLus 60601-1 3rd;</p>
	<p>Model No. GTM43007-C6024-FW</p>
	<p>Part No./Ordering No. GTM43007-C6024-FW(R) Rev B</p>

01. MTBF: 1,000,000 Hours @ 45°C ambient temperature, Full Load
02. Operating Temperature: -10°C to 45°C ambient temperature
03. Humidity: 0% to 95% relative humidity
04. Storage Temperature: -30°C to 80°C
05. Cooling: Convection
06. Elevation: 5000M
07. ROHS: Complies with EU 2011/65/EU amended by EU 2015/863 and China SJ/T 11363-2006

F) MECHANICAL FORMAT

01. Type: Open Frame
02. Size: A suffix version, (2"x3"), 76.2 x 50.8 x 30.5 mm
03. Size: B suffix version, (2"x4"), 101.6 x 50.8 x 30.5 mm
04. Size: C suffix version, (3"x5"), 127.0 x 76.2 x 30.5 mm

G) SPECIAL OPTIONS

01. Custom Label Markings
02. Short term Output Surge Capability
03. Reduced Leakage Current versions
04. Tightened output voltage tolerance
05. Reduced output ripple level
06. High Rel PCB laminate with Plated through Holes for IPC610 Class 2 Compliance
07. Low Temperature operation, down to -40°C
08. Quasi Constant Current Output, for Lead-Acid Battery Charger Applications
09. Special Input or Output Connectors

<p>GlobTek, Inc. www.globtek.com 186 Veterans Drive, Northvale, NJ 07647 Tel. (201) 784-1000 Fax (201) 784-0111</p>	<p>Drawing Title: GTM43007-C6024-FW, ICT / ITE / Medical Power Supply, Efficiency Level: N/A, Case Color/Style: GlobTek Black, Open Frame/Internal, Regulated Switchmode AC-DC Power Supply AC Adaptor, Input Rating: 100-240V~, 50-60 Hz, Molex Header (or equal) , Output Rating: 60W, 24.0V@2.5A, Output Configuration: N/A mm, N/A/4 Cond. , Molex 2.54mm Pitch 4-Pin Header PN: 22-11-2042 MATES W/ PN: 22-01-2047 or Equivalent, Ferrite: None, N/A, GT Cord # C0127, Pin Out: Pins 1 and 2: +V, Pins 3 and 4: -V, Blades/Input Cord: Not Applicable, Approvals: CB 62368; ETL 62368; EAC; UKCA; Conforms to 62368-1; CCC; Book 60601; CB 60601-1 2MOPP (6W max); CE; China RoHS; Double Insulation; RoHS; Ukraine; WEEE; CE; FCC; Fuse 60335; CB 60950; CB EN/IEC 60335-1; Fuse 60335; Level V; LPS 60950; WDaE; cETLus ES60601; cETLus; cETLus 60601-1 3rd;</p>
	<p>Model No. GTM43007-C6024-FW</p>
	<p>Part No./Ordering No. GTM43007-C6024-FW(R) Rev B</p>

10. Over-Temperature Protection, Latched Shut-Down

TO ADDRESS SYSTEM-LEVEL EMI CONCERNS, FERRITE CHOKES/BEADS MAY BE ADDED/REVISED UPON REQUEST. A SAMPLE KIT OF GLOBTEK'S STANDARD FERRITES IS AVAILABLE UNDER GLOBTEK P/N: EMI-MITIGATION-KIT1

FOR ADDITIONAL INFORMATION, PLEASE READ OUR WHITE PAPER AT: <https://r.globtek.info/3QeaqtD>

INGRESS PROTECTION: N/A

GlobTek, Inc.
 www.globtek.com
 186 Veterans Drive,
 Northvale, NJ 07647
 Tel. (201) 784-1000
 Fax (201) 784-0111

Drawing Title: GTM43007-C6024-FW, ICT / ITE / Medical Power Supply, Efficiency Level: N/A, Case Color/Style: GlobTek Black, Open Frame/Internal, Regulated Switchmode AC-DC Power Supply AC Adaptor, Input Rating: 100-240V~, 50-60 Hz, Molex Header (or equal) , Output Rating: 60W, 24.0V@2.5A, Output Configuration: N/A mm, N/A/4 Cond. , Molex 2.54mm Pitch 4-Pin Header PN: 22-11-2042 MATES W/ PN: 22-01-2047 or Equivalent, Ferrite: None, N/A, GT Cord # C0127, Pin Out: Pins 1 and 2: +V, Pins 3 and 4: -V, Blades/Input Cord: Not Applicable, Approvals: CB 62368; ETL 62368; EAC; UKCA; Conforms to 62368-1; CCC; Book 60601; CB 60601-1 2MOPP (6W max); CE; China RoHS; Double Insulation; RoHS; Ukraine; WEEE; CE; FCC; Fuse 60335; CB 60950; CB EN/IEC 60335-1; Fuse 60335; Level V; LPS 60950; WDaE; cETLus ES60601; cETLus; cETLus 60601-1 3rd;

Model No. GTM43007-C6024-FW

Part No./Ordering No. GTM43007-C6024-FW(R)

Rev B

3D File Download <https://www.globtek.com/file/dl/GTM43007-C.zip>

Mechanical drawing

Top Diagram is for 5V-14V models, Bottom Diagram is for 15V-48V models

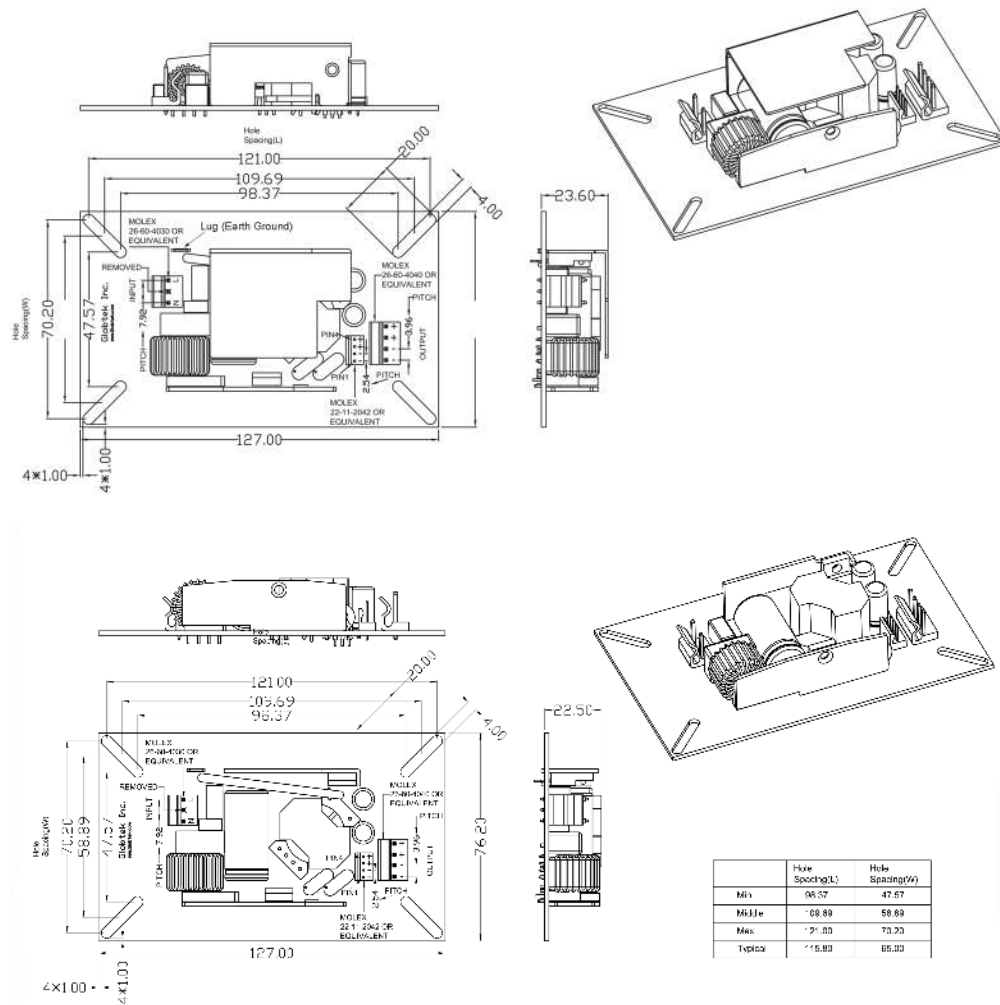

<p>GlobTek, Inc. www.globtek.com 186 Veterans Drive, Northvale, NJ 07647 Tel. (201) 784-1000 Fax (201) 784-0111</p>	<p>Drawing Title: GTM43007-C6024-FW, ICT / ITE / Medical Power Supply, Efficiency Level: N/A, Case Color/Style: GlobTek Black, Open Frame/Internal, Regulated Switchmode AC-DC Power Supply AC Adaptor, Input Rating: 100-240V~, 50-60 Hz, Molex Header (or equal) , Output Rating: 60W, 24.0V@2.5A, Output Configuration: N/A mm, N/A/4 Cond. , Molex 2.54mm Pitch 4-Pin Header PN: 22-11-2042 MATES W/ PN: 22-01-2047 or Equivalent, Ferrite: None, N/A, GT Cord # C0127, Pin Out: Pins 1 and 2: +V, Pins 3 and 4: -V, Blades/Input Cord: Not Applicable, Approvals: CB 62368; ETL 62368; EAC; UKCA; Conforms to 62368-1; CCC; Book 60601; CB 60601-1 2MOPP (6W max); CE; China RoHS; Double Insulation; RoHS; Ukraine; WEEE; CE; FCC; Fuse 60335; CB 60950; CB EN/IEC 60335-1; Fuse 60335; Level V; LPS 60950; WDaE; cETLus ES60601; cETLus; cETLus 60601-1 3rd;</p>
	<p>Model No. GTM43007-C6024-FW</p>
	<p>Part No./Ordering No. GTM43007-C6024-FW(R) Rev B</p>

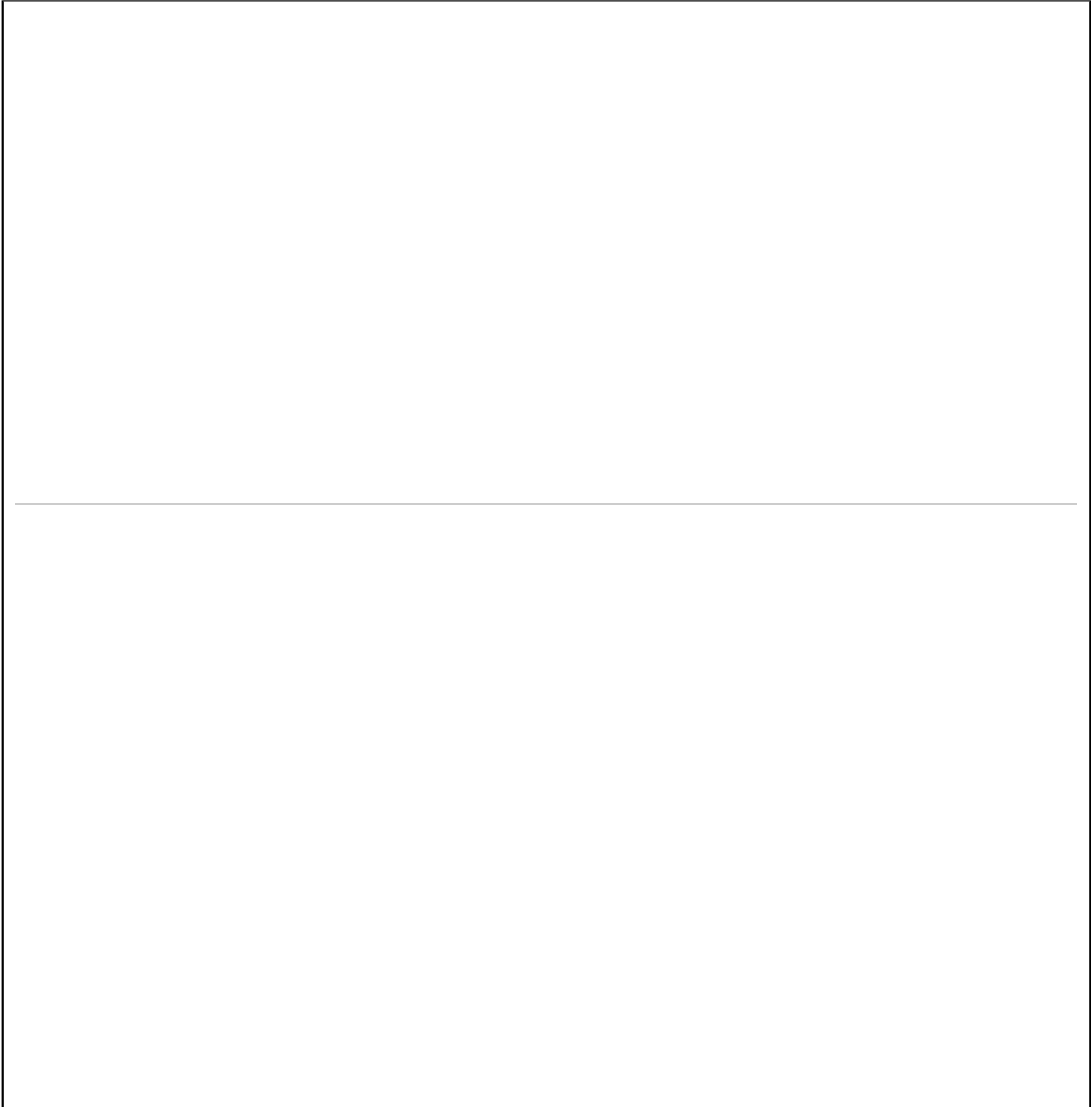

GlobTek, Inc.
 www.globtek.com
 186 Veterans Drive,
 Northvale, NJ 07647
 Tel. (201) 784-1000
 Fax (201) 784-0111

Drawing Title: GTM43007-C6024-FW, ICT / ITE / Medical Power Supply, Efficiency Level: N/A, Case Color/Style: GlobTek Black, Open Frame/Internal, Regulated Switchmode AC-DC Power Supply AC Adaptor, Input Rating: 100-240V~, 50-60 Hz, Molex Header (or equal) , Output Rating: 60W, 24.0V@2.5A, Output Configuration: N/A mm, N/A/4 Cond. , Molex 2.54mm Pitch 4-Pin Header PN: 22-11-2042 MATES W/ PN: 22-01-2047 or Equivalent, Ferrite: None, N/A, GT Cord # C0127, Pin Out: Pins 1 and 2: +V, Pins 3 and 4: -V, Blades/Input Cord: Not Applicable, Approvals: CB 62368; ETL 62368; EAC; UKCA; Conforms to 62368-1; CCC; Book 60601; CB 60601-1 2MOPP (6W max); CE; China RoHS; Double Insulation; RoHS; Ukraine; WEEE; CE; FCC; Fuse 60335; CB 60950; CB EN/IEC 60335-1; Fuse 60335; Level V; LPS 60950; WDaE; cETLus ES60601; cETLus; cETLus 60601-1 3rd;

Model No. GTM43007-C6024-FW

Part No./Ordering No. GTM43007-C6024-FW(R)

Rev B

DERATING CURVE

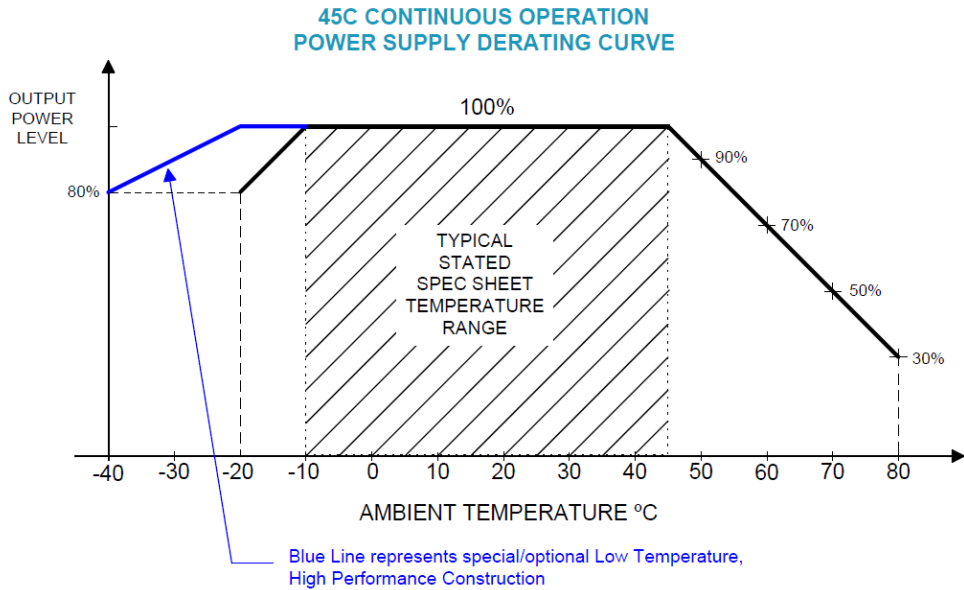

<p>GlobTek, Inc. www.globtek.com 186 Veterans Drive, Northvale, NJ 07647 Tel. (201) 784-1000 Fax (201) 784-0111</p>	Drawing Title: GTM43007-C6024-FW, ICT / ITE / Medical Power Supply, Efficiency Level: N/A, Case Color/Style: GlobTek Black, Open Frame/Internal, Regulated Switchmode AC-DC Power Supply AC Adaptor, Input Rating: 100-240V~, 50-60 Hz, Molex Header (or equal) , Output Rating: 60W, 24.0V@2.5A, Output Configuration: N/A mm, N/A/4 Cond. , Molex 2.54mm Pitch 4-Pin Header PN: 22-11-2042 MATES W/ PN: 22-01-2047 or Equivalent, Ferrite: None, N/A, GT Cord # C0127, Pin Out: Pins 1 and 2: +V, Pins 3 and 4: -V, Blades/Input Cord: Not Applicable, Approvals: CB 62368; ETL 62368; EAC; UKCA; Conforms to 62368-1; CCC; Book 60601; CB 60601-1 2MOPP (6W max); CE; China RoHS; Double Insulation; RoHS; Ukraine; WEEE; CE; FCC; Fuse 60335; CB 60950; CB EN/IEC 60335-1; Fuse 60335; Level V; LPS 60950; WDaE; cETLus ES60601; cETLus; cETLus 60601-1 3rd;	
	Model No. GTM43007-C6024-FW	
	Part No./Ordering No. GTM43007-C6024-FW(R)	Rev B

INPUT CONFIGURATION

(F1) Class II / Double Insulated

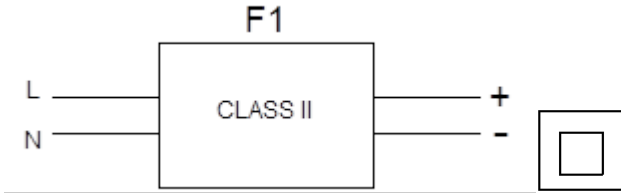

[Alternate grounding configurations](#) available upon request.

Blades/Cord Included:N/A:Not Applicable

Blades/Cord Installed:N/A:Not Applicable

Molex 26-60-4030 3 Position Header Pin 1: Line, Pin 2: Removed, PIN 3: Neutral

GlobTek, Inc.
 www.globtek.com
 186 Veterans Drive,
 Northvale, NJ 07647
 Tel. (201) 784-1000
 Fax (201) 784-0111

Drawing Title: GTM43007-C6024-FW, ICT / ITE / Medical Power Supply, Efficiency Level: N/A, Case Color/Style: GlobTek Black, Open Frame/Internal, Regulated Switchmode AC-DC Power Supply AC Adaptor, Input Rating: 100-240V~, 50-60 Hz, Molex Header (or equal) , Output Rating: 60W, 24.0V@2.5A, Output Configuration: N/A mm, N/A/4 Cond. , Molex 2.54mm Pitch 4-Pin Header PN: 22-11-2042 MATES W/ PN: 22-01-2047 or Equivalent, Ferrite: None, N/A, GT Cord # C0127, Pin Out: Pins 1 and 2: +V, Pins 3 and 4: -V, Blades/Input Cord: Not Applicable, Approvals: CB 62368; ETL 62368; EAC; UKCA; Conforms to 62368-1; CCC; Book 60601; CB 60601-1 2MOPP (6W max); CE; China RoHS; Double Insulation; RoHS; Ukraine; WEEE; CE; FCC; Fuse 60335; CB 60950; CB EN/IEC 60335-1; Fuse 60335; Level V; LPS 60950; WDaE; cETLus ES60601; cETLus; cETLus 60601-1 3rd;

Model No. GTM43007-C6024-FW

Part No./Ordering No. GTM43007-C6024-FW(R)

Rev B

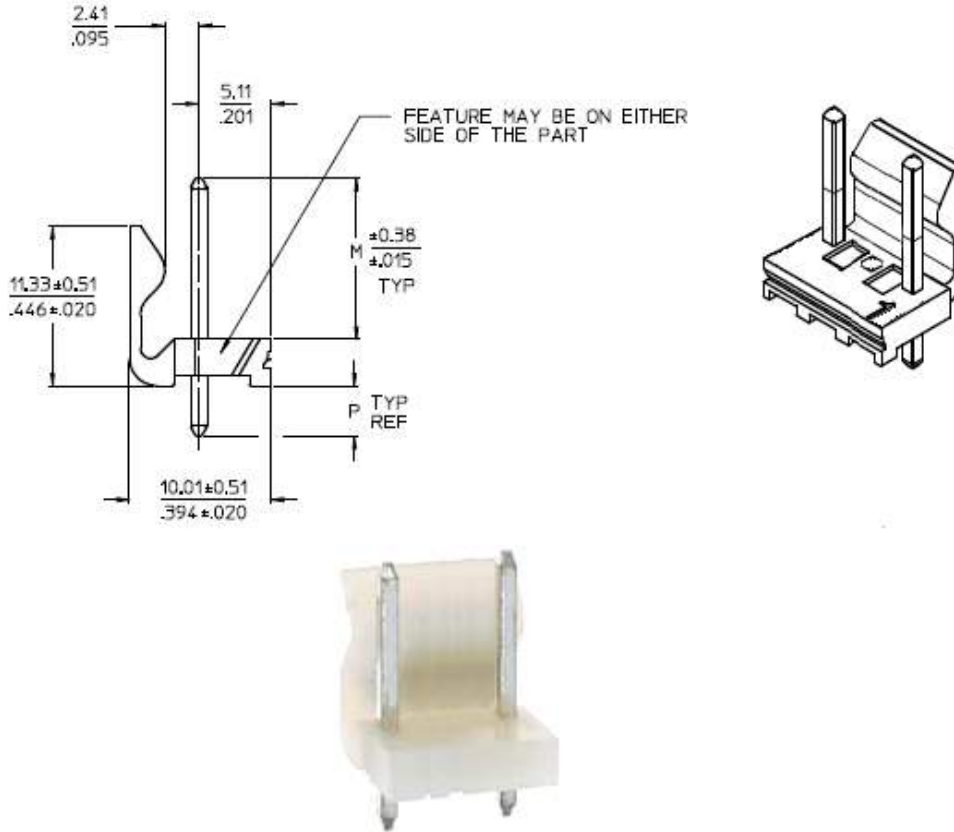

Optional Input Wiring Kits are available:

PN/Ordering No	Length	End A	End B
XHP410070M7MLX3(R)	70	JST XHP-4	Molex 09-93-0300
C810070M6MLX3(R)	60	IEC60320 C8	Molex 09-93-0300
C1410070M6MLX3(R)	60	IEC60320 C14	Molex 09-93-0300

Custom lengths, construction, cable types, ferrites, filters, and termination available upon request.

GloBtek, Inc. www.globtek.com 186 Veterans Drive, Northvale, NJ 07647 Tel. (201) 784-1000 Fax (201) 784-0111	Drawing Title: GTM43007-C6024-FW, ICT / ITE / Medical Power Supply, Efficiency Level: N/A, Case Color/Style: GloBtek Black, Open Frame/Internal, Regulated Switchmode AC-DC Power Supply AC Adaptor, Input Rating: 100-240V~, 50-60 Hz, Molex Header (or equal) , Output Rating: 60W, 24.0V@2.5A, Output Configuration: N/A mm, N/A/4 Cond. , Molex 2.54mm Pitch 4-Pin Header PN: 22-11-2042 MATES W/ PN: 22-01-2047 or Equivalent, Ferrite: None, N/A, GT Cord # C0127, Pin Out: Pins 1 and 2: +V, Pins 3 and 4: -V, Blades/Input Cord: Not Applicable, Approvals: CB 62368; ETL 62368; EAC; UKCA; Conforms to 62368-1; CCC; Book 60601; CB 60601-1 2MOPP (6W max); CE; China RoHS; Double Insulation; RoHS; Ukraine; WEEE; CE; FCC; Fuse 60335; CB 60950; CB EN/IEC 60335-1; Fuse 60335; Level V; LPS 60950; WDaE; cETLus ES60601; cETLus; cETLus 60601-1 3rd;	
	Model No. GTM43007-C6024-FW	
	Part No./Ordering No. GTM43007-C6024-FW(R)	Rev B

OUTPUT CORD AND CONNECTOR: MOLI/C0127

ACTUAL CONNECTORS, OVERMOLDS, FERRITES MAY VARY SLIGHTLY FROM THE PICTURE BELOW

CABLE TYPE

CABLE LENGTH (mm)	N/A
CABLE TOLERANCE (mm)	N/A
WIRE GAUGE (AWG)	N/A
CONDUCTORS	4
HANK DIMENSION (mm)	N/A
CABLE / CONNECTOR OVERMOLD COLOR	N/A
FERRITE TYPE AND DIMENSION	None
FERRITE NUMBER OF TURNS (Definition)	N/A
FERRITE DIMENSION FROM STRAIN RELIEF	N/A
FERRITE DIMENSION FROM PLUG	N/A
PLUG TYPE	Molex 2.54mm Pitch 4-Pin Header PN: 22-11-2042 MATES W/ PN: 22-01-2047 or Equivalent

OVERMOLDED No

Pins 1 and 2: +V,

CONNECTOR PIN OUT

Pins 3 and 4: -V



Optional wiring kits available:

PN/Ordering No	Length	End A	End B
XHP410070M7XHP4(R)	70	JST XHP-4	JST XHP-4
XHP410070M7MLX3(R)	70	JST XHP-4	Molex 09-93-0300

Custom lengths, construction, cable types, ferrites, filters, and termination available upon request.

ADDITIONAL OUTPUT PLUG OPTIONS ARE AVAILABLE AT <https://www.globtek.com/connectors/>

STANDARD PLUGS AND CONNECTORS CAN BE SEEN ONLINE AT <https://www.globtek.com/connectors/>

CALCULATE VOLTAGE REGULATION/DROP WITH OUR ONLINE CALCULATOR: <https://en.globtek.com/output-cable-regulation-calculator/>

<p>GlobTek, Inc. www.globtek.com 186 Veterans Drive, Northvale, NJ 07647 Tel. (201) 784-1000 Fax (201) 784-0111</p>	<p>Drawing Title: GTM43007-C6024-FW, ICT / ITE / Medical Power Supply, Efficiency Level: N/A, Case Color/Style: GlobTek Black, Open Frame/Internal, Regulated Switchmode AC-DC Power Supply AC Adaptor, Input Rating: 100-240V~, 50-60 Hz, Molex Header (or equal) , Output Rating: 60W, 24.0V@2.5A, Output Configuration: N/A mm, N/A/4 Cond. , Molex 2.54mm Pitch 4-Pin Header PN: 22-11-2042 MATES W/ PN: 22-01-2047 or Equivalent, Ferrite: None, N/A, GT Cord # C0127, Pin Out: Pins 1 and 2: +V, Pins 3 and 4: -V, Blades/Input Cord: Not Applicable, Approvals: CB 62368; ETL 62368; EAC; UKCA; Conforms to 62368-1; CCC; Book 60601; CB 60601-1 2MOPP (6W max); CE; China RoHS; Double Insulation; RoHS; Ukraine; WEEE; CE; FCC; Fuse 60335; CB 60950; CB EN/IEC 60335-1; Fuse 60335; Level V; LPS 60950; WDaE; cETLus ES60601; cETLus; cETLus 60601-1 3rd;</p>
	<p>Model No. GTM43007-C6024-FW</p>
	<p>Part No./Ordering No. GTM43007-C6024-FW(R) Rev B</p>

OUTPUT CONNECTOR HOOK UP

TO ADDRESS SYSTEM-LEVEL EMI CONCERNS, FERRITE CHOKES/BEADS MAY BE ADDED/REVISED UPON REQUEST. A SAMPLE KIT OF GLOBTEK'S STANDARD FERRITES IS AVAILABLE UNDER GLOBTEK P/N: EMI-MITIGATION-KIT1

FOR ADDITIONAL INFORMATION, PLEASE READ OUR WHITE PAPER AT:

<https://en.globtek.com/technical-articles/ferrite-kit-radiated-emi-suppression-kit-for-globtek-power-supplies-cable-assemblies>

GloTek, Inc. www.globtek.com 186 Veterans Drive, Northvale, NJ 07647 Tel. (201) 784-1000 Fax (201) 784-0111	Drawing Title: GTM43007-C6024-FW, ICT / ITE / Medical Power Supply, Efficiency Level: N/A, Case Color/Style: GlobTek Black, Open Frame/Internal, Regulated Switchmode AC-DC Power Supply AC Adaptor, Input Rating: 100-240V~, 50-60 Hz, Molex Header (or equal) , Output Rating: 60W, 24.0V@2.5A, Output Configuration: N/A mm, N/A/4 Cond. , Molex 2.54mm Pitch 4-Pin Header PN: 22-11-2042 MATES W/ PN: 22-01-2047 or Equivalent, Ferrite: None, N/A, GT Cord # C0127, Pin Out: Pins 1 and 2: +V, Pins 3 and 4: -V, Blades/Input Cord: Not Applicable, Approvals: CB 62368; ETL 62368; EAC; UKCA; Conforms to 62368-1; CCC; Book 60601; CB 60601-1 2MOPP (6W max); CE; China RoHS; Double Insulation; RoHS; Ukraine; WEEE; CE; FCC; Fuse 60335; CB 60950; CB EN/IEC 60335-1; Fuse 60335; Level V; LPS 60950; WDaE; cETLus ES60601; cETLus; cETLus 60601-1 3rd;	
	Model No. GTM43007-C6024-FW	
	Part No./Ordering No. GTM43007-C6024-FW(R)	Rev B

LABEL:L-1186

LABEL P/N	Standard GT
MATERIAL	Flat Thermal Transfer, Imprintable, Polyester Label and/or Pad Printed and/or Molded, and/or Laser Engraved in the case
BACKGROUND COLOR	Black if housing is Black, White or Silver if housing is White or Gray.
TEXT COLOR	White or Silver if label is Black Background for Black housing. Black if label is White or Silver background and Housing is White or Gray.
SPECIAL BARCODE LABEL MATERIAL	No

Below is the minimum information which will appear on the label. NOTE: in the logo area additional/actual positioning of symbols and text is subjected to change as per agency updates/requirements or additional model approvals become available. Regulatory certifications/label markings may be in logo area on the label or molded into the case housing outside the label area. Information will be shown via label and/or pad printed and/or molded and/or laser engraved in the case. * Date code markings at GlobTek option

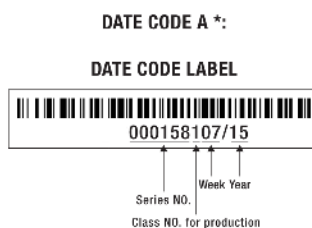

or
DATE CODE B *:
WWYY
WW = WEEK
YY = YEAR

A=ICT / ITE / Medical Power Supply
B=P/N: (料号) GTM43007-C6024-FW(R)
C=Model (型号) GTM43007-C6024-FW
D=Input (输入)100-240V~, 50-60 Hz, 1.5A
E=Output (输出)24.0 V 2.5 A, 60.00W

GlobTek, Inc. www.globtek.com 186 Veterans Drive, Northvale, NJ 07647 Tel. (201) 784-1000 Fax (201) 784-0111	Drawing Title: GTM43007-C6024-FW, ICT / ITE / Medical Power Supply, Efficiency Level: N/A, Case Color/Style: GlobTek Black, Open Frame/Internal, Regulated Switchmode AC-DC Power Supply AC Adaptor, Input Rating: 100-240V~, 50-60 Hz, Molex Header (or equal) , Output Rating: 60W, 24.0V@2.5A, Output Configuration: N/A mm, N/A/4 Cond. , Molex 2.54mm Pitch 4-Pin Header PN: 22-11-2042 MATES W/ PN: 22-01-2047 or Equivalent, Ferrite: None, N/A, GT Cord # C0127, Pin Out: Pins 1 and 2: +V, Pins 3 and 4: -V, Blades/Input Cord: Not Applicable, Approvals: CB 62368; ETL 62368; EAC; UKCA; Conforms to 62368-1; CCC; Book 60601; CB 60601-1 2MOPP (6W max); CE; China RoHS; Double Insulation; RoHS; Ukraine; WEEE; CE; FCC; Fuse 60335; CB 60950; CB EN/IEC 60335-1; Fuse 60335; Level V; LPS 60950; WDaE; cETLus ES60601; cETLus; cETLus 60601-1 3rd;	
	Model No. GTM43007-C6024-FW	
	Part No./Ordering No. GTM43007-C6024-FW(R)	Rev B

AGENCY ONLINE DOCUMENTS	http://www.globtek.info/certs/GTM43007/
CE EC-Declaration for Medical	http://globtek.force.com/models/ec_declaration_product?id=01ta0000007dRIW&m=1
CE EC-Declaration for Industrial/Commercial/ITE	http://globtek.force.com/models/ec_declaration_product?id=01ta0000007dRIW&i=3
CE EC-Declaration for Household	Contact GlobTek for more information
UKCA-Declaration for Medical	http://globtek.force.com/models/ukca_declaration_product?id=01ta0000007dRIW&m=1
UKCA-Declaration for Industrial/Commercial/ITE	http://globtek.force.com/models/ukca_declaration_product?id=01ta0000007dRIW&i=3
UKCA-Declaration for Household	Contact GlobTek for more information
Morocco SDoC Declaration	https://globtek.secure.force.com/models/Morocco_SDoC_Declaration?id=a0Oa000000MgcAQEAZ
RoHS/RoHS3 Declaration	https://www.globtek.com/pdf/rohs_cert/01ta0000007dRIWAA2
REACH Declaration	https://www.globtek.com/pdf/iso_certificates/REACH.pdf
Conflict Minerals Declaration	https://www.globtek.com/pdf/conflict-minerals.pdf
Prop 65 Statement	https://en.globtek.com/prop-65-statement.pdf

IPXY rating is based on 3rd party testing and customers should check suitability and test system level IPXY rating before ordering.

Regulatory Certifications/Label Markings

Below follows a link to the latest regulatory certifications and marks for this specific product. National standards as well as certification schemes are constantly changing and so is the set of certification marks and symbols applicable to this product. Various standards, marks and symbols, and certificates are subject to change at any time without notice.

Additional standards or unique country certifications are available upon request. Please contact Globtek to request a quotation.

LATEST PRODUCT/MODEL CERTIFICATIONS: <https://www.globtek.com/datasheet/w71028>

AGENCY ONLINE DOCUMENTS <http://www.globtek.info/certs/GTM43007/>



(F1) Class II / Double Insulated

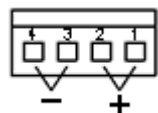

Pins 1 and 2: +V,
Pins 3 and 4: -V

GlobTek, Inc. www.globtek.com 186 Veterans Drive, Northvale, NJ 07647 Tel. (201) 784-1000 Fax (201) 784-0111	Drawing Title: GTM43007-C6024-FW, ICT / ITE / Medical Power Supply, Efficiency Level: N/A, Case Color/Style: GlobTek Black, Open Frame/Internal, Regulated Switchmode AC-DC Power Supply AC Adaptor, Input Rating: 100-240V~, 50-60 Hz, Molex Header (or equal) , Output Rating: 60W, 24.0V@2.5A, Output Configuration: N/A mm, N/A/4 Cond. , Molex 2.54mm Pitch 4-Pin Header PN: 22-11-2042 MATES W/ PN: 22-01-2047 or Equivalent, Ferrite: None, N/A, GT Cord # C0127, Pin Out: Pins 1 and 2: +V, Pins 3 and 4: -V, Blades/Input Cord: Not Applicable, Approvals: CB 62368; ETL 62368; EAC; UKCA; Conforms to 62368-1; CCC; Book 60601; CB 60601-1 2MOPP (6W max); CE; China RoHS; Double Insulation; RoHS; Ukraine; WEEE; CE; FCC; Fuse 60335; CB 60950; CB EN/IEC 60335-1; Fuse 60335; Level V; LPS 60950; WDaE; cETLus ES60601; cETLus; cETLus 60601-1 3rd;	
	Model No. GTM43007-C6024-FW	
	Part No./Ordering No. GTM43007-C6024-FW(R)	Rev B

PACKAGING

Packing Spec P/N

Box Qty	60
Gift Box Size (mm)	147*100*33
Gift Box Color	White
Master Carton Size (mm)	455 x 415 x 210
Master Carton Cubic Volume (m³)	0.04
Master GW (Kg)	kg
BLADES INCLUDED	N/A: Not Applicable
BLADE/CORD INSTALLED	N/A: Not Applicable
USER MANUAL*	
USER MANUAL WEB LINK	

* This specification sheet is considered the user manual for all applications. It is expected that the buyer of this product will use it to formulate their own user manual for their end product and a user manual specifically for the power adapter is not usually required. If a user manual is not specifically listed above then none will be provided with this unit.

<p>GlobTek, Inc. www.globtek.com 186 Veterans Drive, Northvale, NJ 07647 Tel. (201) 784-1000 Fax (201) 784-0111</p>	<p>Drawing Title: GTM43007-C6024-FW, ICT / ITE / Medical Power Supply, Efficiency Level: N/A, Case Color/Style: GlobTek Black, Open Frame/Internal, Regulated Switchmode AC-DC Power Supply AC Adaptor, Input Rating: 100-240V~, 50-60 Hz, Molex Header (or equal) , Output Rating: 60W, 24.0V@2.5A, Output Configuration: N/A mm, N/A/4 Cond. , Molex 2.54mm Pitch 4-Pin Header PN: 22-11-2042 MATES W/ PN: 22-01-2047 or Equivalent, Ferrite: None, N/A, GT Cord # C0127, Pin Out: Pins 1 and 2: +V, Pins 3 and 4: -V, Blades/Input Cord: Not Applicable, Approvals: CB 62368; ETL 62368; EAC; UKCA; Conforms to 62368-1; CCC; Book 60601; CB 60601-1 2MOPP (6W max); CE; China RoHS; Double Insulation; RoHS; Ukraine; WEEE; CE; FCC; Fuse 60335; CB 60950; CB EN/IEC 60335-1; Fuse 60335; Level V; LPS 60950; WDaE; cETLus ES60601; cETLus; cETLus 60601-1 3rd;</p>
<p>Model No. GTM43007-C6024-FW</p>	
<p>Part No./Ordering No. GTM43007-C6024-FW(R)</p>	<p>Rev B</p>

INSTRUCTIONS TO THE OEM SYSTEMS ENGINEER

It is the responsibility of the OEM systems engineer to provide the end system user instructions and warnings for the use of this product in the end system.

If an input cord is required for this product, AC Mains voltage should be provided to the power supply by a power supply cord approved to the national standards of the country in which it will be used.

This product is not designed to be repaired. No serviceable parts inside. A blown internal fuse is an indication of catastrophic failure of circuit component(s). If a Failure Analysis is required for a failed power supply/battery charger, please return the damaged unit to GlobTek for an accurate determination of the root cause of the failure.

EMC Compliance of the complete OEM product, including the GlobTek power supply/battery charger needs to be verified by the OEM systems engineer.

INSTRUCTION SHEET

N/A

<p>GlobTek, Inc. www.globtek.com 186 Veterans Drive, Northvale, NJ 07647 Tel. (201) 784-1000 Fax (201) 784-0111</p>	<p>Drawing Title: GTM43007-C6024-FW, ICT / ITE / Medical Power Supply, Efficiency Level: N/A, Case Color/Style: GlobTek Black, Open Frame/Internal, Regulated Switchmode AC-DC Power Supply AC Adaptor, Input Rating: 100-240V~, 50-60 Hz, Molex Header (or equal) , Output Rating: 60W, 24.0V@2.5A, Output Configuration: N/A mm, N/A/4 Cond. , Molex 2.54mm Pitch 4-Pin Header PN: 22-11-2042 MATES W/ PN: 22-01-2047 or Equivalent, Ferrite: None, N/A, GT Cord # C0127, Pin Out: Pins 1 and 2: +V, Pins 3 and 4: -V, Blades/Input Cord: Not Applicable, Approvals: CB 62368; ETL 62368; EAC; UKCA; Conforms to 62368-1; CCC; Book 60601; CB 60601-1 2MOPP (6W max); CE; China RoHS; Double Insulation; RoHS; Ukraine; WEEE; CE; FCC; Fuse 60335; CB 60950; CB EN/IEC 60335-1; Fuse 60335; Level V; LPS 60950; WDaE; cETLus ES60601; cETLus; cETLus 60601-1 3rd;</p>
	<p>Model No. GTM43007-C6024-FW</p>
	<p>Part No./Ordering No. GTM43007-C6024-FW(R) Rev B</p>

