

5A Low drop positive voltage regulator adjustable and fixed

Feature summary

- Typical dropout 1.3V (at 5A)
- Three terminal adjustable or fixed output voltage 1.5V, 1.8V, 2.5V, 2.85V, 3.3V, 3.6V, 5V, 8V, 9V, 12V.
- Guaranteed output current up to 5A
- Output tolerance $\pm 1\%$ at 25°C and $\pm 2\%$ in full temperature range
- Internal power and thermal limit
- Wide operating temperature range -40°C to 125°C
- Package available: TO-220, D²PAK, D²PAK/A
- Pinout compatibility with standard adjustable VREG

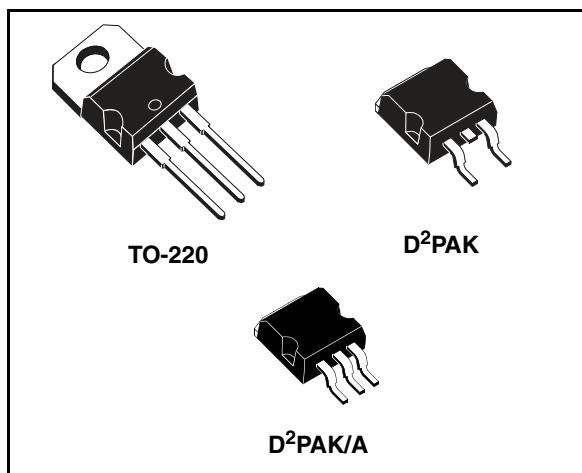

Description

The LD1084 is a LOW DROP Voltage Regulator able to provide up to 5A of Output Current. Dropout is guaranteed at a maximum of 1.5V at the maximum output current, decreasing at lower loads. The LD1084 is pin to pin compatible with the older 3-terminal adjustable regulators, but has better performances in term of drop and output tolerance.

A 2.85V output version is suitable for SCSI-2 active termination. Unlike PNP regulators, where a part of the output current is wasted as quiescent current, the LD1084 quiescent current flows into the load, so increase efficiency. Only a 10 μ F minimum capacitor is need for stability.

The device is supplied in TO-220, D²PAK and D²PAK/A. On chip trimming allows the regulator to reach a very tight output voltage tolerance, within $\pm 1\%$ at 25°C.

Schematic diagram

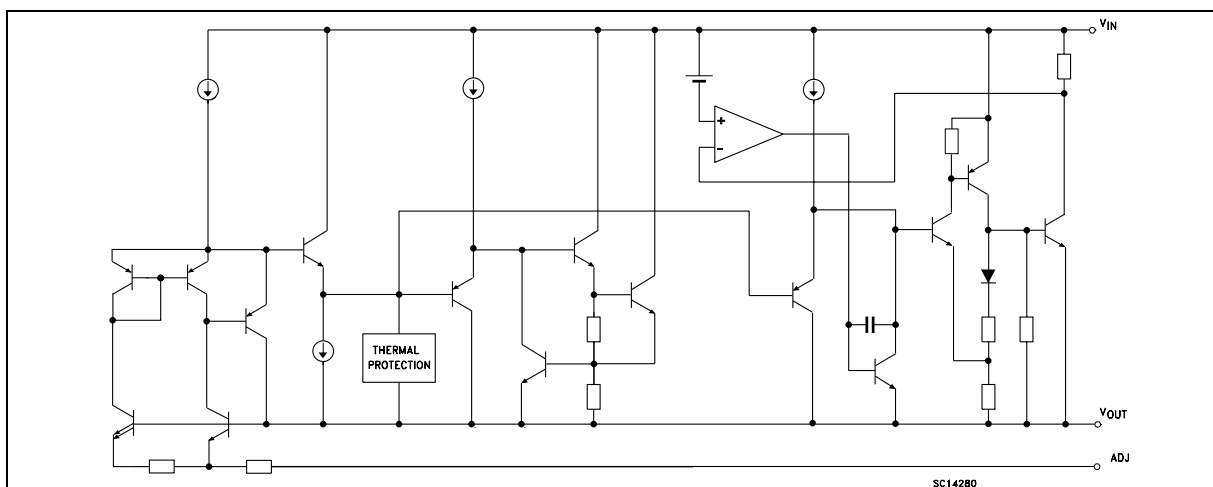

Contents

1	Pin configuration	3
2	Maximum ratings	4
3	Schematic application	5
4	Electrical characteristics	6
5	Typical application	17
6	Package mechanical data	22
7	Order code	27
8	Revision history	28

1 Pin configuration

Figure 1. Pin connections (top view)

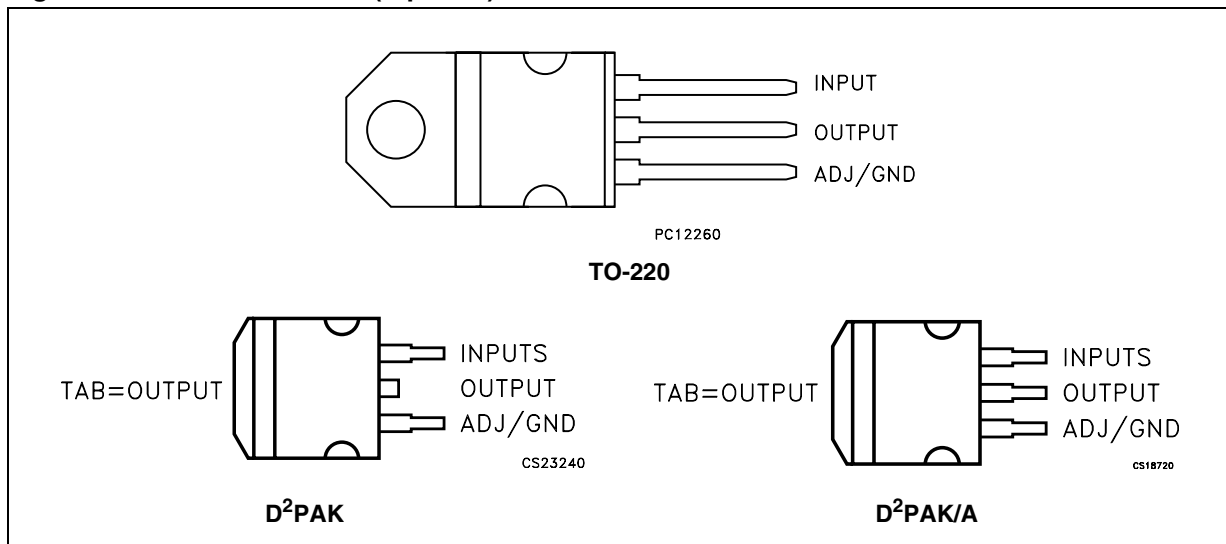

2 Maximum ratings

Table 1. Absolute maximum ratings

Symbol	Parameter	Value	Unit
V_I	DC Input voltage	30	V
I_O	Output current	Internally Limited	mA
P_D	Power dissipation	Internally Limited	mW
T_{STG}	Storage temperature range	-55 to +150	°C
T_{OP}	Operating junction temperature range	-40 to +125	°C

Note: Absolute Maximum Ratings are those values beyond which damage to the device may occur. Functional operation under these condition is not implied

Table 2. Thermal Data

Symbol	Parameter	TO-220	D ² PAK	Unit
R_{thJC}	Thermal resistance junction-case	3	3	°C/W
R_{thJA}	Thermal resistance junction-ambient	50	62.5	°C/W

3 Schematic application

Figure 2. Application circuit

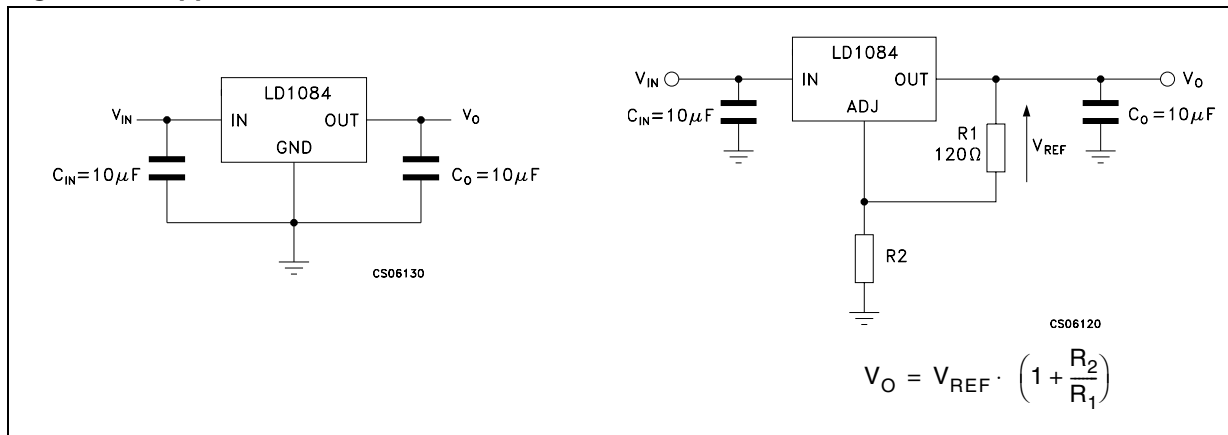

4 Electrical characteristics

Table 3. Electrical characteristics of LD1084#15
($V_I=4.5V$, $C_I = C_O = 10\mu F$, $T_A = -40$ to $125^\circ C$, unless otherwise specified).

Symbol	Parameter	Test	Min.	Typ.	Max.	Unit
V_O	Output voltage ⁽¹⁾	$I_O = 0$ mA, $T_J = 25^\circ C$	1.485	1.5	1.515	V
		$I_O = 0$ to 5A, $V_I = 3.1$ to 30V	1.47	1.5	1.53	V
ΔV_O	Line Regulation	$I_O = 0$ mA, $V_I = 3.1$ to 18V, $T_J = 25^\circ C$		0.5	6	mV
		$I_O = 0$ mA, $V_I = 3.1$ to 15V		0.1	6	mV
ΔV_O	Load Regulation	$I_O = 0$ to 5A, $T_J = 25^\circ C$		3	15	mV
		$I_O = 0$ to 5A		7	20	mV
V_d	Dropout Voltage	$I_O = 5$ A		1.3	1.5	V
I_q	Quiescent Current	$V_I \leq 30V$		5	10	mA
I_{sc}	Short Circuit Current	$V_I - V_O = 5V$	5.5	6.5		A
		$V_I - V_O = 25V$	0.5	0.7		A
	Thermal Regulation	$T_A = 25^\circ C$, 30ms pulse		0.003	0.015	%/W
SVR	Supply Voltage Rejection	$f = 120$ Hz, $C_O = 25\mu F$, $I_O = 5A$ $V_I = 6.8 \pm 3V$	60	75		dB
eN	RMS Output Noise Voltage (% of V_O)	$T_A = 25^\circ C$, $f=10Hz$ to 10KHz		0.003		%
S	Temperature Stability			0.5		%
S	Long Term Stability	$T_A = 125^\circ C$, 1000Hrs		0.5		%

1. See short-circuit current curve for available output current at fixed dropout.

Table 4. Electrical characteristics of LD1084#18(V_I=4.8V, C_I = C_O =10μF, T_A = -40 to 125°C, unless otherwise specified).

Symbol	Parameter	Test	Min.	Typ.	Max.	Unit
V _O	Output voltage ⁽¹⁾	I _O = 0 mA, T _J = 25°C	1.782	1.8	1.818	V
		I _O = 0 to 5A, V _I = 3.4 to 30V	1.764	1.8	1.836	V
ΔV _O	Line Regulation	I _O = 0 mA, V _I = 3.4 to 18V T _J = 25°C		0.5	6	mV
		I _O = 0 mA, V _I = 3.4 to 15V		0.1	6	mV
ΔV _O	Load Regulation	I _O = 0 to 5A, T _J = 25°C		3	15	mV
		I _O = 0 to 35A		7	20	mV
V _d	Dropout Voltage	I _O = 5 A		1.3	1.5	V
I _q	Quiescent Current	V _I ≤30V		5	10	mA
I _{sc}	Short Circuit Current	V _I - V _O = 5V	5.5	6.5		A
		V _I - V _O = 25V	0.5	0.7		A
	Thermal Regulation	T _A = 25°C, 30ms pulse		0.003	0.015	%/W
SVR	Supply Voltage Rejection	f = 120 Hz, C _O = 25μF, I _O = 5A V _I = 6.8 ± 3V	60	75		dB
eN	RMS Output Noise Voltage (% of V _O)	T _A = 25°C, f =10Hz to 10KHz		0.003		%
S	Temperature Stability			0.5		%
S	Long Term Stability	T _A = 125°C, 1000Hrs		0.5		%

1. See short-circuit current curve for available output current at fixed dropout.

Table 5. Electrical characteristics of LD1084#25(V_I=5.5V, C_I = C_O =10μF, T_A = -40 to 125°C, unless otherwise specified).

Symbol	Parameter	Test	Min.	Typ.	Max.	Unit
V _O	Output voltage ⁽¹⁾	I _O = 0 mA, T _J = 25°C	2.475	2.5	2.525	V
		I _O = 0 to 5A, V _I = 4.1 to 30V	2.45	2.5	2.55	V
ΔV _O	Line regulation	I _O = 0 mA, V _I = 4.1 to 18V, T _J = 25°C		0.5	6	mV
		I _O = 0 mA, V _I = 4.1 to 18V		0.1	6	mV
ΔV _O	Load regulation	I _O = 0 to 5A, T _J = 25°C		3	15	mV
		I _O = 0 to 5A		7	20	mV
V _d	Dropout voltage	I _O = 5A		1.3	1.5	V
I _q	Quiescent current	V _I ≤ 30V		5	10	mA
I _{sc}	Short circuit current	V _I - V _O = 5V	5.5	6.5		A
		V _I - V _O = 25V	0.5	0.7		A
	Thermal regulation	T _A = 25°C, 30ms pulse		0.003	0.015	%/W
SVR	Supply voltage rejection	f = 120 Hz, C _O = 25μF, I _O = 5A V _I = 7.5 ± 3V	60	72		dB
eN	RMS Output noise voltage (% of V _O)	T _A = 25°C, f = 10Hz to 10KHz		0.003		%
S	Temperature stability			0.5		%
S	Long term stability	T _A = 125°C, 1000Hrs		0.5		%

1. See short-circuit current curve for available output current at fixed dropout.

Table 6. Electrical characteristics of LD1084#285
 ($V_I=5.85V$, $C_I = C_O = 10\mu F$, $T_A = -40$ to $125^\circ C$, unless otherwise specified).

Symbol	Parameter	Test	Min.	Typ.	Max.	Unit
V_O	Output voltage ⁽¹⁾	$I_O = 0$ mA, $T_J = 25^\circ C$	2.821	2.85	2.879	V
		$I_O = 0$ to 5A, $V_I = 4.5$ to 30V	2.793	2.85	2.907	V
ΔV_O	Line regulation	$I_O = 0$ mA, $V_I = 4.5$ to 18V, $T_J = 25^\circ C$		0.5	6	mV
		$I_O = 0$ mA, $V_I = 4.5$ to 18V		0.1	6	mV
ΔV_O	Load regulation	$I_O = 0$ to 5A, $T_J = 25^\circ C$		3	15	mV
		$I_O = 0$ to 5A		7	20	mV
V_d	Dropout voltage	$I_O = 5A$		1.3	1.5	V
I_q	Quiescent current	$V_I \leq 30V$		5	10	mA
I_{sc}	Short circuit current	$V_I - V_O = 5V$	5.5	6.5		A
		$V_I - V_O = 25V$	0.5	0.7		A
	Thermal regulation	$T_A = 25^\circ C$, 30ms pulse		0.003	0.015	%/W
SVR	Supply voltage rejection	$f = 120$ Hz, $C_O = 25\mu F$, $I_O = 5A$ $V_I = 7.85 \pm 3V$	60	72		dB
eN	RMS Output noise voltage (% of V_O)	$T_A = 25^\circ C$, $f = 10$ Hz to 10KHz		0.003		%
S	Temperature stability			0.5		%
S	Long term stability	$T_A = 125^\circ C$, 1000Hrs		0.5		%

1. See short-circuit current curve for available output current at fixed dropout.

Table 7. Electrical characteristics of LD1084#33(V_I=6.3V, C_I = C_O =10μF, T_A = -40 to 125°C, unless otherwise specified).

Symbol	Parameter	Test	Min.	Typ.	Max.	Unit
V _O	Output voltage ⁽¹⁾	I _O = 0 mA, T _J = 25°C	3.267	3.3	3.333	V
		I _O = 0 to 5A, V _I = 4.9 to 30V	3.234	3.35	3.366	V
ΔV _O	Line regulation	I _O = 0 mA, V _I = 4.9 to 18V, T _J = 25°C		0.5	6	mV
		I _O = 0 mA, V _I = 4.9 to 18V		0.1	6	mV
ΔV _O	Load regulation	I _O = 0 to 5A, T _J = 25°C		3	15	mV
		I _O = 0 to 5A		7	20	mV
V _d	Dropout voltage	I _O = 5A		1.3	1.5	V
I _q	Quiescent current	V _I ≤ 30V		5	10	mA
I _{sc}	Short circuit current	V _I - V _O = 5V	5.5	6.5		A
		V _I - V _O = 25V	0.5	0.7		A
	Thermal regulation	T _A = 25°C, 30ms pulse		0.003	0.015	%/W
SVR	Supply voltage rejection	f = 120 Hz, C _O = 25μF, I _O = 5A V _I = 8.3 ± 3V	60	72		dB
eN	RMS Output noise voltage (% of V _O)	T _A = 25°C, f = 10Hz to 10KHz		0.003		%
S	Temperature stability			0.5		%
S	Long term stability	T _A = 125°C, 1000Hrs		0.5		%

1. See short-circuit current curve for available output current at fixed dropout.

Table 8. Electrical characteristics of LD1084#36(V_I=6.6V, C_I = C_O =10μF, T_A = -40 to 125°C, unless otherwise specified).

Symbol	Parameter	Test	Min.	Typ.	Max.	Unit
V _O	Output voltage ⁽¹⁾	I _O = 0 mA, T _J = 25°C	3.564	3.6	3.636	V
		I _O = 0 to 5A, V _I = 5.2 to 30V	3.528	3.6	3.672	V
ΔV _O	Line regulation	I _O = 0 mA, V _I = 5.2 to 18V, T _J = 25°C		0.5	10	mV
		I _O = 0 mA, V _I = 5.2 to 18V		0.1	10	mV
ΔV _O	Load regulation	I _O = 0 to 5A, T _J = 25°C		3	15	mV
		I _O = 0 to 5A		7	20	mV
V _d	Dropout voltage	I _O = 5A		1.3	1.5	V
I _q	Quiescent current	V _I ≤ 30V		5	10	mA
I _{sc}	Short circuit current	V _I - V _O = 5V	5.5	6.5		A
		V _I - V _O = 25V	0.5	0.7		A
	Thermal regulation	T _A = 25°C, 30ms pulse		0.003	0.015	%/W
SVR	Supply voltage rejection	f = 120 Hz, C _O = 25μF, I _O = 5A V _I = 8.6 ± 3V	60	72		dB
eN	RMS Output noise voltage (% of V _O)	T _A = 25°C, f = 10Hz to 10KHz		0.003		%
S	Temperature stability			0.5		%
S	Long term stability	T _A = 125°C, 1000Hrs		0.5		%

1. See short-circuit current curve for available output current at fixed dropout.

Table 9. Electrical characteristics of LD1084#5
 ($V_I=8V$, $C_I = C_O = 10\mu F$, $T_A = -40$ to $125^\circ C$, unless otherwise specified).

Symbol	Parameter	Test	Min.	Typ.	Max.	Unit
V_O	Output voltage ⁽¹⁾	$I_O = 0$ mA, $T_J = 25^\circ C$	4.95	5	5.05	V
		$I_O = 0$ to 5A, $V_I = 6.6$ to 30V	4.9	5	5.1	V
ΔV_O	Line regulation	$I_O = 0$ mA, $V_I = 6.6$ to 20V, $T_J = 25^\circ C$		0.5	10	mV
		$I_O = 0$ mA, $V_I = 6.6$ to 20V		1	10	mV
ΔV_O	Load regulation	$I_O = 0$ to 5A, $T_J = 25^\circ C$		5	20	mV
		$I_O = 0$ to 5A		10	35	mV
V_d	Dropout voltage	$I_O = 5A$		1.3	1.5	V
I_q	Quiescent current	$V_I \leq 30V$		5	10	mA
I_{sc}	Short circuit current	$V_I - V_O = 5V$	5.5	6.5		A
		$V_I - V_O = 25V$	0.5	0.7		A
	Thermal regulation	$T_A = 25^\circ C$, 30ms pulse		0.003	0.015	%/W
SVR	Supply voltage rejection	$f = 120$ Hz, $C_O = 25\mu F$, $I_O = 5A$ $V_I = 10 \pm 3V$	60	72		dB
eN	RMS Output noise voltage (% of V_O)	$T_A = 25^\circ C$, $f = 10Hz$ to 10KHz		0.003		%
S	Temperature stability			0.5		%
S	Long term stability	$T_A = 125^\circ C$, 1000Hrs		0.5		%

1. See short-circuit current curve for available output current at fixed dropout.

Table 10. Electrical characteristics of LD1084#8(V_I=11V, C_I = C_O =10μF, T_A = -40 to 125°C, unless otherwise specified).

Symbol	Parameter	Test	Min.	Typ.	Max.	Unit
V _O	Output voltage ⁽¹⁾	I _O = 0 mA, T _J = 25°C	7.92	8	8.08	V
		I _O = 0 to 5A, V _I = 9.6 to 30V	7.84	8	8.16	V
ΔV _O	Line regulation	I _O = 0 mA, V _I = 9.6 to 20V, T _J = 25°C		1	18	mV
		I _O = 0 mA, V _I = 9.6 to 20V		2	18	mV
ΔV _O	Load regulation	I _O = 0 to 5A, T _J = 25°C		8	30	mV
		I _O = 0 to 5A		12	60	mV
V _d	Dropout voltage	I _O = 5A		1.3	1.5	V
I _q	Quiescent current	V _I ≤ 30V		5	10	mA
I _{sc}	Short circuit current	V _I - V _O = 5V	5.5	6.5		A
		V _I - V _O = 25V	0.5	0.7		A
	Thermal regulation	T _A = 25°C, 30ms pulse		0.003	0.015	%/W
SVR	Supply voltage rejection	f = 120 Hz, C _O = 25μF, I _O = 5A V _I = 13 ± 3V	54	71		dB
eN	RMS Output noise voltage (% of V _O)	T _A = 25°C, f = 10Hz to 10KHz		0.003		%
S	Temperature stability			0.5		%
S	Long term stability	T _A = 125°C, 1000Hrs		0.5		%

1. See short-circuit current curve for available output current at fixed dropout.

Table 11. Electrical characteristics of LD1084#9(V_I=12V, C_I = C_O =10μF, T_A = -40 to 125°C, unless otherwise specified).

Symbol	Parameter	Test	Min.	Typ.	Max.	Unit
V _O	Output voltage ⁽¹⁾	I _O = 0 mA, T _J = 25°C	8.91	9	9.09	V
		I _O = 0 to 3A, V _I = 10.6 to 30V	8.82	9	9.18	V
ΔV _O	Line regulation	I _O = 0 mA, V _I = 10.6 to 20V, T _J =25°C		1	20	mV
		I _O = 0 mA, V _I = 10.6 to 20V		2	20	mV
ΔV _O	Load regulation	I _O = 0 to 5A, T _J = 25°C		8	30	mV
		I _O = 0 to 5A		12	60	mV
V _d	Dropout voltage	I _O = 5A		1.3	1.5	V
I _q	Quiescent current	V _I ≤ 30V		5	10	mA
I _{sc}	Short circuit current	V _I - V _O = 5V	5.5	6.5		A
		V _I - V _O = 25V	0.5	0.7		A
	Thermal regulation	T _A = 25°C, 30ms pulse		0.003	0.015	%/W
SVR	Supply voltage rejection	f = 120 Hz, C _O = 25μF, I _O = 5A V _I = 14 ± 3V	54	70		dB
eN	RMS Output noise voltage (% of V _O)	T _A = 25°C, f = 10Hz to 10KHz		0.003		%
S	Temperature stability			0.5		%
S	Long term stability	T _A = 125°C, 1000Hrs		0.5		%

1. See short-circuit current curve for available output current at fixed dropout.

Table 12. Electrical characteristics of LD1084#12(V_I=15V, C_I = C_O =10μF, T_A = -40 to 125°C, unless otherwise specified).

Symbol	Parameter	Test	Min.	Typ.	Max.	Unit
V _O	Output voltage ⁽¹⁾	I _O = 0 mA, T _J = 25°C	11.88	12	12.12	V
		I _O = 0 to 5A, V _I = 13.6 to 30V	11.76	12	12.24	V
ΔV _O	Line regulation	I _O = 0 mA, V _I = 13.6 to 25V, T _J = 25°C		2	25	mV
		I _O = 0 mA, V _I = 13.6 to 25V		4	25	mV
ΔV _O	Load regulation	I _O = 0 to 5A, T _J = 25°C		12	36	mV
		I _O = 0 to 5A		24	72	mV
V _d	Dropout voltage	I _O = 5A		1.3	1.5	V
I _q	Quiescent current	V _I ≤ 30V		5	10	mA
I _{sc}	Short circuit current	V _I - V _O = 5V	5.5	6.5		A
		V _I - V _O = 25V	0.5	0.7		A
	Thermal regulation	T _A = 25°C, 30ms pulse		0.003	0.015	%/W
SVR	Supply voltage rejection	f = 120 Hz, C _O = 25μF, I _O = 5A V _I = 17 ± 3V	54	66		dB
eN	RMS Output noise voltage (% of V _O)	T _A = 25°C, f = 10Hz to 10KHz		0.003		%
S	Temperature stability			0.5		%
S	Long term stability	T _A = 125°C, 1000Hrs		0.5		%

1. See short-circuit current curve for available output current at fixed dropout.

Table 13. Electrical characteristics of LD1084(V_I=4.25V, C_I = C_O =10μF, T_A = -40 to 125°C, unless otherwise specified).

Symbol	Parameter	Test	Min.	Typ.	Max.	Unit
V _O	Output voltage ⁽¹⁾	I _O = 10mA T _J = 25°C	1.237	1.25	1.263	V
		I _O = 10mA to 3A, V _I = 2.85 to 30V	1.225	1.25	1.275	V
ΔV _O	Line Regulation	I _O = 10mA, V _I = 2.85 to 16.5V, T _J = 25°C		0.015	0.2	%
		I _O = 10mA, V _I = 2.85 to 16.5V		0.035	0.2	%
ΔV _O	Load Regulation	I _O = 10mA to 5A, T _J = 25°C		0.1	0.3	%
		I _O = 0 to 5A		0.2	0.4	%
V _d	Dropout Voltage	I _O = 5A		1.3	1.5	V
I _{O(min)}	Minimum Load Current	V _I = 30V		3	10	mA
I _{sc}	Short Circuit Current	V _I - V _O = 5V	5.5	6.5		A
		V _I - V _O = 25V	0.5	0.7		A
	Thermal Regulation	T _A = 25°C, 30ms pulse		0.003	0.015	%/W
SVR	Supply Voltage Rejection	f = 120 Hz, C _O = 25μF, C _{ADJ} = 25 μF, I _O = 5A, V _I = 6.25 ± 3V	60	72		dB
I _{ADJ}	Adjust Pin Current	V _I = 4.25V, I _O = 10 mA		55	120	μA
ΔI _{ADJ}	Adjust Pin Current Change ⁽¹⁾	I _O = 10mA to 5A, V _I = 2.85 to 16.5V		0.2	5	μA
eN	RMS Output Noise Voltage (% of V _O)	T _A = 25°C, f = 10Hz to 10KHz		0.003		%
S	Temperature Stability			0.5		%
S	Long Term Stability	T _A = 125°C, 1000Hrs		0.5		%

1. See short-circuit current curve for available output current at fixed dropout.

5 Typical application

Unless otherwise specified $T_J = 25^\circ\text{C}$, $C_1 = 10\mu\text{F}$ (tant.), $C_O = 22\mu\text{F}$ (tant.)

Figure 3. Short circuit current vs dropout voltage

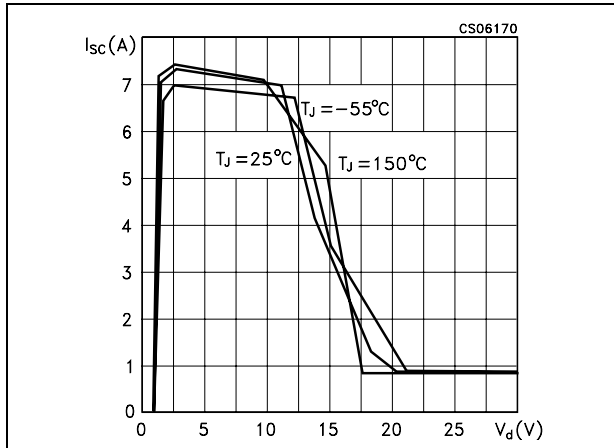

Figure 4. Line regulation vs temperature

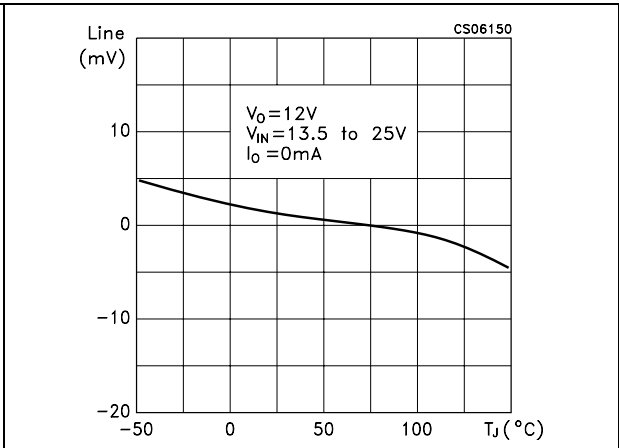

Figure 5. Quiescent current vs temperature

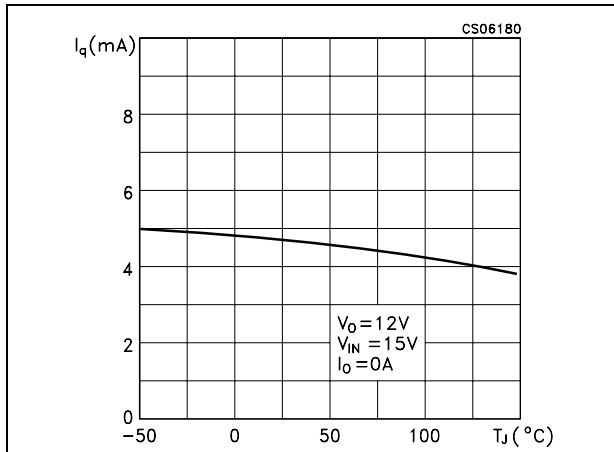

Figure 6. Output voltage vs temperature

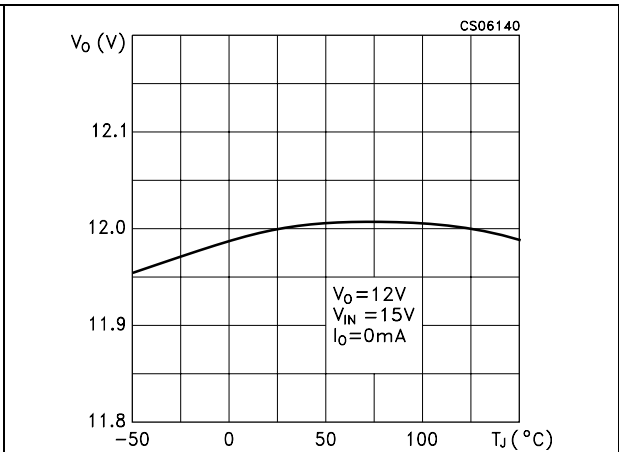

Figure 7. Load regulation vs temperature

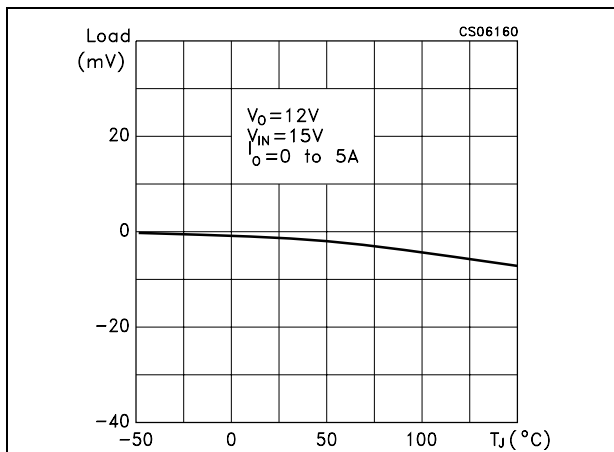

Figure 8. Quiescent current vs output voltage

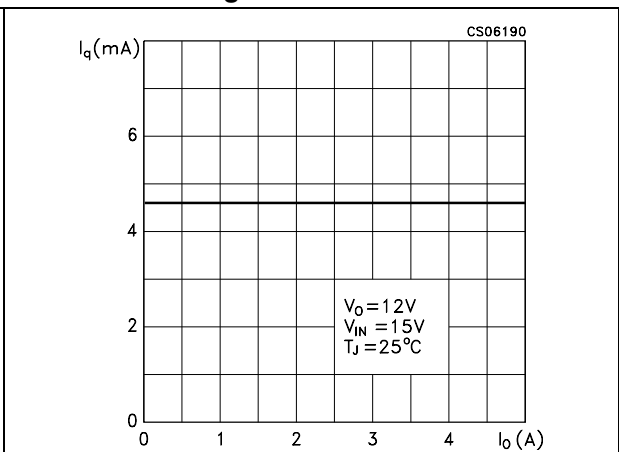

Figure 9. Quiescent current vs input voltage Figure 10. Dropout voltage vs output current

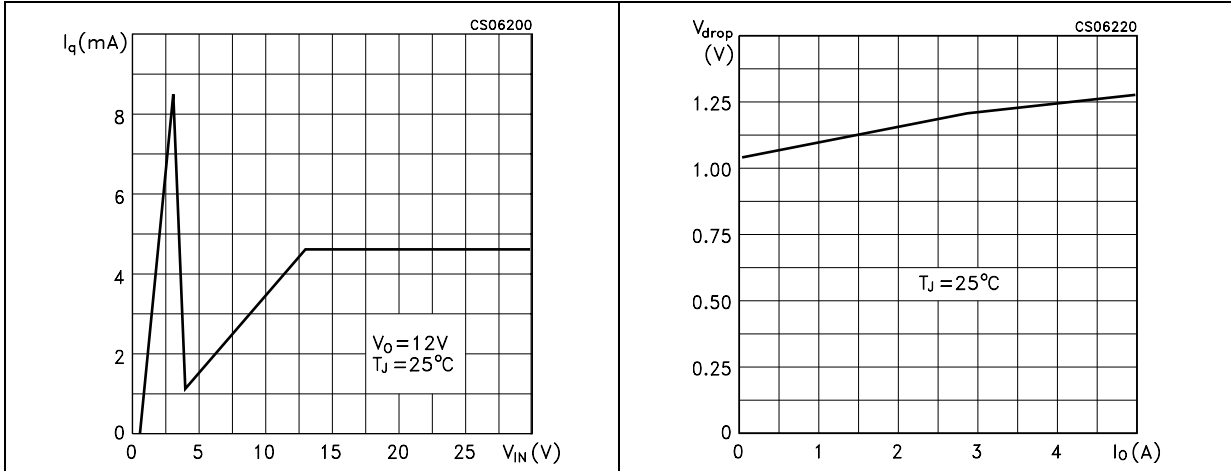

Figure 11. Supply voltage rejection vs output current Figure 12. Dropout voltage vs temperature

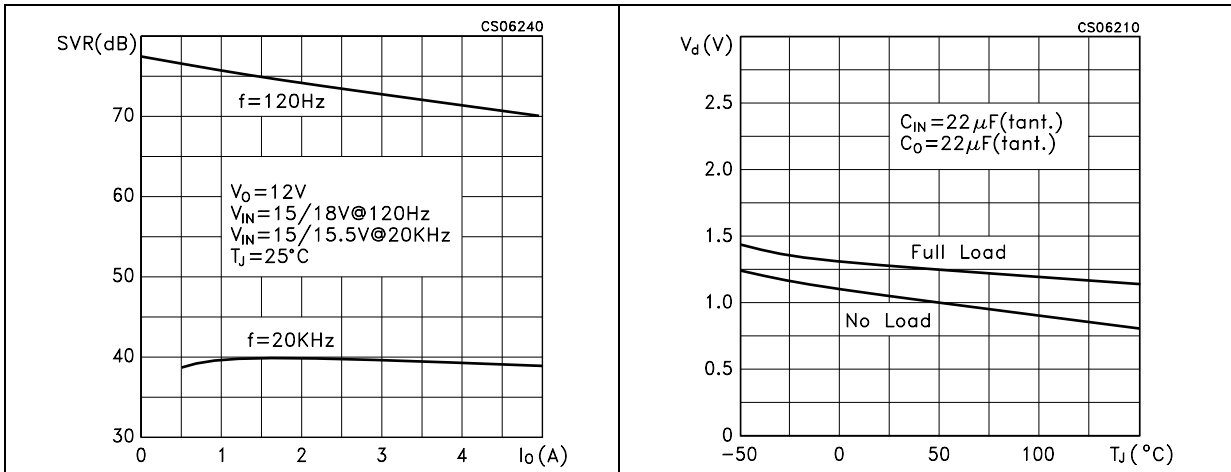

Figure 13. Supply voltage rejection vs temperature Figure 14. Supply voltage rejection vs frequency

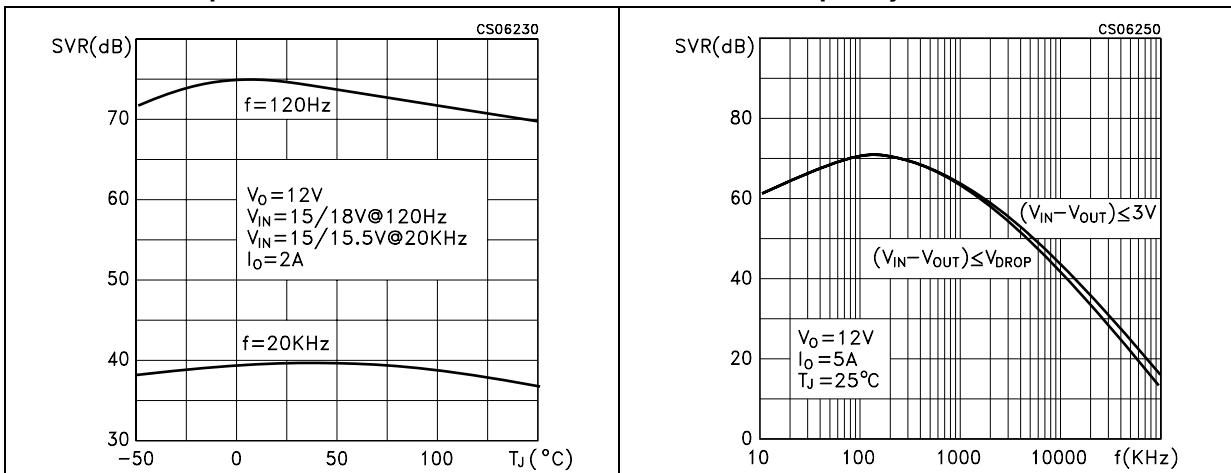

Figure 15. Adjust pin current vs output current

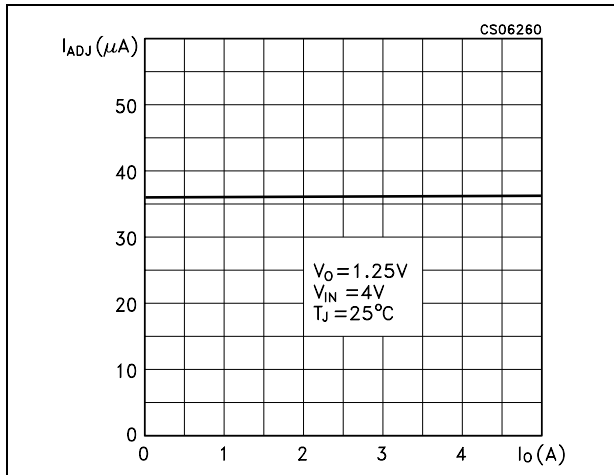

Figure 16. Reference voltage vs temperature

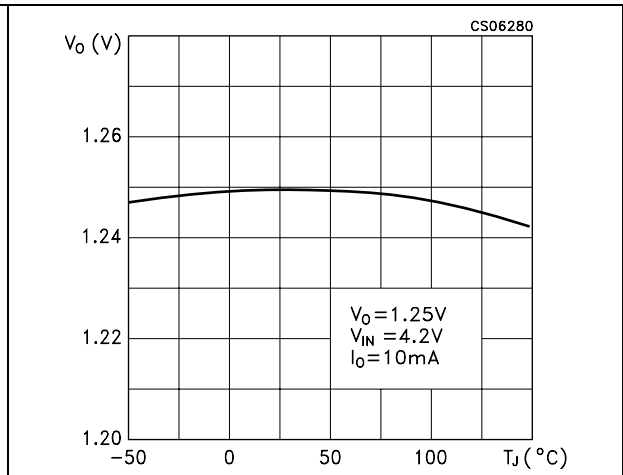

Figure 17. Load regulation vs temperature

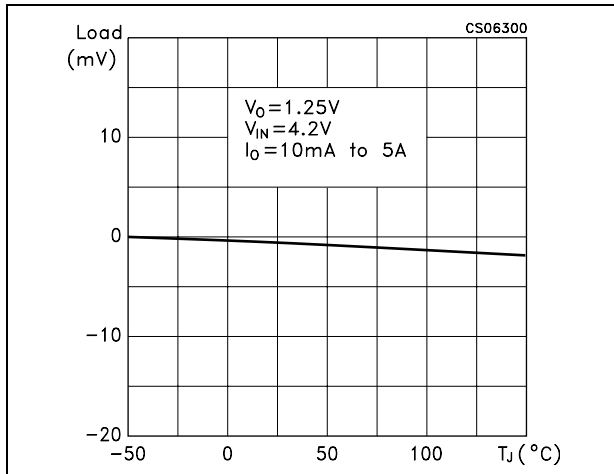

Figure 18. Adjust pin current vs temperature

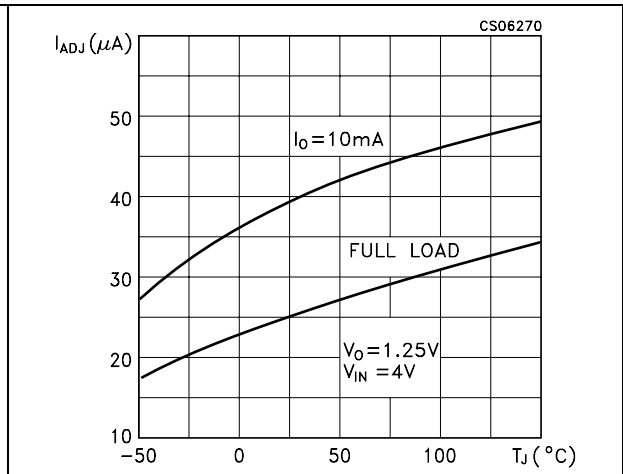

Figure 19. Line regulation vs temperature

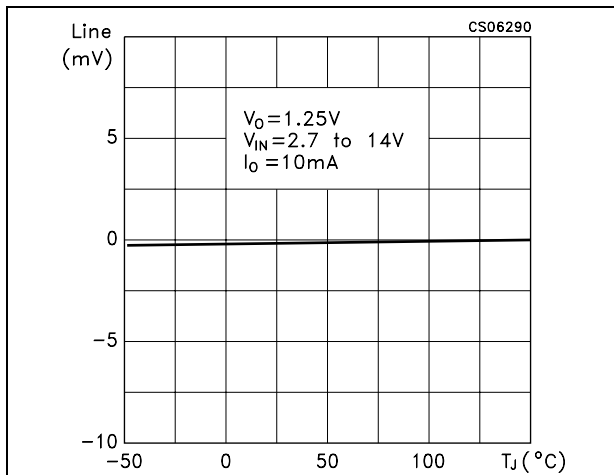

Figure 20. Minimum load current vs temperature

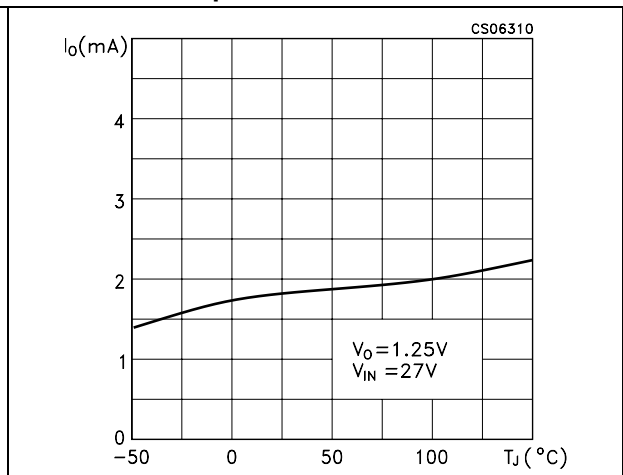

Figure 21. Supply voltage rejection vs temperature

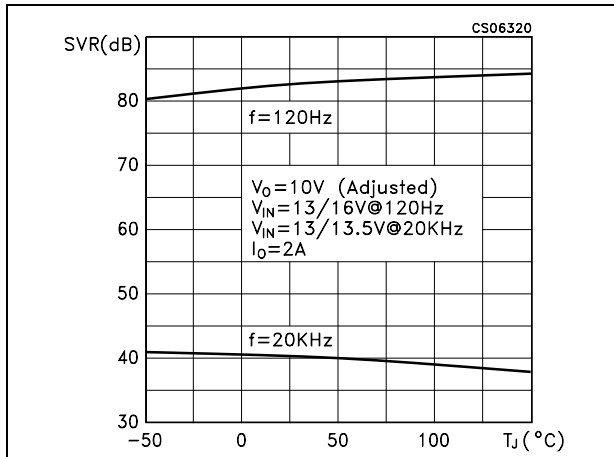

Figure 22. Supply voltage rejection vs frequency

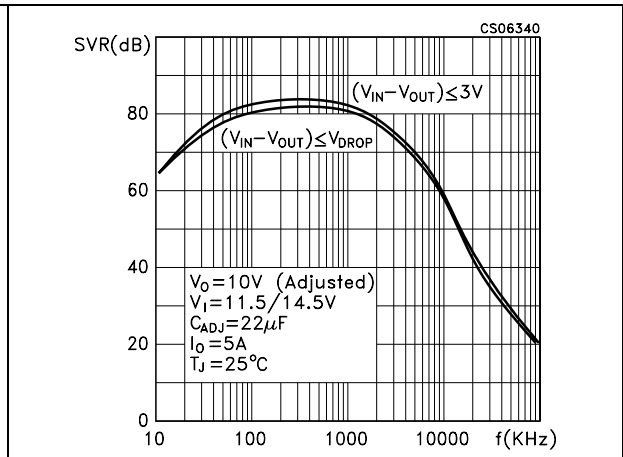

Figure 23. Stability

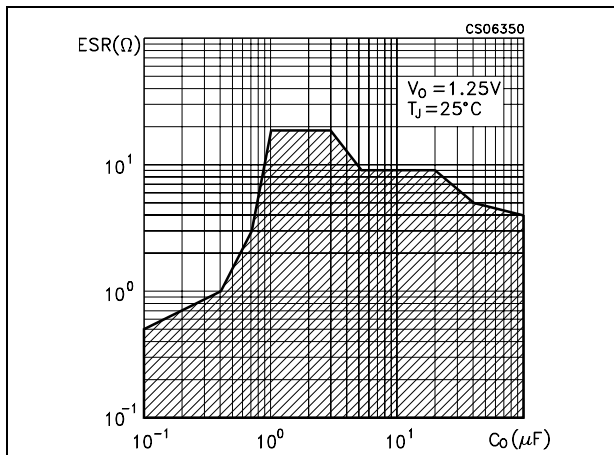

Figure 24. Supply voltage rejection vs output current

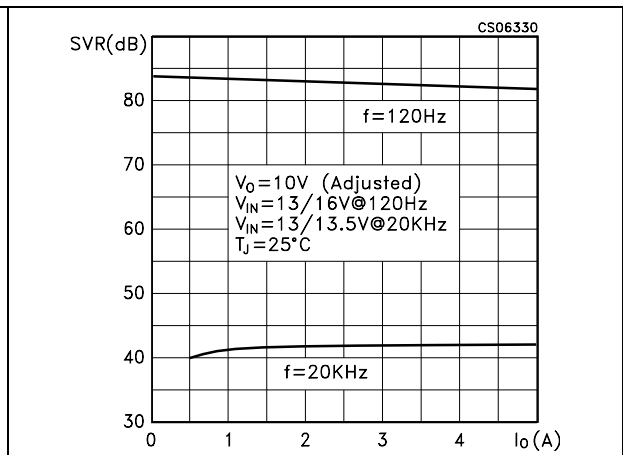

Figure 25. Stability

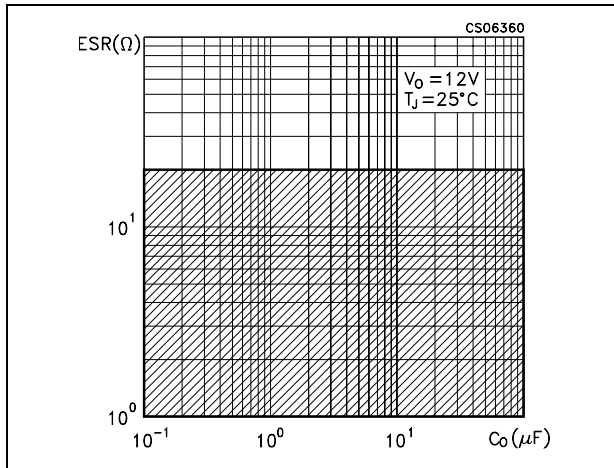

Figure 26. Line transient

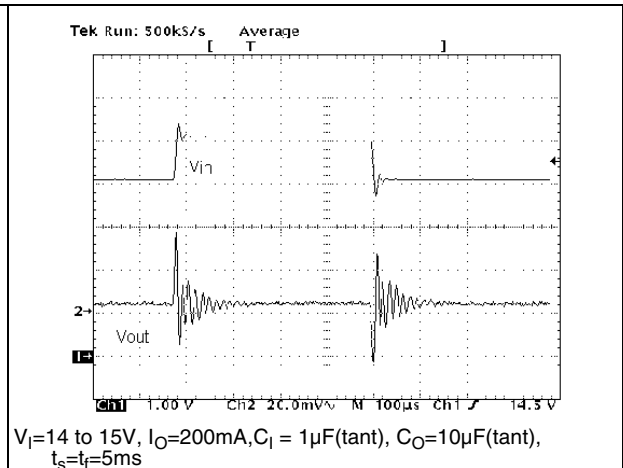

Figure 27. Line transient

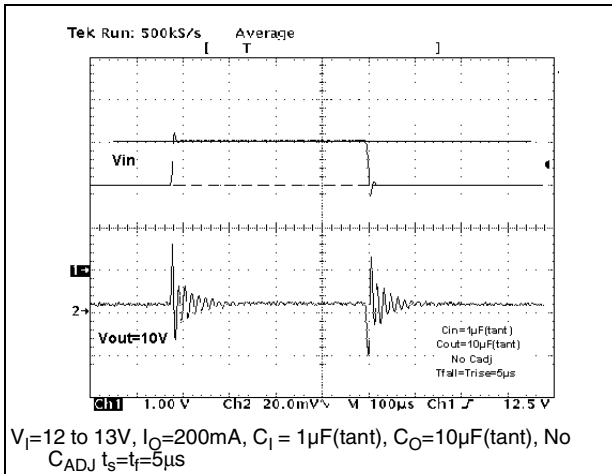

Figure 28. Load transient

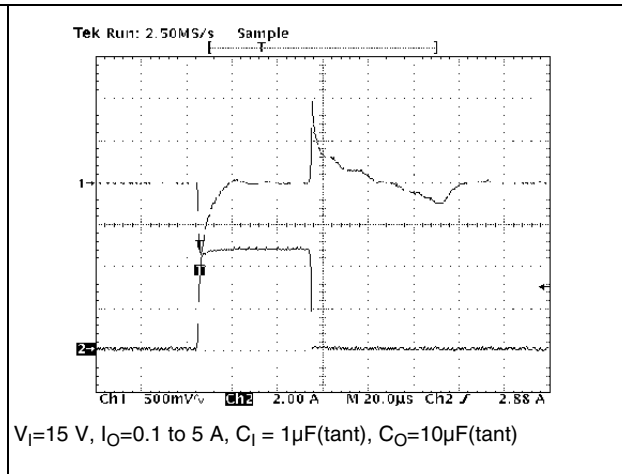

Figure 29. Load transient

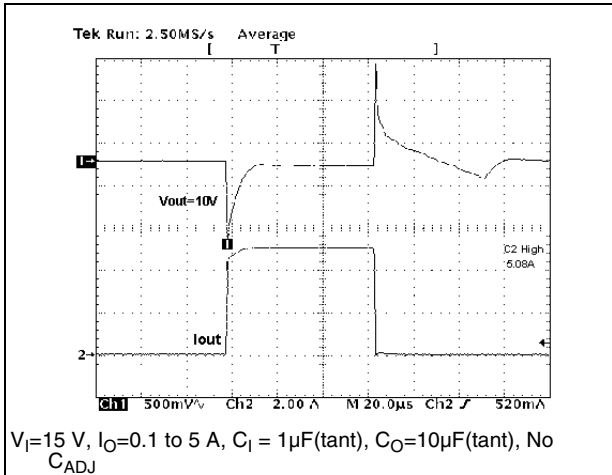

Figure 30. Line transient

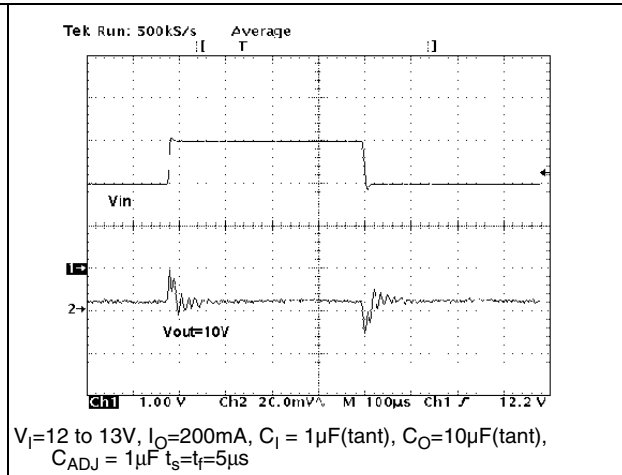
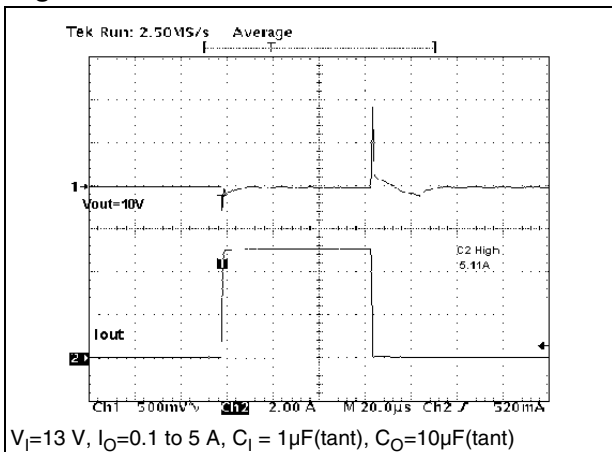

Figure 31. Load Transient



6 Package mechanical data

In order to meet environmental requirements, ST offers these devices in ECOPACK® packages. These packages have a Lead-free second level interconnect. The category of second Level Interconnect is marked on the package and on the inner box label, in compliance with JEDEC Standard JESD97. The maximum ratings related to soldering conditions are also marked on the inner box label. ECOPACK is an ST trademark. ECOPACK specifications are available at: www.st.com.

TO-220 MECHANICAL DATA

DIM.	mm.			inch		
	MIN.	TYP	MAX.	MIN.	TYP.	MAX.
A	4.40		4.60	0.173		0.181
C	1.23		1.32	0.048		0.051
D	2.40		2.72	0.094		0.107
D1		1.27			0.050	
E	0.49		0.70	0.019		0.027
F	0.61		0.88	0.024		0.034
F1	1.14		1.70	0.044		0.067
F2	1.14		1.70	0.044		0.067
G	4.95		5.15	0.194		0.203
G1	2.4		2.7	0.094		0.106
H2	10.0		10.40	0.393		0.409
L2		16.4			0.645	
L4	13.0		14.0	0.511		0.551
L5	2.65		2.95	0.104		0.116
L6	15.25		15.75	0.600		0.620
L7	6.2		6.6	0.244		0.260
L9	3.5		3.93	0.137		0.154
DIA.	3.75		3.85	0.147		0.151

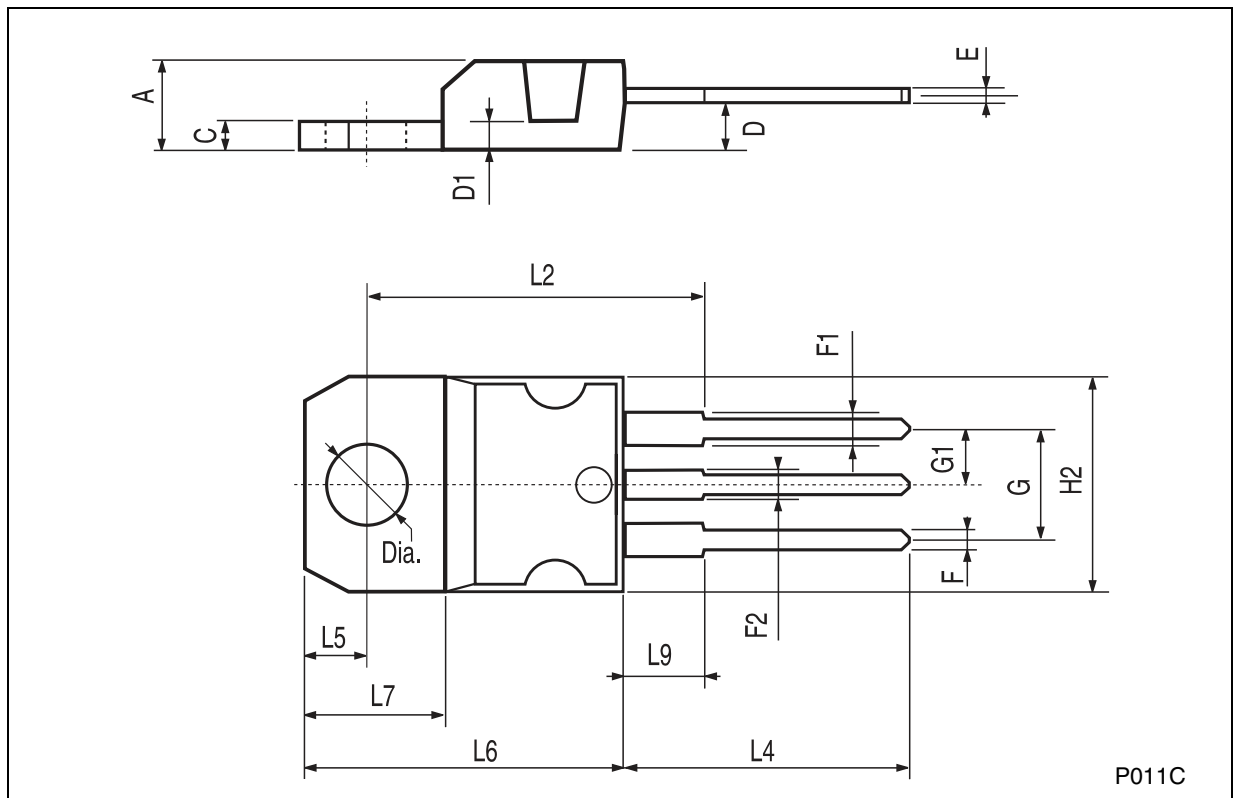

D²PAK MECHANICAL DATA

DIM.	mm.			inch		
	MIN.	TYP	MAX.	MIN.	TYP.	MAX.
A	4.4		4.6	0.173		0.181
A1	2.49		2.69	0.098		0.106
A2	0.03		0.23	0.001		0.009
B	0.7		0.93	0.027		0.036
B2	1.14		1.7	0.044		0.067
C	0.45		0.6	0.017		0.023
C2	1.23		1.36	0.048		0.053
D	8.95		9.35	0.352		0.368
D1		8			0.315	
E	10		10.4	0.393		0.409
E1		8.5			0.335	
G	4.88		5.28	0.192		0.208
L	15		15.85	0.590		0.624
L2	1.27		1.4	0.050		0.055
L3	1.4		1.75	0.055		0.068
M	2.4		3.2	0.094		0.126
R		0.4			0.016	
V2	0°		8°	0°		8°

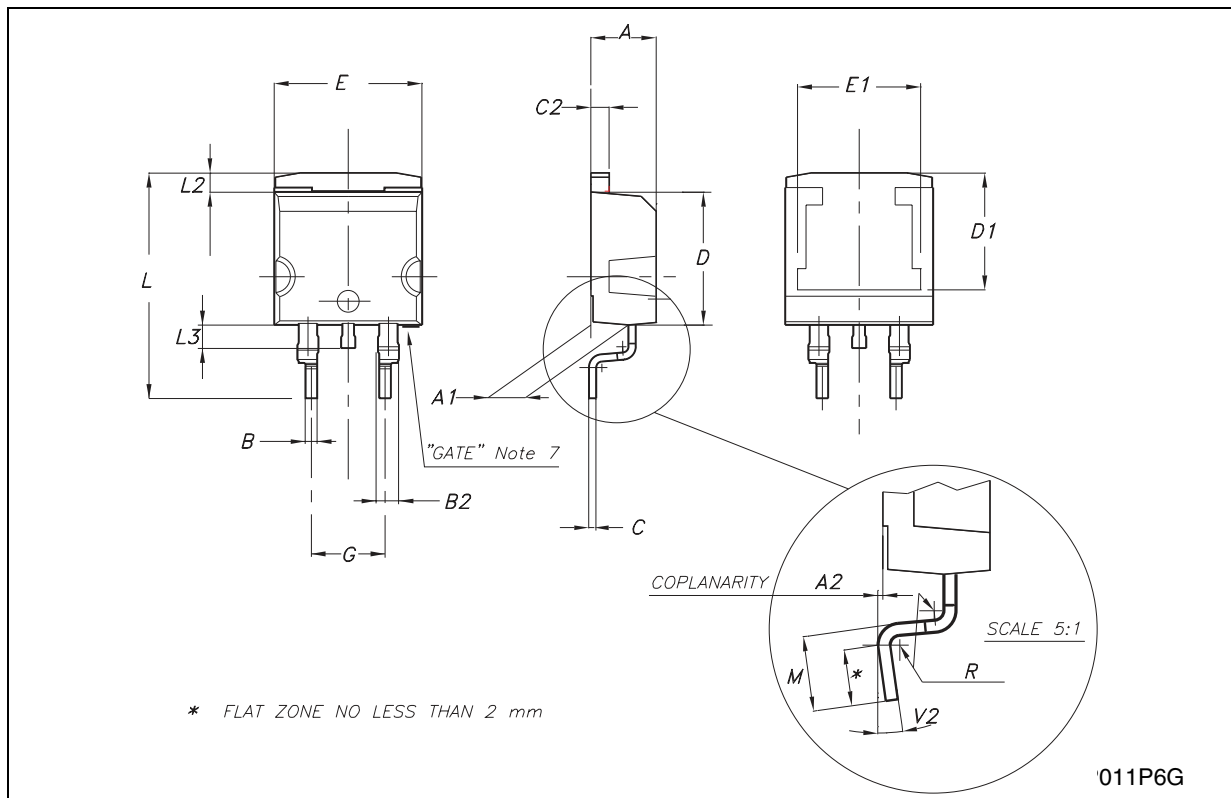

011P6G

D²PAK/A MECHANICAL DATA

DIM.	mm.			inch		
	MIN.	TYP	MAX.	MIN.	TYP.	MAX.
A	4.40		4.60	0.173		0.181
A1	2.49		2.69	0.098		0.106
A2	0.03		0.23	0.001		0.009
B	0.7		0.93	0.028		0.037
B1	0.8		1.3	0.031		0.051
B2	1.14		1.7	0.045		0.067
C	0.45		0.60	0.018		0.024
C2	1.23		1.36	0.048		0.054
D	8.95		9.35	0.352		0.368
D1		8			0.315	
E	10		10.4	0.394		0.409
E1		8.5			0.335	
G	4.88		5.28	0.192		0.208
L	15		15.85	0.591		0.624
L2	1.27		1.4	0.050		0.055
M	2.4		3.2	0.094		0.126
R		0.4			0.016	
V2	0°		8°	0°		8°

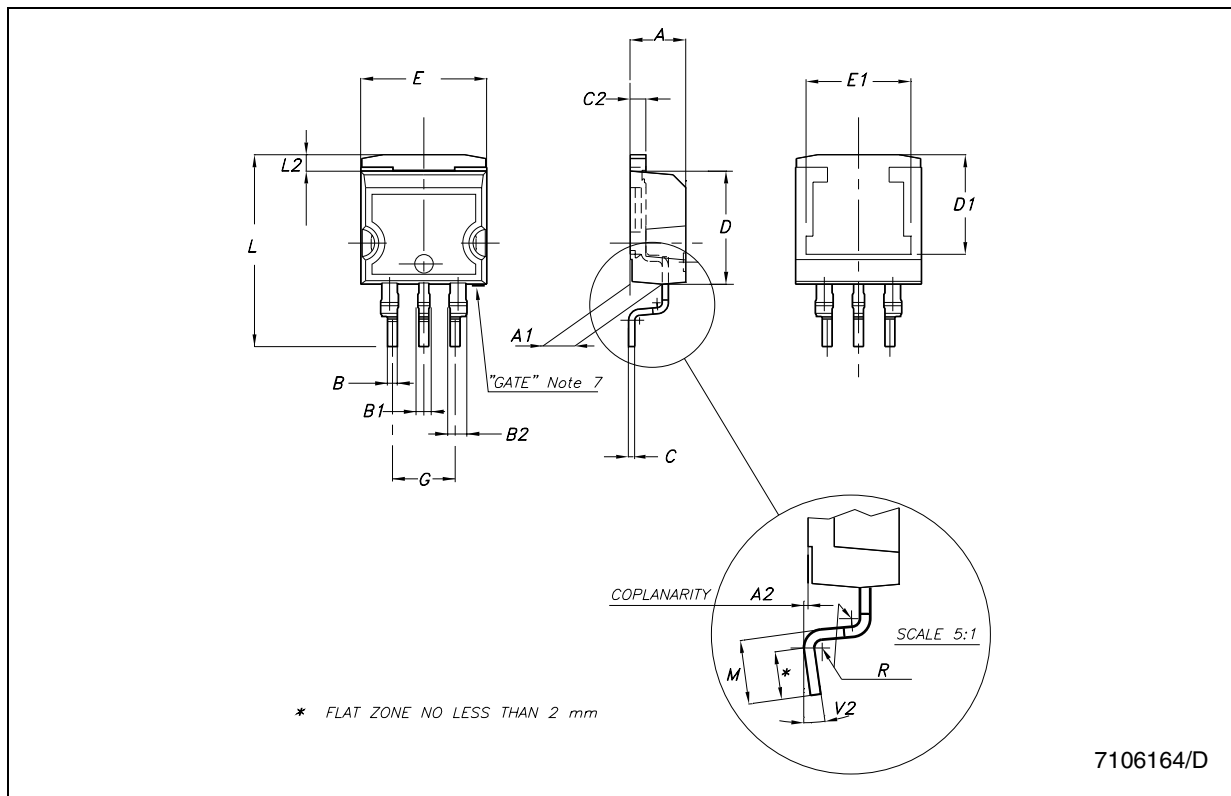

7106164/D

Tape & Reel D²PAK-P²PAK-D²PAK/A-P²PAK/A MECHANICAL DATA

DIM.	mm.			inch		
	MIN.	TYP	MAX.	MIN.	TYP.	MAX.
A			180			7.086
C	12.8	13.0	13.2	0.504	0.512	0.519
D	20.2			0.795		
N	60			2.362		
T			14.4			0.567
Ao	10.50	10.6	10.70	0.413	0.417	0.421
Bo	15.70	15.80	15.90	0.618	0.622	0.626
Ko	4.80	4.90	5.00	0.189	0.193	0.197
Po	3.9	4.0	4.1	0.153	0.157	0.161
P	11.9	12.0	12.1	0.468	0.472	0.476

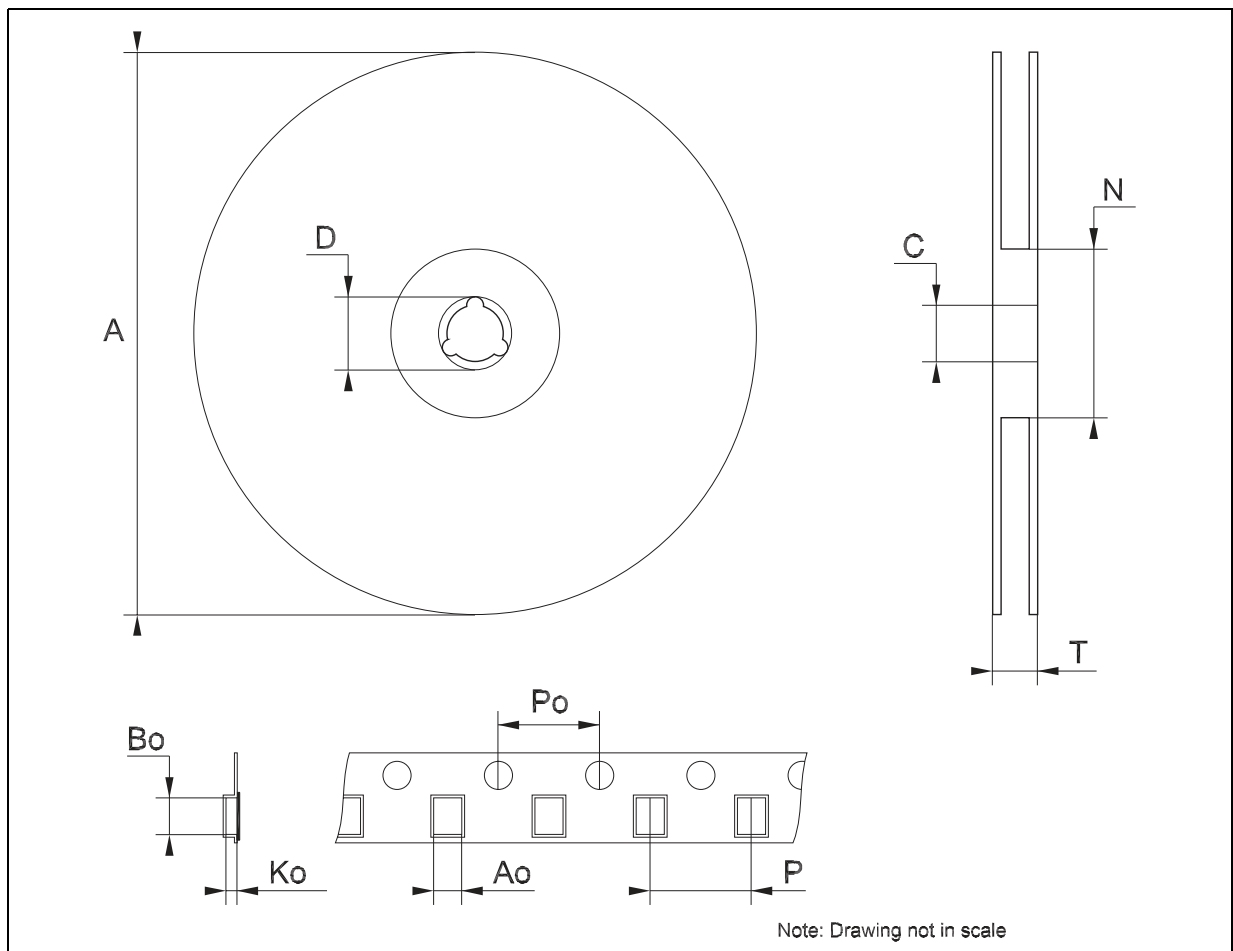

7 Order codes

Table 14. Order codes

Part numbers			
Packages			Output voltage
TO-220	D ² PAK	D ² PAK/A	
LD1084V15 ⁽¹⁾		LD1084D2M15R ⁽¹⁾	1.5 V
LD1084V18	LD1084D2T18R	LD1084D2M18R	1.8 V
LD1084V25	LD1084D2T25R	LD1084D2M25R	2.5 V
LD1084V28 ⁽¹⁾		LD1084D2M28R ⁽¹⁾	2.85 V
LD1084V33	LD1084D2T33R	LD1084D2M33R	3.3 V
LD1084V36	LD1084D2T36R	LD1084D2M36R	3.6 V
LD1084V50	LD1084D2T50R	LD1084D2M50R	5.0 V
LD1084V80	LD1084D2T80R	LD1084D2M80R	8.0 V
LD1084V90	LD1084D2T90R	LD1084D2M90R	9.0 V
LD1084V12	LD1084D2T12R	LD1084D2M12R	12.0 V
LD1084V	LD1084D2T-R	LD1084D2M-R	ADJ

1. Available on request.

8 Revision history

Table 15. Revision history

Date	Revision	Changes
07-Oct-2004	3	Mistake Order Codes - Table 1.
08-Feb-2005	4	Mistake U.M. Load Regulation - V ==> mV.
16-Jun-2005	5	Order Codes has been updated.
04-Apr-2007	6	Order Codes has been updated and the document has been reformatted.

Please Read Carefully:

Information in this document is provided solely in connection with ST products. STMicroelectronics NV and its subsidiaries ("ST") reserve the right to make changes, corrections, modifications or improvements, to this document, and the products and services described herein at any time, without notice.

All ST products are sold pursuant to ST's terms and conditions of sale.

Purchasers are solely responsible for the choice, selection and use of the ST products and services described herein, and ST assumes no liability whatsoever relating to the choice, selection or use of the ST products and services described herein.

No license, express or implied, by estoppel or otherwise, to any intellectual property rights is granted under this document. If any part of this document refers to any third party products or services it shall not be deemed a license grant by ST for the use of such third party products or services, or any intellectual property contained therein or considered as a warranty covering the use in any manner whatsoever of such third party products or services or any intellectual property contained therein.

UNLESS OTHERWISE SET FORTH IN ST'S TERMS AND CONDITIONS OF SALE ST DISCLAIMS ANY EXPRESS OR IMPLIED WARRANTY WITH RESPECT TO THE USE AND/OR SALE OF ST PRODUCTS INCLUDING WITHOUT LIMITATION IMPLIED WARRANTIES OF MERCHANTABILITY, FITNESS FOR A PARTICULAR PURPOSE (AND THEIR EQUIVALENTS UNDER THE LAWS OF ANY JURISDICTION), OR INFRINGEMENT OF ANY PATENT, COPYRIGHT OR OTHER INTELLECTUAL PROPERTY RIGHT.

UNLESS EXPRESSLY APPROVED IN WRITING BY AN AUTHORIZED ST REPRESENTATIVE, ST PRODUCTS ARE NOT RECOMMENDED, AUTHORIZED OR WARRANTED FOR USE IN MILITARY, AIR CRAFT, SPACE, LIFE SAVING, OR LIFE SUSTAINING APPLICATIONS, NOR IN PRODUCTS OR SYSTEMS WHERE FAILURE OR MALFUNCTION MAY RESULT IN PERSONAL INJURY, DEATH, OR SEVERE PROPERTY OR ENVIRONMENTAL DAMAGE. ST PRODUCTS WHICH ARE NOT SPECIFIED AS "AUTOMOTIVE GRADE" MAY ONLY BE USED IN AUTOMOTIVE APPLICATIONS AT USER'S OWN RISK.

Resale of ST products with provisions different from the statements and/or technical features set forth in this document shall immediately void any warranty granted by ST for the ST product or service described herein and shall not create or extend in any manner whatsoever, any liability of ST.

ST and the ST logo are trademarks or registered trademarks of ST in various countries.

Information in this document supersedes and replaces all information previously supplied.

The ST logo is a registered trademark of STMicroelectronics. All other names are the property of their respective owners.

© 2007 STMicroelectronics - All rights reserved

STMicroelectronics group of companies

Australia - Belgium - Brazil - Canada - China - Czech Republic - Finland - France - Germany - Hong Kong - India - Israel - Italy - Japan - Malaysia - Malta - Morocco - Singapore - Spain - Sweden - Switzerland - United Kingdom - United States of America

www.st.com