

QT-Brightek Chip LED Series**SMD 0606 RGB LED****Part No.: QBLP600-RGB-2943**



Table of Contents:

Introduction3
Electrical / Optical Characteristic (Ta=25 °C)4
Absolute Maximum Rating4
Characteristic Curves.....6
Solder Profile & Footprint.....7
Packing8
Ordering Information9
Revision History 10
Disclaimer 10

Introduction

Feature:

- White Diffused lens
- Package in tape and reel
- Ultra bright 0606 LED package
- Common Anode
- AlInGaP technology for R
- InGaN technology for IB/IG
- Viewing angle: 140 deg typ.

Description:

These ultra bright 0606 RGB LEDs have a height profile of 0.80mm. Combination of high brightness output and small footprint, these LEDs are ideal for keypad backlighting, status indication, and color mixing applications.

Application:

- Status indication
- Back lighting application

Certification & Compliance:

- TS16949
- ISO9001
- RoHS Compliant



Dimension:

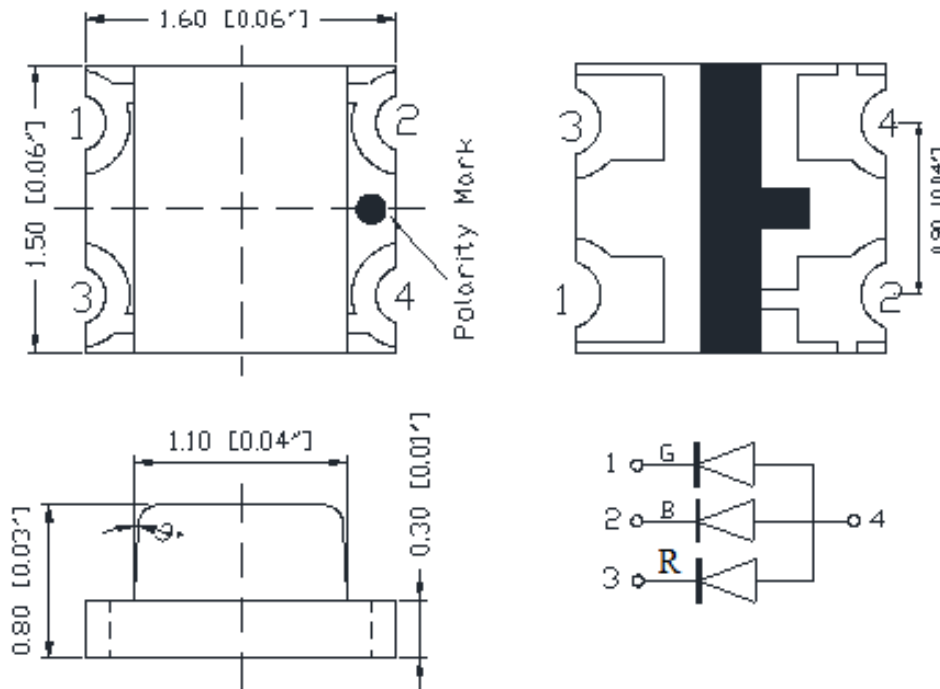

Units: mm / tolerance = +/-0.1mm

Electrical / Optical Characteristic (Ta=25 °C)

Product	Color	I _F (mA)	V _F (V)		λ _D (nm)			I _V (mcd)	
			Typ.	Max	Min	Typ.	Max	Min	Typ.
QBLP600-RGB-2943	Red	20	2.0	2.5	615	620	630	100	200
	True Green	20	3.4	3.7	515	520	525	320	630
	Blue	20	3.1	3.7	460	465	470	50	110

Absolute Maximum Rating

Material	P _d (mW)	I _F (mA)	I _{FP} (mA)*	V _R (V)	T _{OP} (°C)	T _{ST} (°C)	T _{SOL} (°C)**
AllnGaP (R)	75	30	125	5	-40 ~ + 80	-40 ~ +85	260
InGaN (IB/IG)	111	30	125	5	-40 ~ + 80	-40 ~ +85	260

*Duty 1/8 @ 1KHz

**IR Reflow for no more than 10 sec @ 260 °C

Luminous Intensity I_V for Red @ $I_F=20mA$

Bin	Min.	Max.	Unit
A	100	160	mcd
B	160	250	

Luminous Intensity I_V for Green @ $I_F=20mA$

Bin	Min.	Max.	Unit
R	320	500	mcd
S	500	800	

Luminous Intensity I_V for Blue @ $I_F=20mA$

Bin	Min.	Max.	Unit
J	50	80	mcd
K	80	125	

Dominant Wavelength λ_D for Red @ $I_F=20mA$

Bin	Min.	Max.	Unit
s	615	620	nm
t	620	625	
u	625	630	

Dominant Wavelength λ_D for Green @ $I_F=20mA$

Bin	Min.	Max.	Unit
S	515	517.5	nm
T	517.5	520	
U	520	522.5	
V	522.5	525	

Dominant Wavelength λ_D for Blue @ $I_F=20mA$

Bin	Min.	Max.	Unit
E	460	462.5	nm
F	462.5	465	
G	465	467.5	
H	467.5	470	

Characteristic Curves

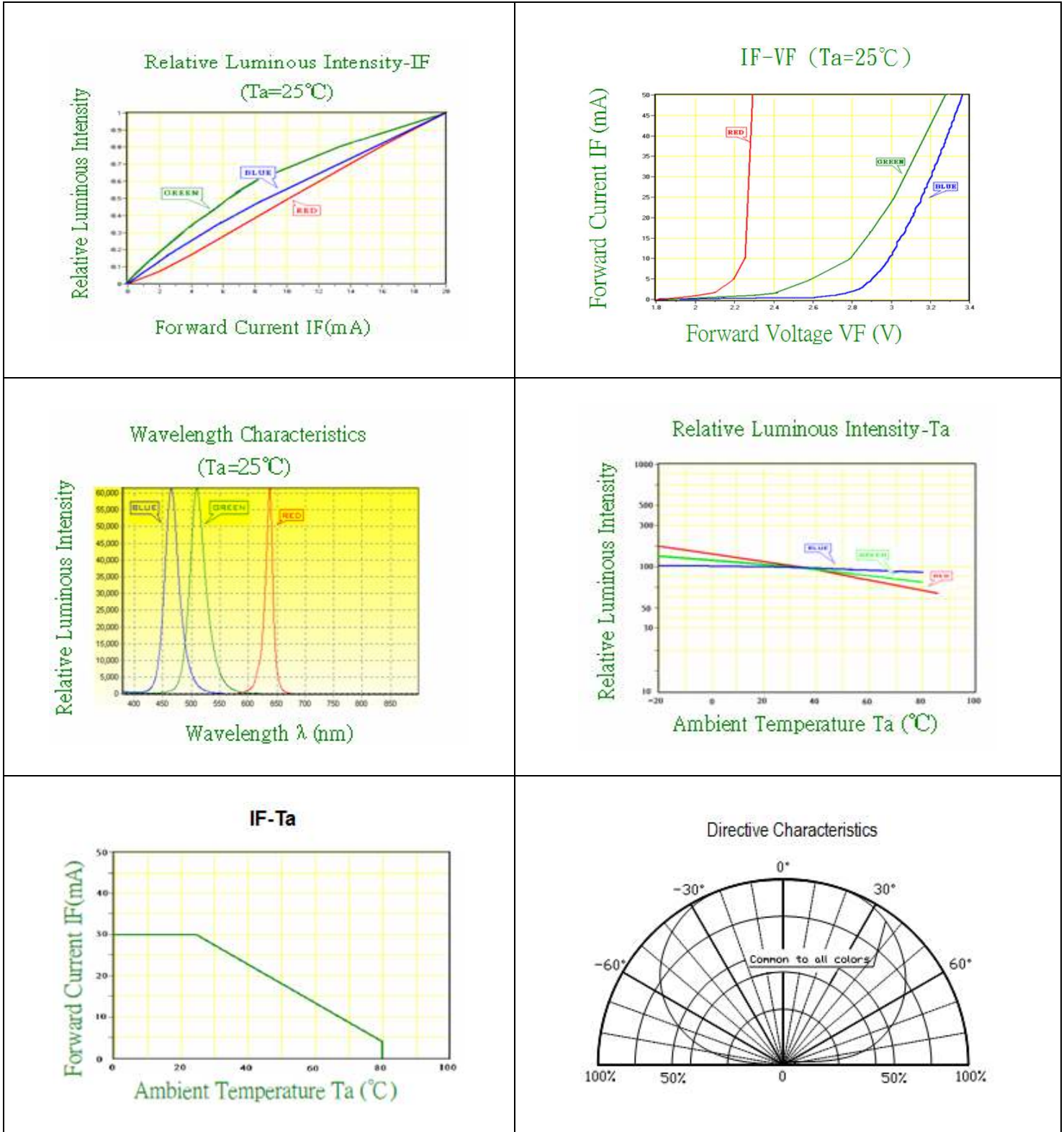

Solder Profile & Footprint

-The recommended reflow soldering profile is as follows (temperatures indicated are as measured on the surface of the LED resin):

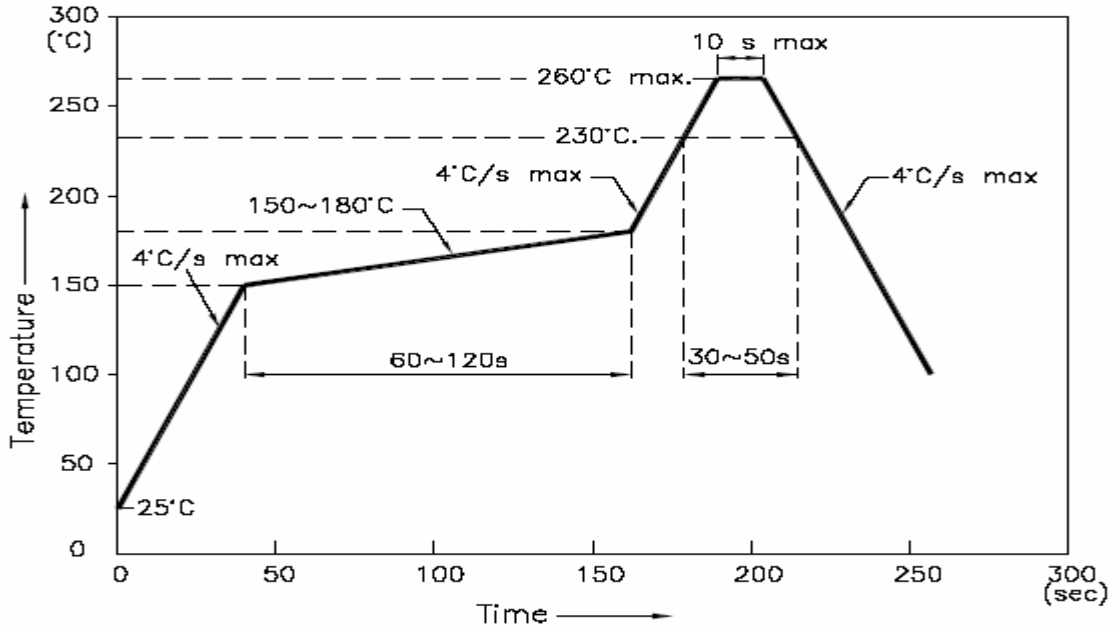

Recommended Pad Layout

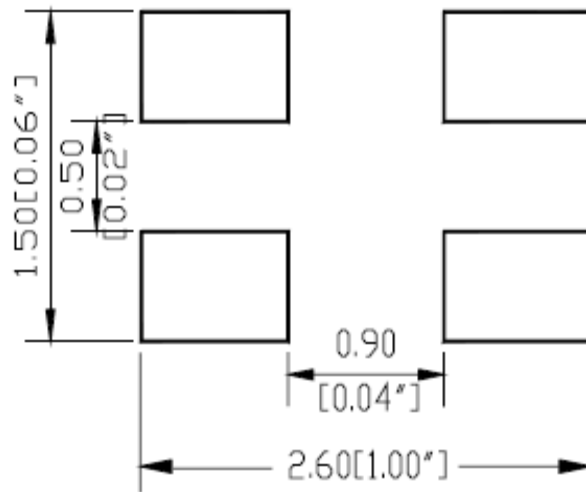

Units: mm

Tolerance: ± 0.1mm

Packing

Reel Dimension:

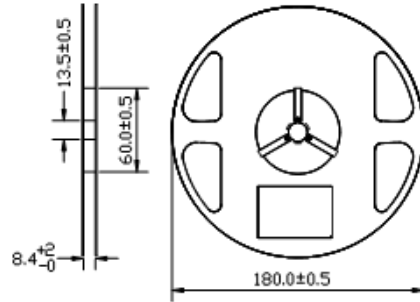

Unit: mm

Tape Dimension:

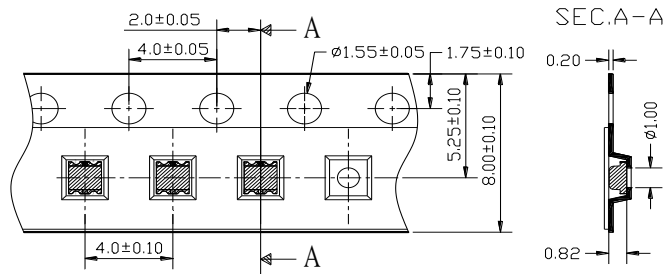

Unit: mm

Arrangement of Tape:

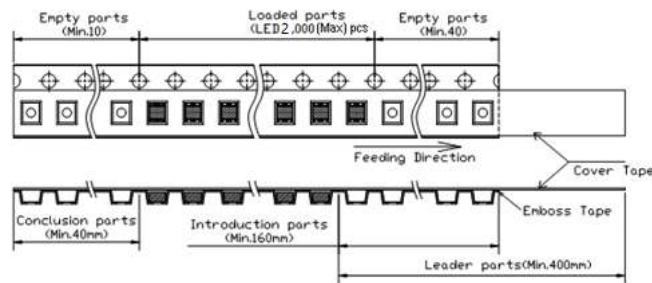

Packaging Specification:

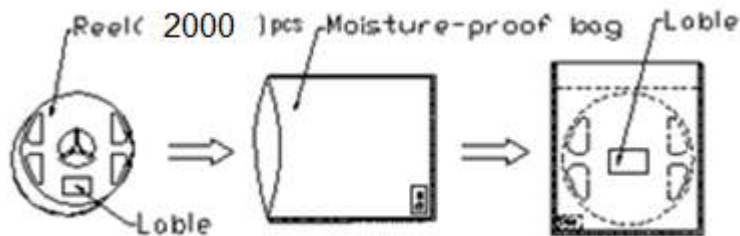



Ordering Information

Part #	Orderable Part #	Spec Range	Quantity per reel
QBLP600-RGB-2943	QBLP600-RGB-2943	Red: $I_v=200\text{mcd typ. @ } I_F=20\text{mA}$, $\lambda_D=615\text{nm to } 630\text{nm}$	2,000
		True Green: $I_v=630\text{mcd typ. @ } I_F=20\text{mA}$, $\lambda_D=515\text{nm to } 525\text{nm}$	
		Blue: $I_v=110\text{mcd typ. @ } I_F=20\text{mA}$, $\lambda_D=460\text{nm to } 470\text{nm}$	

Revision History

Description:	Revision #	Revision Date
New Release of QBLP600-RGB-2943	V1.0	11/08/2018



Disclaimer

QT-BRIGHTEK reserves the right to make changes without further notice to any products herein to improve reliability, function or design. QT-BRIGHTEK does not assume any liability arising out of the application or use of any product or circuit described herein; neither does it convey any license under its patent rights, nor the rights of others.

Life Support Policy

QT-BRIGHTEK's products are not authorized for use as critical components in life support devices or systems without the express written approval of QT-BRIGHTEK. As used herein:

1. Life support devices or systems are devices or systems which, (a) are intended for surgical implant into the body, or (b) support or sustain life, and (c) whose failure to perform when properly used in accordance with instructions for use provided in the labeling, can be reasonably expected to result in a significant injury of the user.
2. A critical component in any component of a life support device or system whose failure to perform can be reasonably expected to cause the failure of the life support device or system, or to affect its safety or effectiveness.