

## TINA-Y-W

~36° wide beam. Assembly with holder, installation tape and pins

### SPECIFICATION:

Dimensions	Ø 16.1 mm
Height	10 mm
Fastening	tape, pin
ROHS compliant	yes ⓘ

### MATERIALS:

Component	Type	Material	Colour	Finish
TINA-Y-W	Single lens	PMMA	clear	gloss
TINA-Y-HLD	Holder	PC	black	gloss
TINA-Y-TAPE	Tape	Acrylic foam		

### ORDERING INFORMATION:



Component	Qty in box	MOQ	MPQ	Box weight (kg)
CA18105_TINA-Y-W » Box size: 476 x 273 x 197 mm	3900	300	300	6.0

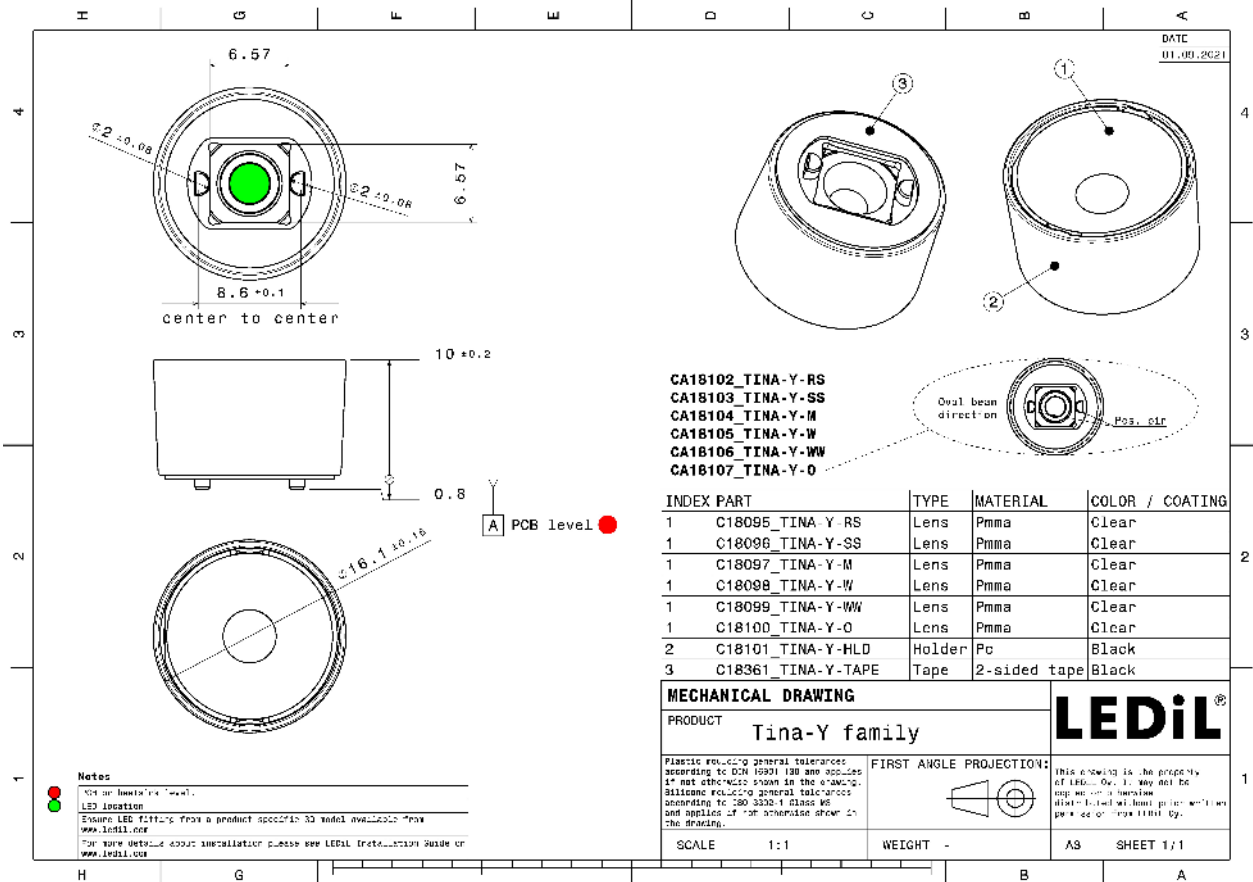



See also our general installation guide: [www.ledil.com/installation\\_guide](http://www.ledil.com/installation_guide)



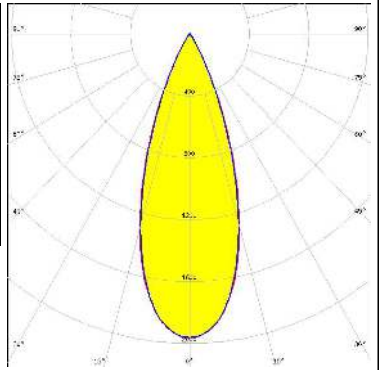
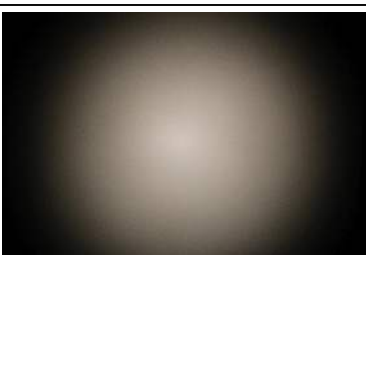
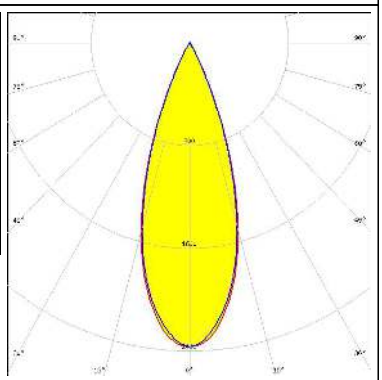

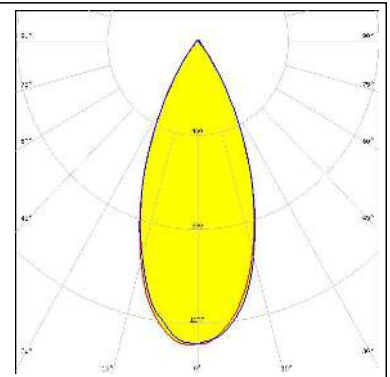
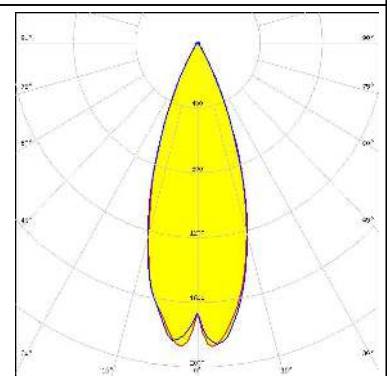
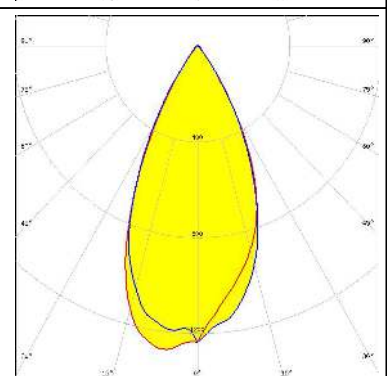
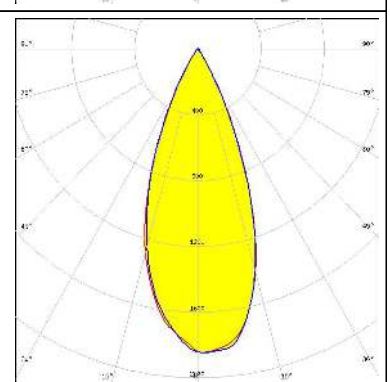

### OPTICAL RESULTS (MEASURED):

<p><b>CREE</b>  LED</p> <p>LED XP-G3 FWHM / FWTM 37.0° / 58.0° Efficiency 79 % Peak intensity 2 cd/lm LEDs/each optic 1 Light colour White Required components:</p>		
<p><b>NICHIA</b></p> <p>LED NVSW719AC FWHM / FWTM 36.0° / 55.0° Efficiency 86 % Peak intensity 2.4 cd/lm LEDs/each optic 1 Light colour White Required components:</p>		

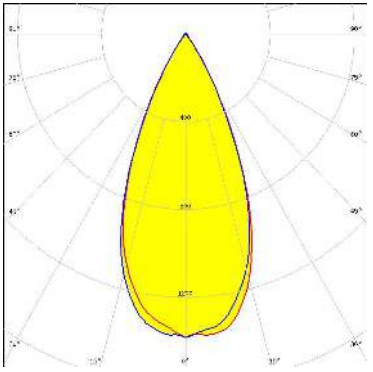
#### OPTICAL RESULTS (SIMULATED):

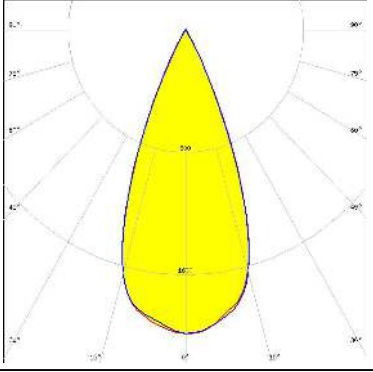
<p><b>CREE</b> → <b>LED</b></p> <p>LED: XHP35.2 HD            FWHM / FWTM: 44.0° / 70.0°            Efficiency: 75 %            Peak intensity: 1.3 cd/lm            LEDs/each optic: 1            Light colour: White            Required components:</p>	
<p><b>CREE</b> → <b>LED</b></p> <p>LED: XHP35.2 HI            FWHM / FWTM: 37.0° / 58.0°            Efficiency: 77 %            Peak intensity: 1.9 cd/lm            LEDs/each optic: 1            Light colour: White            Required components:</p>	
<p><b>CREE</b> → <b>LED</b></p> <p>LED: XM-L RGBW (XMLDCL HD)            FWHM / FWTM: 48.0° / 72.0°            Efficiency: 84 %            Peak intensity: 1.3 cd/lm            LEDs/each optic: 1            Light colour: RGBW            Required components:</p>	
<p><b>CREE</b> → <b>LED</b></p> <p>LED: XM-L RGBW (XMLDCL HI)            FWHM / FWTM: 41.0° / 62.0°            Efficiency: 86 %            Peak intensity: 1.9 cd/lm            LEDs/each optic: 1            Light colour: RGBW            Required components:</p>	

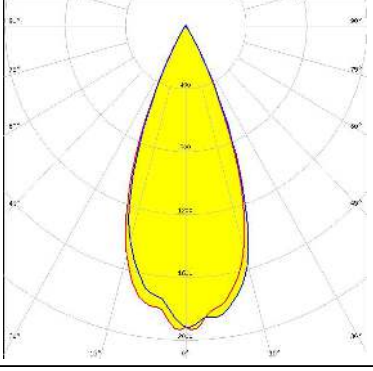
#### OPTICAL RESULTS (SIMULATED):

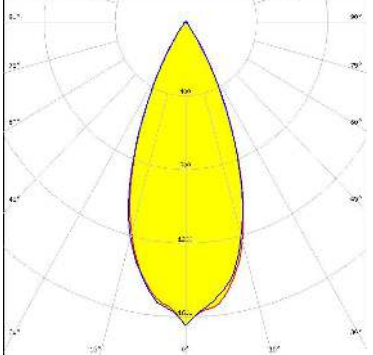
	<p>LED XM-L3            FWHM / FWTM 45.0° / 67.0°            Efficiency 80 %            Peak intensity 1.4 cd/lm            LEDs/each optic 1            Light colour White            Required components:</p>	
	<p>LED XP-E2            FWHM / FWTM 42.0° / 57.0°            Efficiency 88 %            Peak intensity 2 cd/lm            LEDs/each optic 1            Light colour White            Required components:</p>	
	<p>LED XP-G2            FWHM / FWTM 42.0° / 59.0°            Efficiency 87 %            Peak intensity 1.9 cd/lm            LEDs/each optic 1            Light colour White            Required components:</p>	
	<p>LED XP-L HD            FWHM / FWTM 42.0° / 66.0°            Efficiency 84 %            Peak intensity 1.6 cd/lm            LEDs/each optic 1            Light colour White            Required components:</p>	

#### OPTICAL RESULTS (SIMULATED):

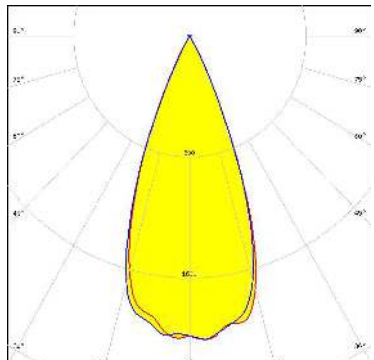
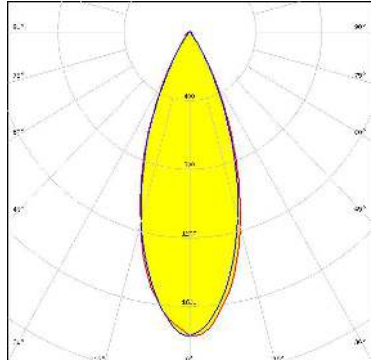
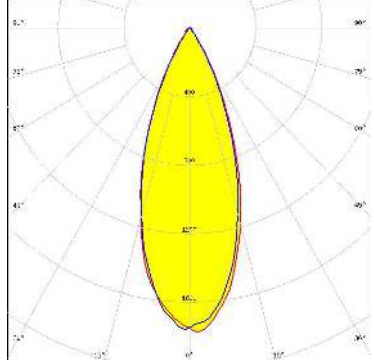
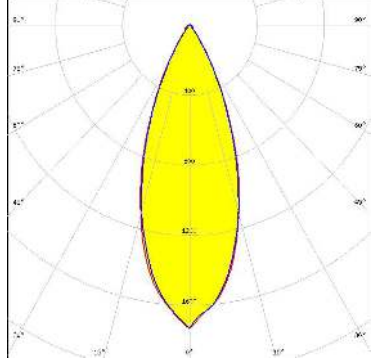
<p><b>CREE</b> </p> <p>LED: XQ-E HI            FWHM / FWTM: 42.0° / 56.0°            Efficiency: 87 %            Peak intensity: 2 cd/lm            LEDs/each optic: 1            Light colour: White            Required components:</p>	
<p><b>LUMILEDS</b></p> <p>LED: LUXEON 5050 Round LES            FWHM / FWTM: 38.0° / 64.0°            Efficiency: 82 %            Peak intensity: 1.8 cd/lm            LEDs/each optic: 1            Light colour: White            Required components:</p>	
<p><b>LUMILEDS</b></p> <p>LED: LUXEON 5050 Round LES            FWHM / FWTM: 38.0° / 65.0°            Efficiency: 82 %            Peak intensity: 1.8 cd/lm            LEDs/each optic: 1            Light colour: White            Required components:</p>	
<p><b>LUMILEDS</b></p> <p>LED: LUXEON 5050 Square LES            FWHM / FWTM: 38.0° / 64.0°            Efficiency: 81 %            Peak intensity: 1.7 cd/lm            LEDs/each optic: 1            Light colour: White            Required components:</p>	

### OPTICAL RESULTS (SIMULATED):

#### LUMILEDS

LED LUXEON C  
 FWHM / FWTM 42.0° / 58.0°  
 Efficiency 80 %  
 Peak intensity 1.8 cd/lm  
 LEDs/each optic 1  
 Light colour White  
 Required components:

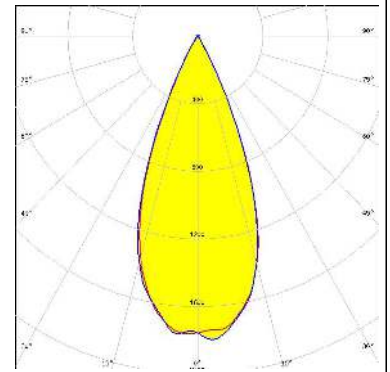

#### LUMILEDS

LED LUXEON HL2X  
 FWHM / FWTM 48.0° / 66.0°  
 Efficiency 86 %  
 Peak intensity 1.5 cd/lm  
 LEDs/each optic 1  
 Light colour White  
 Required components:

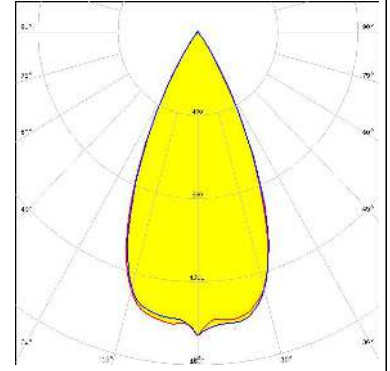

#### LUMILEDS

LED LUXEON MZ  
 FWHM / FWTM 37.0° / 60.0°  
 Efficiency 83 %  
 Peak intensity 2 cd/lm  
 LEDs/each optic 1  
 Light colour White  
 Required components:

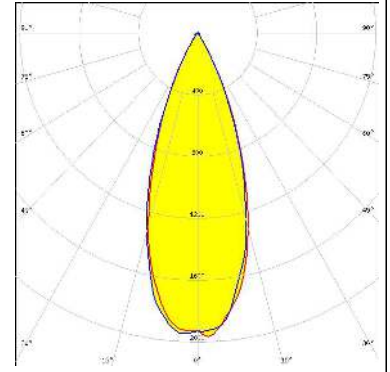

#### LUMILEDS

LED LUXEON TX  
 FWHM / FWTM 40.0° / 59.0°  
 Efficiency 85 %  
 Peak intensity 1.9 cd/lm  
 LEDs/each optic 1  
 Light colour White  
 Required components:

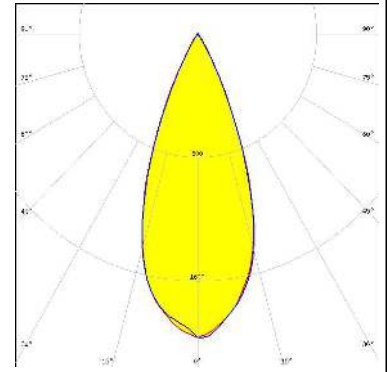

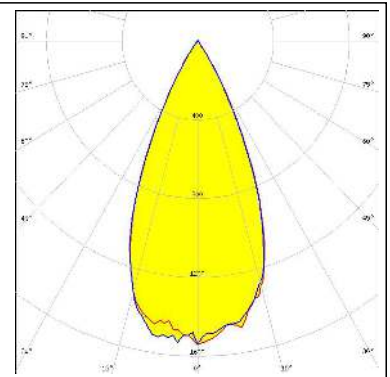
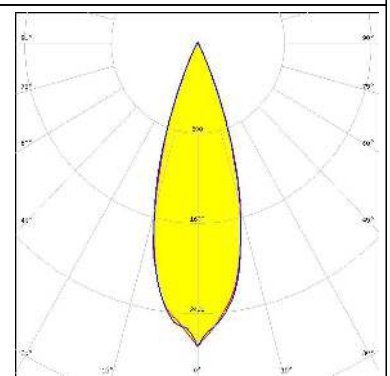
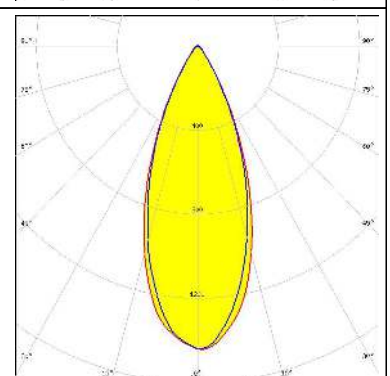
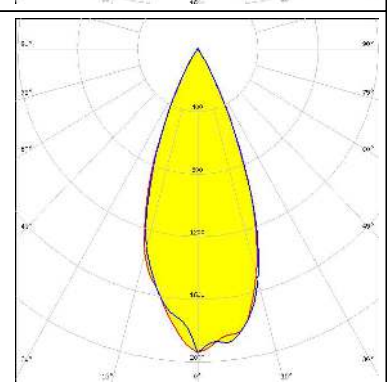

### OPTICAL RESULTS (SIMULATED):

<p><b>NICHIA</b></p> <p>LED NVSW219F            FWHM / FWTM 46.0° / 65.0°            Efficiency 86 %            Peak intensity 1.6 cd/lm            LEDs/each optic 1            Light colour White            Required components:</p>	
<p><b>NICHIA</b></p> <p>LED NVSxE21A            FWHM / FWTM 32.0° / 50.0°            Efficiency 81 %            Peak intensity 2.7 cd/lm            LEDs/each optic 1            Light colour White            Required components:</p>	
<p><b>OSRAM</b>  <small>Opto Semiconductors</small></p> <p>LED Duris S8            FWHM / FWTM 39.0° / 69.0°            Efficiency 77 %            Peak intensity 1.4 cd/lm            LEDs/each optic 1            Light colour White            Required components:</p>	
<p><b>OSRAM</b>  <small>Opto Semiconductors</small></p> <p>LED OSLOM Square CSSRM2/CSSRM3            FWHM / FWTM 41.0° / 60.0°            Efficiency 86 %            Peak intensity 2 cd/lm            LEDs/each optic 1            Light colour White            Required components:</p>	



### OPTICAL RESULTS (SIMULATED):

#### OSRAM

Opto Semiconductors

LED OSLON Square CSSRM2/CSSRM3  
 FWHM / FWTM 36.0° / 58.0°  
 Efficiency 86 %  
 Peak intensity 2.1 cd/lm  
 LEDs/each optic 1  
 Light colour White  
 Required components:

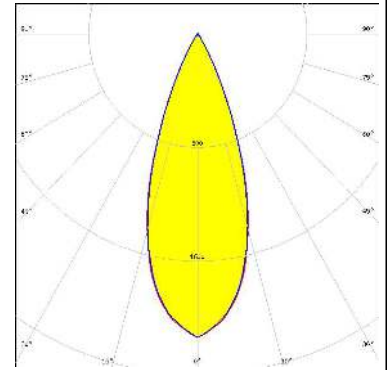

#### SAMSUNG

LED LH351B  
 FWHM / FWTM 45.0° / 64.0°  
 Efficiency 87 %  
 Peak intensity 1.7 cd/lm  
 LEDs/each optic 1  
 Light colour White  
 Required components:

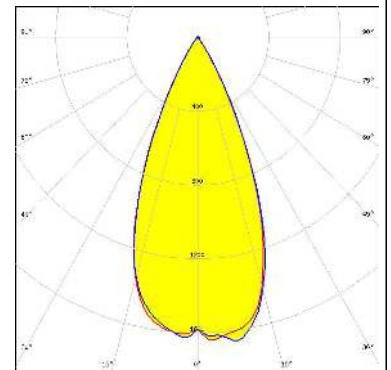

#### SAMSUNG

LED LH351B  
 FWHM / FWTM 44.0° / 64.0°  
 Efficiency 86 %  
 Peak intensity 1.7 cd/lm  
 LEDs/each optic 1  
 Light colour White  
 Required components:

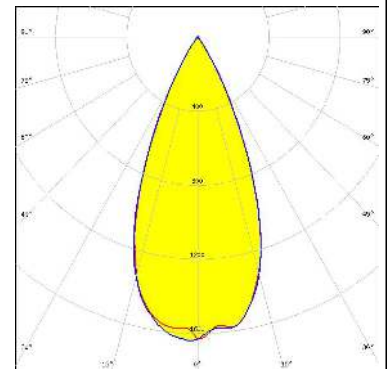

#### SAMSUNG

LED LH351C  
 FWHM / FWTM 45.0° / 65.0°  
 Efficiency 87 %  
 Peak intensity 1.6 cd/lm  
 LEDs/each optic 1  
 Light colour White  
 Required components:

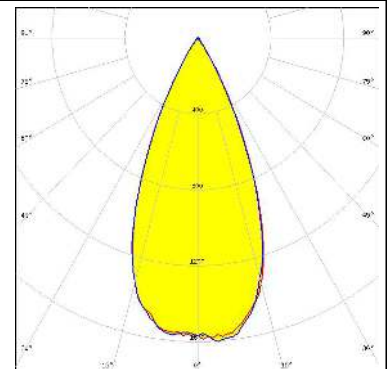

### OPTICAL RESULTS (SIMULATED):



### GENERAL INFORMATION:

NOTE: The typical beam angle will be changed by different color, chip size and chip position tolerance. The typical total beam angle is the full angle measured where the luminous intensity is half of the peak value.

### MATERIALS:

As part of our continuous research and improvement processes, and to ensure the best possible quality and availability of our products, LEDiL reserves the right to change material grades without notice.

### PRODUCT DATA USER AGREEMENT AND DISCLAIMER:

The measured data in the provided downloadable LEDiL Product Datasheets and Mechanical 2D-Drawings is rounded and provided as reference for planning. LEDiL Oy's optical specifications have been verified by conducting performance testing of the products in accordance with the company's quality system. The reported data are averaged results of multiple measurements with typical variation. LEDiL Oy reserves the right to without prior notification make changes and improvements to its products.

LEDiL Oy assumes neither warranty, nor guarantee nor any other liability of any kind for the contents and correctness of the provided data. The provided data has been generated with highest diligence but the provided data may in reality not represent the complete possible variation range of all intrinsic parameters. Therefore, in certain cases a deviation from the provided data could occur.

LEDiL Oy reserves the right to undertake technical changes of its products without further notification which could lead to changes in the provided data. LEDiL Oy assumes no liability of any kind for the possible deviation from any provided data or any other damage resulting from the usage of the provided data.

The user agrees to this disclaimer and user agreement with the download or usage of the provided files.

#### LEDiL Oy

Joensuunkatu 13  
FI-24240 SALO  
Finland

#### LEDiL Inc.

228 West Page Street  
Suite D  
Sycamore IL 60178  
USA

#### Ledil Optics Technology (Shenzhen) Co., Ltd.

# 405 , Block B  
Casic Motor Building  
Shenzhen 518057  
P.R.CHINA

#### Local sales and technical support

[www.ledil.com/  
where\\_to\\_buy](http://www.ledil.com/where_to_buy)

#### Shipping locations

Salo, Finland  
Hong Kong, China

#### Distribution Partners

[www.ledil.com/  
where\\_to\\_buy](http://www.ledil.com/where_to_buy)