

Specification

- Part No. : **PC27.07.0100A**
- Product Name : **TheStripe™** 850 / 900 / 1800 / 1900 MHz GSM
PCB Antenna
W/100mm IPEX 1.13mm Diameter MHF I
Connector
- Feature : 34mm*7mm*0.8mm
850 / 900 / 1800 / 1900MHz GSM
Compatible with Hirose U.FL
RoHS Compliant



1. Introduction

This miniaturized low profile PCB antenna is based on smart TheStripe™ antenna technology. It consists of a PCB antenna and 1.13mm co-axial cable with IPEX MHFI (U.FL) connector.

2. Specification

ELECTRICAL				
Frequency (MHz)	824 ~ 896	880~960	1710~1880	1850~1990
Free Space Peak Gain	-4.1dBi	-13dBi	0.6dBi	-0.4dBi
Free Space Efficiency	13%	8%	51%	11%
Impedance	50Ω			
Polarization	Linear			
Radiation Pattern	Omni			
MECHANICAL				
Antenna Dimensions	34 x 7 x 0.8mm			
Cable	1.13 co-axial			
Connector	IPEX MHF I			
ENVIRONMENTAL				
Operation Temperature	-40°C to 85°C			
Humidity	Non-condensing 65°C 95% RH			

3. S11 Property

3.1. Return Loss

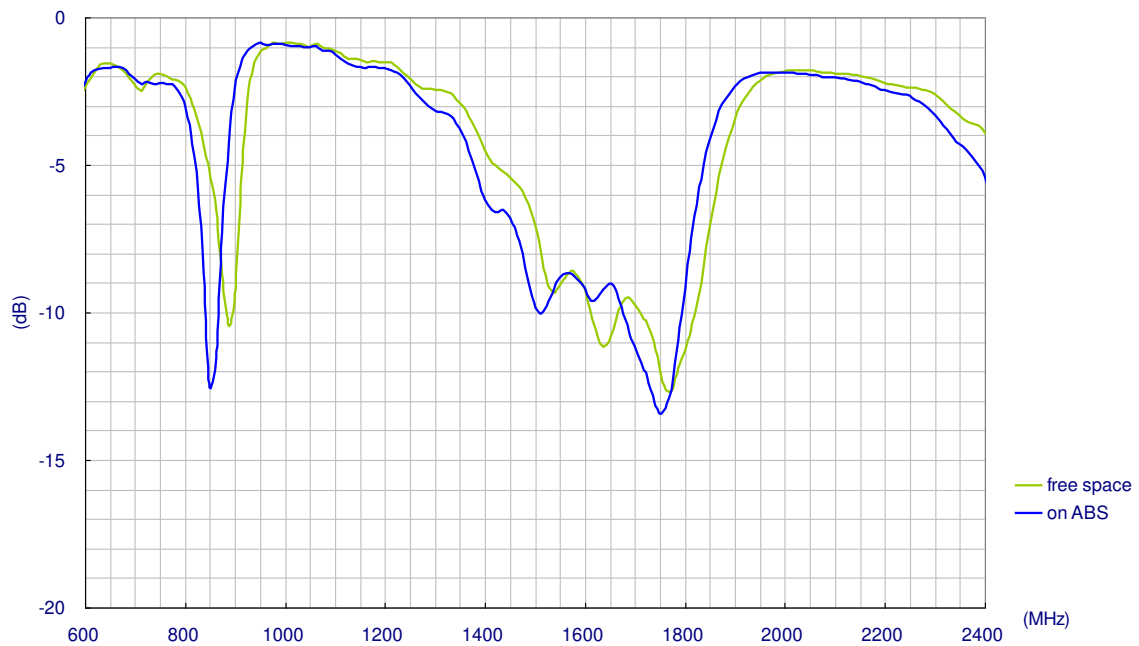

3.2. VSWR

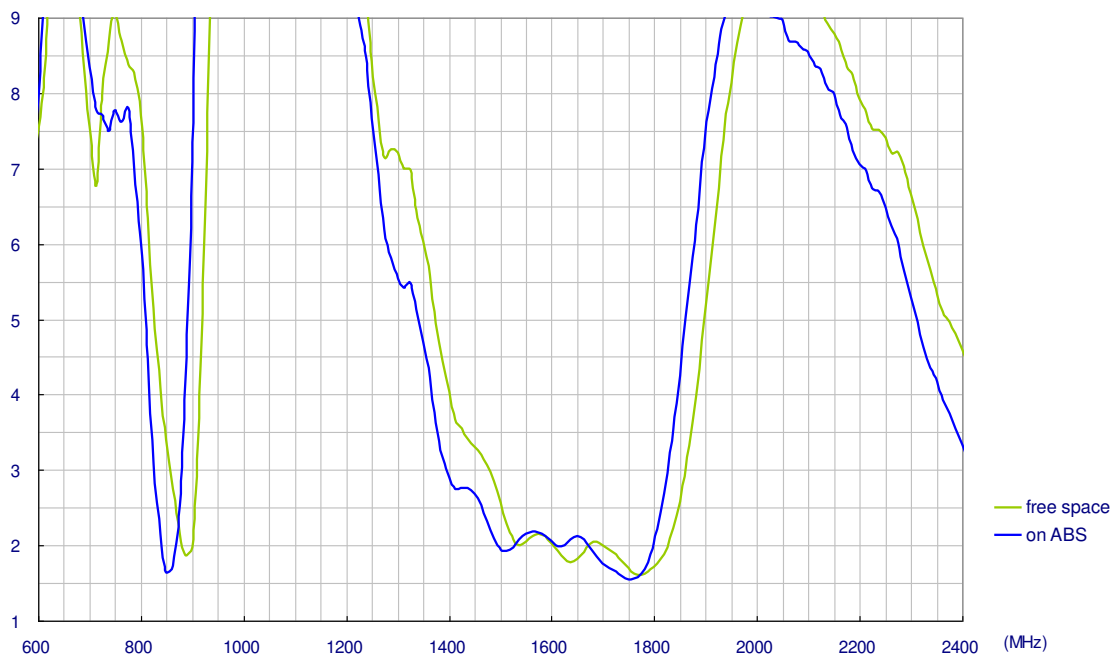

3.3. Efficiency

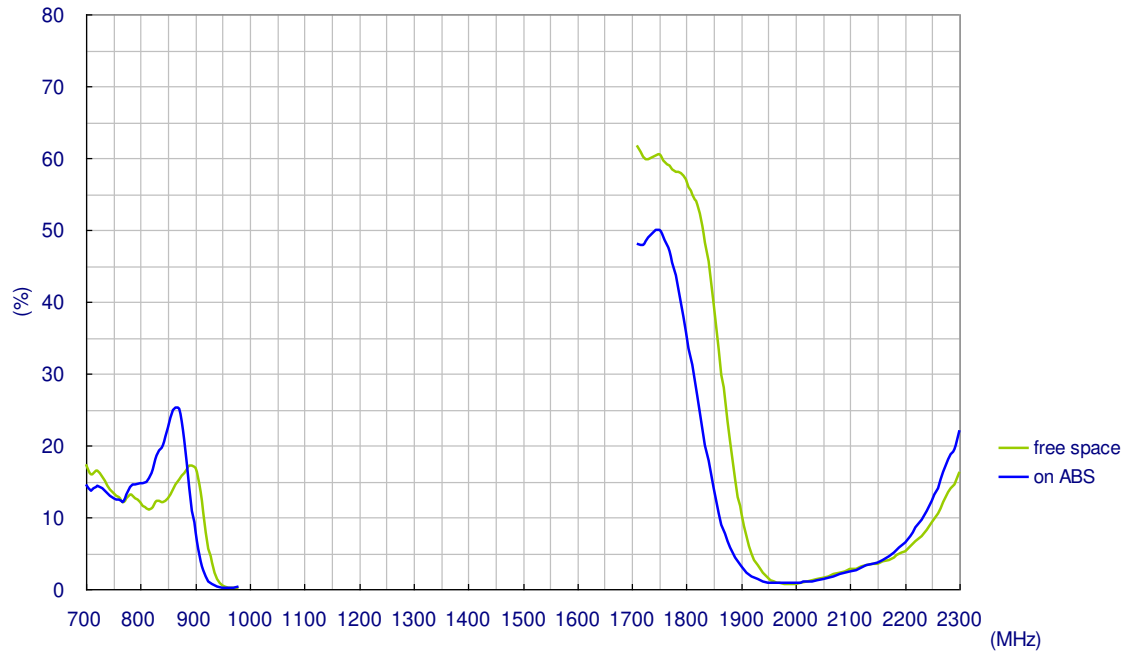

3.4. Peak Gain

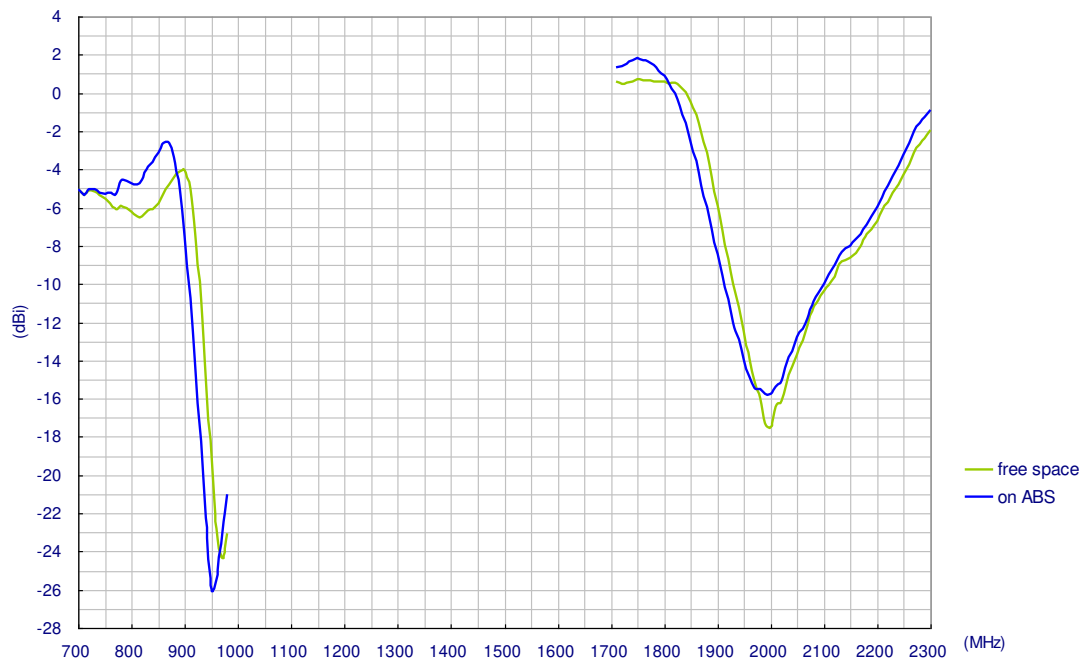

3.5. Average Gain

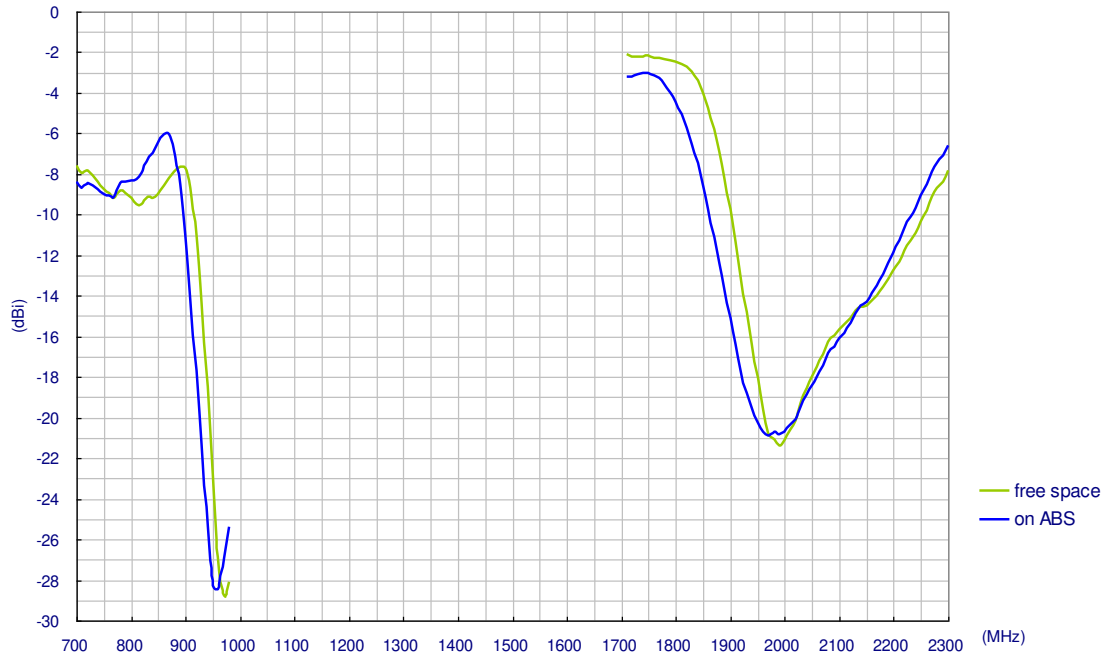

4. Antenna Radiation Pattern

4.1. Radiation Pattern in Free Space

4.1.1. E-plane Radiation

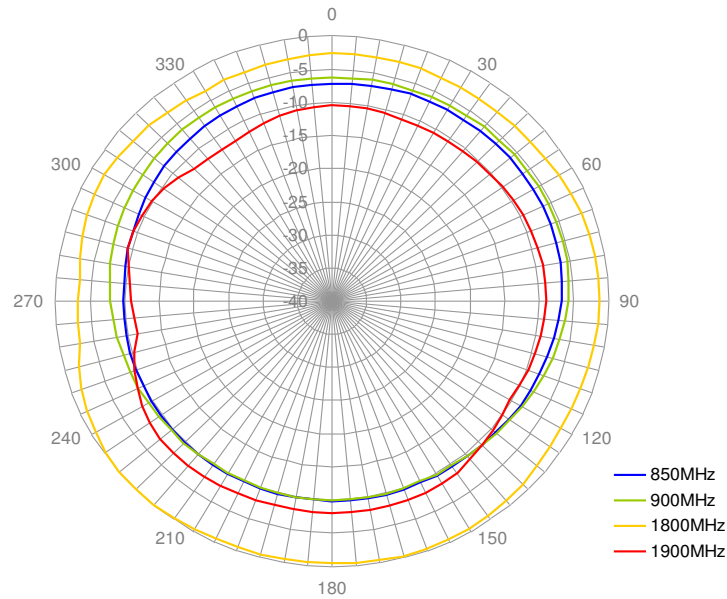

4.1.2. H-plane Radiation

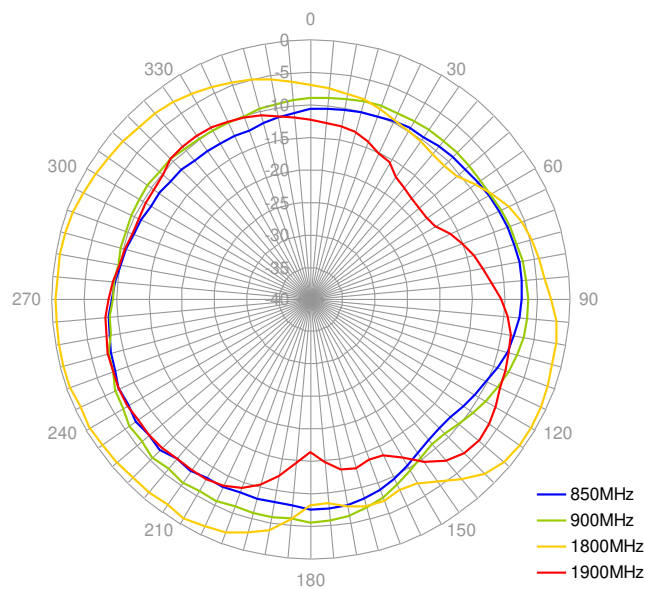

4.2. Radiation Pattern on ABS

4.2.1. E-plane Radiation

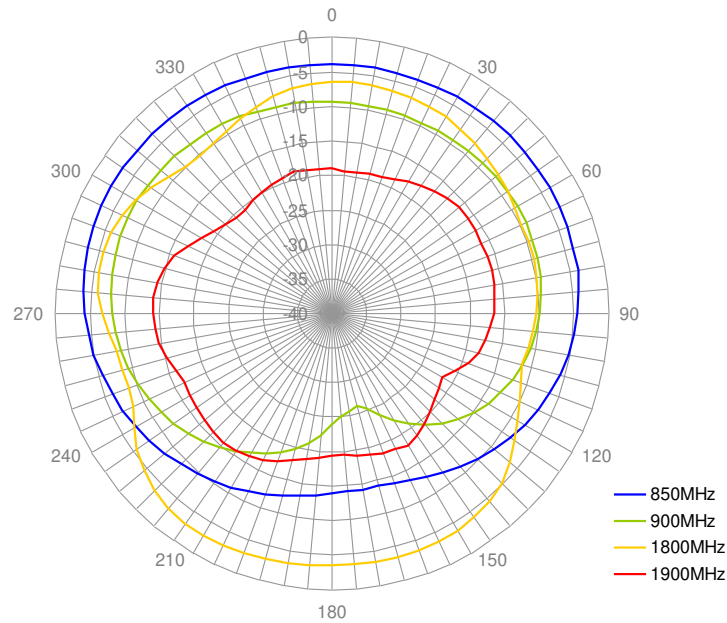

4.2.2. H-plane Radiation

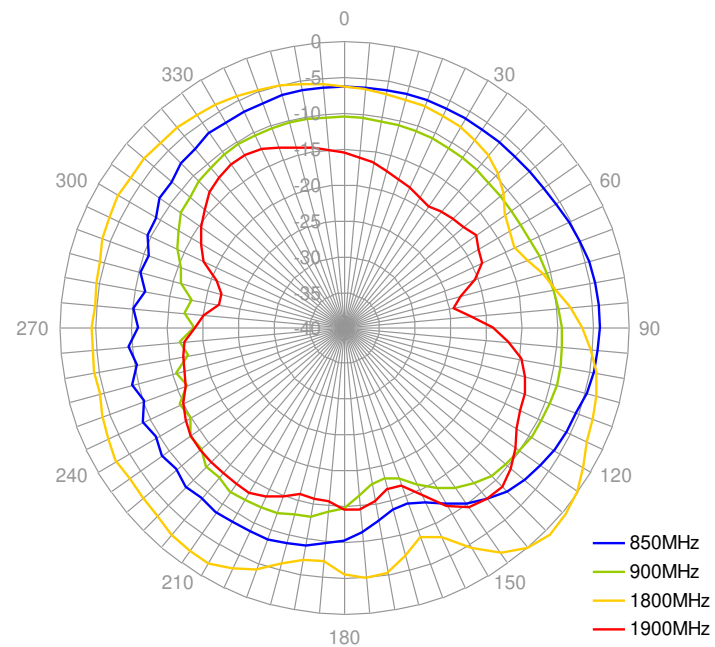

5. Drawing

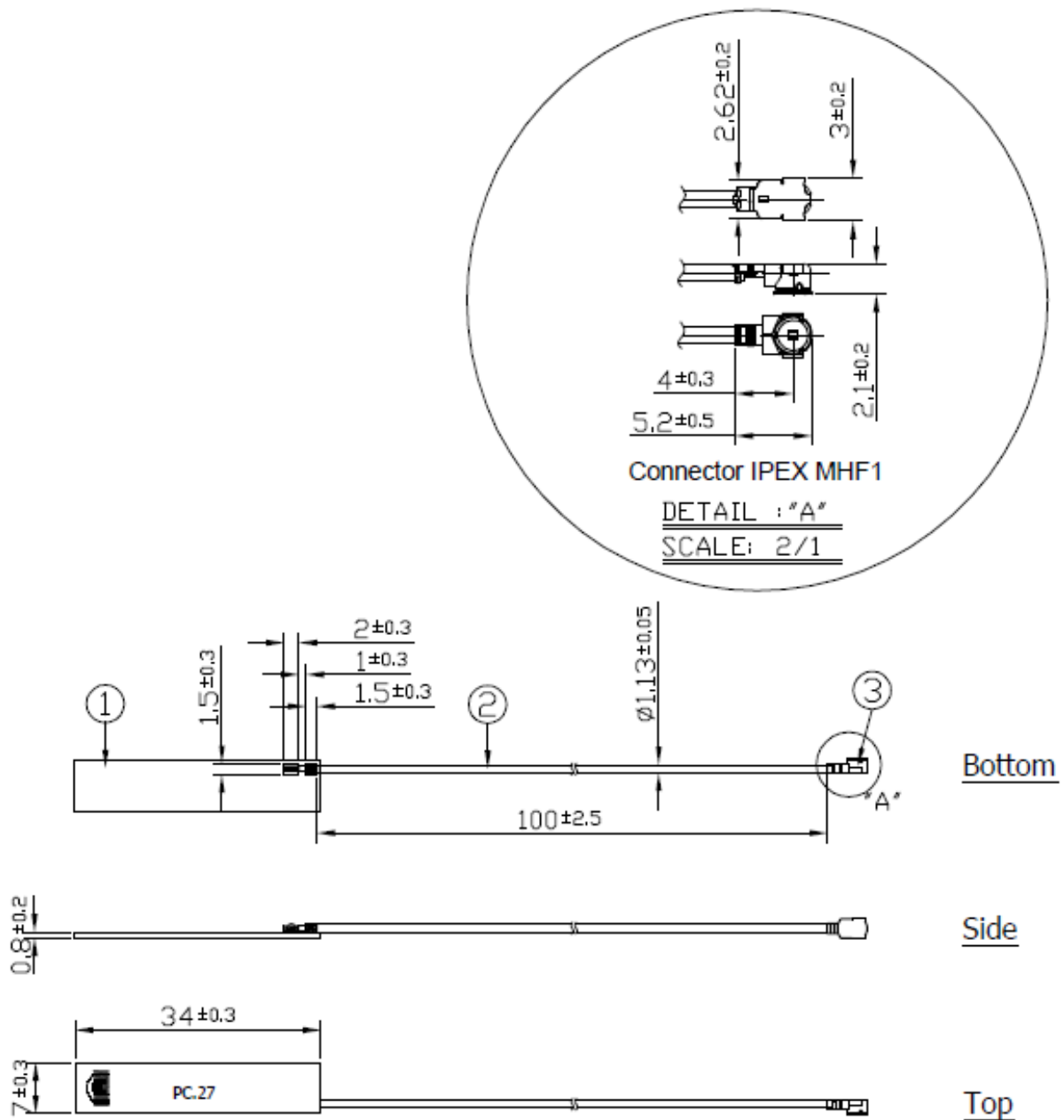

	Name	Material	Finish	QTY
1	PC27 PCB	FR4.08t	Black	1
2	1.13 Coaxial Cable	FEP	Black	1
3	IPEX MHF1	Brass	Gold	1

All material must be RoHS compliant.
 Open/Short QC, VSWR required.

6. Packaging

100pc PC27.09.0100A per PE Bag
 Bag Dimensions - 285 x 160mm
 Weight - 240g

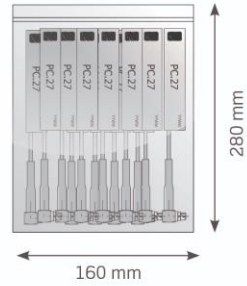

500pcs PC27.07.0100A per PE Large Bag
 Bag Dimensions - 450 x 280mm
 Weight - 1.2kg

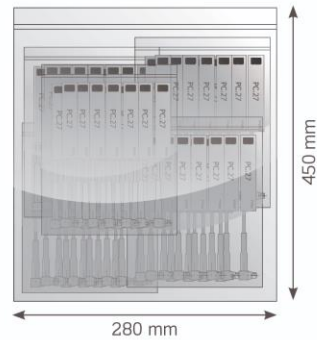

2000 pcs PC27.07.0100A per carton
 Carton - 320 x 250 x 230mm
 Weight - 4.8Kg

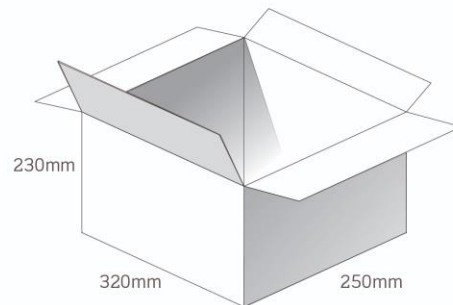

Pallet Dimensions 1200x 1000 x 1350mm
 60 Cartons per Pallet
 12 Cartons per layer
 5 Layers

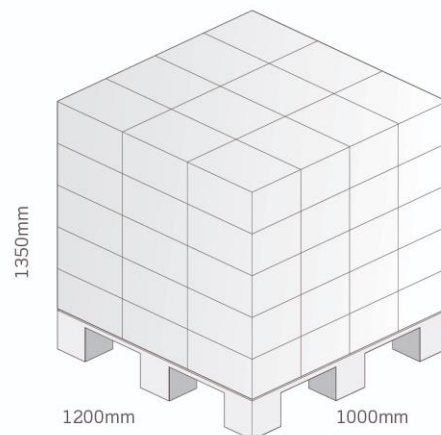

Taoglas makes no warranties based on the accuracy or completeness of the contents of this document and reserves the right to make changes to specifications and product descriptions at any time without notice. Taoglas reserves all rights to this document and the information contained herein.

Reproduction, use or disclosure to third parties without express permission is strictly prohibited.

Copyright © Taoglas Ltd.