

## Dual differential filter with integrated matching for GreenPeak transceiver

Datasheet - production data

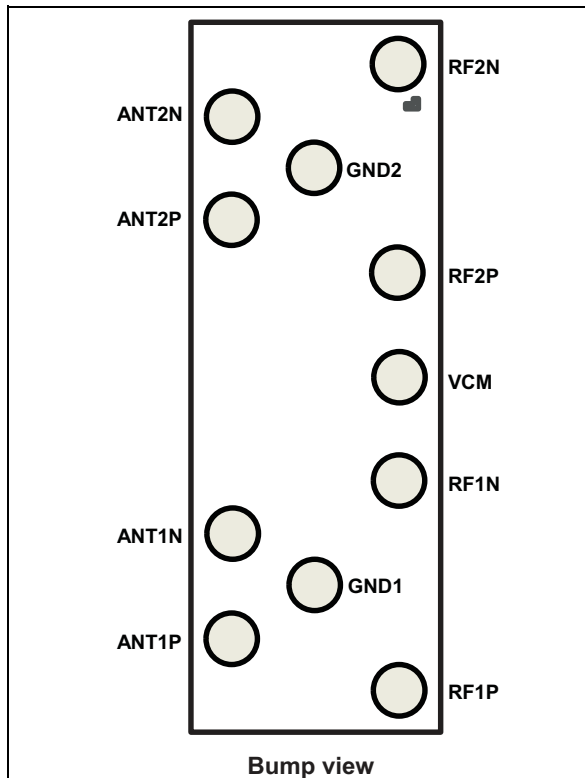

### Description

The DLPF-GP-01D3 is an ultra miniature dual differential filter tailored for GreenPeak Zigbee/RF4CE RF transceivers.

The DLPF-GP-01D3 integrates also matching network and replaces 16 SMD components. Matching impedance has been customized for GreenPeak Zigbee/RF4CE RF transceivers. It is using STMicroelectronics IPD technology on non-conductive Glass substrate which optimize RF performances.

Figure 1. Reference schematic<sup>(a)</sup>

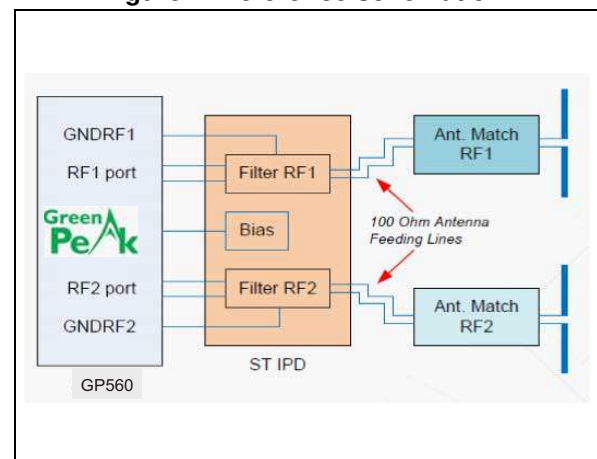

### Features

- Nominal Input / conjugate match to GreenPeak
- Low loss dual-channel differential filter
- Low loss dual-channel common-mode filter
- Small footprint < 1.2 x 3.4 mm<sup>2</sup>
- Very low profile (< 560 μm after reflow)
- High RF performance
- RF BOM and area reduction

### Applications

- 2.45 GHz impedance matched dual-differential filter
- Optimized for GreenPeak GP540 and GP561 circuits

a. Courtesy of GreenPeak.

# 1 Absolute maximum ratings

Table 1. Absolute maximum ratings (limiting value)

Symbol	Parameter	Value			Unit
		Min.	Typ.	Max.	
$P_{IN}$	Input Power RFIN			20	dBm
$V_{ESD}$	ESD Ratings MIL STD883C (HBM: C=100 pF, R=1.5 k $\Omega$ , Air discharge)	800			V
	ESD ratings machine model (MM: C=200 pF, R=25 $\Omega$ , L=500 nH)	550			V
$T_{OP}$	Operating temperature	-40		+80	$^{\circ}$ C

## 2 Electrical characteristics

Table 2. Impedances

Symbol	Parameter	Value			Unit
		Min.	Typ.	Max.	
Z <sub>OUT</sub>	Nominal differential output impedance	-	Conjugate match to GreenPeak IC	-	Ω
Z <sub>IN</sub>	Nominal differential input impedance	-	100	-	Ω

Table 3. RF performance

Symbol	Parameter	Test condition	Value			Unit
			Min.	Typ.	Max.	
T <sub>OP</sub>	Operating temperature	-	-40		+80	°C
f	Frequency range (bandwidth)	-	2400		2500	MHz
I <sub>L</sub>	Insertion loss in bandwidth	T <sub>j</sub> = 25 °C		-1.45	-1.7	dB
R <sub>L_ANT</sub>	Return loss in bandwidth			-16	-11	dB
R <sub>L_IC</sub>	Return loss in bandwidth			-15	-10.5	dB
2f <sub>0</sub>	2f <sub>0</sub> attenuation			-41	-37	dB
3f <sub>0</sub>	3f <sub>0</sub> attenuation			-34	-28	dB

## 2.1 RF measurements (on board)

Figure 2. Differential transmission

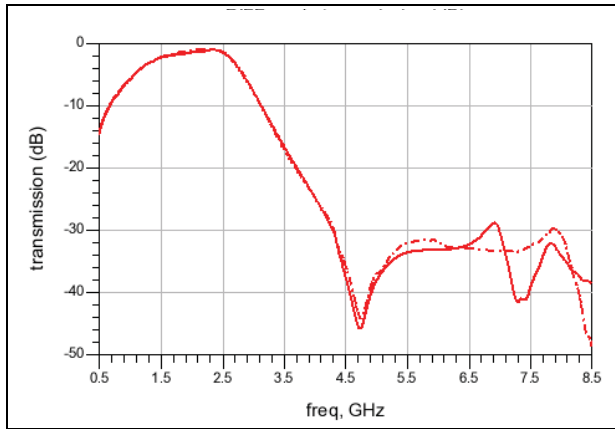

Figure 3. DIFF mode insertion loss (dB)

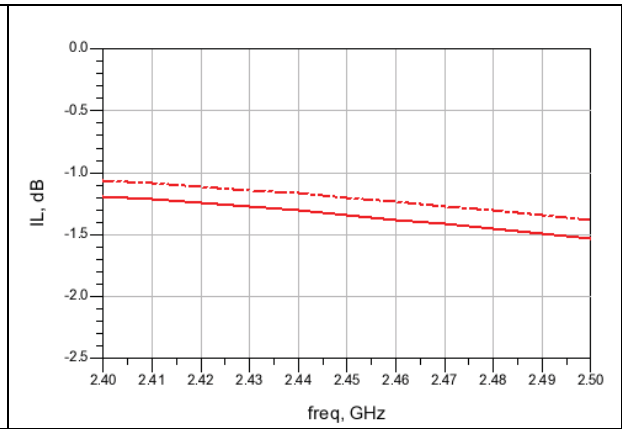

Figure 4. DIFF mode - 2f0 second harmonic (dB)

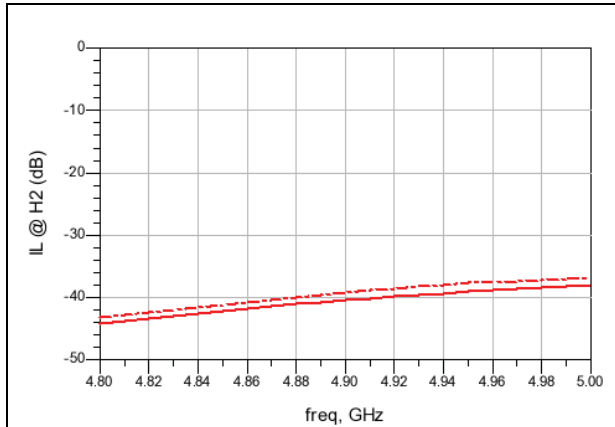

Figure 5. DIFF mode - 3f0 third harmonic (dB)

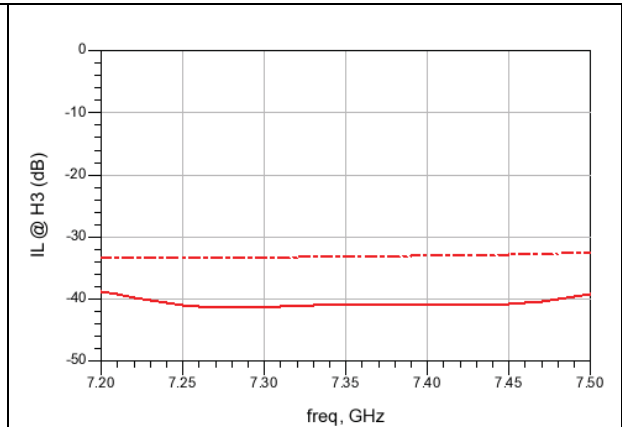

Figure 6. Return loss on ANT side (dB)

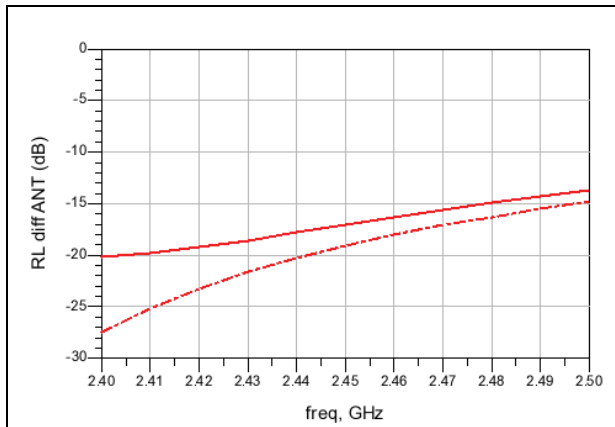
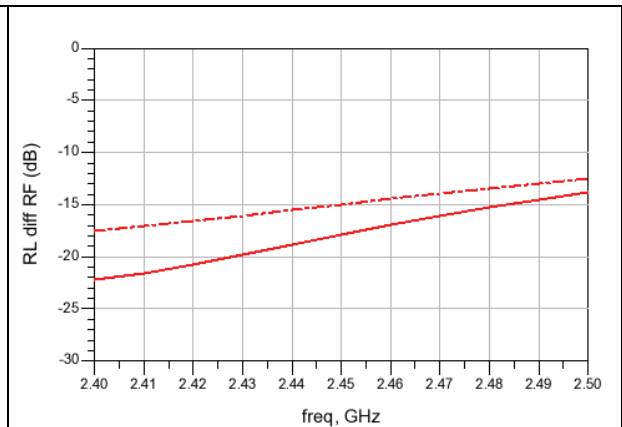

Figure 7. Return loss on IC side (dB)



### 3 Package mechanical data

In order to meet environmental requirements, ST offers these devices in different grades of ECOPACK® packages, depending on their level of environmental compliance. ECOPACK® specifications, grade definitions and product status are available at: [www.st.com](http://www.st.com). ECOPACK® is an ST trademark.

Figure 8. Mechanical specifications (bump view)

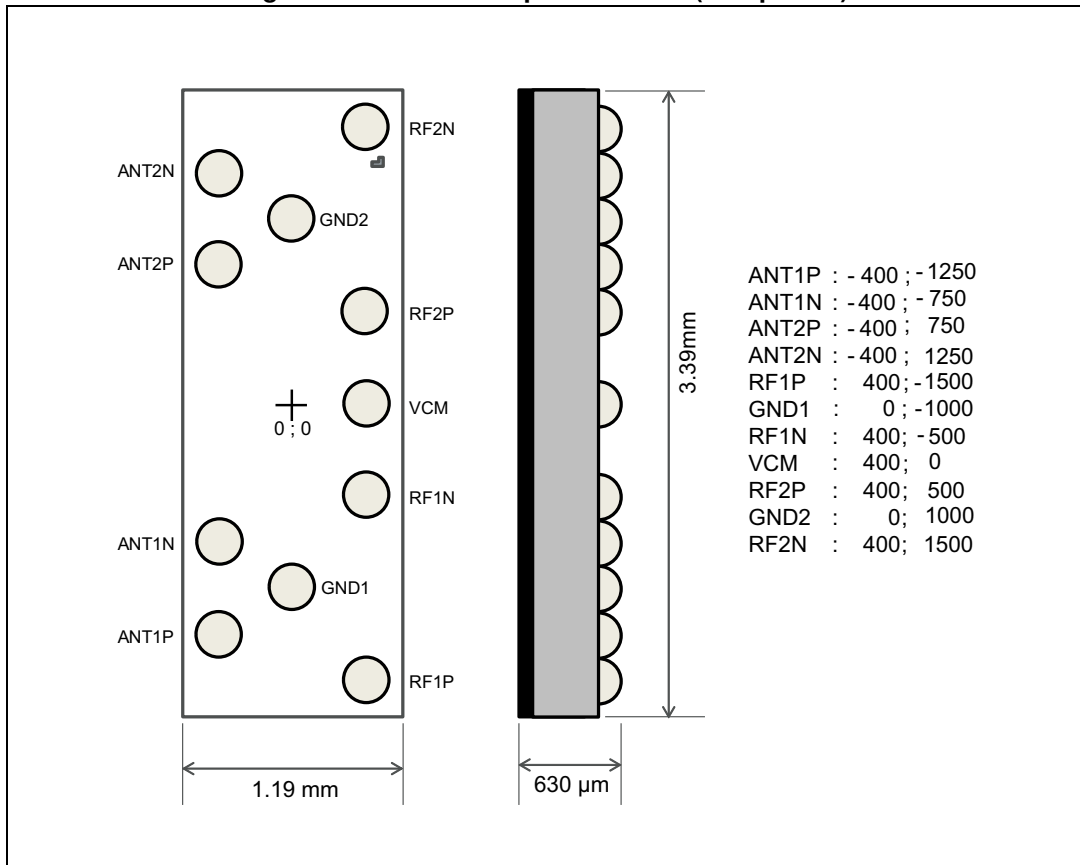
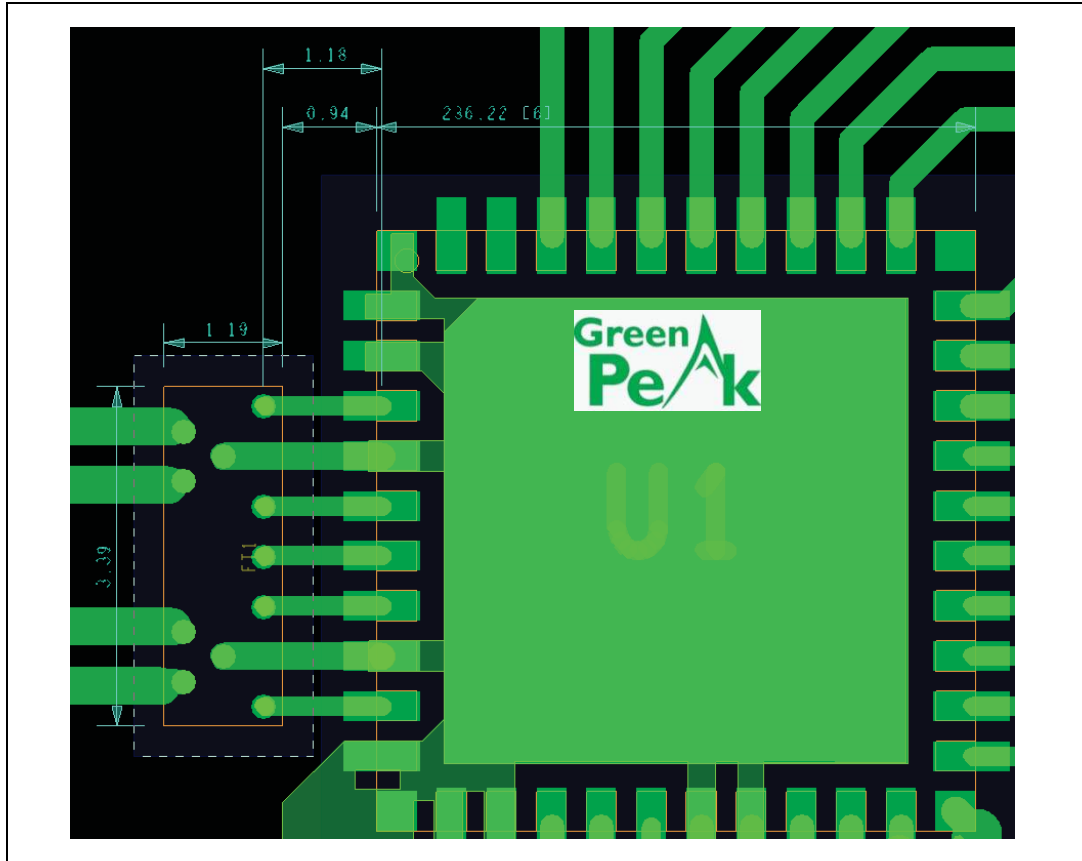

Figure 9. Layout recommendations



No extra components required thanks to DLPF-GP-01D3.

Dimensions (distances) from center pad to center pad (filter GP chip) shall be respected as much as possible in order to avoid any deviation in performances.

Figure 10. Footprint - non solder mask defined      Figure 11. Footprint - solder mask defined

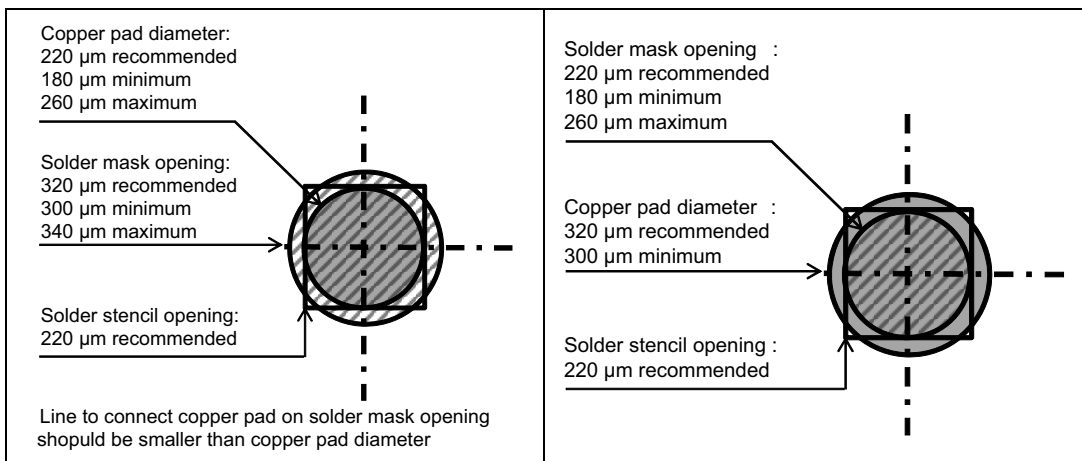

Figure 12. Marking specification

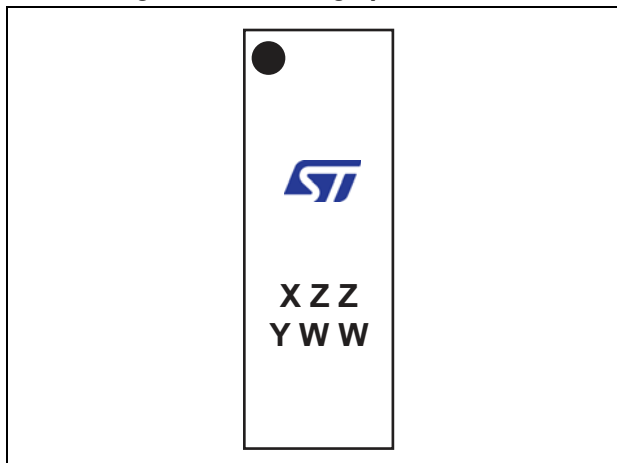

Figure 13. Footprint coordinates

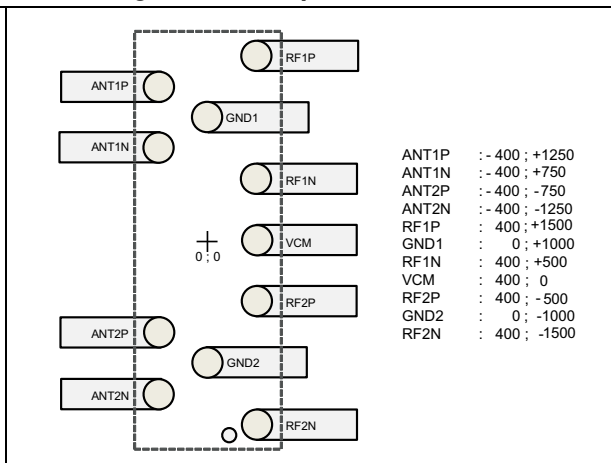
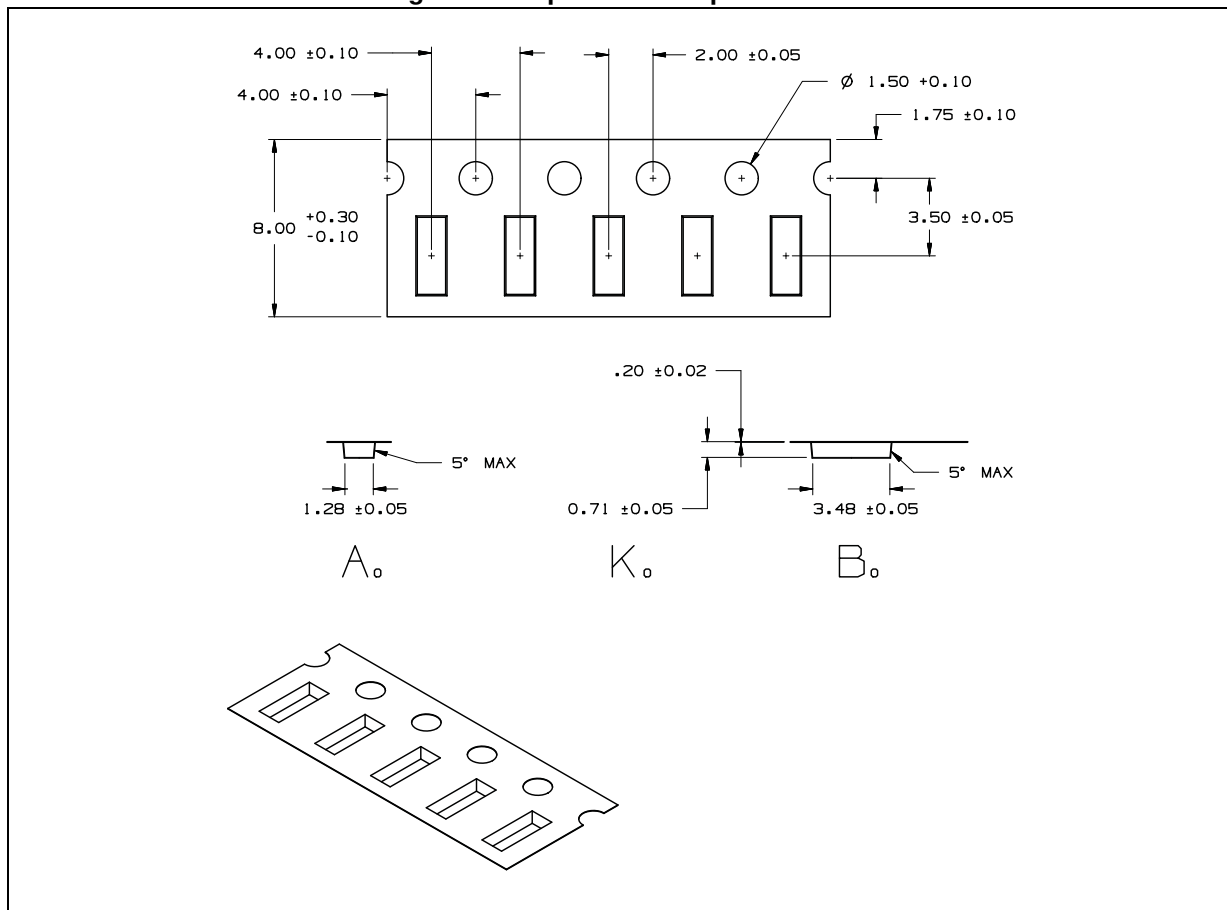

Figure 14. Tape and reel specification



Note: The dimensions shown on this proposed drawing are for illustrative purpose. Dimensions from actual carrier may vary slightly

More information is available in the application notes AN2348: "Flip Chip: Package description and recommendations for use".

## 4 Ordering information

Table 4. Ordering information

Part number	Marking	Weight	Base qty	Delivery mode
DLPF-GP-01D3	SW	4.43 mg	5000	Tape and reel

## 5 Revision history

Table 5. Document revision history

Date	Revision	Changes
10-Oct-2014	1	Initial release.



**IMPORTANT NOTICE – PLEASE READ CAREFULLY**

STMicroelectronics NV and its subsidiaries ("ST") reserve the right to make changes, corrections, enhancements, modifications, and improvements to ST products and/or to this document at any time without notice. Purchasers should obtain the latest relevant information on ST products before placing orders. ST products are sold pursuant to ST's terms and conditions of sale in place at the time of order acknowledgement.

Purchasers are solely responsible for the choice, selection, and use of ST products and ST assumes no liability for application assistance or the design of Purchasers' products.

No license, express or implied, to any intellectual property right is granted by ST herein.

Resale of ST products with provisions different from the information set forth herein shall void any warranty granted by ST for such product.

ST and the ST logo are trademarks of ST. All other product or service names are the property of their respective owners.

Information in this document supersedes and replaces information previously supplied in any prior versions of this document.

© 2014 STMicroelectronics – All rights reserved

