

OMRON



Digital Controller
(Programmable Type)

User's Manual

Cat. No. H088-E1-02

Preface

The E5AK-T is a high-performance programmable digital controller. The E5AK-T allows the user to carry out the following:

- Set program patterns to each step by time or ramp rise rate
- Execute advance, hold and reset step operations
- Execute continuous operation of all patterns and repeated operation of same patterns
- Check the start of each step or program end time by signals.
- Count time from the beginning of each step (time signal)
- Select from many types of temperature and analog input (multi-input)
- Support position-proportional control (position-proportional type controllers only)
- Select output functions such as control output or alarm output (output assignment)
- Use the HBA (heater burnout alarm) function (standard type controllers only)
- Monitor the control loop by LBA (Loop Break Alarm)
- Use the communications function
- Calibrate input or transfer output
- The E5AK-T also features a watertight construction (NEMA4: equivalent to IP66).

This User's Manual describes how to use the E5AK-T.

Before using your E5AK-T thoroughly read and understand this manual in order to ensure correct use.

Also, store this manual in a safe place so that it can be retrieved whenever necessary.

PRECAUTIONS IN USING THE PRODUCT

When the product is used under the circumstances or environment below, ensure adherence to limitations of the ratings and functions. Also, take countermeasures for safety precautions such as fail-safe installations.

- (1) Use under circumstances or environments which are not described in this user's manual.
- (2) Use for nuclear power control, railway, air craft, vehicle, incinerator, medical equipment, entertainment equipment, safety device, etc.
- (3) Use for applications where death or serious property damage is possible and extensive safety precautions are required.

About this manual

- (1) All rights reserved. No part of this publication may be reproduced, stored in a retrieval system or transmitted, in any form, or by any means, mechanical, electronic, photocopying, recording, or otherwise, without the prior written permission of OMRON.
- (2) Moreover, because OMRON is constantly striving to improve its high-quality products, the information in this manual is subject to change without notice.
- (3) Every precaution has been taken in the preparation of this manual. Nevertheless, if you find any errors or omissions, please contact the branch of OMRON or sales office listed at the end of this manual, and inform them of the catalog No. on the front cover.

Conventions Used in This Manual

■ Meanings of Abbreviations

Sometimes the following abbreviations are used in parameter names, figures and in text explanations. These abbreviations mean the following:

Symbol	Term
PV	Process value
SP	(Present) set point *1
LBA	Loop break alarm
HB	Heater burnout
AT	Auto-tuning
EU	Engineering unit *2

*1 In program pattern diagrams, the present SP is indicated.

*2 °C, m, g and other units are indicated for scaled data. However, “EU” is used as the minimum unit for the data. For example, for “50.02 (m)”, 1EU is taken as the minimum unit 0.01 (m).

■ How to Read Display Symbols

The following tables show the correspondence between the symbols displayed on the displays and alphabet characters.

A	b	C	d	E	F	G	H	I	J	K	L	M
A	B	C	D	E	F	G	H	I	J	K	L	M

n	o	P	q	r	S	t	U	v	w	x	y	Z
N	O	P	Q	R	S	T	U	V	W	X	Y	Z

■ “Reference” mark

This mark indicates that extra, useful information follows, such as supplementary explanations and how to apply functions.



■ How This Manual is Organized

Purpose	Title	Description
<ul style="list-style-type: none"> ● Learning about the general features of the E5AK-T 	Chapter 1 INTRODUCTION	This chapter describes the features of the E5AK-T, names of parts, and typical functions.
<ul style="list-style-type: none"> ● Setting up 	Chapter 2 PREPARATIONS	This chapter describes the operations that you must carry out (e.g. installation, wiring and switch settings) before you can use the E5AK-T.
<ul style="list-style-type: none"> ● Basic E5AK-T operations 	Chapter 3 BASIC OPERATION Chapter 5 PARAMETERS	These chapters describe using basic control examples how to use the front panel keys and how to view the display when setting the parameters of the major functions for the E5AK-T.
<ul style="list-style-type: none"> ● Applied E5AK-T operations 	Chapter 4 APPLIED OPERATION Chapter 5 PARAMETERS	These chapters describes the important functions of the E5AK-T and how to use the parameters for making full use of the E5AK-T.
<ul style="list-style-type: none"> ● Using a Position-proportional type controller 	Chapter 4 APPLIED OPERATION /4.1 Selecting the Control Method	This chapter describes how to use the functions related specifically to position-proportional type controllers.
<ul style="list-style-type: none"> ● Communications with a host computer 	Chapter 6 USING THE COMMUNICATIONS FUNCTION	This chapter mainly describes how to use the communications commands, and gives program examples.
<ul style="list-style-type: none"> ● Calibration 	Chapter 7 CALIBRATION	This chapter describes how the user should calibrate the E5AK-T.
<ul style="list-style-type: none"> ● Troubleshooting 	Chapter 8 TROUBLESHOOTING	This chapter describes what to do if any problems occur.

PRECAUTIONS ON SAFETY

● Marks For Ensuring Safe Use and Their Meanings

This manual uses the following marks to indicate precautions for ensuring that the E5AK-T is used safely.

The precautions indicated below describe important information regarding safety. Be sure to follow the instructions described in these precautions.



WARNING

Incorrect handling may cause death or injury.



WARNING

Do not touch the terminals while the power is ON.
This may cause an electric shock.

NOTICE

Be sure to observe these precautions to ensure safe use.

- Do not use the product in places where explosive or flammable gases may be present.
- Never disassemble, repair or modify the product.
- Tighten the terminal screws properly.
- Use the specified size of solderless terminals for wiring.
- Use the product within the rated supply voltage.
- Use the product within the rated load.
- The life expectancy of the output relay varies considerably according to its switching capacity and operating conditions. Be sure to use the output relay within its rated load and electrical life expectancy. If the output relay is used beyond its life expectancy, its contacts may become fused or burned.
- If you remove the controller from its case, never touch nor apply shock to the electronic parts inside.
- Do not cover the E5AK-T. (Ensure sufficient space around the controller to allow heat radiation.)
- Do not use the controller in the following places:
 - Places subject to icing, condensation, dust, corrosive gas (especially sulfide gas or ammonia gas).
 - Places subject vibration and large shocks.
 - Places subject to splashing liquid or oil atmosphere.
 - Places subject to intense temperature changes.
 - Places subject to heat radiation from a furnace.
- Be sure to wire properly with correct polarity of terminals.
- When wiring input or output lines to your controller, keep the following points in mind to reduce the influence from inductive noise:
 - Allow adequate space between the high voltage/current power lines and the input/output lines.
 - Avoid parallel or common wiring with high voltage sources and power lines carrying large currents.
 - Using separating pipes, ducts, and shielded line is also useful in protecting the controller, and its lines from inductive noise.
- Cleaning: Do not use paint thinner or organic solvents. Use standard grade alcohol to clean the product.
- Use a voltage (100 to 240 VAC at 50 to 60 Hz). At power ON, the prescribed voltage level must be attained within two seconds.
- Allow as much space as possible between the controller and devices that generate a powerful high frequency (high-frequency welders, high-frequency sewing machines, etc.) or surge. These devices may cause malfunctions.
- If there is a large power-generating peripheral device and any of its lines near the controller, attach a surge suppressor or noise filter to the device to stop the noise affecting the controller system. In particular, motors, transformers, solenoids and magnetic coils have an inductance component, and therefore can generate very strong noise.
- When mounting a noise filter on the power supply to the controller, be sure to first check the filter's voltage and current capacity, and then mount the filter as close as possible to the controller.

- Use within the following temperature and humidity ranges:
 - Temperature: -10°C to 55°C , humidity: 35%RH to 85%RH (with no icing or condensation)
If the controller is installed inside a control board, the ambient temperature must be kept to under 55°C , including the temperature around the controller.
If the controller is subjected to heat radiation, use a fan to cool the surface of the controller to under 55°C .
- Store within the following temperature and humidity ranges:
 - Temperature: -25°C to 65°C , humidity: 35%RH to 85%RH (with no icing or condensation)
- Never place heavy objects on, or apply pressure to the controller that may cause it to deform and deteriorate during use or storage.
- Avoid using the controller in places near a radio, television set, or wireless installation. These devices can cause radio disturbances which adversely affect the performance of the controller.

Table of Contents

Preface	I
Conventions Used in This Manual	II
Precautions on Safety	V

CHAPTER 1 INTRODUCTION 1-1

This chapter introduces the names of parts on the E5AK-T and their functions. For details on how to use the controller and parameter settings, see Chapter 2 onwards.

1.1 Names of parts	1-2
1.2 Input and Output	1-5
1.3 Program	1-8
1.4 Parameters and Menus	1-9
1.5 About the Communications Function	1-12
1.6 About Calibration	1-13

CHAPTER 2 PREPARATIONS 2-1

This chapter describes the operations (e.g. setup, installation and wiring) you should carry out before turning the E5AK-T ON.

2.1 Setup	2-2
2.2 Installation	2-5
2.3 Wiring Terminals	2-8

CHAPTER 3 BASIC OPERATION 3-1

This chapter describes actual examples for understanding the basic operation of the E5AK-T.

3.1 Convention Used in this Chapter	3-2
3.2 Setting Input Specifications	3-4
3.3 Setting Output Specifications	3-7
3.4 Setting Alarm Type	3-10
3.5 Setting Patterns	3-14
3.6 Protect Mode	3-19
3.7 Starting and Stopping Operation	3-21
3.8 Adjusting Control Operation	3-22

CHAPTER 4 APPLIED OPERATION 4-1

This chapter describes each of the parameters required for making full use of the features of the E5AK-T. Read this chapter while referring to the parameter descriptions in chapter 5.

4.1 Selecting the Control Method	4-2
4.2 Operating Condition Restrictions	4-7
4.3 Ramp Rise Rate Setup Program	4-9
4.4 Program Operation	4-13

4.5	Wait Operation	4-16
4.6	Program output	4-17
4.7	Setting Running Conditions	4-19
4.8	How to Use Event Input	4-21
4.9	How to Use the Heater Burnout Alarm	4-23
4.10	LBA	4-26
4.11	How to Use Transfer Output	4-28
 CHAPTER 5 PARAMETERS		5-1
<p style="margin-left: 40px;">This chapter describes the parameters of the E5AK-T. Use this chapter as a reference guide.</p>		
	Conventions Used in this Chapter	5-2
	Protect Mode	5-3
	Manual Mode	5-5
	Level 0 Mode	5-6
	Program Mode	5-11
	Level 1 Mode	5-17
	Level 2 Mode	5-24
	Setup Mode	5-30
	Expansion Mode	5-38
	Option Mode	5-46
	Calibration Mode	5-52
 CHAPTER 6 USING THE COMMUNICATIONS FUNCTION ..		6-1
<p style="margin-left: 40px;">This chapter mainly describes communications with a host computer and communications commands.</p>		
6.1	Outline of the Communications Function	6-2
6.2	Preparing for Communications	6-3
6.3	Command Structure	6-5
6.4	Commands and Responses	6-7
6.5	How to Read Communications Error Information	6-15
6.6	Program Example	6-17
 CHAPTER 7 CALIBRATION		7-1
<p style="margin-left: 40px;">This chapter describes procedures for each calibration operation. Read this chapter only when the controller must be calibrated.</p>		
7.1	Parameter Structure	7-2
7.2	Calibrating Thermocouples	7-4
7.3	Calibrating Platinum Resistance Thermometers	7-7
7.4	Calibrating Current Input	7-9
7.5	Calibrating Voltage Input	7-10

7.6	Checking Indication Accuracy	7-12
-----	------------------------------------	------

CHAPTER 8 TROUBLESHOOTING 8-1

This chapter describes how to find out and remedy the cause if the E5AK-T does not function properly.

Remedy E5AK-T trouble in the order of the descriptions in this chapter

8.1	Initial Checks	8-2
8.2	How to Use the Error Display	8-3
8.3	How to Use the Error Output	8-5
8.4	Checking Operation Restrictions	8-6

APPENDIX

SPECIFICATIONS	A-2
ABOUT CURRENT TRANSFORMER (CT) ...	A-5
CONTROL BLOCK DIAGRAM	A-6
SETTING LIST	A-8
MODEL LIST	A-12
PARAMETER OPERATIONS LIST	A-13
ASCII CODE LIST	A-15

INDEX

REVISION HISTORY

K CHAPTER 1

INTRODUCTION

This chapter introduces the names of parts on the E5AK-T and their functions.

For details on how to use the controller and parameter settings, see Chapter 2 onwards.

1.1	Names of parts	1-2
	Main parts	1-2
	Front panel	1-2
	About the displays	1-3
	How to use keys	1-4
1.2	Input and Output	1-5
	Input	1-5
	Output	1-6
1.3	Program	1-8
	How programs are structured	1-8
	Program operation	1-8
	Alarm output	1-8
	Program output	1-8
1.4	Parameters and Menus	1-9
	Parameter types	1-9
	Selecting modes	1-10
	Selecting parameters	1-11
	Fixing settings	1-11
1.5	About the Communications Function	1-12
1.6	About Calibration	1-13

1.1 Names of parts

■ Main parts

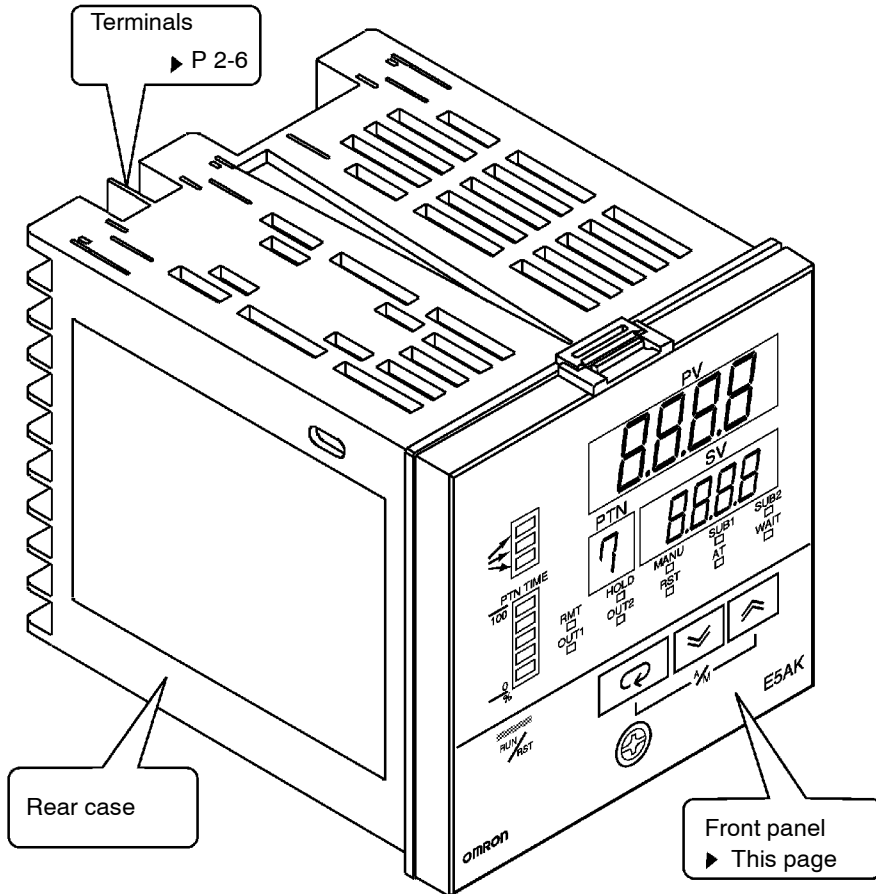

■ Front panel

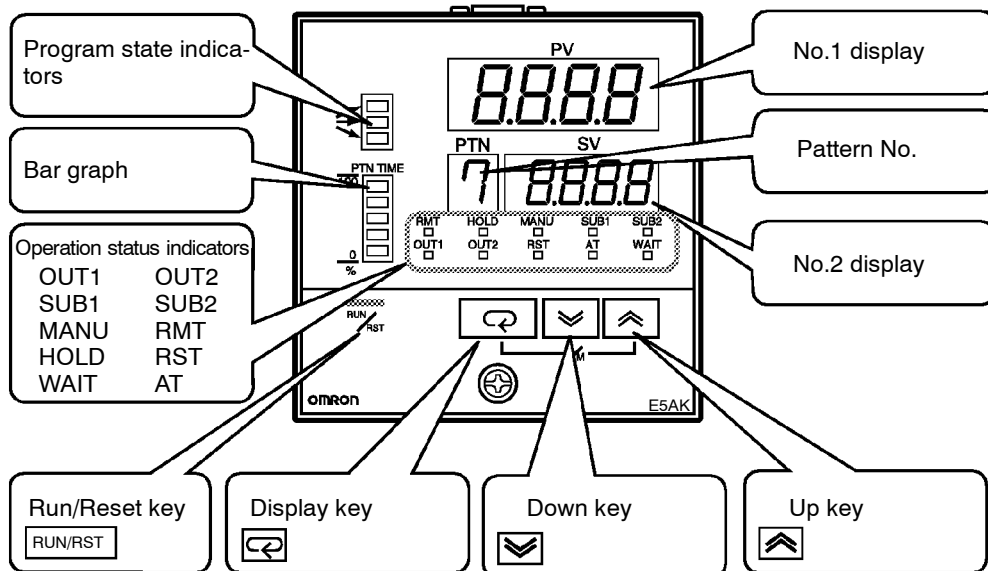

■ About the displays

- **No.1 display** Displays the process value or parameter symbols.
- **No.2 display** Displays the set point, manipulated variable or parameter settings.
- **Pattern No.** Displays pattern No..
- **Program status indicators** Indicate how the present-SP of the operating step changes.
- **Operation status indicators**
 - OUT1
Lights when the pulse output function assigned to “control output 1” is ON.
 - OUT2
Lights when the pulse output function assigned to “control output 2” is ON.
 - SUB1
Lights when the pulse output function assigned to “auxiliary output 1” is ON.
 - SUB2
Lights when the pulse output function assigned to “auxiliary output 2” is ON.
 - MANU
Lights in the manual operation mode.
 - RST
Lights when the control is in reset status.
 - RMT
Lights during remote operation.
 - HOLD
Lights when the program is in hold status.
 - WAIT
Lights when the program is in wait status.
 - AT
Flashes during auto-tuning.
- **Bar graph** • This bar graph indicates how much of the pattern has elapsed in 20% increments (five stages) per single segment.

■ How to use keys

The following describes basic key operations.

● key

To change to run operation from the reset status, press this key for one second minimum.



To change to the reset status from run operation, press this key for two seconds minimum.



● key

The functions of this key change according to how long it is pressed. If the key is pressed for less than one second, the parameters are switched. If the key is pressed for one second minimum, the menu display appears. In key operations from here on, “press the key” refers to pressing the key for less than one second.

For details on switching of parameters and menu display items, see page 1-10.

● key

Each press of  key increments or advances the values or settings on the No.2 display, while each press of the  key decrements or returns the values or settings on the No.2 display.

Functions vary, for example, when the  key is held down simultaneously with the  key, or a key is held down continuously. For details, see page 1-10. Also, chapters 3 and 4 describe examples using various key combinations.

1.2 Input and Output

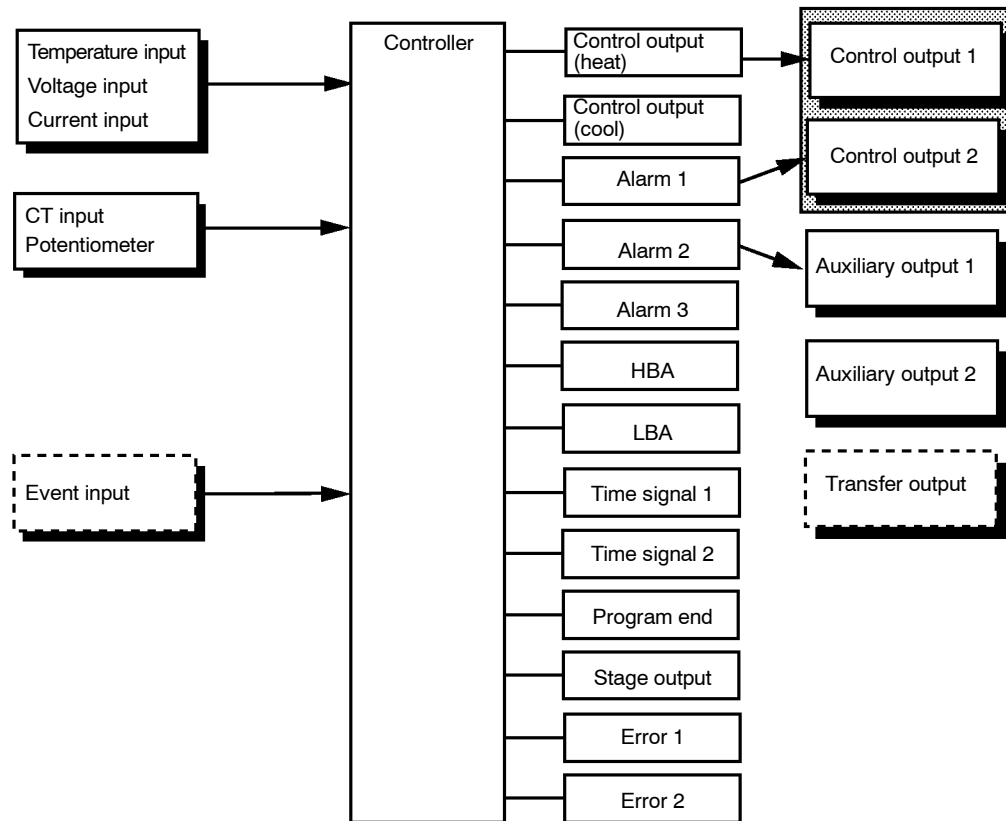

■ Input

The E5AK-T supports the following inputs:

Temperature input, Current input, Voltage input, CT input/potentiometer, and Event input.

● Temperature input/Voltage input/Current input

- Only one of temperature input, current input and voltage input can be selected and connected to the controller.
- The following input sensors can be connected for temperature input:
Thermocouple: K, J, T, E, L, U, N, R, S, B, W, PLII
Platinum resistance thermometer: JPt100, Pt100
- The following currents can be connected for current input:
4 to 20 mA, 0 to 20 mA
- The following voltages can be connected for voltage input:
1 to 5 VDC, 0 to 5 VDC, 0 to 10 VDC

● CT input/Potentiometer

- Connect CT input when using the HBA (heater burnout alarm) function on a standard type controller (E5AK-TAA2). Note that CT input cannot be used when the linear output unit is mounted.
- Connect the potentiometer when monitoring the valve opening on a position-proportional type controller (E5AK-TPRR2).

● Event input

Add on the input unit (E53-CKB) when using event input. You can select from the following six event inputs:

Run/Reset, Remote/Local, Auto/Manual, Hold/Hold Cancel, Advance, Pattern

■ Output

The output functions of the E5AK-T do not operate for five seconds after the E5AK-T is turned ON.

The E5AK-T supports the following five outputs:

Control output 1
Control output 2
Auxiliary output 1
Auxiliary output 2
Transfer output

When using control output 1 and 2, set the output unit (sold separately). Nine output units are available to suit the output circuit configuration.

When using transfer output, add on the communication unit (E53-AKF).

● Output assignments

- The E5AK-T supports the following thirteen output functions: Control output (heat), Control output (cool), Alarms 1 to 3, HBA, LBA, Time Signals 1 and 2, Program End, Stage Output, Error 1 (input error), Error 2 (A/D converter error)
- Assign these output functions to control output 1, control output 2, auxiliary output 1, and auxiliary output 2. However, note that as control output 1 is used as the open output and control output 2 is used as close output on a position-proportional type controller (E5AK-TPRR2), control outputs 1 and 2 cannot be used as assignment destinations. Also, of the output functions, control output (heat), control output (cool), HBA and LBA are disabled.
- On a standard type controller, there are restrictions on how assignment destinations (control output 1, control output 2, auxiliary output 1, and auxiliary output 2) can be used. For details, see Chapter 3 Basic Operation/3.3 Setting Output Specifications (page 3-7).
- In the example on the previous page, “control output (heat)” is assigned to “control output 1”, “alarm 1” is assigned to “control output 2”, and “alarm 2” is assigned to “auxiliary output 1”. Accordingly, the configuration is such that heating control output is connected to control output 1, and alarm output is connected to control output 2 and auxiliary output 1.
- Control outputs 1 and 2 are used depending on the differences in control method as follows:

Control Method	Model	Control Output 1/ Control Output 2
Standard control	E5AK-TAA2 AC100-240 E5AK-TAA2 AC/DC24	Control output (heat) / Alarm, etc.
Heating and cooling control	E5AK-TAA2 AC100-240 E5AK-TAA2 AC/DC24	Control output (heat) / Control output (cool)
Position-proportional control	E5AK-TPRR2 AC100-240 E5AK-TPRR2 AC/DC24	Open/Close

● Transfer output

- The E5AK-T supports the following five transfer outputs:

Set point, Process value, Heating side manipulated variable,

Cooling side manipulated variable, Valve opening

However, note that heating/cooling side manipulated variables can be output only on standard type controllers, and valve opening can be output only on position-proportional type controllers.

- These transfer outputs can be output after being scaled. Setting of an upper limit value smaller than the lower limit value is allowed, so reverse scaling can also be carried out.

1.3 Program

■ How programs are structured

E5AK-T allows you to configure programs made up of a maximum of eight patterns (pattern 0 to 7).

The number of steps (16 maximum) in each pattern can be specified in parameters.

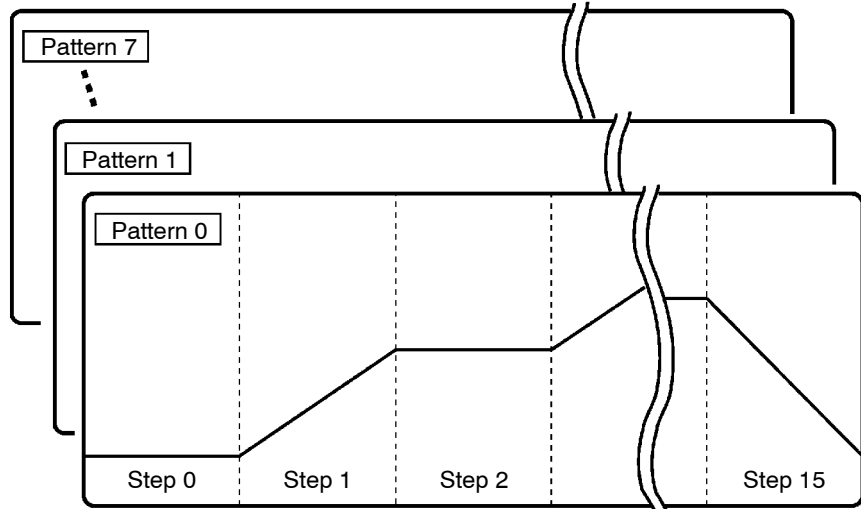

- Generally, the “time setup method” is used to configure programs. By this method, set points at each step and time are used as program elements. However, the “ramp rise rate setup method” can also be used. By this method, the set point, ramp time and soak times are used as program elements.

■ Program operation

● Step operation

● Wait operation

- Generally, the target patterns are specified before the program is executed.
- In parameter setup, you can specify repeated execution of the same pattern (Repeat) or consecutive execution of all patterns 0 to 7 (Run all).
- During program operation, steps can be skipped (Advance) and the control monitoring can be paused (Hold).
- When the wait width is specified in parameter setup, the program does not go to the next step and waits until the PV reaches the specified time (wait width) at the end of each step.

■ Alarm output

■ Program output

- Alarms that are assigned as outputs operate referenced to the alarm values preset to each pattern.
- Time signals, program end and stage output can be output according to output assignment.
- ON/OFF signals are output as time signals according to the timer that takes a specified step as its start point.

1.4 Parameters and Menus

■ Parameter types

E5AK-T parameters are distributed between the following ten modes:

- Protect mode
- Manual mode
- Level 0 mode
- Program mode
- Level 1 mode
- Level 2 mode
- Setup mode
- Expansion mode
- Option mode
- Calibration mode

The settings of parameters in each of eight modes (excluding the protect mode and manual mode) can be checked and modified by selection on the menu display.

● Protect mode

The protect function is for preventing unwanted modification of parameters, and switching between run and reset operation or auto and manual operation.

● Manual mode

In this mode, the controller can be switched to manual operation. The manipulated variable can be manipulated manually only in this mode.

● Level 0 mode

Set the controller to this mode during normal operation. In this mode, you can change the set point and pattern during operation, and execute step operation (e.g. advance). You can only monitor (not change) the process value, step No., standby time, pattern elapsing time, pattern execution count and manipulated variable.

● Program mode

This is the programming mode. In this mode, you can set the number of steps used in each pattern, pattern execution count, alarm values, set points for each step, step time, and time signals for two steps.

● Level 1 mode

This is the main mode for adjusting control. In this mode, you can execute AT (auto-tuning), and set up the control period, PID parameters and heater burnout alarm (HBA) conditions.

● Level 2 mode

This is the auxiliary mode for adjusting control. In this mode, you can set the parameters for limiting the manipulated variable, switch between the remote and local modes, and set the loop break alarm (LBA), alarm hysteresis and the digital filter value of inputs.

● Setup mode

This is the mode for setting the basic specifications. In this mode, you can set parameters that must be checked or set before operation such as the input type, scaling, output assignments and direct/reverse operation.

- **Expansion mode** This is the mode for setting expanded functions. In this mode, you can set SP setting limiter, switching between advanced PID control or ON/OFF control, program time unit, selection of step time/rate of rise programming, time unit of ramp rise rate, and the time for automatic return to the monitoring display.
- **Option mode** This is the mode for setting optional functions. You can select this mode only when an option unit is mounted in the controller. In this mode, you can set the communications conditions, transfer output and event input parameters to match the type of option unit mount in the controller. Heater burnout alarm function and position-proportional travel time are also located in this mode.
- **Calibration mode** This mode is provided so that the user can calibrate inputs and output. When calibrating input, the selected input type is calibrated. Whereas, transfer output can be calibrated only when the communication unit (E53-AKF) is set in the controller.

■ **Selecting modes** The following diagram shows the order in which modes are selected.

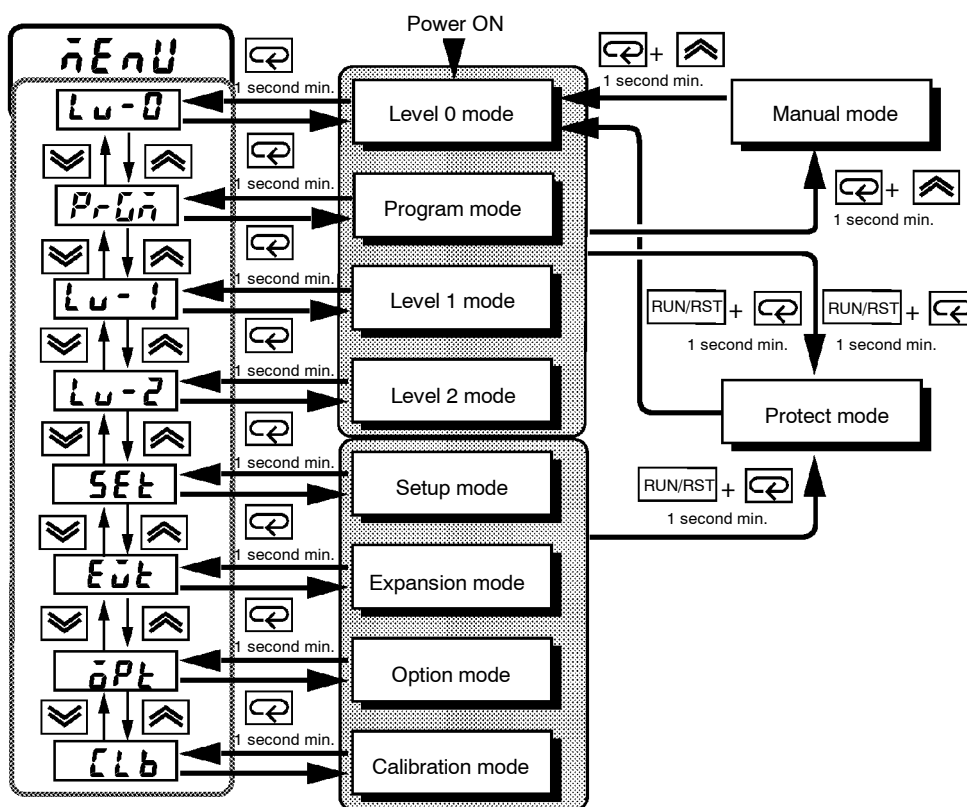

- To select the menu display in any of the above modes (excluding the protect mode and manual mode), press the key for 1 second minimum. When you have selected the menu display, the previous mode is selected. For example, if you selected the menu display while in the level 0 mode, the No.2 display changes to [Lv-0] as shown on the left.
- To move to the desired mode after you have entered the menu display, select the desired mode using the keys and hold down the key for one second minimum. The display switches to the first parameter of the mode that you specified.

- Protected modes cannot be selected. Also, the menu display does not appear when modes are protected up to the program mode.

- If you select [L u - 0], [PrEn], [L u - 1] or [L u - 2] in the menu display, the level 0, program, level 1 and level 2 modes, respectively, are selected.

These modes are selected with control still continuing.

- If you select [SEt] [Ect] [oPt] or [L b] in the menu display, the setup, expansion, option and calibration modes, respectively, are selected.

When these modes are selected, the control is reset. So, control outputs and auxiliary output are turned OFF. When another mode is selected while in these modes control, reset is canceled.

- To set the controller to the protect mode or to return to the level 0 mode from the protect mode, press the [RUN/RST] key and the [↻] key simultaneously for 1 second minimum.
- To set the controller to the manual mode, press the [↗] key for one second minimum with the [↻] key held down in the level 0 to 2 modes. To return to the level 0 mode in the manual mode, press the [↗] key for one second minimum with the [↻] key pressed. Be sure to press the [↻] key first in this operation.

■ Selecting parameters

- When the controller is not in the manual mode, each press of the [↻] key switches the parameter in the respective mode.

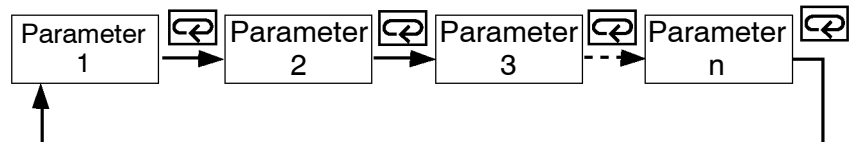

■ Fixing settings

- If you press the [↻] key when at the final parameter, the display returns to the top parameter for the current mode.
- When you change parameter settings or contents, specify the parameter using the [↗] or [↘] keys, and either leave the setting for at least two seconds or press the [↻] key. This fixes the setting.
- When another mode is selected, the content of the parameters before the mode was selected is fixed.
- When you turn the power OFF, you must first fix the settings and parameter contents (by pressing the [↻] key or selecting another mode). The settings and parameter contents are sometimes not changed by merely pressing the [↗] or [↘] keys.

1.5 About the Communications Function

The E5AK-T can be provided with a communications function that allows you to check and set controller parameters from a host computer. If the communications function is required, add on the communications unit.

For details on the communications function, refer to Chapter 6.

- **RS-232C**

When using the communications function on the RS-232C interface, add on the communications unit (E53-AK01).

- **RS-422**

When using the communications function on the RS-422 interface, add on the communications unit (E53-AK02).

- **RS-485**

When using the communications function on the RS-485 interface, add on the communications unit (E53-AK03).

1.6 About Calibration

The E5AK-T controller is calibrated before shipment from the factory. So, the user need not calibrate the E5AK-T controller during regular use.

However, if the E5AK-T controller must be calibrated by the user, use the parameters provided for the user to calibrate temperature input, analog input (voltage, current) and transfer output. In this case, note that the results of calibration will not be assured.

Also, note that calibration data is updated to the latest value each time that the E5AK-T controller is calibrated. Calibration data set before shipment from the factory cannot be returned to after calibration by the user.

● Calibrating inputs

The input type selected in parameters is the item to be calibrated. The E5AK-T is provided with the following four calibration parameters:

- Thermocouple
- Platinum resistance thermometer
- Current input
- Voltage input

Two parameters are provided for thermocouple and voltage input.

● Calibrating transfer output

Transfer output also can be calibrated when the communications unit (E53-AKF) is added on.

● Registering calibration data

When calibrating each item, the calibration data is temporarily registered. This data can be registered as final calibration data only when all items have been newly calibrated. So, all items must be temporarily registered when the E5AK-T controller is calibrated.

When registering data, information regarding whether or not calibration has been carried out is also registered.

To calibrate these items, the user must prepare separate measuring devices and equipment. For details on handling these measuring devices and equipment, refer to the respective manuals.

For details, see Chapter 7 Calibration.

K CHAPTER 2

PREPARATIONS

This chapter describes the operations (e.g. setup, installation and wiring) you should carry out before turning the E5AK-T ON.

2.1	Setup	2-2
	Draw-out	2-2
	Setting up the output unit	2-3
	Setting up the option unit	2-4
2.2	Installation	2-5
	Dimensions	2-5
	Panel cutout	2-5
	Mounting	2-6
2.3	Wiring Terminals	2-8
	Terminal arrangement	2-8
	Precautions when wiring	2-8
	Wiring	2-8

2.1 Setup

- On a standard type controller, set up the output units for control outputs 1 and 2 before mounting the controller.
- On a position-proportional type controller, the relay output unit is already mounted. So, this setup operation is unnecessary. (That is, do not replace the currently mounted unit with other output units.)
- When setting up the output units, draw out the internal mechanism from the housing, and insert the output units into the sockets for control outputs 1 and 2.

■ Draw-out

When drawing out the internal mechanism from the housing, prepare a Phillips screwdriver matched to the size of the screw on the lower part of the front panel.

- (1) Press down on the hook on the top of the front panel, and turn the Phillips screwdriver to the left to loosen the screw on the lower part of the front panel.

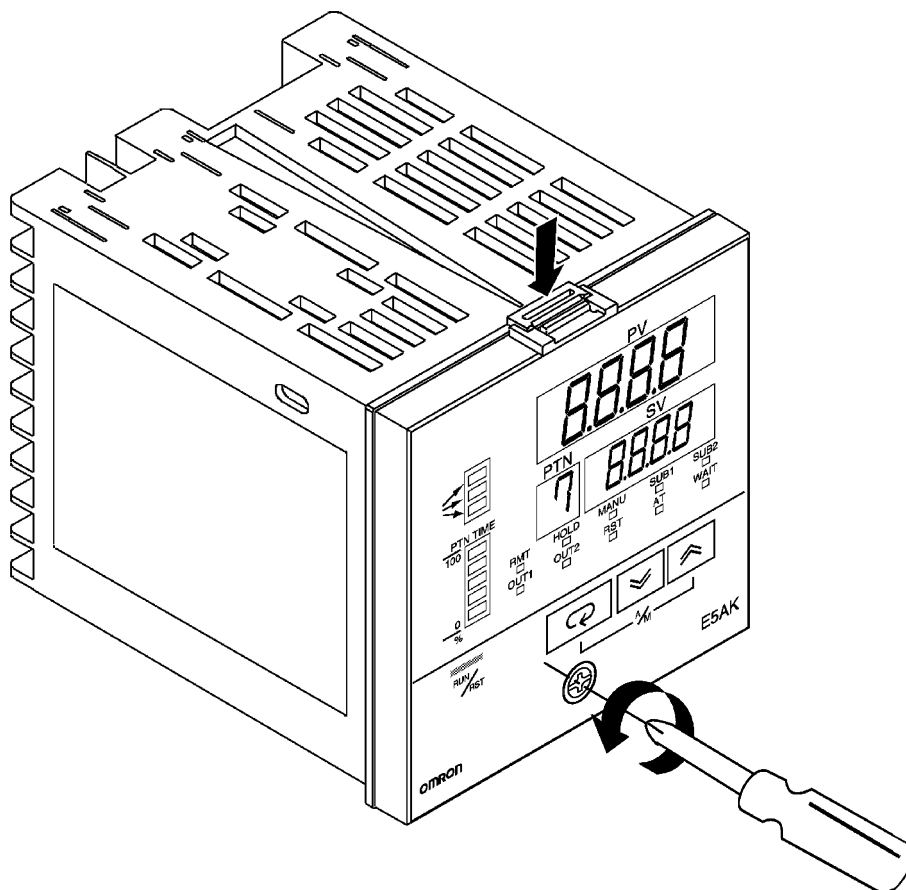

- (2) Draw out the internal mechanism towards you holding both sides of the front panel.



Fixing Screw for Front Panel

Tighten this screw by a torque of 0.3 to 0.5 N·m (approx. 3 to 5 kgf·cm).

■ Setting up the output unit

● Before setup

- Check the type of the output unit you are about to set up.
- For details on types of output unit and main specifications, see page 2-7.

● Procedure

- (1) Check the positions of the sockets you are about to insert the output units into as shown in the following diagram.

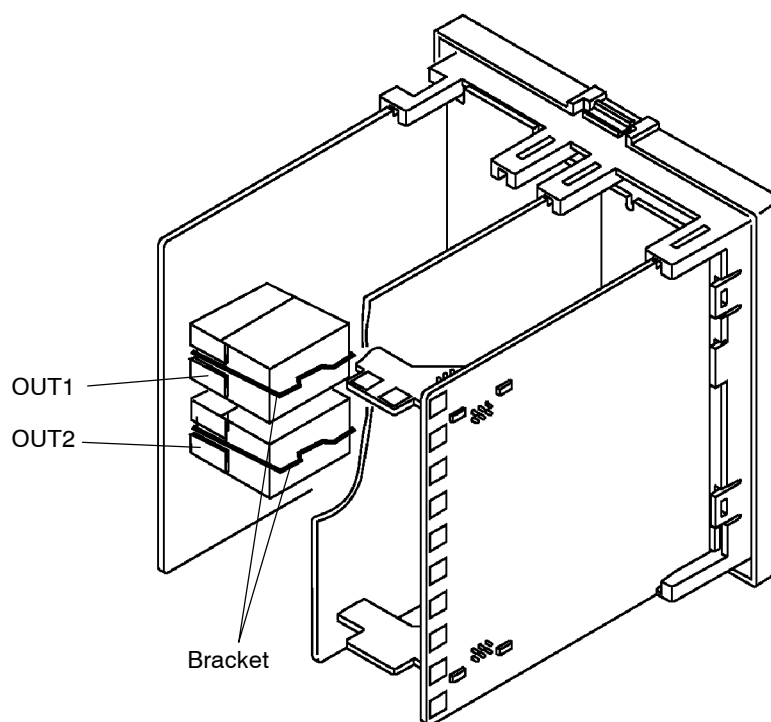

- (2) Insert the output unit for control output 1 into the socket “OUT1” and the output unit for control output 2 into the socket “OUT2”.
- (3) Fasten the output units with the bracket (accessory).

■ Setting up the option unit

● Before setup

- Check the type of the option unit you are about to set up.
- For details on types of option unit and main specifications, see Appendix, Model List (page A-12) and Appendix, Option Unit Ratings and Characteristics (page A-4).
- For details on the relationship between units and terminals, see page 2-8.

● Procedure

- (1) Remove the power board and option boards in the order shown in the following diagram.

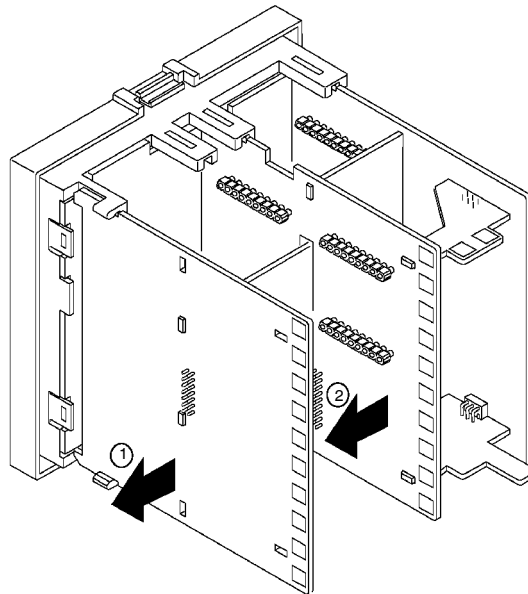

- (2) Insert the option units into the sockets for options 1 to 3. The following diagram shows the relationship between option units and mounting positions.

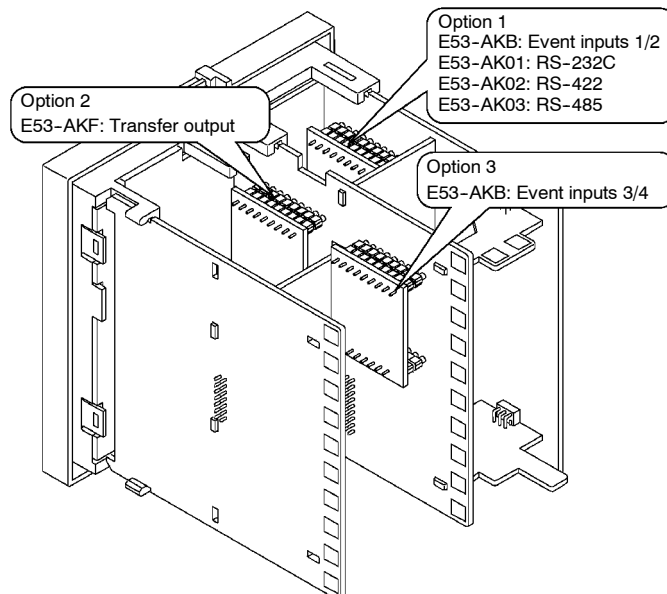

- (3) Mount the option boards and the power board in the order shown.

2.2 Installation

■ Dimensions

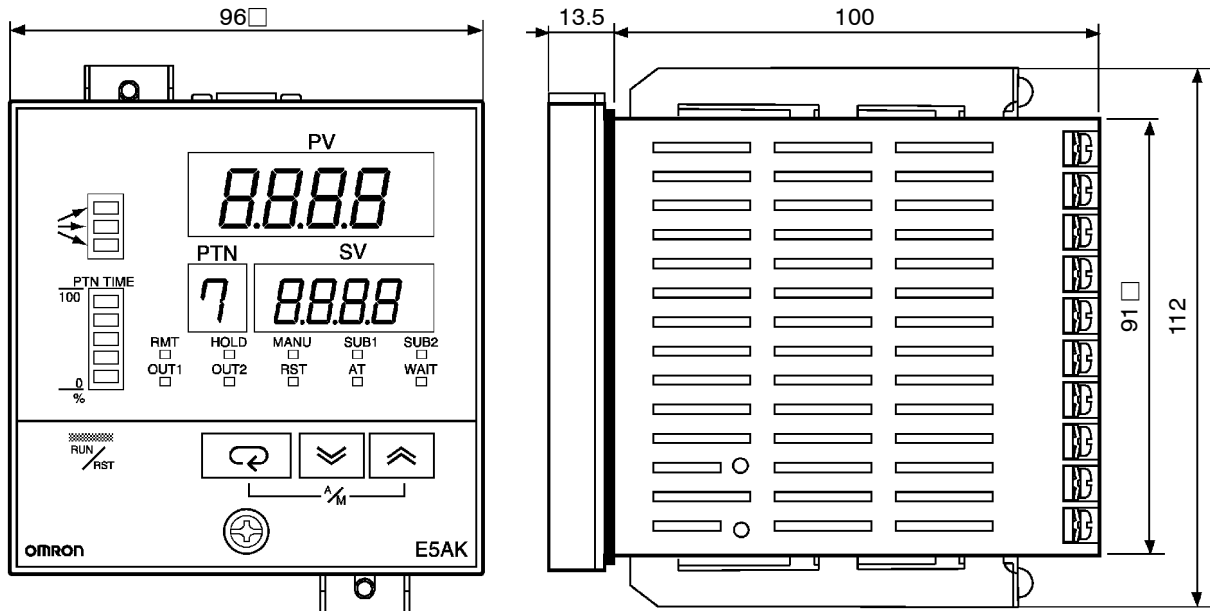

■ Panel cutout

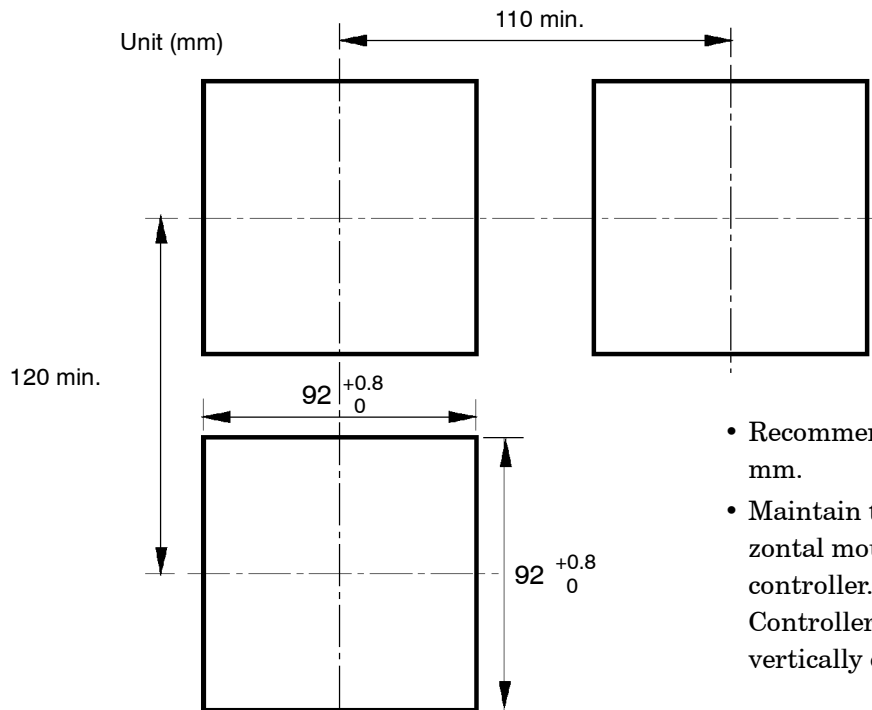

- Recommended panel thickness is 1 to 8 mm.
- Maintain the specified vertical and horizontal mounting space between each controller. Controllers must not be closely mounted vertically or horizontally.

■ Mounting

- (1) Insert the E5AK-T controller into the mounting hole in the panel.
- (2) Fit the mounting bracket (accessory) into the fixing slots on the top and bottom of the rear case.

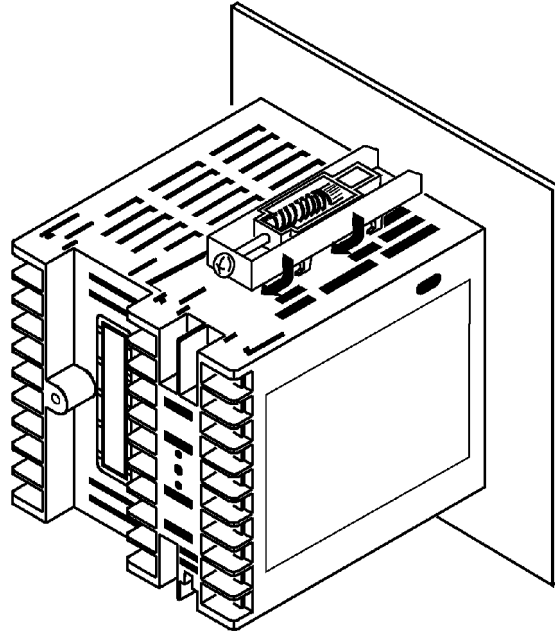

- (3) Tighten the mounting bracket screws alternately a little at a time until the ratchet starts to slide.

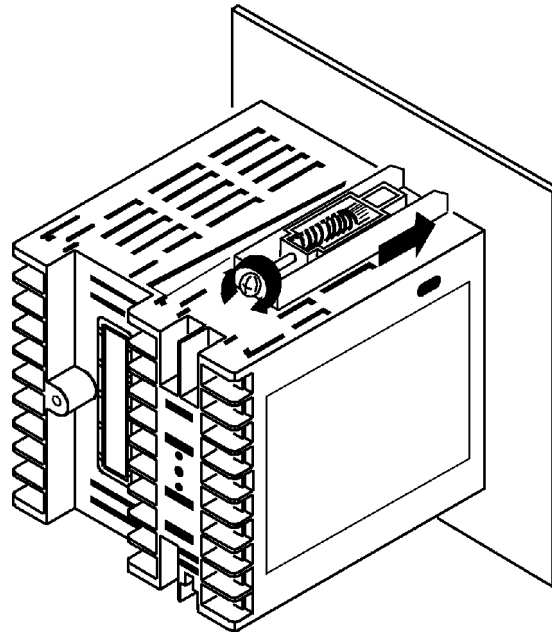

● Setting up the terminal covers

- Fasten the terminal covers (E53-COV0809) to protect terminals.
- E5AK-□□2-500 controller is provided with terminal covers.
- Use E53-COV09 for terminals 1 to 10, and E53-COV08 for terminals 11 to 33.
- Fasten the terminal covers as follows by using the snap pins.

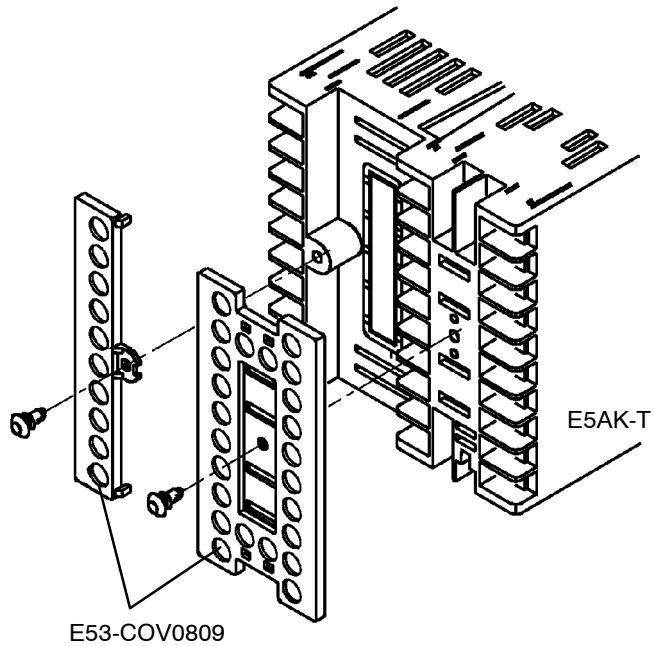

- To remove the terminal covers, pull the edges of the snap pins.

2.3 Wiring Terminals

Terminal arrangement

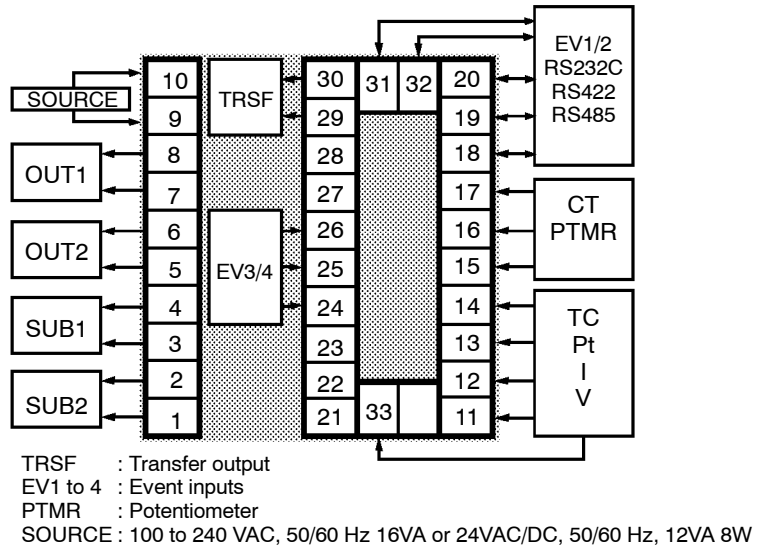

Precautions when wiring

- On some models, terminals are not used and are left free. Do not wire these terminals.
- Separate input leads and power lines in order to protect the controller and its lines from external noise.
- We recommend using solderless terminals when wiring the controller.
- Tighten the terminal screws using a torque no greater than 0.78 N·m (8kgf·cm).
- Use the following type of solderless terminals for M3.5 screws.

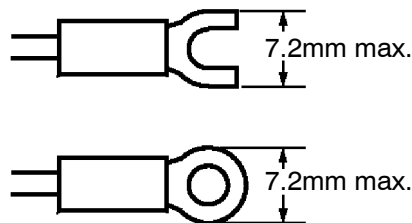

Wiring

Power supply

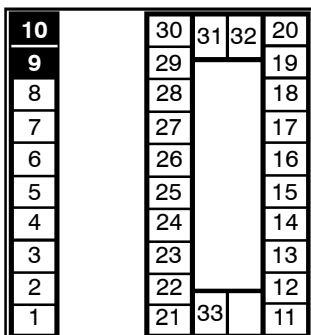

In the following wiring diagrams, the left side of the terminal Nos. indicates the inside of the controller.

- Input power to terminals Nos. 9 and 10. Power specifications are as follows:
 100 to 240 VAC, 50/60 Hz, approx. 16 VA
 or
 24 VAC, 50/60 Hz, approx. 12 VA
 24 VDC, 8W

● **Sensor input**

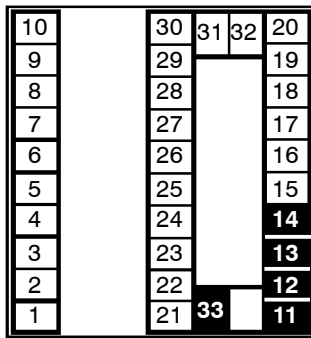

- Connect the sensor input to terminal Nos. 11 to 14 and 33 as follows according to the input type.

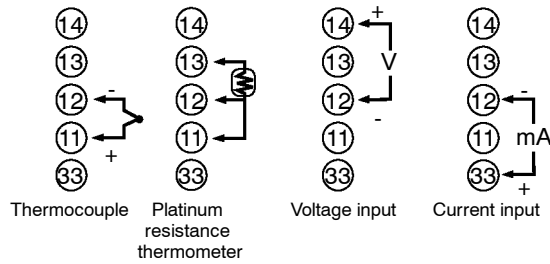

● **Control output**

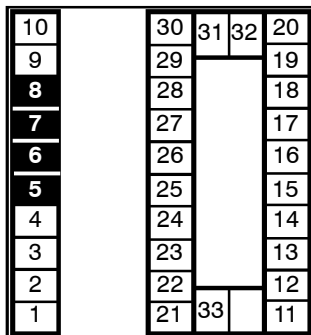

- Terminal Nos. 7 and 8 are for control output 1 (OUT1), and terminal Nos. 5 and 6 are for control output 2 (OUT2). The following diagrams show the available output units and their internal equalizing circuits.

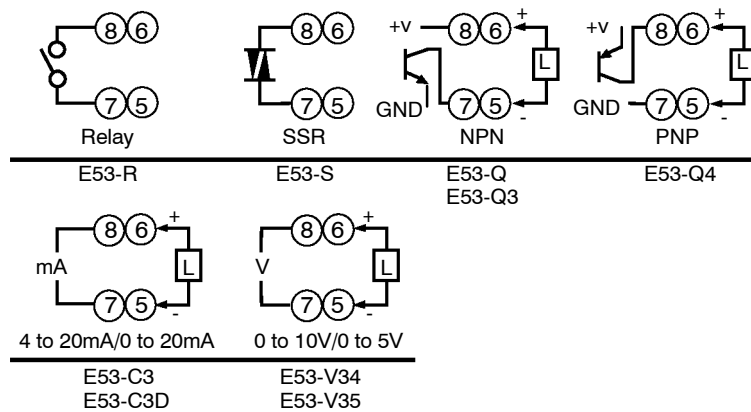

- With E53-V□□ output units, about 2 V is output for one second after the power is interrupted.
- The following table shows the specifications for each output unit.

Model	Output Type	Output Mode	Specifications
E53-R	Relay	Pulse	250 VAC, 5 A
E53-S	SSR	Pulse	75 to 250 VAC, 1 A
E53-Q E53-Q3 E53-Q4	Voltage (NPN) Voltage (NPN) Voltage (PNP)	Pulse Pulse Pulse	NPN : 12 VDC, 40 mA (with short-circuit protection) NPN : 24 VDC, 20 mA (with short-circuit protection) PNP : 24 VDC, 20 mA (with short-circuit protection)
E53-C3 E53-C3D	4 to 20 mA 0 to 20 mA	Linear Linear	4 to 20 mA, Permissible load impedance: 600 Ω max., Resolution: Approx. 2600 0 to 20 mA, Permissible load impedance: 600 Ω max., Resolution: Approx. 2600
E53-V34 E53-V35	0 to 10 V 0 to 5 V	Linear Linear	0 to 10 VDC, Permissible load impedance: 1 kΩ min., Resolution: Approx. 2600 0 to 5 VDC, Permissible load impedance: 1 kΩ min., Resolution: Approx. 2600

- With E5AK-TPRR2 controllers, relay output (250 VAC, 1A) is fixed. When the output unit is replaced, use the E53-R. The following diagrams show the relationship between terminals and open/close relay terminal settings.

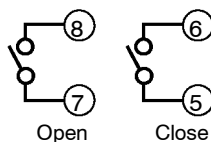

● **Auxiliary output**

10		30	31	32	20
9		29			19
8		28			18
7		27			17
6		26			16
5		25			15
4		24			14
3		23			13
2		22			12
1		21	33		11

- Terminal Nos.3 and 4 are for auxiliary output 1 (SUB1) and terminal Nos.1 and 2 are for auxiliary output 2 (SUB2).
- The internal equalizing circuits for the auxiliary outputs are as follows:

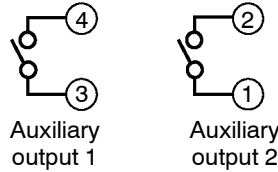

- Output specifications are as follows:
SPST-NO, 250 VAC, 3 A

● **CT input/
Potentiometer**

10		30	31	32	20
9		29			19
8		28			18
7		27			17
6		26			16
5		25			15
4		24			14
3		23			13
2		22			12
1		21	33		11

- When the HBA function on an E5AK-TAA2 controller is used, connect CT input (CT) to terminal Nos.15 and 17. When monitoring the valve opening on an E5AK-TPRR2 controller, connect the potentiometer (PTMR) to terminal Nos.15 to 17. Connect each of these inputs as follows:



- For details on CT inputs, see Appendix, About Current Transformer (CT) Input (page A-5).
- For details on the potentiometer, see the Instruction Manual for the valve connected to the controller.

The meaning of terminal symbols is as follows:

O: OPEN, W: WIPE, C: CLOSE

The variable resistance range is 100 Ω to 2.5 kΩ



About Isolation

The E5AK-T has independent power supplies for each of the terminal blocks shown on the right.

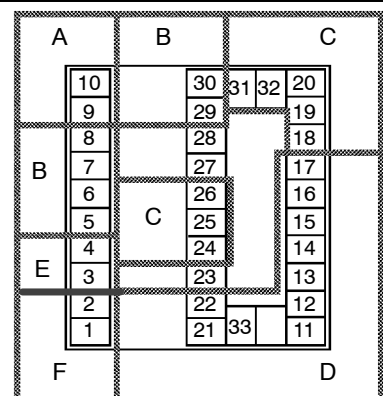

● Event input

10		30	31	32	20
9		29			19
8		28			18
7		27			17
6		26			16
5		25			15
4		24			14
3		23			13
2		22			12
1		21	33		11

- Connect event inputs 1 and 2 (EV1/2) to terminal Nos.18 to 20, and event events 3 and 4 (EV3/4) to terminal Nos.24 to 26. However, note that terminal Nos.18 to 20 cannot be used on controllers supporting the communications function.
- Connect the event inputs as follows:

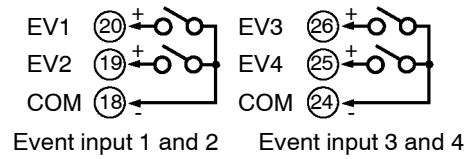

Terminal Nos.18 and 24 (COM) are connected internally.

- Use event inputs under the following conditions:

Contact input	ON: 1 kΩ max., OFF: 100 kΩ min.
No-contact input	ON: residual voltage 1.5 V max., OFF: leakage current 0.1 mA max.

- Polarities during no-contact input are as follows:

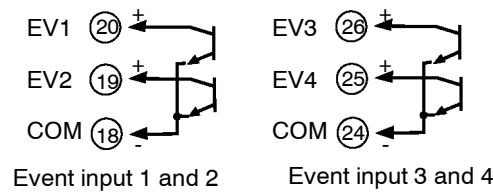

● Transfer output

- Connect transfer output (TRSF) to terminal Nos. 29 and 30.
- The internal equalizing circuit for transfer output is as follows:

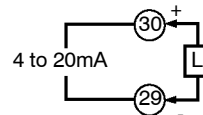

- Transfer output specifications are as follows:
4 to 20 mA DC, Permissible load impedance: 600 Ω max., Resolution: Approx. 2600

● Communications

- Terminal Nos.18 to 20, 31 and 32 can be used only on controllers that support the communications units (E53-AK01/02/03).
- For details on wiring, see Chapter 6, Using the Communications Function.

K CHAPTER 3

BASIC OPERATION

This chapter describes actual examples for understanding the basic operation of the E5AK-T.

3.1	Convention Used in this Chapter	3-2
3.2	Setting Input Specifications	3-4
	Input type	3-4
	Temperature input	3-5
	Analog input	3-5
3.3	Setting Output Specifications	3-7
	Output assignments	3-7
	Direct/reverse operation	3-8
	Control period	3-8
3.4	Setting Alarm Type	3-10
	Alarm type	3-10
	Alarm value	3-10
	Alarm hysteresis	3-11
	Close in alarm/open in alarm	3-11
3.5	Setting Patterns	3-14
	Pattern No.	3-15
	Number of steps	3-15
	Step SP/Step time	3-15
	Alarm value	3-16
3.6	Protect Mode	3-19
	Security	3-19
	Key protect	3-19
3.7	Starting and Stopping Operation	3-21
3.8	Adjusting Control Operation	3-22
	Changing currently running programs ...	3-22
	Manual operation	3-24
	Auto-tuning (A.T.)	3-25

3.1 Convention Used in this Chapter

This chapter describes basic E5AK-T operations such as how to set up parameters, start and stop operation, and adjust control operation. For more complex control examples, refer to Chapter 4 Applied Operation and Chapter 5 Parameters.

● Basic Operation Flow

The following diagram shows the basic flow of operation.

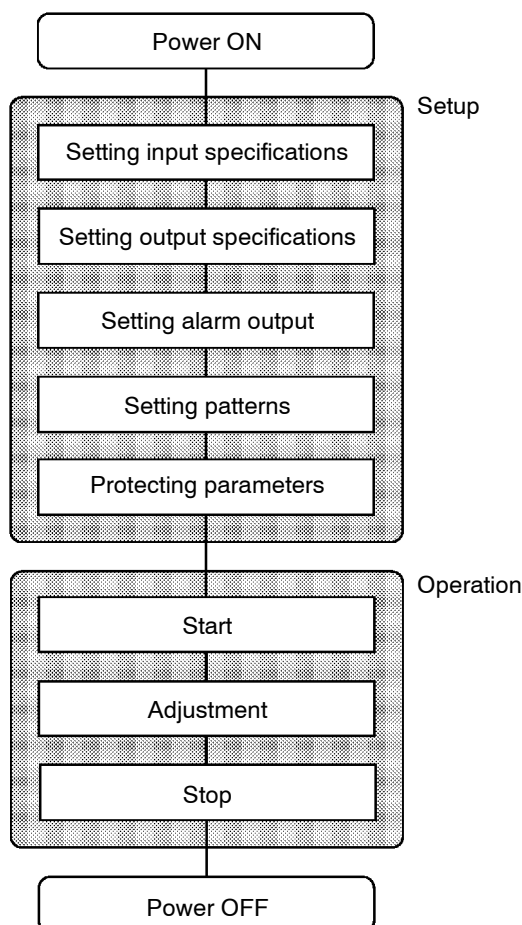

The descriptions in this chapter follow the order of basic operations shown in the flow above. Examples of operation of each of the items are described up to completion of parameter setup. However, you must move to the top parameter of the following setting. For example, when you have finished “setting input specifications” and you want to “set output specifications,” move to the top parameter of “setting output specifications” from the bottom parameter of “setting input specifications.”

For details on moving to parameters between items, refer Chapter, Selecting modes and Selecting parameters (page 1-10).

● Setup examples

This description assumes that the controller is operated under the following conditions.

- A K thermocouple is used as the input.
- Control output (heat), alarm 1 and alarm 2 functions are assigned to “control output 1,” “control output 2” and auxiliary output 1, respectively. Of these, only control output 1 and auxiliary output 1 are used.
- The relay output unit is mounted at control output 1.
- The upper-limit alarm is set as alarm 2. The alarm is output when the temperature exceeds 10°C with respect to the PV.
- The program is made up of one pattern comprising four steps.
- The following figures show terminal wiring and the program used in the setting examples.

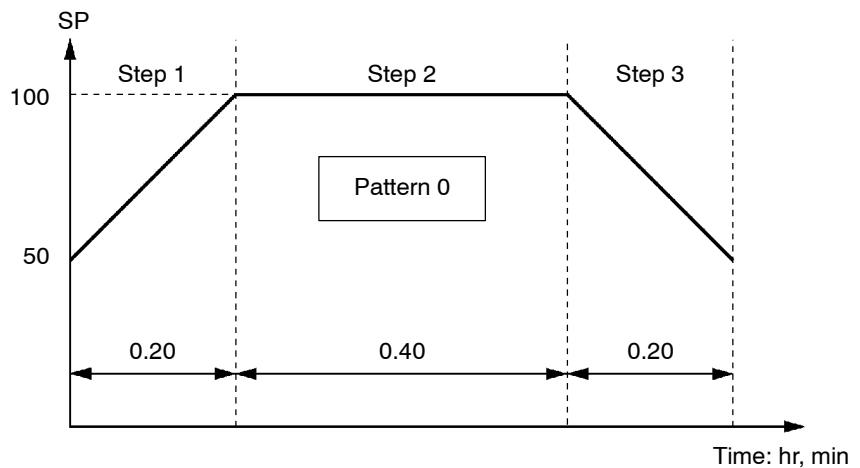
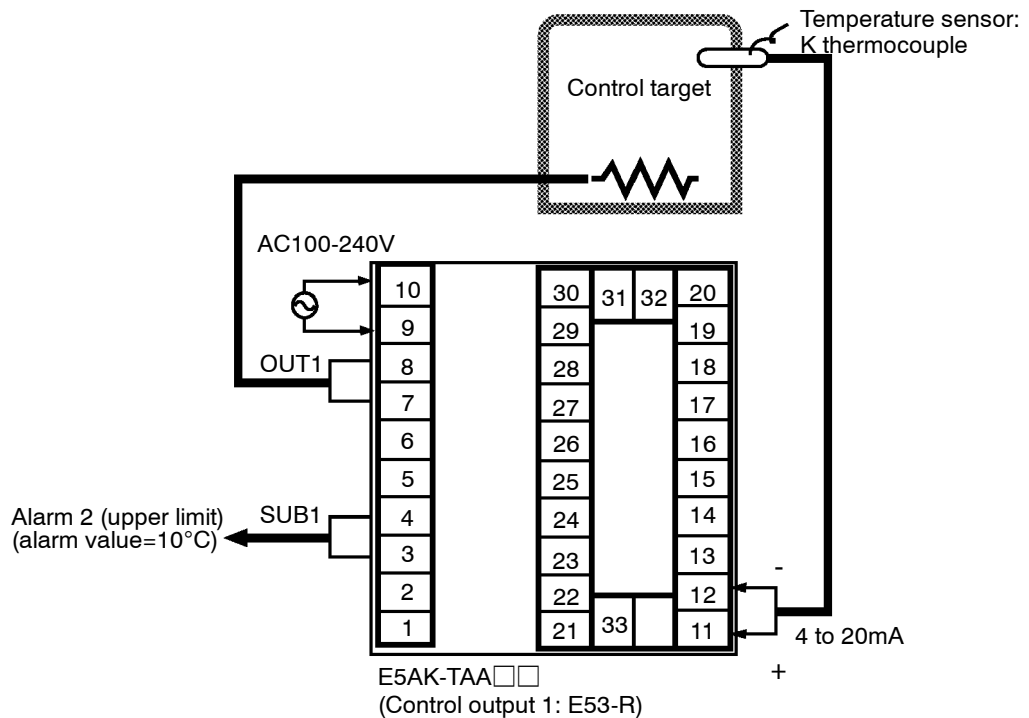

3.2 Setting Input Specifications

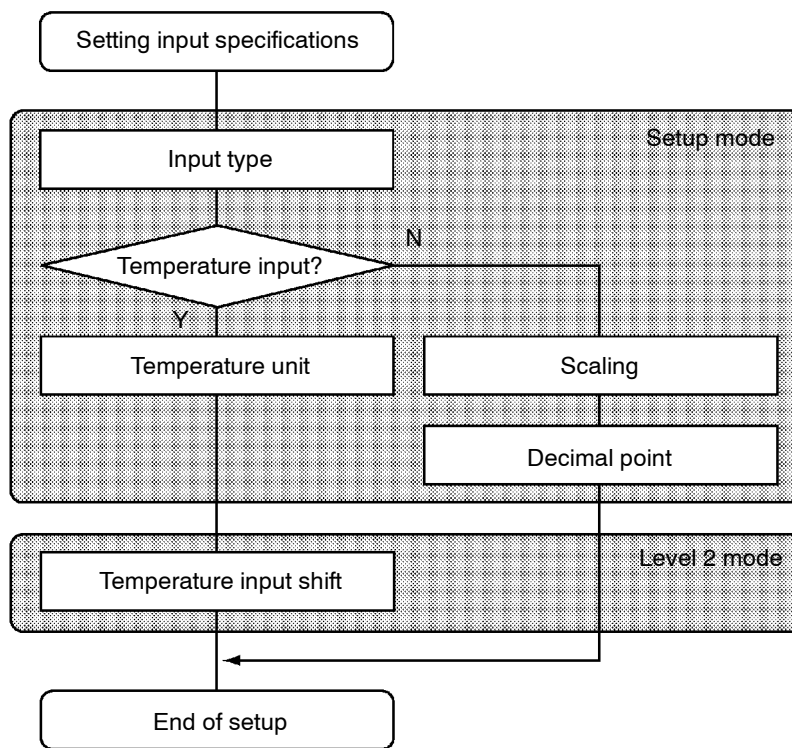

- With temperature input, scaling and decimal point parameters need not be set as this information is determined by the input (sensor) type. (These parameters are not displayed.) Note that temperature unit and temperature input shift parameters need to be set.
- With analog input, the “scaling upper limit”, “scaling lower limit” and “decimal point” parameters need to be set.

■ Input type

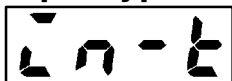

- Set the type No. (0 to 21) in the “input type” parameter (Set up mode). The factory setting is “2: K1 (thermocouple).”
- For details on input types and setting ranges, see page 5-31.

Temperature input

● Temperature unit

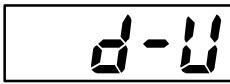

- To switch the temperature unit from “°C” to “°F” when input is temperature, switch the “°C/°F selection” parameter (setup mode) from “C” to “F”.

● Temperature input shift



- When input is temperature input, the upper and lower limit values of the sensor can be shifted linearly. For example, if both the upper and lower limit values are shifted by 1.2°C, the process value (before shift) is regarded as 201.2°C after shift when input is 200°C before shift.
- To set input shift, set shift values in the “input shift upper limit” and “input shift lower limit” parameters (level 2 mode).

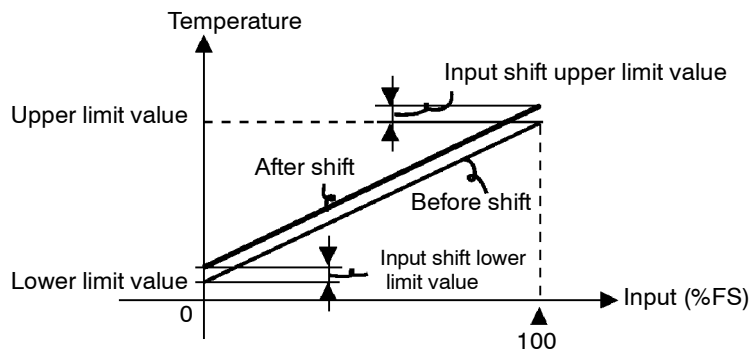

Analog input



- When the analog input (the voltage input and current input) is selected, scaling matched to the control is required.
- The “scaling upper limit”, “scaling lower limit” and “decimal point” parameters (setup mode) are used for scaling. These parameters cannot be used when the temperature input type is selected.
- The “scaling upper limit” parameter sets the physical quantity to be expressed by the upper limit value of input, and the “scaling lower limit” parameter sets the physical quantity to be expressed by the lower limit value of input. The “decimal point” parameter sets the number of digits past the decimal point.
- The following figure shows a scaling example of 4 to 20 mA input. After scaling, the humidity can be directly read. In this case, the “decimal point” parameter is set to “1”.

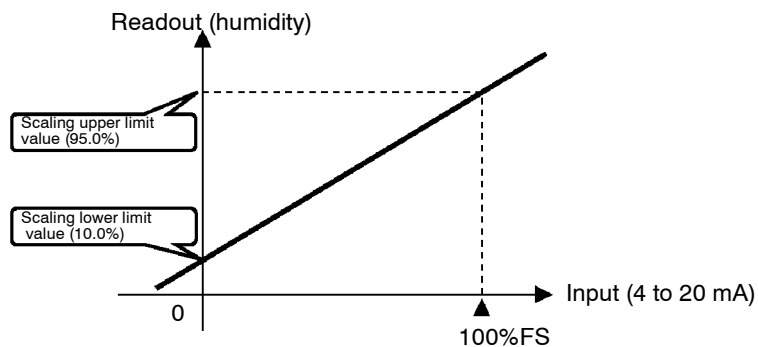

Setting Example

In this example, let's check the input type and temperature units, and shift the lower limit by 1°C and the upper limit by 3°C.

- “input type” = “2: K1”
- “temperature unit” = “°C”
- “input shift upper limit” = “3.0”
- “input shift lower limit” = “1.0”

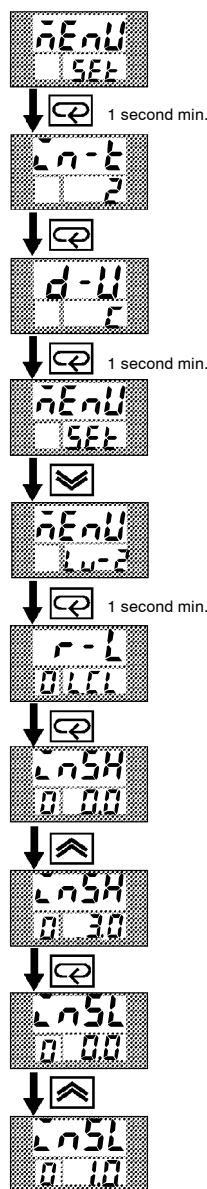

- (1) Select the menu display, and select “SET: setup mode” using the or keys. For details on selecting the menu display, see page 1-10.
- (2) Press the key for one second minimum to enter the setup mode. The top parameter in the setup mode “I-T: input type” is displayed. This parameter is factory-set to “2: K1”.
- (3) Press the key to fix the set value. The display changes to “d-U: °C/°F selection” parameter. This parameter is factory-set to “C: °C”.
- (4) Select the menu display, and select “L2: level 2 mode” using the or keys.
- (5) Press the key for one second minimum to enter the level 2 mode. The top parameter in the level 2 mode [I-SH] (“local/remote” parameter) is displayed.
- (6) Press the key until [I-SH] (“input shift upper limit” parameter) is selected. This parameter is factory-set to “0.0”.
- (7) Press the key until “3.0” is displayed.
- (8) Press the key until [I-SH] (“input shift lower limit” parameter) is selected. This parameter is factory-set to “0.0”.
- (9) Press the key until “1.0” is displayed. This sets the “input shift upper limit” and “input shift lower limit” values.

3.3 Setting Output Specifications

Some output specifications are different according to controller type, standard or position-proportional. The following table summarizes which output-related parameter settings are supported.

Parameter		Standard Type	Position-proportional Type
OUT1	Control output 1 assignment	●	
OUT2	Control output 2 assignment	●	
SUB1	Auxiliary output 1 assignment	●	●
SUB2	Auxiliary output 2 assignment	●	●
ORV	Direct/reverse operation	●	●
CP	Control period (heat)	●	
C-CP	Control period (cool)	●	

(● Indicates that an output specification is supported.)

Output assignments

● Standard type

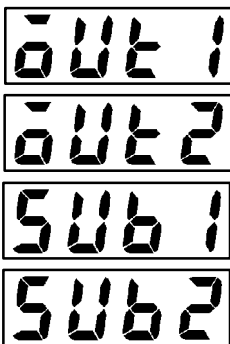

Output assignments are described according to controller type.

- Thirteen outputs are supported. These functions are assigned to control outputs 1 and 2, and auxiliary outputs 1 and 2.
- Restrictions on assignment destination are placed on some of the outputs.
- The following table shows where outputs may be assigned to.

Assignment Destination / Output Function	Control Output		Auxiliary Output	
	1	2	1	2
Control output (heat)	●	●		
Control output (cool)	●	●		
Alarm 1	●	●	●	●
Alarm 2	●	●	●	●
Alarm 3	●	●	●	●
HBA	●	●	●	●
LBA	●	●	●	●
Time signal 1	●	●	●	●
Time signal 2	●	●	●	●
Program end	●	●	●	●
Stage output	●	●	●	●
Error 1 : Input error			●	●
Error 2 : A/D convertor error			●	●

With control output (cool), the conditions for switching from standard control to heating and cooling control are reached when the output function is assigned at the cooling side during heating and cooling control.

In other words, heating and cooling control is carried out when control output (cool) is assigned, and standard control is carried out when output is not assigned. For details on heating and cooling control, see Chapter 4 Applied Operation/4.1 Selecting the Control Method (page 4-2).

- Factory settings are as follows:
 - control output 1 = Control output (heat)
 - control output 2 = Alarm 1
 - auxiliary output 1 = Alarm 2
 - auxiliary output 2 = Alarm 3
- Output assignments are set in the “control output 1 assignment”, “control output 2 assignment”, “auxiliary output 1 assignment” and “auxiliary output 2 assignment” parameters (setup mode).

● Position-proportional type

Sub 1

Sub 2

- Position-proportional type controllers support nine output functions. These are assigned to auxiliary outputs 1 and 2.
- Restrictions on assignment destinations are placed on some of the outputs. The following table shows where outputs may be assigned to.

Assignment Destination \ Output Function	Control Output		Auxiliary Output	
	1	2	1	2
Alarm 1			●	●
Alarm 2			●	●
Alarm 3			●	●
Time signal 1			●	●
Time signal 2			●	●
Stage output			●	●
Program end output			●	●
Error 1 : Input error			●	●
Error 2 : A/D converter error			●	●

■ Direct/reverse operation

drEv

- “Direct operation” (or normal operation) refers to control where the manipulated variable is increased according to the increase in the process value. Alternatively, “reverse operation” refers to control where the manipulated variable is decreased according to the decrease in the process value.

For example, when the process value (PV) (temperature), is lower than the set point (SP) (temperature), in a heating control system, the manipulated variable increases by the difference between the PV and SP values.

Accordingly, this becomes “reverse operation” in a heating control system, or alternatively, “direct operation” in a cooling control system.

- Direct/reverse operation is set in the “direct/reverse operation” parameter (setup mode). Default is “drEv : reverse operation”.

■ Control period

CP

C-CP

- On position-proportional type controllers, this item cannot be set.
- On a standard type controller, when the output unit is for pulse output such as relay output, set the pulse output cycle (control period). Though a shorter control period provides better control performance, the control period should be set to 20 seconds minimum taking the life expectancy of the output unit into consideration when the output unit is for relay output.
- The control period is set in the “control period (heat)” parameter (level 1 mode). Default of the “control period” parameter is factory-set to “20:20 seconds.” The “control period (cool)” output function is not assigned. So, the “control period (cool)” parameter cannot be set.

Setting Example

All of the above settings in this example are factory settings. In this example, let's check the parameter settings.

In this example, the parameters are set as follows:

- “control output 1 assignment” = “control output (heat)”
- “auxiliary output 1 assignment” = “alarm output 2”
- “direct/reverse operation” = “reverse operation”
- “control period” = “20 secs”

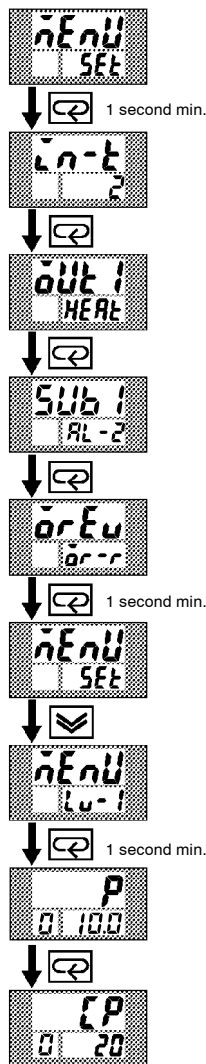

- (1) Select the menu display, and select “SEt: setup mode” using the or keys. For details on selecting the menu display, see page 1-10.
- (2) Press the key for one second minimum to enter the setup mode. The top parameter in the setup mode “Ln-t : input type” is displayed.
- (3) Press the key until [out 1] (“control output 1 assignment” parameter) is displayed. Default is [HEAt].
- (4) As the setting in this example is to be left as it is, press the key twice. The display changes to [Sub 1] (“auxiliary output 1 assignment” parameter). Default is [AL-2].
- (5) As the setting in this example is to be left as it is, press the key until [orEu] (“direct/reverse operation” parameter) is displayed. Default is [or-r].
- (6) As the setting in this example is to be left as it is, press the or keys to select “Lv-1 : level 1 mode”. For details on selecting the menu display, see page 1-7.
- (7) Press the key for one second minimum to enter the level 1 mode. The top parameter in the level 1 mode “P : Proportional band” is displayed.
- (8) Press the key until [CP] (“control period (heat)” parameter) is displayed. Default is “20”. As the setting in this example is to be left as its is, quit key operation.

3.4 Setting Alarm Type

- Three alarm outputs are supported: alarms 1 to 3. Of these, only the alarm assigned as the output can be used.
- Alarm output conditions are determined according to the combination of the “alarm type”, “alarm value” and “alarm hysteresis” parameter settings.
- The contact conditions for when alarm output is ON can be set to “open” or “closed” in the “close in alarm/open in alarm” parameter.
- The following table shows the alarm types supported by the E5AK-T controller and their respective operations.

■ Alarm type

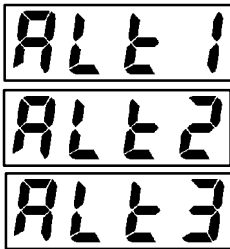

Alarm Type	Alarm Output Operation	
	When X is positive	When X is negative
1 Upper-and lower-limit alarm (deviation)	ON OFF	Always ON
2 Upper-limit alarm (deviation)	ON OFF	ON OFF
3 Lower-limit alarm (deviation)	ON OFF	ON OFF
4 Upper-and-lower-limit range alarm (deviation)	ON OFF	Always OFF
5 Upper-and-lower-limit alarm with standby sequence (deviation)	ON OFF	Always OFF
6 Upper-limit alarm with standby sequence (deviation)	ON OFF	ON OFF
7 Lower-limit alarm with standby sequence	ON OFF	ON OFF
8 Absolute-value upper-limit alarm	ON OFF	ON OFF
9 Absolute-value lower-limit alarm	ON OFF	ON OFF
10 Absolute-value upper-limit alarm with standby sequence	ON OFF	ON OFF
11 Absolute-value lower-limit alarm with standby sequence	ON OFF	ON OFF

- Alarm types are set independently for each alarm in the “alarm 1 to 3” parameters (setup mode). Default is “2: Upper-limit alarm (deviation)”.

■ Alarm value

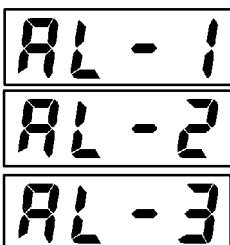

- Alarm values are indicated by “X” in the table above. Alarm output operation differs according to whether the value of the alarm is positive or negative.
- Alarm values are built into the program and are set for each pattern. For details, see “3.5 Setting Patterns” (page 3-14).

Alarm hysteresis

ALH1
ALH2
ALH3

- The hysteresis of alarm outputs when alarms are switched ON/OFF can be set as follows:

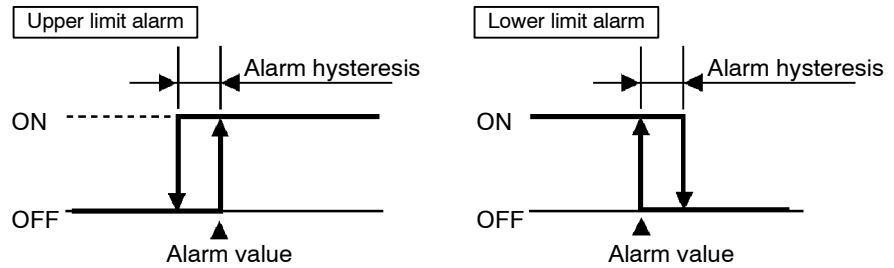

- Alarm hysteresis is set independently for each alarm in the “alarm 1 to 3 hysteresis” parameters (level 2 mode). Default is “0.02: 0.02%FS”.

Standby sequence

- “Standby sequence” is a function for unconditionally turning alarm output OFF when the process value has left the alarm range once and it next enters the alarm range.
- For example, when the alarm type is set to “lower-limit alarm,” generally the process value is within the alarm range, and alarm output smaller than the set point, and alarm output becomes ON when this state continues. However, if the alarm type is set to “lower-limit alarm with standby sequence”, alarm output first becomes ON when the process value exceeds the alarm setting value to leave the alarm range and once again falls below the alarm value.
- The standby sequence is canceled when an alarm is output. It is, however, restarted later by one of the following conditions:
 - Operation is started or power is turned ON.
 - A pattern is started.
 - The program advances to the next step.
 - The SP of the current step is changed.
 - The currently running alarm value is changed.
 - The input shift value is changed.
 - Advance is executed.

Close in alarm/open in alarm

AL1a
AL2a
AL3a

- When the controller is set to “close in alarm,” the status of the alarm output function is output as it is. When set to “open in alarm,” the status of the alarm output function is output inverted.

	Alarm	Output	Output LED
Close in alarm	ON	ON	Lit
	OFF	OFF	Not lit
Open in alarm	ON	OFF	Lit
	OFF	ON	Not lit

- Alarm type and close in alarm (normally open)/open in alarm (normally close) can be set independently for each alarm.
- Close in alarm/open in alarm is set in the “alarm 1 to 3 open in alarm” parameters (setup mode). Default is “ $n - \bar{a}$: close in alarm”.

● **Summary of alarm operations**

The figure below visually summarizes the above descriptions of alarm operations (when alarm type is set to “lower-limit alarm with standby sequence”):

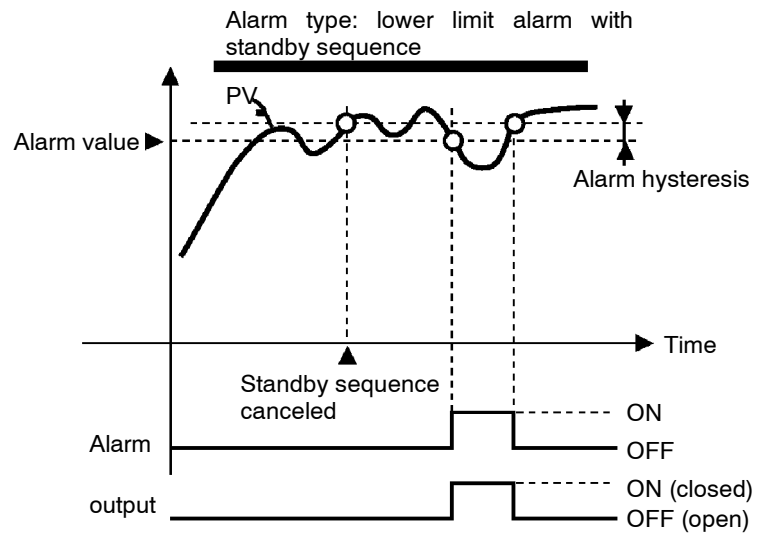

Setting Example

Alarm 2 is output when the temperature exceeds alarm value 2 programmed to the SP. Parameter factory settings for “alarm type 2,” “alarm hysteresis” and “close in alarm/open in alarm” are used.

In this example, the related parameters are set as follows:

“alarm type 2” = “2: upper-limit”





“alarm value 2” = (set in program setting)

“alarm hysteresis: = “0.02”

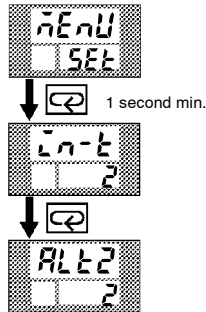
“close in alarm/open in alarm” = “ \bar{c} : close in alarm”

In this example, let’s check the alarm type.



- (1) Select the menu display, and select “**SET** : setup mode” pressing the  or  keys. For details on selecting the menu display, see page 1-9.
- (2) Press the  key to enter the setup mode. The top parameter in the setup mode “**Cn-t** : input type” is displayed.
- (3) Press the  key until [**ALt2**] (“alarm type 2” parameter) is displayed. Default is “2: upper limit”.

3.5 Setting Patterns

If you want to set parameters in the program mode during controller operation, you must first stop operation. Operation may continue only in special instances, for example, to change SP during controller operation.

- Parameters that you use frequently for programming can be set in the “program mode.” The flow below shows the parameters that are available in the program mode and the order in which they are set.

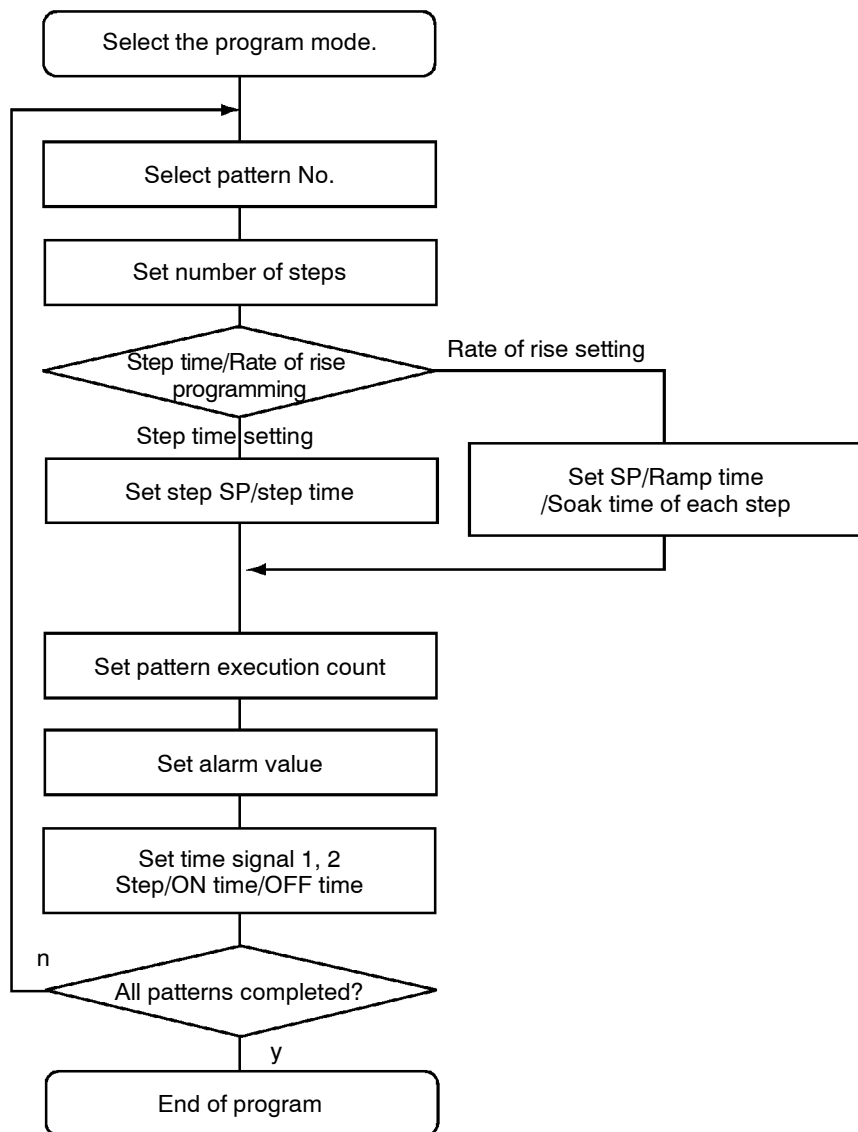

This chapter describes the basic operation of programming. For details on the following parameters, refer to Chapter 4 Applied Operation: “Step time/Rate of rise programming”, “Pattern execution count”, “Time signal 1, 2”

Pattern No.

Plrn

- This parameter cannot be changed during controller operation.
- Set the desired pattern No. Step SP, step time, alarms and other parameters that follow this parameter are set for the pattern that is set in this parameter.
- Set within the range 0 to 7 (pattern 0 to 7). Default is “0”.

Number of steps

5-nā

- Set the number of steps for the pattern that you specified in the “pattern No.” parameter.
- Set within the range 1 to 16 (step). Default is “8”.

Step SP/Step time

SP *

EL *

* : 0 to 15

- Set only the number of steps used in the program in order from step 0, as “step 0 SP”, “step 0 time”, “step 1 SP”, “step 1 time” and so forth.
- Set within the range from set point lower limit to set point upper limit for step SP. Default is “0”.
- Set within the range 0.00 to 99.59 (hours:minutes or minutes:seconds). Default is “0.00”.

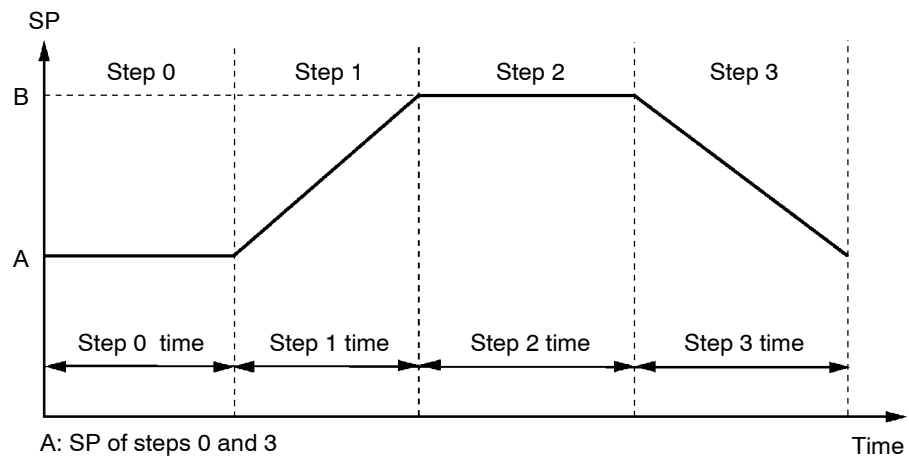

- As shown in the above figure, step 0 is a fixed value, so when ramp operation is started, set the “step 0 time” parameter to “0.00” to configure the program so that ramp operation starts from step 1.

■ Alarm value

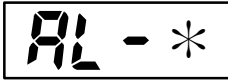

* : 0 to 3

- Alarm values can be set only for alarms that have been assigned as output.
- When a deviation alarm is assigned as output, the alarm value is set with respect to SP. The following example shows the relationship between the SP and alarm value when the alarm type is set to “upper limit.”

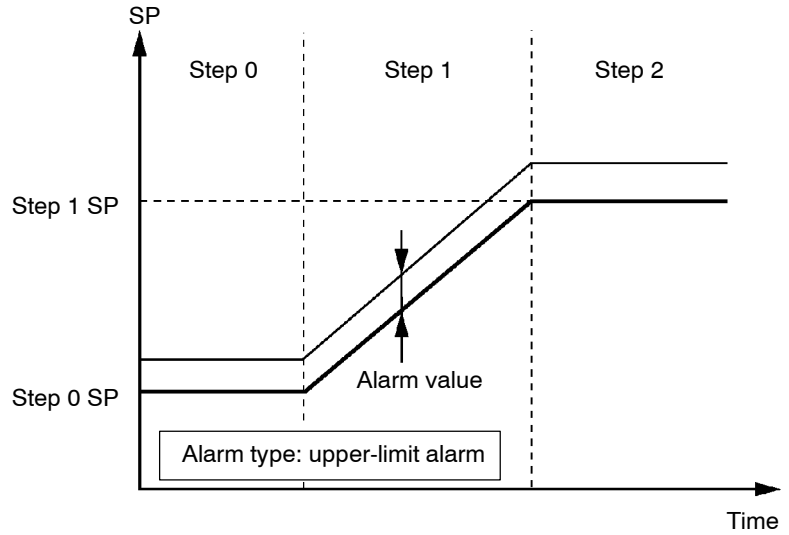

About the Alarm Value Point Decimal

The decimal point of the alarm value conforms to the setting of the “decimal point” parameter.

Setting Example

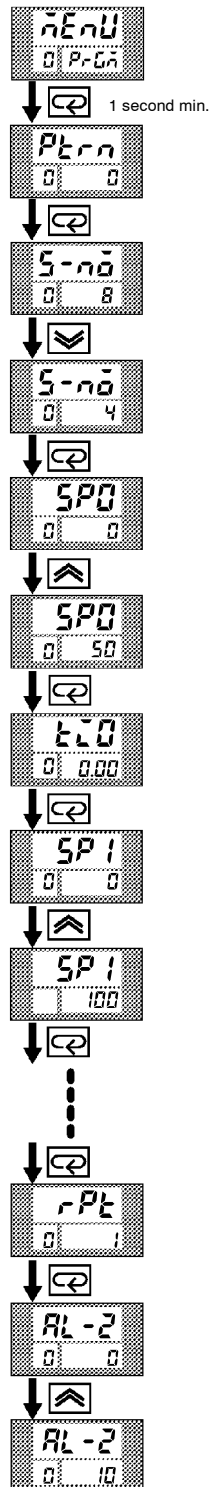

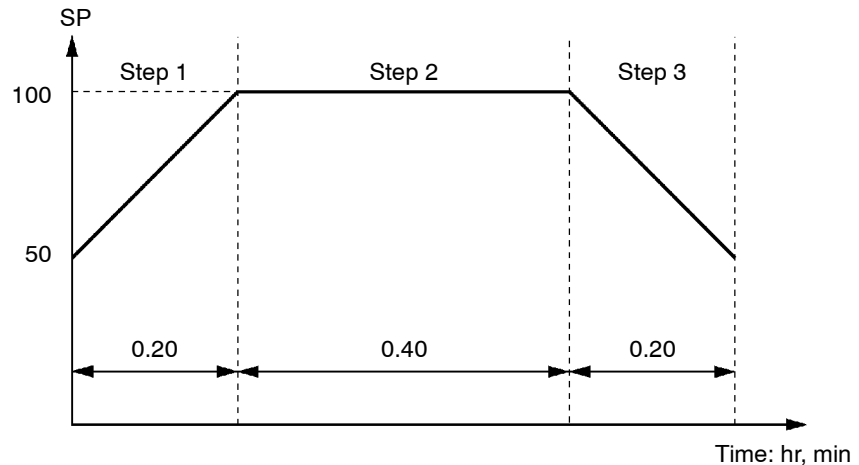

In this example, let's set the next program to pattern 0.



	SP	Time (hr, min.)	Alarm value 2
Step 0	50	0.00	10
Step 1	100	0.20	10
Step 2	100	0.40	10
Step 3	50	0.20	10

- Pattern execution count "1"
- Time signals are not used.

- (1) Select the menu display, and select "Pr-Gr : program" pressing the \uparrow or \downarrow keys. For details on selecting the menu display, see page 1-10.
- (2) Press the \square key to enter the program mode. The top parameter in the program mode "Pattern : pattern" is displayed. Default is "0 : pattern 0".
- (3) As the setting "0: pattern 0" in this example is to be left as it is, press the \square key. The display changes to the [S-nb] ("number of steps" parameter). Default is "8".
- (4) Set the parameter to "4" pressing the \uparrow or \downarrow keys.
- (5) When you press the \square , the display changes to the [SP0] ("step 0 SP" parameter). Default is "0".
- (6) Set the parameter to "50" pressing the \uparrow or \downarrow keys.
- (7) When you press the \square , the display changes to the [tL0] ("step 0 time" parameter). Default is "0.00".
- (8) As the setting "0.00: 0 minutes" in this example is to be left as it is, press the \square key. The display changes to the [SP1] ("step 1 SP" parameter). Default is "0".
- (9) Set the parameter to "100" pressing the \uparrow or \downarrow keys.
- (10) In the same way, set the "tL1 : step 1 time", "SP2 : step 2 SP", "tL2 : step 2 time", "SP3 : step 3 SP", "tL3 : step 3 time" parameters, in that order.
- (11) When you have finished setting the step SPs and times press the \square key. The [r-Pr] ("pattern execution count" parameter, is displayed. Default is "1".)

- (12) As the setting in this example is to be left as it is, set the alarm value. Press the  key until [AL-2] (“alarm 2” parameter) is displayed. Default is “0”.
- (13) Set the parameter to “10: 10 seconds” pressing the  or  keys.

3.6 Protect Mode

■ Security



- This parameter allows you to protect until start of operation parameters that do not change during operation to prevent unwanted modification.
- The set value of the “security” parameter (protect mode) limits the range of protectable parameters. The following table shows the relationship between set values and the range of protection. (Only modes marked by ● can be operated.)

Mode	Set value						
	0	1	2	3	4	5	6
Calibration	●	●					
Option	●	●					
Expansion	●	●					
Setup	●	●					
Level 2	●	●	●				
Level 1	●	●	●	●			
Program	●	●	●	●	●		
Level 0	●	●	●	●	●	●	*1

*1 Only the “PV/Present SP” parameter can be displayed.

- When this parameter is set to “0”, parameters are not protected.
- When this parameter is set to “5”, operations in only the level 0 mode can be selected, and the mode is not displayed on the menu display.
- When this parameter is set to “6”, the “PV/Present SP” parameter can only be monitored.
- Default is “1”.

■ Key protect



- This parameter disables key operation for switching run/reset or auto/manual. For example, if you protect the key operation for switching auto/manual by the “key protect” parameter (protect mode) during automatic operation, the controller cannot be set to the manual mode, preventing manual operation of the controller during operation.
- The following table shows the relationship between set values and keys that are protected.

Set value	Description
0	Key protection OFF
1	A/M cannot be selected.
2	RUN/RST cannot be selected.
3	Both A/M and RUN/RST cannot be selected.

- Default is “0 : All keys can be operated.”

Setting Example

In this example, let's set the parameters as follows:
 "Security" "2" (all parameters in modes other than the setup mode are protected)
 "Key protect" "1" (Auto/manual key operation cannot be switched)

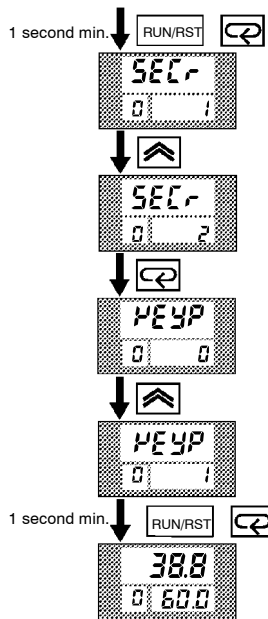

- (1) Press the **RUN/RST** and **[Square Key]** keys simultaneously for 1 second minimum. The controller enters the protect mode. In the protect mode, the top parameter in the protect mode "security" is displayed. Default is "1".
- (2) Press the **[Up Arrow]** key to change the parameter setting to "2".
- (3) Press the **[Square Key]** key to switch to the "key protect" parameter.
- (4) Press the **[Up Arrow]** key to change the parameter setting to "1".
- (5) Press the **[Square Key]** and **RUN/RST** keys simultaneously for 1 second minimum. The display changes to the "PV/Present SP monitor" parameter (level 0 mode).

3.7 Starting and Stopping Operation

RUN/RST

- To start program operation (that is, switch from the reset state to run operation), press the **RUN/RST** key for one second minimum.
- To stop program operation (that is, switch from run operation to the reset state), press the **RUN/RST** key for two seconds minimum. When the controller has stopped operating (reset state), the “RST” LED lights.
- The controller cannot be reset during auto-tuning (A.T.).

● Manipulated variable at reset

run-r

- On a standard type controller, specify the manipulated variable (-5.0 to 105.0%) in the “MV at reset” parameter (level 2 mode) to output the manipulated variable during reset. Default is “0.0:0.0%”.
- When the controller is reset in the manual mode, the manual MV takes precedence.
- Both the MV limiter and MV change rate limiter are ineffective against the manipulated value at reset.
- On a position-proportional type controller, you can select either of the open, closed or hold state. In an open state, only control output 1 is ON. In a closed state, only control output 2 is ON. In a hold state, both control outputs 1 and 2 are OFF. Default is “Hold”.



Using Event Input

On the E53-AKB, run/reset can be selected by event input.

For details on how to use event input, see 4.8 How to Use Event Input, page 4-21.

3.8 Adjusting Control Operation

■ Changing currently running programs

- Programs are changed in the program mode. Note that pattern Nos. cannot be changed during program operation. So, only the pattern that is currently running can be changed.
- You cannot change the program when the “security” parameter (protect mode) is set to “5” or “6”.

● Changing the SP

- Change the SP of steps 0 to 15 in “step 0 to 15 SP” parameters (program mode).
- When the SP is changed midway through a step, the Present SP is shifted on a line obtained by taking the new SP as the target point.

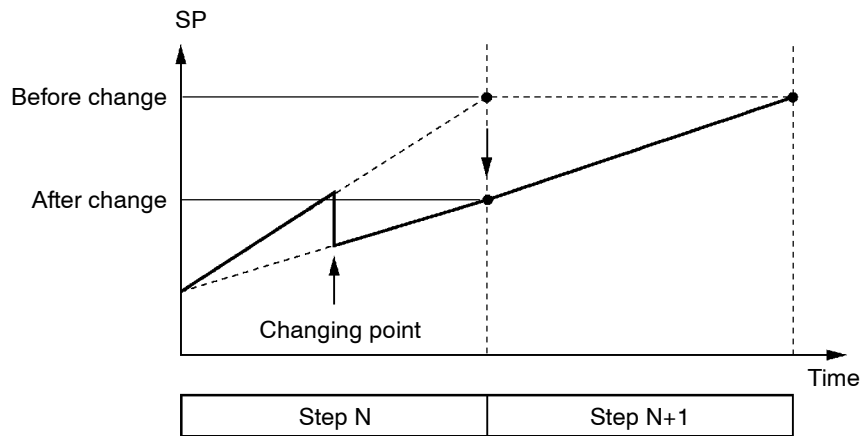

● Changing the time value

- Change the time value of steps 0 to 15 in “step 0 to 15 time” parameters (program mode).
- When the time value is changed midway through a step, the step time changes. The gradient of the line by which SP shifts also changes.

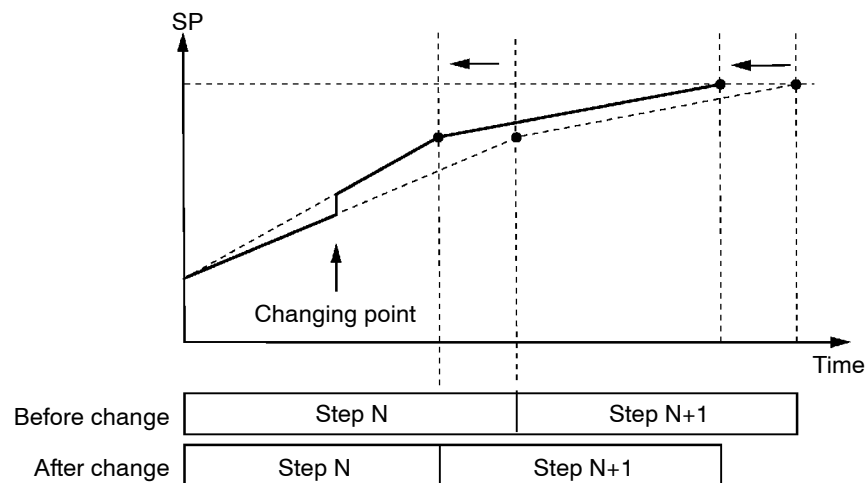

About Changing the Number of Steps

If you set the “number of steps” parameter (program mode) to a value smaller than the current number of steps during program operation, program operation is immediately exited.



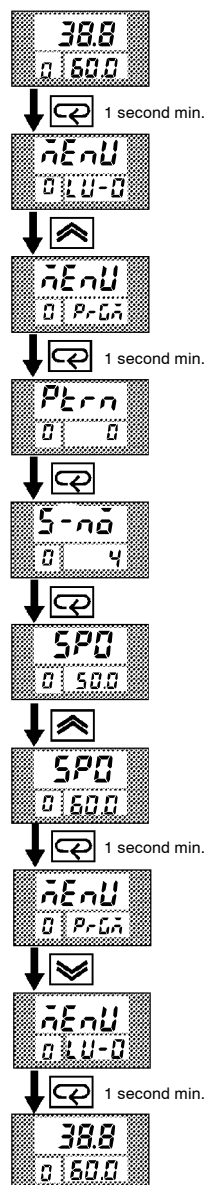

Setting Example

In the following example, let's change the temperature set point to "60°C" from "50°C".





- (1) Press the key for 1 second minimum at the currently executing "PV/Present SP" display.
- (2) The display changes to the menu display.
- (3) Set the parameter to "PrGr : program" pressing the or keys.
- (4) Press the key to enter the program mode. The top parameter in the program mode "PGrn : pattern" is displayed.
- (5) Press the key to display the [5-n0] ("number of steps" parameter).
- (6) Press the key. [SP0] ("step 0 SP" parameter) is displayed, and the No.2 display indicates "50.0".
- (7) Press the key to set the parameter to "60.0".
- (8) Press the key for 1 second minimum. The menu display ("PrGr : program" parameter) is redisplayed.
- (9) Select "LU-0 : level 0 mode" pressing the or keys, and press the key for 1 second minimum. The "PV/Present SP" display is redisplayed.

Manual operation



- On a standard type controller, the manipulated variable is controlled, and on a position-proportional type controller, the valve opening is controlled.
- To set manual operation and manually set the manipulated variable or the valve opening, press the  key and  key simultaneously for 1 second minimum. Then the controller enters the manual mode. To quit the manual mode, press the  key and  key again simultaneously for 1 second minimum. The controller enters the level 0 mode without entering the menu display.
- Though the control shifts to manual operation if the controller is set to the manual mode during program operation, the program advances. When program operation is started in the manual mode, program also advances.
- In the manual mode, the automatic return of display mode does not work.

Standard type

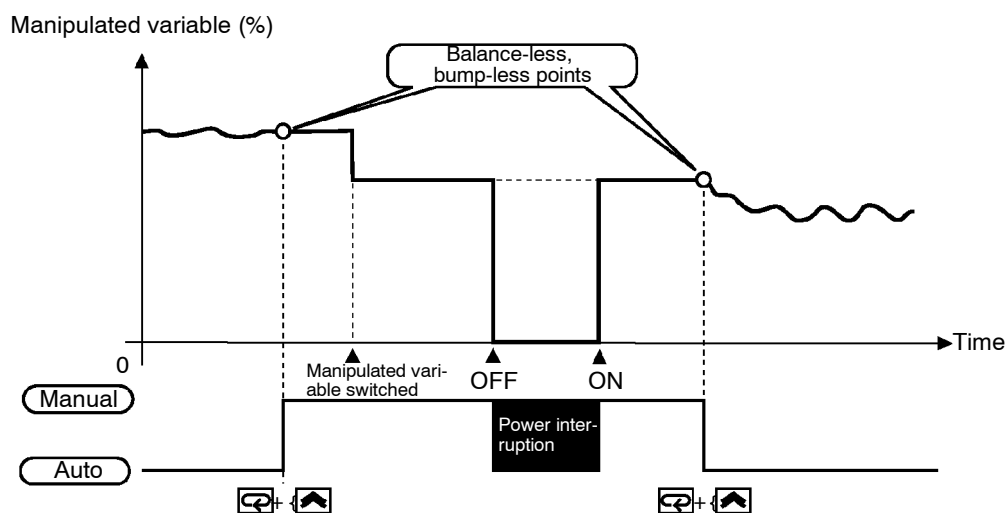
- The process value is displayed on the No.1 display, and the manipulated variable is displayed on the No.2 display.
- To change the manipulated variable, press the  or  keys. After two seconds, the manipulated variable is updated to the new setting.
- When switching between manual and auto operation, the manipulated variable is subject to balance-less, bump-less operation.
- If the power is interrupted during manual operation, manual operation is resumed at the manipulated variable that was active at power interruption when the power is reset.



Position-proportional type

- When a potentiometer is connected to the controller, the process value is displayed on the No.1 display, and the valve opening is displayed on the No.2 display.
- When you press the  key, the open side becomes ON. When you press the  key, the close side becomes ON.



Balance-less, Bump-less Operation

To prevent sudden changes in the manipulated variable when switching between manual and auto operation, operation is resumed using the value that was active immediately before operation was switched, and the value is brought gradually closer to the value immediately after operation was switched.

Auto-tuning (A.T.)



- AT (auto-tuning) cannot be executed while operation is reset or during ON/OFF control.
- When you execute auto-tuning, the optimum PID parameters are automatically set by forcibly changing the manipulated variable to calculate the characteristics (called the “limit cycle method”) of the control target. During auto-tuning, time counting is stopped and the “AT” LED flashes.
- 40%AT or 100%AT can be selected by the limit cycle of MV change width. Specify [At - 1] or [At - 2], respectively, in the “AT execute/cancel” parameter (level 1 mode).
- During heating and cooling control on a standard type controller, and on a position-proportional type controller, only 100%AT can be executed. (So, “At - 1 : 40%AT” is not displayed.)
- To cancel AT execution, specify “OFF : AT cancel”.

40%AT



In order to set the limit cycle of MV change width to 40%, select 40%AT to execute auto-tuning with fluctuations in the process value kept to a minimum. However, note that auto-tuning takes longer to execute compared with 100%AT.

The timing by which limit cycles are generated varies according to whether or not the deviation (DV) at the start of AT execution is 10% full-scale or less.

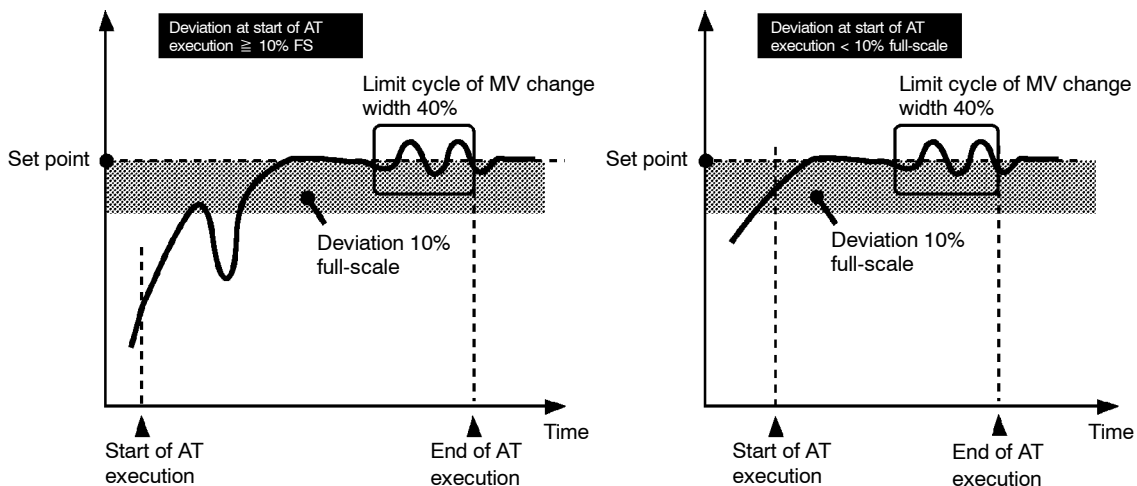

100%AT



In order to set the limit cycle of MV change width to 100%, select 100%AT to shorten the AT execution time without worrying about fluctuations in the process value.

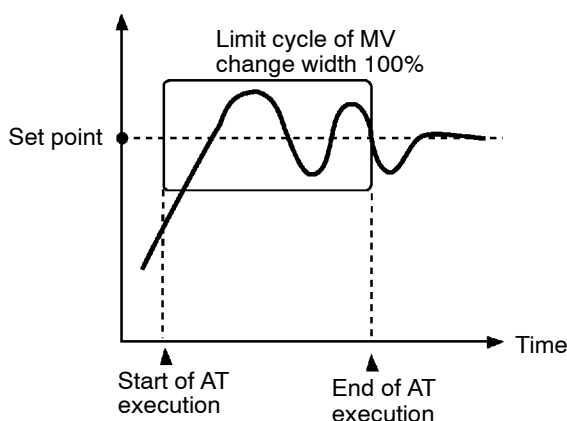

Setting Example

In this example, let's execute 40%AT.

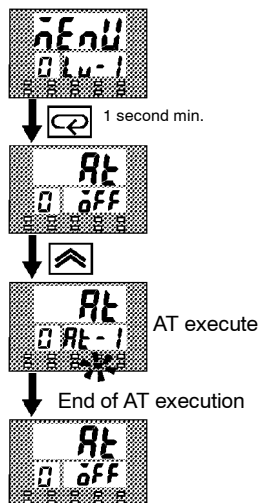

- (1) Select the menu display, and select “Lv - 1 : level 1 mode” using the or keys. For details on selecting the menu display, see page 1-10.
- (2) Press the key to enter the level 1 mode. The top parameter in the setup mode “ AT : AT execute/cancel” is displayed. In this example, the parameter setting is “ OFF : AT cancel”.
- (3) Press the key to specify “AT - 1 : 40%AT”.
- (4) The AT LED flashes, and AT execution starts. When the AT LED goes out (end of AT execution), the parameter automatically returns to “ OFF : AT cancel”.



About PID Parameters

When control characteristics are already known, the PID parameters can be set directly to adjust control.

PID parameters are set in the “proportional band” (P), “integrated time” (I) and “derivative time” (D) parameters (level 1 mode).

For details on the setting ranges of these parameters, see chapter 5 Level 1 Mode (page 5-18).



AT Execution Timing

The E5AK-T differs from fixed-value type controllers in that the SP changes automatically. So, the timing of AT execution is the most important factor in control.

To obtain PID parameters for a specific SP, make a fixed-value program as follows and execute AT.

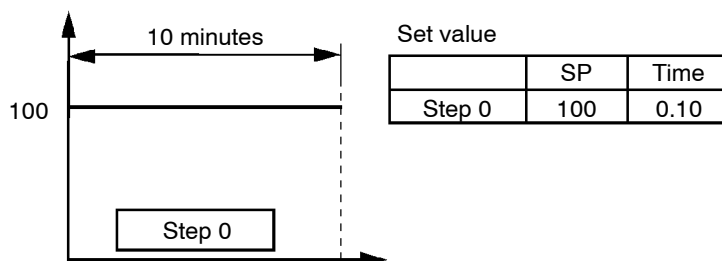

K CHAPTER 4

APPLIED OPERATION

This chapter describes each of the parameters required for making full use of the features of the E5AK-T.

Read this chapter while referring to the parameter descriptions in chapter 5.

4.1	Selecting the Control Method	4-2
	Heating and cooling control	4-2
	Position-proportional control	4-4
	ON/OFF control	4-5
4.2	Operating Condition Restrictions	4-7
	Manipulated variable restrictions	4-7
	Set point limiter	4-8
4.3	Ramp Rise Rate Setup Program	4-9
	Running the ramp rise rate setup program	4-11
	Program example	4-12
4.4	Program Operation	4-13
	Hold/Advance	4-13
	Pattern operation	4-14
4.5	Wait Operation	4-16
4.6	Program output	4-17
	Time signal	4-17
	Program output	4-18
4.7	Setting Running Conditions	4-19
	Operation at power ON	4-19
	Starting the program run	4-19
	End condition	4-20
4.8	How to Use Event Input	4-21
	Input assignments	4-21
	Detailed description of input functions ...	4-22
4.9	How to Use the Heater Burnout Alarm ...	4-23
	Heater burnout detection	4-23
	Operating conditions	4-23
	How to calculate the heater burnout set value	4-24
4.10	LBA	4-26
4.11	How to Use Transfer Output	4-28

4.1 Selecting the Control Method

■ Heating and cooling control

When selecting the control method, set the parameters according to the following table. (Parameters are factory-set to heating control.)

Control Method \ Parameter	Control Output 1 Assignment	Control Output 2 Assignment	Direct/Reverse operations
Heating control (Standard)	Control output (heat)	-	Reverse operation
Cooling control (Standard)	Control output (heat)	-	Direct operation
Heating and cooling control	Control output (heat)	Control output (cool)	Reverse operation

(Parameters are factory-set to heating control.)

- For details on how to assign outputs, see 3.3 Setting Output Specifications (page 3-7).
- When heating and cooling control is selected, the “dead band” and “cooling coefficient” parameters can be used.

● Dead band

The dead band is set with the set point as its center. The dead band width is the set value of the “dead band” parameter (level 1 mode). Setting a positive value produces a dead band, while setting a negative value produces an overlap band.

The dead band is factory-set to “0.00:0.00%FS.”

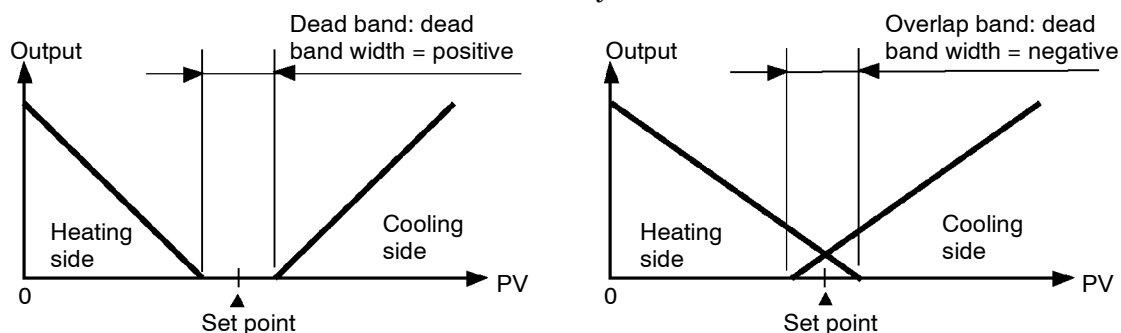

● Cooling coefficient

If the heating and cooling characteristics of the control target greatly differ, preventing satisfactory control characteristics from being obtained by the same PID parameters, adjust the proportional band (P at cooling side) using the cooling coefficient to balance control between the heating and cooling sides. In heating and cooling control, P at the heating or cooling side is calculated by the following formula:

$$\text{Heating side } P = P; \text{ Cooling side } P = \text{cooling coefficient} \times P$$

● Manipulated variable at reset

- In heating and cooling control, the manipulated variable output that is output when controller operation is stopped is dependent on the set value of the “MV at reset” parameter (level 2 mode) in the same way as for standard control.
- However, note that in heating and cooling control, the manipulated variable at the cooling side is treated as a negative value for the sake of convenience. When the manipulated variable at reset is a negative value, the manipulated variable is output to only the cooling side, and when a positive value, the manipulated variable is output to only the heating side.

Default is “0”. If the controller is operated with default, the manipulated variable is not output to both the heating and cooling sides.

**Switching with Manual Operation**

When the overlap band is set, the bumpless function that operates when switching between manual and automatic operation may not work.

Position-proportional control

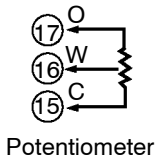
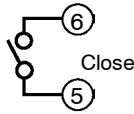
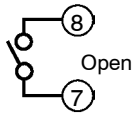

- Use the position-proportional type controller for position-proportional control.
- On a position-proportional type controller, control output 1 is used for open output, and control output 2 is used for closed output. Accordingly, control outputs 1 and 2 cannot be used as output assignments. Special output units are already set on position-proportional type controllers.
- On a position-proportional type controller, the following functions are disabled:
 - MV limiter
 - P and PD control
 - 40% AT
 - LBA
 - HBA
 - ON/OFF control

● Travel time

- To change the travel time, either set in the “travel time” parameter (option mode), or execute motor calibration in the “motor calibration” parameter (option mode).
- Default is “30:30 seconds.”

● Valve opening monitor

- The valve opening can be monitored when a potentiometer is connected to the controller. However, be sure to execute motor calibration after connecting the potentiometer.

● Manipulated variable at reset/PV error

- Open, closed or hold can be selected as output at reset or PV error. Set these outputs in the “MV at reset” or “MV at PV error” parameters (level 2 mode).

● Other functions

- Set the dead band in the “position-proportional dead band” parameter (level 1 mode). Default is “2.0:2.0%”.
- Set the open/close hysteresis in the “open/close hysteresis” parameter (level 2 mode).

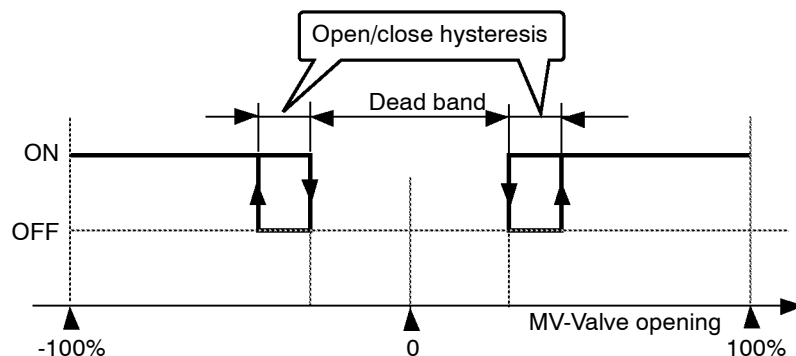

■ ON/OFF control

● Hysteresis

- Switching between advanced PID control and ON/OFF control is carried out by the “PID/ON/OFF” parameter (expansion mode). When this parameter is set to [P I D], advanced PID control is selected, and when set to [O N / O F F], ON/OFF control is selected. Default is [P I D].
- During position-proportional control, ON/OFF control cannot be selected.
- In ON/OFF control, hysteresis is provided in the program when switching between ON and OFF to stabilize operation. The hysteresis width provided during ON/OFF control is simply referred to as “hysteresis.” Control output (heat) and control output (cool) functions are set in the “hysteresis (heat)” and “hysteresis (cool)” parameters, respectively.
- In standard control (heating or cooling control), hysteresis can be set only for the heating side.

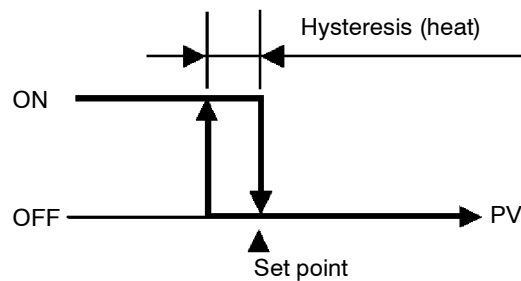

- In heating and cooling control, a dead band can be set. So, 3-position control is made possible.

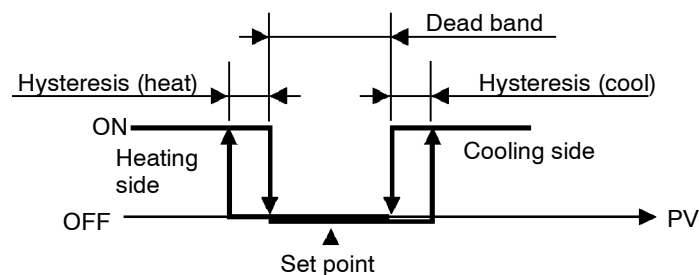

Parameters

Symbol	Parameter Name: Mode	Description
$\bar{o}U\bar{t}1$	Control output 1 assignment : Setup	For specifying control method
$\bar{o}U\bar{t}2$	Control output 2 assignment : Setup	For specifying control method
$\bar{o}r\bar{E}u$	Direct/reverse operation : Setup	For specifying control method
$\bar{C}-db$	Dead band : Level 1	Heating and cooling control
$\bar{C}-Sc$	Cooling coefficient : Level 1	Heating and cooling control
$\bar{n}u-r$	MV at reset : Level 2	Manipulated variable when control operation is stopped
$\bar{n}u-E$	MV at PV error : Level 2	Manipulated variable when control operation is PV error
$\bar{n}\bar{o}t$	Travel time : Option	Position-proportional control
$\bar{C}ALb$	Motor calibration : Option	Position-proportional control
db	Positional-proportional dead band : Level 1	Position-proportional control
$\bar{o}C-H$	Open/close hysteresis : Level 2	Position-proportional control
HYS	Hysteresis (heat) : Level 1	ON/OFF control
$\bar{C}HYS$	Hysteresis (cool) : Level 1	ON/OFF control
$\bar{C}n\bar{t}L$	PID / ON/OFF : Expansion	ON/OFF control

4.2 Operating Condition Restrictions

■ Manipulated variable restrictions

The upper- and lower-limit values of the manipulated variable can be restricted by the MV limiter, and the change rate of manipulated variable can be restricted by the MV change rate limiter.

● MV limiter

The upper- and lower-limit values of the manipulated variable are set in the “MV upper limit” and “MV lower limit” parameters (level 2 mode). When the manipulated variable calculated by the E5AK-T is outside of the range of the MV limiter, actual outputs are dependent on the set value of these parameters.

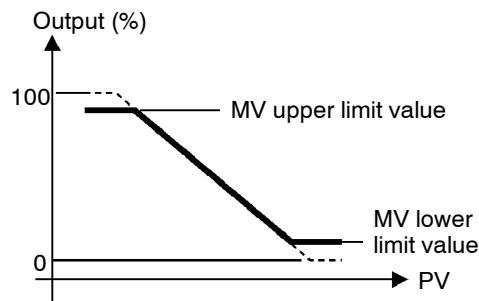

In heating and cooling control, the manipulated variable at the cooling side is treated as a negative value for the sake of convenience. The upper limit is set for the heating side (positive value), and the lower limit is set for the cooling side (negative value) as shown in the following figure.

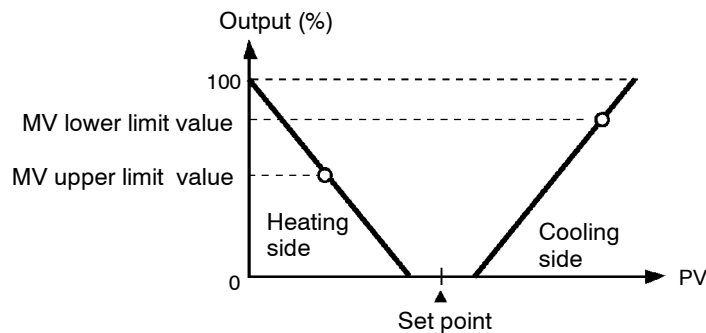

● MV change rate limiter

The “MV change rate limiter” parameter (level 2 mode) sets the maximum permissible change width per second of the manipulated variable. If a change in the manipulated variable exceeds this parameter setting, the value calculated by the E5AK-T is reached while changing the value by the per-second value set in this parameter.

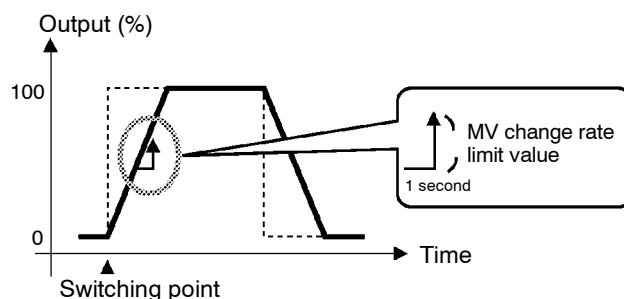

● **Limiter operation conditions**

The limiters are disabled or cannot be set when any of the following conditions occurs:

- During ON/OFF control
- During AT execution (only by MV change rate limiter)
- During manual operation
- When operation is stopped
- When an error has occurred
- During position-proportional control (manipulated variable limiter only)

■ **Set point limiter**

The setting range of the set point is limited by the set point limiter. The upper- and lower-limit values of this set point limiter are set in the “set point upper limit” and “set point lower limit” parameters (expansion mode), respectively. However, note that when the set point limiter is reset, the set point is forcibly changed to the upper- or lower-limit value of the set point limiter if the set point is out of the limiter range. Also, when the input type, temperature unit and scaling (sensor) range are changed, the set point limiter is forcibly reset to the scaling (sensor) range.

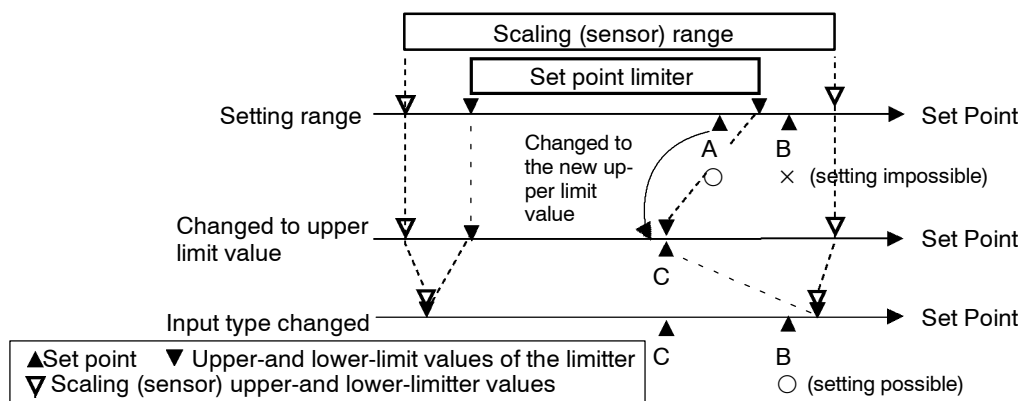

Parameters

Symbol	Parameter Name: Mode	Description
$\bar{o}L-H$	MV upper limit : Level 2	For limiting manipulated variable
$\bar{o}L-L$	MV lower limit : Level 2	For limiting manipulated variable
$\bar{o}rL$	MV change rate limit : Level 2	For limiting manipulated variable
S_L-H	Set point upper limit : Expansion	For limiting SP setting
S_L-L	Set point lower limit : Expansion	For limiting SP setting

4.3 Ramp Rise Rate Setup Program

Chapter 3 described programs that used the “time setup method.” Programs were executed using a combination of SPs and step time values. The E5AK-T also supports the “ramp rise rate setup method.” By this method, programs are executed using three program elements: “target SP”, “rate of rise” and “soak time.”

To select a ramp rise rate program, set the “Step time/rate of rise programming” parameter (expansion mode) to “Pr : rate of rise.”

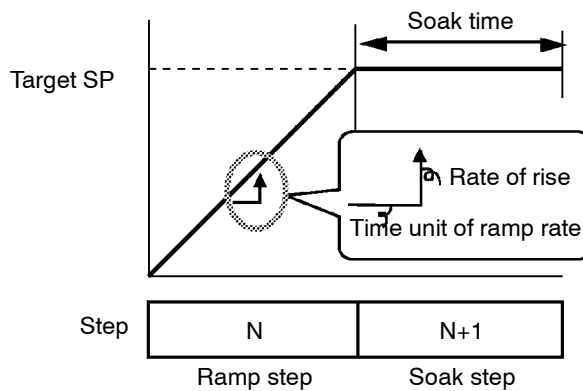

Set each of the above program elements in the “target SP 0 to 7”, “rate of rise 0 to 7” and “soak time 0 to 7” parameters.

In a ramp rise rate program, parameters are set to two steps as shown in the figure above. The following figure shows the relationship between the program and parameters.

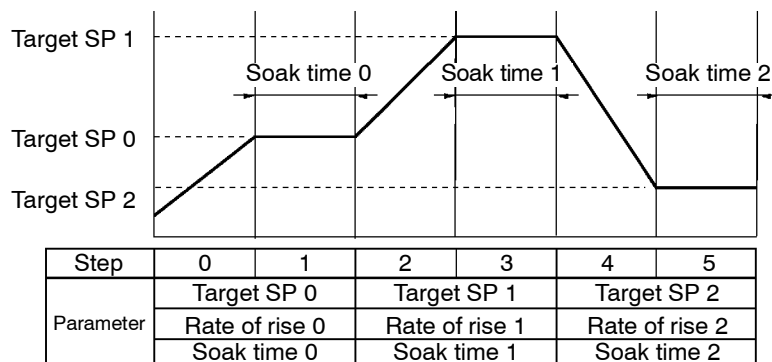

● **Relationship with the number of steps**

When the number of steps is set to an odd number, the final soak time cannot be set. For example, if we set the “number of steps” parameter to “7”, the “soak time 3” parameter cannot be set even though the “target SP 3” and “rate of rise 3” parameters can be set.

Accordingly, when the number of steps are set to an even number, the final step is a soak step. When it is set to an odd number, the final step is a ramp step.

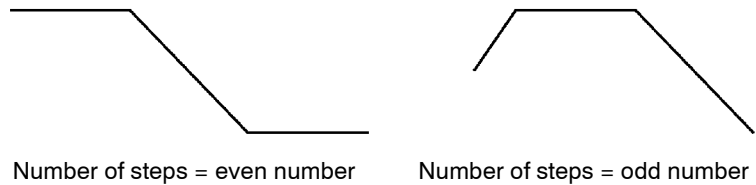

● **When the rate of rise is set to “0”**

When “rate of rise 0 to 7” parameter is set to “0”, the ramp step is skipped and the soak step appears to be continuous.

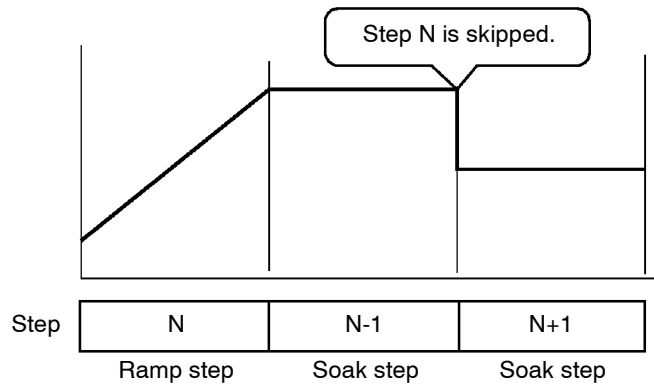

■ Running the ramp rise rate setup program

● Changing parameters

Ramp rise rate setup programs take the PV at start of program operation as the SP (PV start) when they are started.

When the rate of rise is changed midway during operation, the SP rate of rise and the step time in the ramp cycle both change.

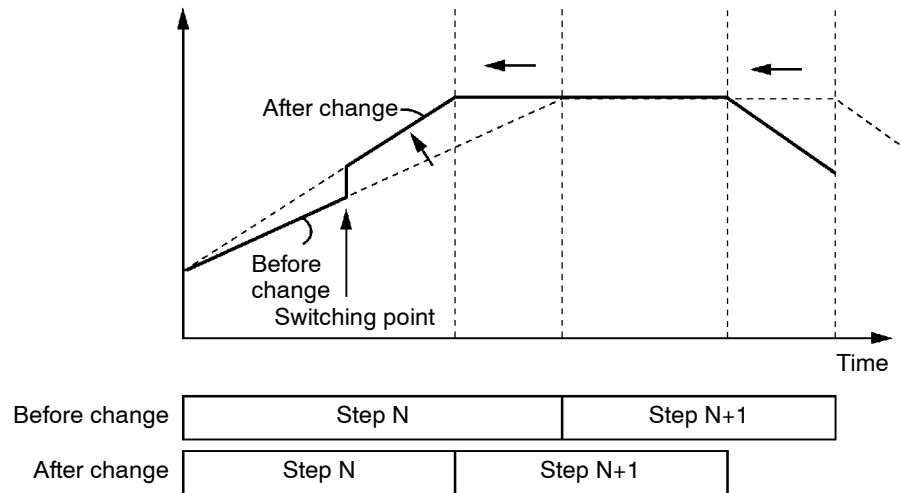

- In the above figure, increasing the rate of rise results in a shorter target step time. Likewise, when the SP is changed, the step time of the ramp cycle also changes.
- When the soak time is changed, only the step time in the soak cycle changes.

Program example

Let's describe a typical example of a ramp rise rate setup program. In an actual program, set the parameters to match the application.

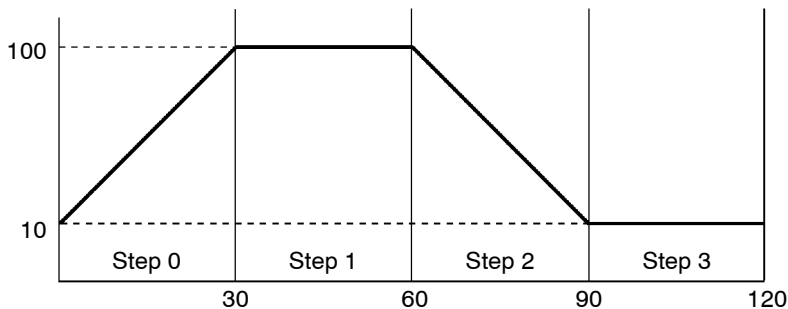

Target SP 0 : 100	Target SP 1 : 10
Rate of rise 0 : 3	Rate of rise 1 : 3
Soak time 0 : 0.30	Soak time 1 : 0.30

"Number of steps" = 4, "Time unit of ramp rate" = minutes, "PV start" = 10

Program structure

In a program comprising four steps, steps 0 and 1 follow the settings of the "target SP 0", "rate of rise 0" and "soak time 0" parameters. Steps 2 and 3 follow the settings of the "target SP 1", "rate of rise 1" and "soak time 1" parameters.

How the program works

- (1) As the program starts at PV (PV start), the program starts operation from "10" in this example.
- (2) As the rate of rise is set to "3", the Present SP takes 30 minutes ($100-10/3=30$) to reach the target SP value "100" in step 0. If the PV is "40" when the program is started, this time then becomes 20 minutes using the same formula.
- (3) In step 1, the Present SP does not change, and the step time is the value set to the "soak time 0" parameter (in this example, "30 minutes").
- (4) In step 2, the Present SP changes according to the value of "rate of rise 1" parameter from that of "target SP 0" parameter to that of "target SP 1" parameter. It takes 30 minutes in this example.
- (5) In step 3, the Present SP does not change, and the step time is the value set to the "soak time 1" parameter (in this example, "30 minutes").

Parameters

Symbol	Parameter Name: Mode	Description
$t - P_r$	Step time/Rate of rise programming : Expansion	Ramp rise rate
$SP *$	Target SP 0 to 7 : Program	Ramp rise rate
$P_r *$	Rate of rise 0 to 7 : Program	Ramp rise rate
$t_s *$	Soak time 0 to 7 : Program	Ramp rise rate

* : 0 to 7



Operation at Input Error

By ramp rise rate setup method, starting at input error, the program start step is the "step 1".

4.4 Program Operation

■ Hold/advance

- Steps in currently executing programs can be forcibly stopped (Hold) and advanced (Advance).
- Hold and Advance operation is according to the following procedure:

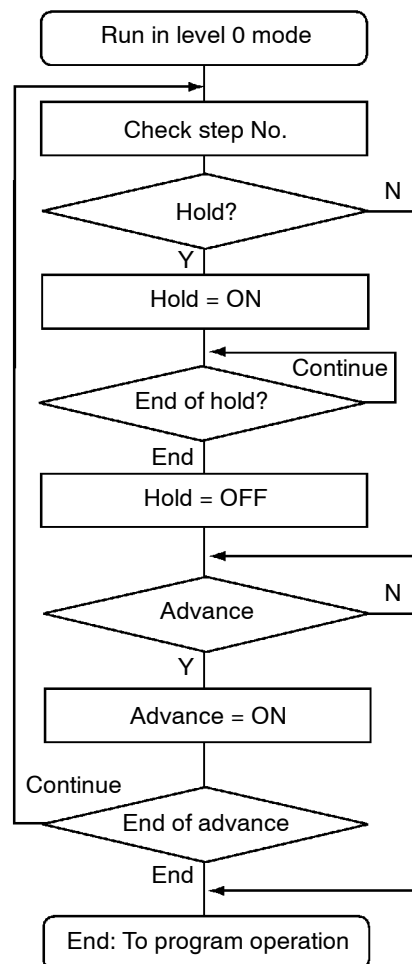

- Execute hold/advance operation while making sure the step No. in the “step No. monitor” parameter (level 0 mode).
- When the “hold” parameter (level 0 mode) is set to “ $\bar{0}n$: ON”, step time counting is paused (Hold), and the “HOLD” LED lights. “HOLD” and the SP appear alternately on the No.2 display when in the “PV/ Present SP” parameter.
- Hold is canceled time and counting is restarted by one of the following conditions: “hold” parameter = “ $\bar{0}FF$: OFF”, Run, Reset, End operation using advance instruction
- Each time that “advance” parameter (level 0 mode) is set to “ $\bar{0}n$: ON”, the program advances one step. With each step advance, the “Advance” parameter setting returns to “ $\bar{0}FF$: OFF”.
- If the advance function is executed with the program in a hold state, the hold state is continued in the next step.

■ Pattern operation

● Repeating execution of the same pattern

- To repeatedly execute the same pattern, set the number of times that the pattern is to be executed in the “pattern execution count” parameter (program mode).
- The pattern execution count can be set up to 9999 (times). (Default is “0”.)
- Patterns for which the “pattern execution count” parameter is set to “0” cannot be executed.
- The count of the currently executing pattern in the program can be verified in the “pattern execution count monitor” parameter (level 0 mode). “0” is indicated in this parameter when the controller of reset or in a standby state.

● Executing all patterns

- To execute all preset patterns in order from pattern 0, set the “run all enable” parameter (expansion mode) to “ $\bar{0}$: ON”. (Default is “ $\bar{0}$ FF : OFF”.)

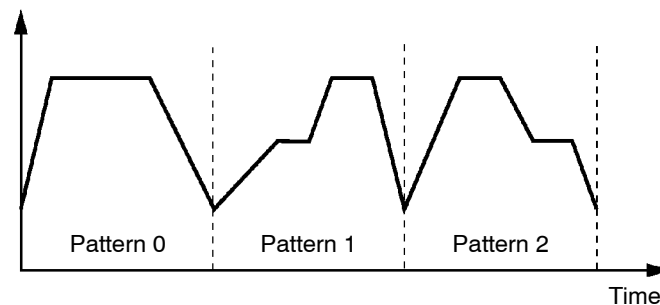

- When a power interruption occurs during run all execution, if the “operation at power ON” parameter (expansion mode) is set to “ $\bar{1}$ $\bar{0}$ $\bar{0}$: Continue”, the currently executing pattern No. is held in memory. When power is restored, program operation resumes from the pattern that was being executed when the power was interrupted. (For details on operation at power ON, see page 4-19.)
- Patterns whose “pattern execution count” is set to “0” are skipped.

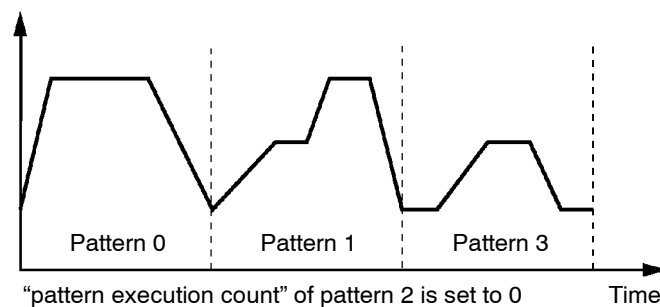

Parameters

Symbol	Parameter Name: Mode	Description
<i>HOLD</i>	Hold : Level 0	Pauses program execution.
<i>Adv</i>	Advance : Level 0	Advances the program one step.
<i>rPt</i>	Pattern execution count : Program	Repeatedly executes current pattern.
<i>rUnA</i>	Run all :Expansion	Executes all patterns.



About Reset

- A reset cancels a hold state.
- When the controller is reset during run all execution, the program returns to step 0 of the currently executing pattern.

4.5 Wait Operation

- “Wait” is the operation of not advancing the program steps and waiting for the PV to enter the preset wait width at the end of each step. During wait operation, the “WAIT” LED lights.

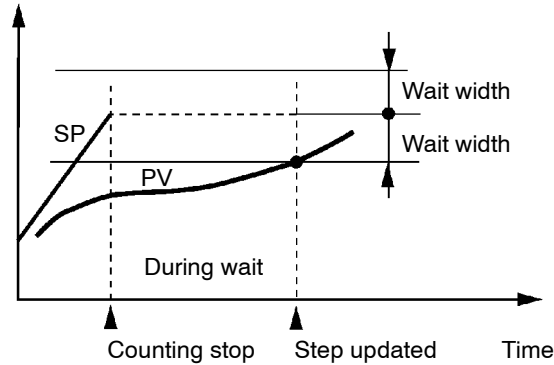

- As the PV is smaller than “SP - wait width” at the end of the rising step in the above figure, control monitoring is stopped, and the control waits for PV to reach “SP - wait width” before the step is updated.
- In the case of a falling step, the control waits for PV to reach “SP + wait width.”
- Set the wait width in the “wait width” parameter (expansion mode) within the range 0 to 9999 (EU). (Default is “0”.)
- Setting the “wait width” to “0” disables wait operation.

Parameters

Symbol	Parameter Name: Mode	Description
$\underline{Wt-w}$	Wait width : Expansion	Wait operation

4.6 Program output

- The E5AK-T outputs the following signals according to how far the program has elapsed:
 - Time signal 1/2
 - Program end
 - Stage output
- These functions can be used only when they have been assigned as outputs.

■ Time signal

- Two types of time signals can be set to each pattern.

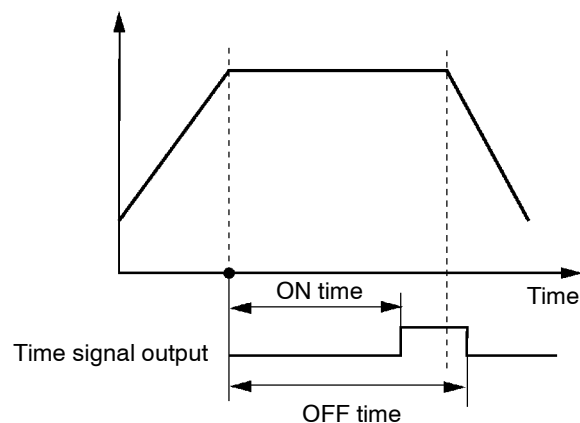

- There are two timers for time signals: ON time timer and OFF time timer. These times are counted from the beginning of the step.
- Output is ON from the ON time elapsed point up to the OFF time elapsed point.
- Set the step at which to output the time signal in the “time signal 1/2 enabled step” parameter (program mode). (Default is “0: step 0.”)
- Set the ON/OFF timing in the “time signal 1/2 ON time” and “time signal OFF time” parameters (program mode).

● About ON conditions

- When the OFF time is set shorter than the ON time, output is ON until a reset from the ON time elapsed point onwards or at start of the next pattern.
- Output does not turn ON when ON and OFF times are set the same.
- When step advance is executed during execution of the time signal enabled step, the controller judges that the time equivalent to the enabled step has elapsed. For example, in the above figure, output is ON from the start of the following step up to the OFF time elapsed point.



About Pattern Elapsing Time

You can verify the pattern elapsing time in the “pattern elapsing time” parameter (level 0 mode). During repeated execution of patterns or run all execution, the program is counting for each pattern.

If the count exceeds the monitor range (99 hours:59 minutes or 99 minutes:59 seconds), “99.59” is displayed flashing.

During Hold, time counting is paused.

Executing Advance, the skipped step time is counted.

Program status

● Program end

- One-second pulse signal is output after the final step is completed.

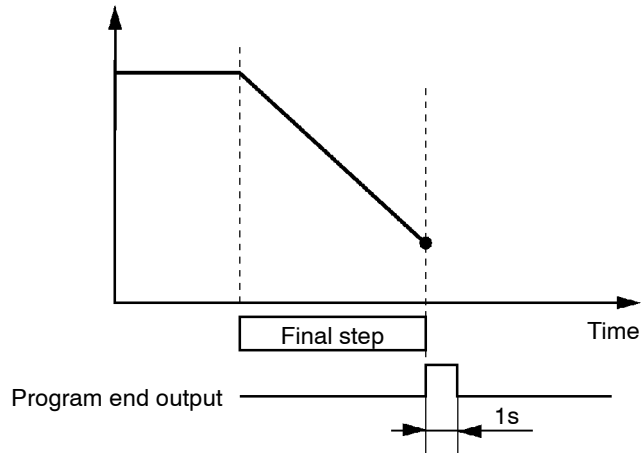

● Stage output

- One-second pulse signal is output at the beginning of each step.

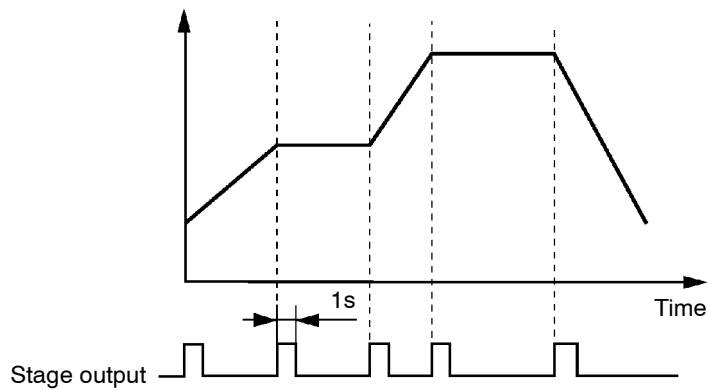

Parameters

Symbol	Parameter Name: Mode	Description
tS^*S	Time signal*set step : Program	Time signal
\bar{on}^*	Time signal*ON time : Program	Time signal
\bar{of}^*	Time signal*ON time : Program	Time signal
\bar{out}^*	Control output*assignment : Setup	Program status
SUb^*	Auxiliary output*assignment : Setup	Program status

*: 1 to 2

4.7 Setting Running Conditions

■ Operation at power ON

- You can select from one of the following operations at power ON: Continue, Reset, Run, Manual
- If you select “Continue,” operation is started from the state that was active when power was interrupted.
- If you select “Reset,” the controller is reset.
- If you select “Run,” normal program operation is started.
- If you select “Manual,” the controller enters the manual mode.
- The following table shows the relationship between operation at power ON and the operation details that are stored to memory when a power interruption occurs.

	Continue	Reset	Run	Manual
Pattern No.	○	○	○	○
Step No.	○	-	-	○
Pattern elapsing time	○	-	-	○
Pattern execution count	○	-	-	○
Hold status	○	-	-	○
Auto/Manual	○	○	○	-
Run/Reset	○	-	-	○
MV at reset *1	○	-	-	○
Manual MV *2	○	○	○	○

*1 During auto mode at power interruption on a standard type controller

*2 During manual mode at power interruption on a standard type controller

- Set the desired operation in the “operation at power ON” parameter (expansion mode). Default is “ $\text{E}07$: Continue”.

Starting the program run

PV start

- When the program is configured by the time setup method, a ramp-priority “PV start” can be selected as one of the run start conditions. If you select “PV start” in the “PV start” parameter (expansion mode), program operation is started from the position of the SP that first matches the PV when program run is started. If the SP does not match the PV, the program run is started from the beginning.

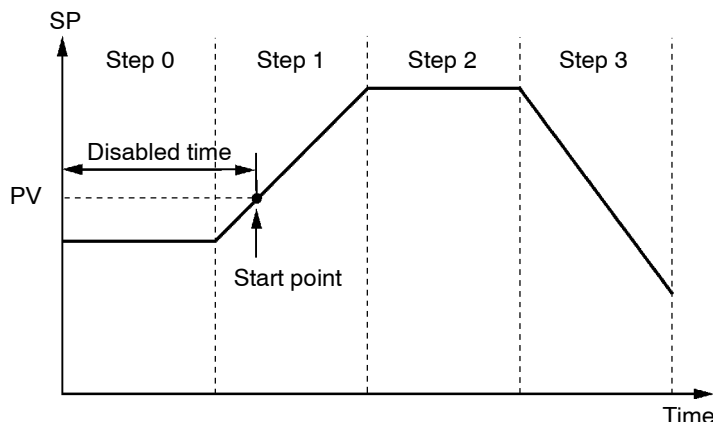

Standby operation

- After the run instruction, the controller is reset until the standby time elapses.
- Set the standby time in the “standby time” parameter (level 2 mode) within the range 0.00 to 99.59 (hours:minutes). Defaults is “0.00”.

End condition

- After end of operation, the controller normally is reset. However, control can be continued on the SP of the final step by setting the “end condition” parameter (expansion mode). If the “end condition” is set, the SP of the final step and [P.End] appears alternately on the No.2 display.
- When the “number of steps” parameter is changed after operation has ended, the controller state does not change state. However, if control with respect to the SP is continued, the SP switches to the new value of the final step.

Parameters

Symbol	Parameter Name: Mode	Description
P-on	Operation at power ON : Expansion	Operation when power is turned ON
PVSt	PV start : Expansion	Start of program run
Stb	Standby time : Level 2	Start of program run
ESSt	End condition : Expansion	Operation end program run

4.8 How to Use Event Input

- When using event input, mount the option unit (E53-AKB).
up to two E53-AKB units can be mounted on the E5AK-T, and two event input can be used for each E53-AKB unit.
E53-AKB × 1 unit : 2 event inputs
E53-AKB × 2 unit : 4 event inputs
- Switching by event input is not possible on the menu display.
- Switch event inputs ON and OFF while controller power is ON.

Input assignments

- You can choose from the following six event input functions:
Run/Reset
Remote/Local
Auto/Manual
Hold/Hold cancel
Advance
Pattern select
- Event input ON/OFF judgment is carried out on inputs of 200 ms minimum.
- When event inputs are used as program advance input, the program step is advanced at the rising (OFF→ON) edge of the input signal. When event inputs are used as run/reset input, program operation is stopped (reset) at the rising (OFF→ON) edge of the input signal, and program operation is started (run) at the falling (ON→OFF) edge. Other signals are accepted at all times.
- Set event input assignments in the “event input assignments 1 to 4” parameters (option mode). However, note that “event input assignment 1/2” parameters cannot be used when only one unit of the E53-AKB is installed.
- The following table shows the relationship between the settings and functions of the “event input assignment 1 to 4” parameters.

Setting	Function
<i>nōn</i>	Event input disabled
<i>rSt</i>	OFF→ON: Reset /ON→OFF: Run
<i>rnt</i>	ON: Remote /OFF: Local
<i>rAn</i>	ON: Manual /OFF: Auto
<i>HōLd</i>	ON: Hold /OFF: Hold cancel
<i>Rdu</i>	Execute at OFF→ON
<i>Ptn0</i> <i>Ptn1</i> <i>Ptn2</i>	Specify by combination of three inputs (*1).

*1 The following table shows the relationship between pattern select No. and pattern No.

Pattern No.	0	1	2	3	4	5	6	7
Pattern select 0		○		○		○		○
Pattern select 1			○	○			○	○
Pattern select 2					○	○	○	○

Detailed description of input functions

● Run/Reset



- There is no order of priority in event input, key operations and communications command setup. However, remote/local, auto/manual, hold/hold cancel or pattern selection be set to either of ON or OFF. So, parameters will always follow event input even if you try to switch settings by key operation and communications commands.

- Program operation is stopped (reset) at the rising (ON→ON) edge of the event input signal, and the “RST” LED lights. Program operation is started (run) at the falling (ON→OFF) edge of the event input signal.

● Remote/Local

- This function is supported only when E53-AK01/02/03, the option unit for serial communications, is installed.
- Remote/local cannot be assigned in the “event input assignment 1/2” parameters.
- When event input is set to “ON”, parameters can be written only by using the communications function, and the “RMT” LED lights. The content of event input is reflected in the “remote/local” parameter (level 2 mode).
- Remote/local can be switched up to 100,000 times.

● Auto/Manual

- When event input is set to “ON”, the controller is switched to manual operation, and the “MANU” LED lights.

● Hold/Hold cancel

- This function is enabled only during program operation.
- The program is paused (Hold) when the event input is ON, and the “HOLD” LED lights. Holds continue until the state of the event input changes to OFF.

● Advance

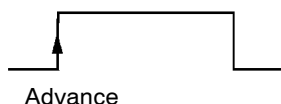

- This function is enabled only during program operation.
- Program steps are advanced at the rising (OFF→ON) edge of the event input signal. Accordingly, be sure to set event input OFF before you use this function.

● Pattern select

- This function is enabled only when the program is reset.
- Patterns are selected using a combination of pattern select 0 to 2.
- Pattern select 0 to 2 inputs that are not assigned are normally treated as OFF. For example, when only pattern select 1 is assigned, pattern select inputs 0 and 2 are treated as OFF, so pattern 0 and 2 are patterns targeted for switching.

Parameters

Symbol	Parameter Name: Mode	Description
E ₁₋₄ *	Event input assignments 1 to 4: Option	Event input functions

*: 1 to 4

4.9 How to Use the Heater Burnout Alarm

■ Heater burnout detection

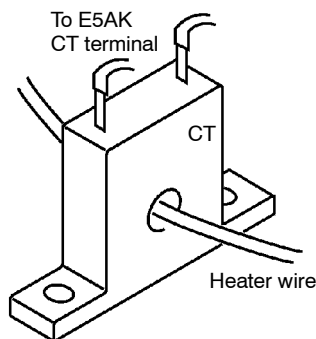

● HBA latch/release

■ Operating conditions

- On a standard type controller, the HBA (heater burnout alarm) function can be used only when the assignment destination of the output function “control output (heat)” is set to pulsed output.
- When using the HBA function, assign output function “heater burnout alarm” to control outputs 1/2 or auxiliary outputs 1/2.
- Heater burnout detection works as follows:
 - (1) Connect the current transformer (CT) to terminal Nos.15 and 17, and insert the heater lead through the CT hole.
 - (2) When current flows through this lead, the current transformer generates AC current proportional to the current value. The E5AK measures this AC current to calculate the current flowing to the heater.
 - (3) If the heater is burned out, the current measured at the current transformer decreases. This value is compared with the value set as the heater burnout set value and is output as the heater burnout alarm.
- Set the heater burnout set value in the “heater burnout alarm” parameter. To verify the current value of the current transformer, use the “heater current monitor” parameter.
- When you are not using the HBA function, set the “heater burnout alarm” parameter to “0.0 (disabled)”.
- When the HBA latch function is set to “ON”, the heater burnout alarm is held until either of the following measures is taken:
 - a Set the heater burnout set value to “0.0A” (default).
 - b Reset the controller.
(Turn the controller’s power OFF then back ON again.)
- To enable the HBA latch function, set the “HBA latch” parameter to “ON”.
- Turn the heater power supply ON at the same time as or before turning the E5AK-T power supply ON. If the heater power supply is turned ON after turning the E5AK-T power supply ON, the heater burnout alarm is output.
- Control is continued even when the heater burnout alarm is output. (That is, the controller attempts to control the heater as if the heater burnout alarm has not occurred.)
- The heater burnout alarm is detected only if the control output is continuously ON for 190 ms minimum.
- The rated current value may sometimes differ slightly from the actual current value flowing to the heater. Verify the current value in an actual operating state in the “heater current monitor” parameter.
- If there is little difference between the current in a normal state and the current in a burnout state, detection may become unstable. On a heater of current 10.0 A or less, maintain a difference of 1.0 A minimum. On a heater of current 10.0 A minimum, maintain a difference of 2.5 A minimum.

- The heater burnout alarm function cannot be used when the heater is controlled by a phase control system or by a cycle control system. Also, the heater burnout alarm function cannot be applied on 3-phase heaters.

To detect heater burnout on a 3-phase heater, use the K2CU-F□□A-□GS (with gate input terminal). (For details, see the respective product catalog.)

■ How to calculate the heater burnout set value

- Calculate the set value by the following formula:

$$\text{Set value} = \frac{(\text{current value at normal operation} + \text{current value at burnout})}{2}$$
- Set the current value at burnout when two or more heaters are connected to the CT to the value at the time that the heater having the smaller(est) current value burns out (the value when one of the heaters burns out with all heaters at the same current).
- Make sure that the following condition is satisfied:
 - Heater of current 10.0 A or less
 Current value at normal operation - current value at heater burnout ≥ 1 A
 When resultant current is less than 1 A, detection is unstable.
 - Heater of current 10.0 A minimum
 Current value at normal operation - current value at heater burnout ≥ 2.5 A
 When resultant current is less than 2.5 A, detection is unstable.
- The set value can be set within the range 0.1 to 49.9 A. Heater burnout is not detected when the setting is “0.0” or “50.0”. When the setting is “0.0”, the heater burnout alarm is set to “OFF,” and when the setting is “50.0”, the heater burnout alarm is set to “ON.”
- Set the total current value at normal heater operation to 50 A or less. When set to 55.0 A minimum, [F F F F] is displayed in the “heater current monitor” parameter.

● Examples of use

Example 1 : when using a 200 VAC, 1 kW heater

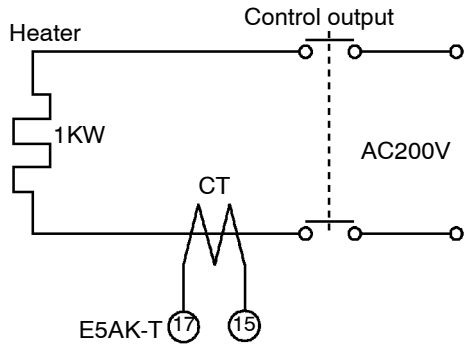

$$\text{Current at normal operation} = \frac{1000}{200} = 5\text{A} (< 10\text{A})$$

$$\text{Current at heater burnout} = 0\text{A}$$

$$\text{Set value} = \frac{5+0}{2} = 2.5\text{A}$$

$$(\text{current at normal operation} - \text{current at heater burnout}) = 5 - 0 = 5\text{A} (\geq 1\text{A})$$

Example 2 : when using three 200 VAC, 1 kW heaters

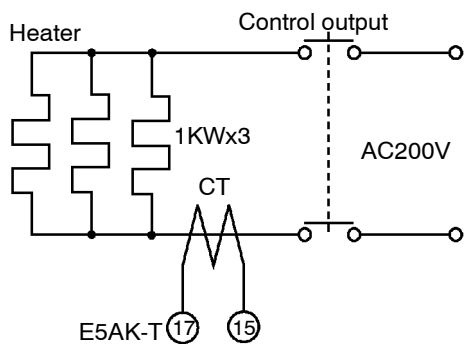

$$\text{Current at normal operation} = \frac{1000}{200} \times 3 = 15\text{A} (\geq 10\text{A})$$

$$\text{Current at burnout of one heater} = \frac{1000}{200} \times 2 = 10\text{A}$$

$$\text{Set value} = \frac{15+10}{2} = 12.5\text{A}$$

$$(\text{current at normal operation} - \text{current at heater burnout}) = 15 - 10 = 5\text{A} (\geq 2.5\text{A})$$

Parameters

Symbol	Parameter Name: Mode	Description
CT	Heater current monitor : Level 1	Heater current value monitor
Hb	Heater burnout detection : Level 1	Heater burnout detection
HbL	Heater burnout latch : Option	Heater burnout detection alarm latch

4.10 LBA

● LBA detection time

● LBA detection width

● LBA detection example

- The LBA (Loop Break Alarm) function can be used only on standard type controllers.
- The LBA function can be used only when it is assigned as an output. Also, the LBA function does not work when a memory error or A/D converter error results.
- LBA (Loop Break Alarm) is a function for judging that an error has occurred somewhere on the control loop and for outputting an alarm when the process value does not change with the manipulated variable at a maximum or minimum state. Accordingly, the LBA function can be used as a means for detecting a malfunctioning control loop.
- Normally, when output is set to maximum or minimum, the process value rises or falls after the dead time has elapsed. LBA is output if the process value does not change in the predicted direction after a fixed amount of time has elapsed. This fixed amount of time is the “LBA detection time.”
- LBA operation sometimes becomes unstable when the process value fluctuates considerably due to the control characteristics. The LBA detection width is provided so that changes with respect to output can be correctly detected. Changes smaller than the detection width due to LBA detection timing are not regarded as changes.
- The following example describes what happens when a heater burn-out occurs at maximum output.

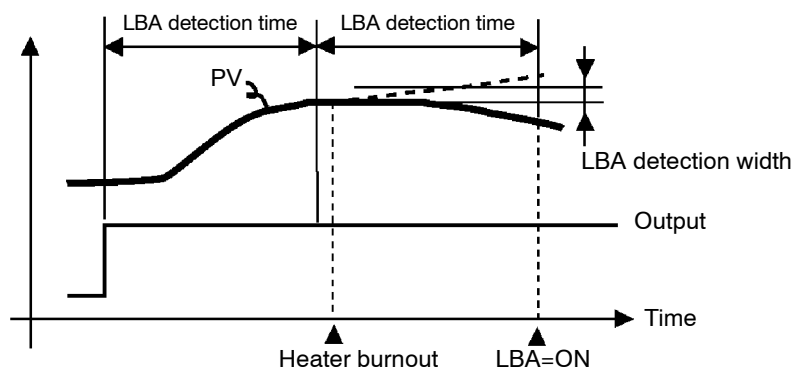

- LBA judgment is carried out at each LBA detection time from the point of maximum output. In the above figure, the process value (PV) is changing greatly at the 1st judgment time band, so LBA remains OFF.
- At the 2nd judgment time band, the process value increases as indicated by the broken line if the process value is normal. This means that the change width exceeds the LBA detection width, and LBA output remains OFF.
- If the heater burns out at the point shown in the above figure, the process value “decreases.” Accordingly, it is judged that “the process value is not changing in the increasing direction” at the 2nd judgment time band and the LBA output becomes ON.

● Setting the LBA detection time

- The LBA detection time is automatically set by auto-tuning (except in heating and cooling control).
- If the optimum LBA detection time cannot be obtained by auto-tuning, set the time in the “LBA detection time” parameter (level 2 mode).

● Determining the LBA detection time

- Calculate the LBA detection time as follows:
 - (1) Set output to maximum.
 - (2) Measure the time it takes for the input change width to reach the LBA detection width (factory setting: 0.2% FS).

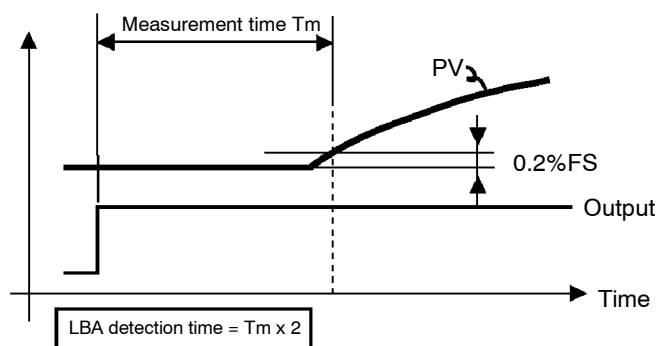

- (3) Take a value twice that of the measurement time as the LBA detection time.

Parameters

Symbol	Parameter Name: Mode	Description
At	AT execute/Cancel : Level 1	For automatic setting of LBA detection time
LbA	LBA detection time : Level 2	For setting LBA detection time
LbAb	LBA detection width : Expansion	For changing LBA detection width

4.11 How to Use Transfer Output

● Transfer output type

- When using transfer output, add on the communications unit (E53-AKF).
- You can select the following five data items in the “transfer output type” parameter (option mode) as the transfer outputs:
Present SP (default), Process value, Manipulated variable (heat), Manipulated variable (cool), Valve opening

However, note that heating/cooling side manipulated variables can be output only on standard type controllers, and valve opening can be output on position-proportional type controllers.

- If the output assignment is changed when either the “manipulated variable (heat)” or “manipulated variable (cool)” parameter is selected, the factory setting “set point” is returned to.

● Transfer output scaling

- These transfer outputs can be scaled according to the settings of the “transfer output upper limit” and “transfer output lower limit” parameters before output. Setting of an upper limit value smaller than the lower limit value is allowed, so reverse scaling can also be carried out. Also, the scale can be enlarged by the upper- and lower-limit width specified for each data item. The following example shows scaling of the heating side manipulated variable.

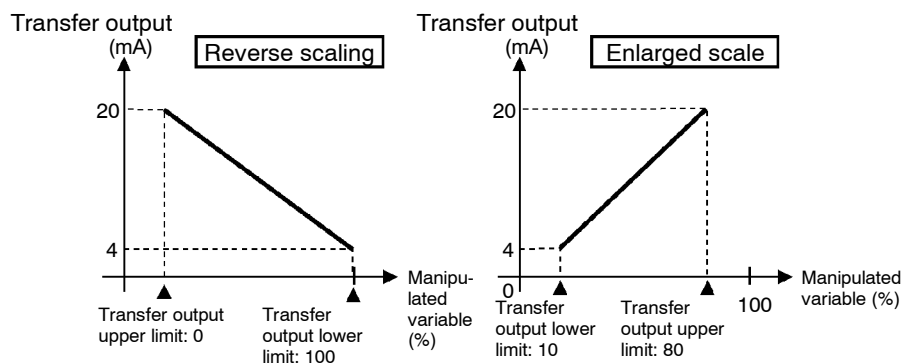

Parameters

Symbol	Parameter Name: Mode	Description
$t_r - t$	Transfer output type : Option	Transfer output designation
$t_r - H$	Transfer output upper limit : Option	Transfer output scaling
$t_r - L$	Transfer output lower limit : Option	Transfer output scaling

K CHAPTER 5

PARAMETERS

This chapter describes the parameters of the E5AK-T.
Use this chapter as a reference guide.

Conventions Used in this Chapter	5-2
Protect Mode	5-3
Manual Mode	5-5
Level 0 Mode	5-6
Program Mode	5-11
Level 1 Mode	5-17
Level 2 Mode	5-24
Setup Mode	5-30
Expansion Mode	5-38
Option Mode	5-46
Calibration Mode	5-52

Conventions Used in this Chapter

■ The meaning of icons used in this chapter



Function

Describes the functions of the parameter.



Setting

Describes the range and defaults of the parameter setting.



Monitor

Used for monitor-dedicated parameters.
Describes the range of the monitor values.



Example
of use

Describes a procedure using parameters in operating instructions.



See

Describes related parameters and items.



Model

Describes models of the E5AK-T or optional units that support the parameter being described.

■ About parameter display

On the E5AK-T controller, only parameters that can be used are displayed. These parameters are displayed only when the “Conditions of Use” on the right of the parameter heading are satisfied. However, note that the settings of protected parameters are still valid, and are not displayed regardless of the conditions of use.

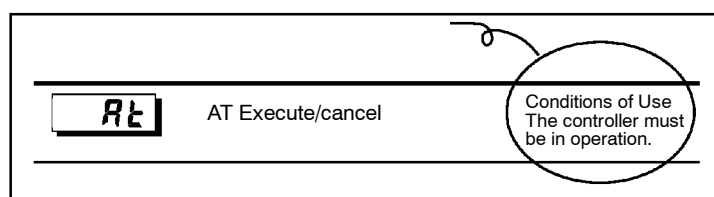

■ About the Order in Which Parameters Described in This Chapter

Parameters are described mode by mode

The first page of each mode lists the parameters available in that mode. The parameter names in these contents are listed in the order that they are displayed on the controller.

Protect Mode

- The protect function restricts key use to prevent unwanted key operation. Before changing parameters in this mode, first make sure that protecting the keys will not cause any problems in operation.
- To select this mode, press the **RUN/RST** and **↺** keys simultaneously for 1 second minimum. To exit this mode, press the **RUN/RST** and **↺** keys simultaneously again for 1 second minimum.
- The following table shows the parameters supported in this mode and the page where the parameter is described.

Symbol	Parameter Name	Page
SECr	Security	5-3
PEyP	Key protect	5-4

SECr Security



Function

- This parameter specifies which parameters are protected. Note that the protect mode and manual mode cannot be protected.



Setting

- Only the modes indicated by the “●” mark in the table below can be selected on the menu display. For example, when this parameter is set to “3”, only levels 0 and 1 and the program mode can be selected.

Mode	Setting value						
	0	1	2	3	4	5	6
Calibration	●						
Option	●	●					
Expansion	●	●					
Setup	●	●					
Level 2	●	●	●				
Level 1	●	●	●	●			
Program	●	●	●	●	●		
Level 0	●	●	●	●	●	●	*1

*1 The “PV/Present SP” parameter is only displayed.

- When this parameter is set to “0”, the protection function is disabled.
- When this parameter is set to “5”, only the parameters in the level 0 mode can be used, and the menu display is not selected.
- When this parameter is set to “6”, “PV/Present SP” parameter can only be displayed. (The set point cannot be changed.)
- Default is “1”. (Only the calibration mode is protected.)



See

- Related description
3.6 Protect Mode (page 3-19)

Protect Mode



Key protect



Function

- Disables key operation of the RUN/RESET or AUTO/MANUAL. For example, if AUTO/MANUAL key operation is disabled (by simultaneously pressing the and keys) in the “key protect” parameter (protect mode) during automatic operation, manual operation is no longer possible.



Setting

- The following table shows the relationship between set values and protected keys.







Set value	Description
1	No keys are protected.
2	AUTO/MANUAL key operation cannot be selected.
3	key cannot be selected.
4	Both the AUTO/MANUAL and RUN/RESET key operations cannot be selected.

- Default is “0” (all keys can be operated).



See





- Related description
3.6 Protect Mode (page 3-19)

- In this mode, manual operation is possible, and the “MANU” LED lights.
- When this mode is selected, the manipulated variable that was active immediately before the mode was switched to is output. To change the manipulated variable, use the  or  keys. If this mode is switched to during auto-tuning, auto-tuning is canceled.
- To select this mode when in the level 0 to 2 modes, press the  and  keys simultaneously for 1 second minimum. To exit this mode, press the  and  keys simultaneously again for 1 second minimum. The mode changes to the level 0 mode.
- “Manual MV” is the only parameter available in this mode.

Manual MV



Function

- Sets the manipulated variable or the valve opening for manual operation. On a standard type controller, when you press the  or  keys, the manipulated variable is changed. On a position-proportional type controller, when you press the  key, the open side becomes ON, and when you press the  key, the close side becomes ON.
- On standard type controllers, the process value is displayed on the No.1 display and the manipulated variable is displayed on the No.2 display.
- On position-proportional controllers, the process value is displayed on the No.1 display, and the valve opening is displayed on the No.2 display when the potentiometer is connected.
- On standard type controllers, the manual MV is held when the power is interrupted.



Setting

- Standard type

Control Method	Setting Range	Unit	Default
Standard	-5.0 to 105.0	%	0.0
Heating and cooling	-105.0 to 105.0	%	0.0

- Position-proportional type





Control Method	Monitor Range	Unit
Position-proportional	-10.0 to 110.0	%









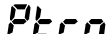
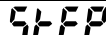
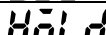

See

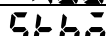
- Related description
3.8 Adjusting Control Operation/Manual operation (page 3-22)

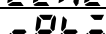
Level 0 Mode

- The parameters in this mode can be used only when the “security” parameter (protect mode) is set to “0” to “5”. Only the “PV/Present SP” parameter can be used when the “security” parameter is set to “6”.
- The parameters in this mode comprise step operation parameters and parameters required for monitoring program operating states.
- To select this mode, press the  key for 1 second minimum. The display changes to the menu display. If you select [L u - 0] then press the  key for 1 second minimum, the controller enters the level 0 mode.
- To select parameters in this mode, press the  key. To change parameter settings, use the  or  keys.
- The following table shows the parameters supported in the level 0 mode and the page where the parameter is described.

Symbol	Parameter Name	Page
	PV/Present SP	5-6
	Pattern No.	5-7
	Step No. monitor	5-7
	Hold	5-8
	Advance	5-8
	Standby time monitor	5-9
	Pattern elapsing time	5-9
	Pattern execution count monitor	5-9
	MV monitor (heat)	5-10
	MV monitor (cool)	5-10
	Valve opening monitor	5-10

PV/Present SP



Function

- The process value is displayed on the No.1 display, and the Present SP is displayed on the No.2 display.
- The decimal point position is dependent on the selected sensor during temperatures input and on the results of scaling during analog input.



Monitor

	Monitor Range	Unit
Process Value	Scaling lower limit -10%FS to scaling upper limit +10%FS	EU
Present SP	Set point lower limit to set point upper limit	EU

- During temperature input, the range of the currently selected sensor is taken as the PV monitor range.



See

- Related parameters
 “Input type” “Scaling upper limit” “Scaling lower limit” “Decimal point” (setup mode)
 “Set point upper limit” “Set point lower limit” (expansion mode)

Plrn

Pattern No.



Function

- This parameter can be set only when the controller is reset.
- Displays the execution pattern during program operation, and the set pattern after the controller is reset.
- This parameter can also be used in the program mode.



Setting

Setting Range	Unit	Default
0 to 7	None	0



See

- Related description
3.5 Setting Patterns (page 3-14)
- Related parameters
All parameters in the program mode

STEP

Step No. monitor



Function

- Monitors the current step No. (This parameter is reset to “0” when the controller is reset.)



Monitor

Monitor Range	Unit
0 to Number of steps-1	None



See

- Related description
4.4 Program Operation (page 4-13)
- Related parameters
“Hold” “Advance” (level 0 mode)

Level 0 Mode

Hold Hold



Function

- This parameter can only be used for monitoring when the controller is reset.
- Pauses (holds) or cancels program operation.
- When the event input to which “Hold/Hold cancel” is assigned is ON, “ $\bar{0}n$ ” (Hold) is displayed, and when “ $\bar{0}FF$: OFF” (Hold cancel) is displayed.
- In addition to the setting of this parameter, hold is canceled by the following conditions:



Setting

Setting Range	Default
$\bar{0}FF$: Hold cancel / $\bar{0}n$: Hold	$\bar{0}FF$



See

- Related description
 - 4.4 Program Operation (page 4-13)
 - 4.8 How to Use Event Input (page 4-21)
- Related parameters
 - “Event input assignment 1 to 4” (option mode)

Adv Advance



Function

- This parameter can only be used for monitoring when the controller is reset.
- Forcibly advances program operation by one step.
- When the event input to which “Hold/Hold cancel” is assigned is ON, “ $\bar{0}n$ ” (Advance) is displayed.



Example of use

- Selecting this parameter, it is set to “ $\bar{0}FF$: OFF”.
- When “ $\bar{0}n$: ON” is selected, program operation is advanced by one step.
- After program execution is completed, the setting automatically returns to “ $\bar{0}FF$ ”.
- Hold is also continued after the program step is advanced when the program is executed in a hold state.



See

- Related description
 - 4.4 Program Operation (page 4-13)
 - 4.8 How to Use Event Input (page 4-21)
- Related parameters
 - “Event input assignment 1 to 4” (option mode)

Stbā

Standby time monitor

Conditions of Use

The controller must be in a standby state.



Function

- Displays the remaining standby time. (This time is not displayed when the controller is reset.)



Monitor

Monitor Range	Unit
0.00 to 99.59	Hour, minute



See

- Related description
4.7 Setting Running Conditions (page 4-19)
- Related parameter
“Standby time” (level 2 mode)

ElāE

Pattern elapsing time



Function

- Displays the time that has elapsed since the start of the pattern. When a pattern is repeatedly executed or all patterns are executed, the time counting restarts at the top of each pattern.



Monitor

Monitor Range	Unit
0.00 to 99.59	Program time unit

When the time exceeds “99.59”, “99.59” blinks on the display.

rPlā

Pattern execution count monitor



Function

- Displays the number of times that the current pattern has been executed. “0” is displayed when the controller is reset or when the controller is in a standby state.



Monitor

Monitor Range	Unit
0 to pattern execution count	Times



See

- Related parameter
“Pattern execution count” (program mode)

Level 0 Mode



MV monitor (heat)

Conditions of Use

The control must be standard control or heating and cooling control.



MV monitor (cool)



Function

- This parameter cannot be set.
- Monitors the manipulated variable on the heating or cooling side.
- The manipulated variable in a standard control system is monitored in the “MV monitor (heat)” parameter.
- The “MV monitor (cool)” parameter can be used only during heating and cooling control.



Monitor

- MV monitor (heat)

Control	Monitor Range	Unit
Standard	-5.0 to 105.0	%
Heating and cooling	0.0 to 105.0	%

- MV monitor (cool)

Control	Monitor Range	Unit
Heating and cooling	0.0 to 105.0	%



Model

E5AK-TAA2



Valve opening monitor

Conditions of Use

The control must be position-proportional control.



Function

- Monitors the valve opening during position-proportional control.



Monitor

Monitor Range	Unit
-10.0 to +110.0	%

“----” is displayed when a potentiometer is not connected.



See







- Related description
 - 4.1 Selecting the Control Method/Position-proportional control (page 4-3)

















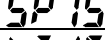

Model

E5AK-TPRR2

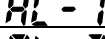
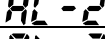
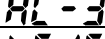
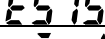
Program Mode

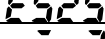
- The parameters in this mode can be used only when the “security” parameter (protect mode) is set to “0” to “4”.
- This mode contains the parameters that you use for programming.
- To select this mode, press the  key for 1 second minimum. The display changes to the menu display. If you select [Prtn] using the  and  keys, and then press the  key for 1 second minimum, the controller enters the program mode.
- To select parameters in this mode, press the  key. To change parameter settings, use the  or  keys.
- The following table shows the parameters supported in this mode and the page where the parameter is described.

Symbol	Parameter Name	Page
	Pattern No.	5-7 *1
	Number of steps	5-12
	Step 0 SP or Target SP 0	5-12
	Ramp rate 0	5-13
	Step 0 time or Soak time 0	5-13
	Step 7 SP or Target SP7	5-12
	Ramp rate 7	5-13
	Step 7 time or Soak time 7	5-13
	Step 8 SP	5-12
	Step 8 time	5-13
	Step 15 SP	5-12
	Step 15 time	5-13
	Pattern execution count	5-14
	Alarm value 1	5-14
	Alarm value 2	5-14
	Alarm value 3	5-14
	Time signal 1 enabled step	5-15
	Time signal 1 ON time	5-15
	Time signal 1 OFF time	5-16
	Time signal 2 enabled step	5-15
	Time signal 2 ON time	5-15
	Time signal 2 OFF time	5-16

*1 This parameter is described as a level 0 mode parameter. For details, see page 5-7.

Program Mode

5-nō

Number of steps



Function

- Specifies the number of steps in the current pattern.



Setting

Setting Range	Unit	Default
1 to 16	None	8



See

- Related description
3.5 Setting Patterns (page 3-14)
- Related parameter
All parameters in the program mode

SP0

Step 0 time (Step time)

Target SP 0 (Rate of rise programming)

to

SP7

Step 7 SP (Step time)

Target SP 7 (Rate of rise programming)

Conditions of Use
Within the number of steps.

SP8

Step 8 SP (Step time)

to

SP15

Step 15 SP (Step time)



Function

- Sets the SP of steps 0 to 15 when the step time is set.
- Sets target SP 0 to 7 when the rate of rise programming is set.
- During temperature input, the decimal point position is dependent on the currently selected sensor, and during analog input on the results of scaling.



Setting

Setting Range	Unit	Default
SP lower limit to SP upper limit	EU	0



See

- Related description
3.5 Setting Patterns (page 3-14)
4.3 Ramp Rise Rate Setup Program (page 4-9)
- Related parameters
All parameters in the program mode
“Input type” “Scaling upper limit” “Scaling lower limit” “Decimal point” (setup mode)
“Step time/Rate of rise programming” (expansion mode)

Program Mode

P-0

Ramp rate 0

to

P-7

Ramp rate 7

Conditions of Use

Within the number of steps only in the rate of rise programming.



Function

- Sets the degree of change per time unit of ramp rate in the step time ramp step.



Setting

Setting Range	Unit	Default
0 to 9999	EU/Time unit of ramp rate	0

0: The ramp step is skipped.



See

- Related description
4.3 Ramp Rise Rate Setup Program (page 4-9)
- Related parameters
All parameters in the program mode
“Step time/Rate of rise programming” “Time unit of ramp rate” (expansion mode)

t-0

Step 0 time (Step time)

Soak time 0 (Rate of rise programming)

to

t-7

Step 7 time (Step time)

Soak time 7 (Rate of rise programming)

t-8

Step 8 time (Step time)

to

t-15

Step 15 time (Step time)

Conditions of Use

Within the number of steps.



Function

- Sets the time of steps 0 to 15 when the step time is set.
- Sets soak steps 0 to 7 when the rate of rise programming is set.



Setting

Setting Range	Unit	Default
0.00 to 99.59	Program time unit	0.00



See

- Related description
3.5 Setting Patterns (page 3-14)
4.3 Ramp Rise Rate Setup Program (page 4-9)
- Related parameters
All parameters in the program mode
“Step time/Rate of rise programming” “Program time unit” “Time unit of ramp rate” (expansion mode)

Program Mode

rPt

Pattern execution count



Function

- Repeatedly executes the current pattern for the preset number of times.
- The count during pattern execution can be monitored in the “pattern execution count monitor” (level 0 mode).



Setting

Setting Range	Unit	Default
0 to 9999	Time	1

0: The pattern is not executed



See

- Related description
4.4 Program Operation/Pattern operation (page 4-13)
- Related parameters
All parameters in the program mode

AL - 1

Alarm value 1

AL - 2

Alarm value 2

AL - 3

Alarm value 3

Conditions of Use

Alarms must be assigned as outputs.
For example, if alarm outputs 1 and 2 only are assigned as outputs, the “alarm value 3” parameter cannot be used.



Function

- This parameter is used for monitoring or setting the alarm values of alarm outputs 1 to 3.
- During temperature input, the decimal point position is dependent on the currently selected sensor, and during analog input on the results of scaling.



Setting

Setting Range	Unit	Default
-1999 to 9999	EU	0



See

- Related description
3.4 Setting Alarm Type (page 3-10)
3.5 Setting Patterns/Alarm value (page 3-16)
- Related parameters
“Input type” “Scaling upper limit” “Scaling lower limit” “Decimal point” “Control output 1 assignment” “Control output 2 assignment” “Auxiliary output 1 assignment” “Auxiliary output 2 assignment” “Alarm 1 type” “Alarm 2 type” “Alarm 3 type” “Alarm 1 open in alarm” “Alarm 2 open in alarm” “Alarm 3 open in alarm” (setup mode)
“Alarm 1 hysteresis” “Alarm 2 hysteresis” “Alarm 3 hysteresis” (level 2 mode)

Program Mode

ts15

Time signal 1 enabled step

Conditions of Use

Each of the time signals must be assigned as outputs.

ts25

Time signal 2 enabled step



Function

- Sets the step in which the time signal is used.



Setting

Setting Range	Unit	Default
0 to 15	None	0



See

- Related description
4.6 Program output (page 4-17)
- Related parameters
“Time signal 1 ON time” “Time signal 1 OFF time” “Time signal 2 ON time”
“Time signal 2 OFF time” (program mode)

on1

Time signal 1 ON time

Conditions of Use

Each of the time signals must be assigned as outputs.

on2

Time signal 2 ON time



Function

- Sets the ON time of the time signal.



Setting

Setting Range	Unit	Default
0.00 to 99.59	*1	0.00

*1 Program time unit



See

- Related description
4.6 Program Output (page 4-17)
- Related parameters
“Time signal 1 enabled step” “Time signal 2 enabled step” “Time signal 1 OFF time” “Time signal 2 OFF time” (program mode)
“Program time unit” (expansion mode)

Program Mode



Time signal 1 OFF time



Time signal 2 OFF time

Conditions of Use
Each of the time signals must be assigned as outputs.



Function

- Sets the OFF time of the time signal.



Setting





Setting Range	Unit	Default
0.00 to 99.59	Program time unit	0.00













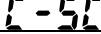

See

- Related description
4.6 Program output (page 4-17)
- Related parameters
“Time signal 1 enabled step” “Time signal 2 enabled step” “Time signal 1 ON time” “Time signal 2 ON time” (program mode)
“Program time unit” (expansion mode)

Level 1 Mode

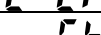
- The parameters in this mode can be used only when the “security” parameter (protect mode) is set to “0” to “3”.
- This mode contains the main parameters for adjusting control, such as executing AT (auto-tuning), setting the control period, setting PID parameters and setting heater burnout (HBA) conditions.
- To select this mode, press the  key for 1 second minimum. The display changes to the menu display. If you select [LW-!] then press the  key for 1 second minimum, the controller enters the level 1 mode.
- To select parameters in this mode, press the  key. To change parameter settings, use the  or  keys.
- The following table shows the parameters supported in this mode and the page where the parameter is described.

Symbol	Parameter Name	Page
	AT Execute/Cancel	5-18
	Proportional band	5-18
	Integral time	5-18
	Derivative time	5-18
	Cooling coefficient	5-19
	Dead band	5-19
	Position-proportional dead band	5-20
	Manual reset value	5-20
	Hysteresis (heat)	5-21
	Hysteresis (cool)	5-21
	Control period (heat)	5-22
	Control period (cool)	5-22
	Heater current monitor	5-23
	Heater burnout	5-23

Level 1 Mode



AT Execute/Cancel

Conditions of Use

The controller must be in operation, and control must be advanced PID control.



Function

- Selects the limit cycle of MV change width (40% or 100%) for execution. After AT execution, the “PID” and the “LBA detection time” (Loop Break Alarm) parameters are automatically set.
- During heating and cooling control or position-proportional control, only 100%AT can be executed.



Example of use

- To execute 40%AT, select [**At** - !], and to execute 100%AT, select [**At** - 2]. During execution of auto-tuning, the AT LED flashes. However, note that during heating and cooling control or position-proportional control, [**At** - !] is not displayed.
- When AT execution ends, the parameter setting automatically returns to [**OFF**].



See

- Related description
3.8 Adjusting Control Operation/AT (page 3-25)
- Related parameters
“Proportional band” “Integral time” “Derivative time” (level 1 mode)
“LBA detection mode” (level 2 mode)



Proportional band

Conditions of Use

The control must be advanced PID control.



Integral time



Derivative time



Function

- Sets the PID parameters. Note that PID is automatically set when AT is executed.



Setting

Parameter	Setting Range	Unit	Default
Proportional band	0.1 to 999.9	%FS	10.0
Integral time	0 to 3999 *1	Second	233
Derivative time	0 to 39999	Second	40

*1: During position-proportional control, the setting range become 1 to 3999 seconds.



See

- Related parameter
“AT Execute/Cancel” (level 1 mode)

C-5C

Cooling coefficient

Conditions of Use

The control must be either heating and cooling control, or advanced PID control.



Function

- In heating and cooling control, P at the cooling side is calculated by the following formula:

$$\text{Cooling side P} = \text{Cooling coefficient} \times P$$



Setting

Setting Range	Unit	Default
0.01 to 99.99	None	1.00



See

- Related description
4.1 Selecting the Control Method/Heating and cooling control (page 4-2)
- Related parameter
“Proportional band” (level 1 mode)



Model

E5AK-TAA2

C-db

Dead band

Conditions of Use

The control system must be heating and cooling control.



Function

- Sets the output dead band width in a heating and cooling control system. A negative setting sets an overlap band.



Setting

Setting Range	Unit	Default
-19.99 to 99.99	%FS	0.00



See

- Related description
4.1 Selecting the Control Method/Heating and cooling control (page 4-2)



Model

E5AK-TAA2

Level 1 Mode



Position-proportional dead band

Conditions of Use

The control must be position-proportional control.



Function

- Sets the output hold width (ON/OFF switching point for open and close output) during position-proportional control.



Setting

Setting Range	Unit	Default
0.1 to 10.0	%	2.0



See

- Related description
4.1 Selecting the Control Method/Position-proportional control (page 4-3)
- Related parameter
“Open/close hysteresis” (level 2 mode)



Model

E5AK-TPRR2



Manual reset value

Conditions of Use

The control must be either standard control or advanced PID control, and the “integral time” parameter must be set to “0”.



Function

- Sets the required manipulated variable to remove offset during stabilization of P or PD control.



Setting

Setting Range	Unit	Default
0.0 to 100.0	%	50.0



Model

E5AK-TAA2

HYS

Hysteresis (heat)

Conditions of Use

The control system must be ON/OFF control.

CHYS

Hysteresis (cool)



Function

- Sets the hysteresis for ensuring stable operation at ON/OFF switching.
- In a standard control system, use the “hysteresis (heat)” parameter. The “hysteresis (cool)” parameter cannot be used.
- In a heating and cooling control system, the hysteresis can be set independently for heating and cooling. Use the “hysteresis (heat)” parameter to set the heating side hysteresis, and use the “hysteresis (cool)” parameter to set the cooling side hysteresis.



Setting

Parameter	Setting Range	Unit	Default
Hysteresis (heat)	0.01 to 99.99	%FS	0.10
Hysteresis (cool)	0.01 to 99.99	%FS	0.10



See

- Related description
4.1 Selecting the Control Method/ON/OFF control (page 4-5)
- Related parameters
“Control output 1 assignment” “Control output 2 assignment” (setup mode)
“PID/ON/OFF” (expansion mode)



Model

E5AK-TAA2

Level 1 Mode

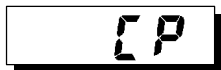

Control period (heat)

Conditions of Use

Relay, SSR or voltage output must set as the outputs, and the control must be set to advanced PID control, standard control or heating and cooling control.

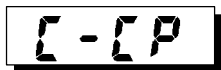

Control period (cool)



Function

- Sets the pulse output period. Set the control period taking the control characteristics and life expectancy of the controller into consideration.
- In a standard control system, use the “control period (heat)” parameter. The “control period (cool)” parameter cannot be used.
- In a heating and cooling control system, the control period can be set independently for heating and cooling. Use the “control period (heat)” parameter to set the heating side control period, and use the “control period (cool)” parameter to set the cooling side control period.



Setting

Parameter	Setting Range	Unit	Default
Control period (heat)	1 to 99	Second	20
Control period (cool)	1 to 99	Second	20



See

- Related description
3.3 Setting Output Specifications (page 3-7)
- Related parameters
“Control output 1 assignment” “Control output 2 assignment” (setup mode)



Model

E5AK-TAA2



Heater current monitor

Conditions of Use

The HBA output function must be assigned as the output.



Function

- Measures the current value of the heater from CT input.
- This parameter is not displayed when the linear output unit (E53-C□, E53-V□) is mounted.



Monitor

Monitor Range	Unit
0.0 to 55.0	A

- [FFFF] is displayed when 55.0 A is exceeded.



See

- Related description
4.9 How to Use the Heater Burnout Alarm (page 4-23)
- Related parameters
“Heater burnout” (level 1 mode)
“HBA latch” (option mode)



Model

E5AK-TAA2



Heater burnout

Conditions of Use

The HBA output function must be assigned as the output



Function

- Outputs the heater burnout alarm when the heater current value falls below this parameter setting.
- When the set value is “0.0”, the heater burnout alarm is “OFF”. When the set value is “50.0”, the heater burnout alarm is “ON”.



Setting

Setting Range	Unit	Default
0.0 to 50.0	A	0.0



See







- Related description
4.9 How to Use the Heater Burnout Alarm (page 4-23)
- Related parameters
“Heater current monitor” (level 1 mode)
“HBA latch” (option mode)



Model

E5AK-TAA2

Level 2 Mode

- The parameters in this mode can be used only when the “security” parameter (protect mode) is set to “0” to “2”.
- This mode contains the auxiliary parameters for adjusting control. These parameters include parameters for limiting the manipulated variable, parameters for switching between remote and local operation, and parameters for setting the LBA (Loop Break Alarm), alarm hysteresis, and input digital filter values.
- To select this mode, press the  key for 1 second minimum. The display changes to the menu display. If you select [L u - 2] pressing the  and  keys, and then press the  key for 1 second minimum, the controller enters the level 2 mode.
- To select parameters in this mode, press the  key. To change parameter settings, use the  or  keys.
- The following table shows the parameters supported in this mode and the page where the parameter is described.

Symbol	Parameter Name	Page
r-l	Remote/Local	5-25
Stb	Standby time	5-25
LbA	LBA detection time	5-26
mv-r	MV at reset	5-26
mv-E	MV at PV error	5-27
ol-H	MV upper limit	5-27
ol-L	MV lower limit	5-27
orL	MV change rate limit	5-27
Inf	Input digital filter	5-28
ol-H	Open/close hysteresis	5-28
ALH1	Alarm 1 hysteresis	5-29
ALH2	Alarm 2 hysteresis	5-29
ALH3	Alarm 3 hysteresis	5-29
InsH	Input shift upper limit	5-29
InsL	Input shift lower limit	5-29



Remote/Local

Conditions of Use

The communications function must be in use.



Function

- Switches between remote and local operation.
- To change the parameter setting during remote operation, use the communications function. To change the parameter setting during local operation, change the setting on the E5AK-T controller. You can check the parameter setting by both communications and on the E5AK-T controller regardless of whether the controller is switched to remote or local operation.
- When the event input to which “remote/local” is assigned is ON, the controller switches to the remote mode. When the event input is OFF, the controller switches to the local mode.



Setting

Setting Range	Default
“r-l”: remote / “L-L”: local	L-L



See

- Related description
Chapter 6 Using the Communications Functions
- Related parameters
“Communication stop bit” “Communication data length” “Communication parity” “Communication baud rate” “Communication unit No.” “Event input assignment 1” “Event input assignment 2” “Event input assignment 3” “Event input assignment 4” (option mode)



Model

- Option units
E53-AK01/02/03



Standby time



Function

- Sets the time until program operation is started after the run instruction is issued.



Setting

Setting Range	Unit	Default
0.00 to 99.59	Hour, minute	0.00



See

- Related description
4.7 Setting Running Conditions/Starting the program run/Standby operation (page 4-20)
- Related parameter
“Standby time monitor” (level 0 mode)

Level 2 Mode

LbA

LBA detection time

Conditions of Use

The LBA (Loop Break Alarm) function must be assigned as an output.



Function

- This parameter is automatically set by AT execution.
- The LBA is output if the change width of the process value falls below 0.2 %full-scale of the time preset to this parameter when the manipulated variable is set in the “MV upper limit” or “MV lower limit” parameters.
- The LBA function is disabled when this parameter is set to “0”.



Setting

Setting Range	Unit	Default
0 to 9999	Second	0



See

- Related description
 - 4.10 LBA (page 4-20)
 - 8.3 How to Use Error Output (page 8-5)
- Related parameters
 - “AT Execute/Cancel” (level 1 mode)
 - “Control output 1 assignment” “Control output 2 assignment” “Auxiliary output 1 assignment” “Auxiliary output 2 assignment” (setup mode)

MV-r

MV at reset

Conditions of Use

Advanced PID control.

MV-E

MV at PV error



Function

- The “MV at reset” parameter sets the manipulated variable when operation has stopped on a standard type controller. On a position-proportional type controller, this parameter sets the action (close/hold/open) when operation has stopped.
- The “MV at PV error” parameter sets the manipulated variable when an input error occurs. On a position-proportional type controller, this parameter sets the action (close/hold/open) when an input error occurs.



Setting

- Standard type

Control Method	Setting Range	Unit	Default
Standard	-5.0 to 105.0	%	0.0
Heating and cooling	-105.0 to 105.0	%	0.0

The manipulated variable at the cooling side during heating and cooling control is expressed as a negative value.

- Position-proportional type

Setting Range	Unit	Default
“Hōld”: Hold/“ōPEŕ”: Open/“CLōS”: Close	None	Hōld



See

- Related description
 - MV at reset : 3.7 Starting and Stopping Operation (page 3-21)
 - MV at PV error : 8.2 How to Use the Error Display (page 8-3)

ōL-H

MV upper limit

Conditions of Use

The control must be advanced PID control.

ōL-L

MV lower limit

ōrL

MV change rate limit



Function

- The “MV upper limit” and “MV lower limit” parameters set the upper and lower limits of the manipulated variable. When the manipulated variable calculated by the E5AK-T controller strays from the upper- and lower-limit range, the upper limit or lower limit set to these parameters is output, respectively. However, note that these parameters are disabled during position-proportional control.
- The “MV change rate limit” parameter sets the maximum permissible change width per second of the manipulated variable (on the position-proportional control, valve opening). If a change in the manipulated variable (on the position-proportional control, valve opening) causes this parameter setting to be exceeded, the calculated value is reached while changing the value by the per-second value set in this parameter.

This function is disabled when the set value is “0.0”.



Setting

- MV upper limit

The setting ranges during standard control and heating and cooling control are different.

Control Method	Setting Range	Unit	Default
Standard	MV lower limit +0.1 to 105.0	%	105.0
Heating and cooling	0.0 to 105.0	%	105.0

The manipulated variable at the cooling side during heating and cooling control is expressed as a negative value.

- MV lower limit

The setting ranges during standard control and heating and cooling control are different.

Control Method	Setting Range	Unit	Default
Standard	-5.0 to MV upper limit -0.1	%	-5.0
Heating and cooling	-105.0 to 0.0	%	-105.0

The manipulated variable at the cooling side during heating and cooling control is expressed as a negative value.

- MV change rate limit

Setting Range	Unit	Default
0.0 to 100.0	%/S	0.0



See

- Related description

4.2 Operating Condition Restrictions/Manipulated variable restrictions (page 4-7)

Level 2 Mode

LnF

Input digital filter



Function

- Sets the time constant of the input digital filter. The following figures shows the effect on data after passing through the digital filter.

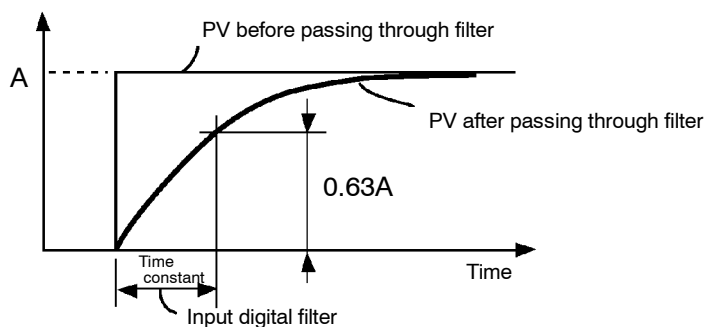

Setting

Setting Range	Unit	Default
0 to 9999	Second	0

oL-H

Open/close hysteresis

Conditions of Use

The control must be position-proportional control.



Function

- Provides hysteresis at ON/OFF switching of open or close output in position-proportional control.



Setting

Setting Range	Unit	Default
0.1 to 20.0	%	0.8



See

- Related description
4.1 Selecting the Control Method/Position-proportional control (page 4-4)



Model

E5AK-TPRR2

ALH1 Alarm 1 hysteresis

ALH2 Alarm 2 hysteresis

ALH3 Alarm 3 hysteresis

Conditions of Use

Alarms must be assigned as output. For example, if alarm outputs 1 and 2 only are assigned as outputs, the “alarm 3 hysteresis” parameter cannot be used.



Function

- Sets the hysteresis of alarm outputs 1 to 3.



Setting

Setting Range	Unit	Default
0.01 to 99.99	%FS	0.02



See

- Related description
3.4 Setting Alarm Type (page 3-10)
- Related parameters
“Alarm 1 type” “Alarm 2 type” “Alarm 3 type” “Alarm 1 open in alarm” “Alarm 2 open in alarm” “Alarm 3 open in alarm” (setup mode)
“Alarm value 1” “Alarm value 2” “Alarm value 3” (Program mode)

LnSH Input shift upper limit

LnSL Input shift lower limit

Conditions of Use

The input type must be set to temperature input (thermocouple or platinum resistance thermometer).



Function

- Sets each of the shift amounts for the input shift upper and lower limit values.



Setting







Setting Range	Unit	Default
-199.9 to 999.9	°C or °F	0.0



See

- Related description
3.2 Setting Input Specifications (page 3-4)
- Related parameter
“Input type” (setup mode)

Setup Mode

- The parameters in this mode can be used only when the “security” parameter (protect mode) is set to “0” and “1”.
- This mode contains the parameters for checking or setting the basic specifications of the E5AK-T controller. These parameters include parameters for specifying the input type, scaling, output assignments, and direct/reverse operation.
- To select this mode, press the  key for 1 second minimum. The display changes to the menu display. If you select [SEt] pressing the  and  keys, and then press the  key for 1 second minimum, the controller enters the setup mode.
- To select parameters in this mode, press the  key. To change parameter settings, use the  or  keys.
- The following table shows the parameters supported in this mode and the page where the parameter is described.

Symbol	Parameter Name	Page
IN-t	Input type	5-31
IN-H	Scaling upper limit	5-32
IN-L	Scaling lower limit	5-32
dP	Decimal point	5-32
d-U	°C/°F selection	5-33
INIt	Parameter initialize	5-33
OUT1	Control output 1 assignment	5-34
OUT2	Control output 2 assignment	5-34
SUB1	Auxiliary output 1 assignment	5-35
SUB2	Auxiliary output 2 assignment	5-35
ALt1	Alarm 1 type	5-36
ALIn	Alarm 1 open in alarm	5-37
ALt2	Alarm 2 type	5-36
AL2n	Alarm 2 open in alarm	5-37
ALt3	Alarm 3 type	5-36
AL3n	Alarm 3 open in alarm	5-37
orEu	Direct/Reverse operation	5-37

Input type

Input type



Function

- Sets the sensor type by the code.



Setting

- Set the code according to the following table. Default is “2 : K1 thermocouple”.

Set value	Input Type		
0	JPt100	-199.9 to 650.0 (°C) / -199.9 to 999.9 (°F)	Platinum resistance thermometer
1	Pt100	-199.9 to 650.0 (°C) / -199.9 to 999.9 (°F)	
2	K1	-200 to 1300 (°C) / -300 to 2300 (°F)	Thermocouple
3	K2	0.0 to 500.0 (°C) / 0.0 to 900.0 (°F)	
4	J1	-100 to 850 (°C) / -100 to 1500 (°F)	
5	J2	0.0 to 400.0 (°C) / 0.0 to 750.0 (°F)	
6	T	-199.9 to 400.0 (°C) / -199.9 to 700.0 (°F)	
7	E	0 to 600 (°C) / 0 to 1100 (°F)	
8	L1	-100 to 850 (°C) / -100 to 1500 (°F)	
9	L2	0.0 to 400.0 (°C) / 0.0 to 750.0 (°F)	
10	U	-199.9 to 400.0 (°C) / -199.9 to 700.0 (°F)	
11	N	-200 to 1300 (°C) / -300 to 2300 (°F)	
12	R	0 to 1700 (°C) / 0 to 3000 (°F)	
13	S	0 to 1700 (°C) / 0 to 3000 (°F)	
14	B	100 to 1800 (°C) / 300 to 3200 (°F)	
15	W	0 to 2300 (°C) / 0 to 4100 (°F)	
16	PLII	0 to 1300 (°C) / 0 to 2300 (°F)	
17	4 to 20mA		Current input
18	0 to 20mA		
19	1 to 5V		Voltage input
20	0 to 5V		
21	0 to 10V		



See

- Related description
3.2 Setting Input Specifications (page 3-4)

- Related parameter

When input type is set to temperature input:

“°C/°F selection” (setup mode)

When input type is set to voltage input or current input:

“Scaling upper limit” “Scaling lower limit” “Decimal point” (setup mode)

Setup Mode

Ln-H

Scaling upper limit

Ln-L

Scaling lower limit

dp

Decimal point

Conditions of Use

The input type must be set to analog input (voltage or current input).



Function

- This parameter can be used when voltage input or current input is selected as the input type.
- When voltage input or current input is selected as the input type, scaling is carried out. Set the scaling upper limit in the “scaling upper limit” parameter and the scaling lower limit in the “scaling lower limit” parameter.
- The “decimal point” parameter specifies the decimal point position of parameters (set point, etc.) whose unit is set to EU (Engineering Unit).



Setting

- Scaling upper limit, Scaling lower limit

Parameter	Setting Range	Unit	Default
Scaling upper limit	Scaling lower limit + 1 to 9999	None	100
Scaling lower limit	-1999 to scaling upper limit - 1	None	0

- Decimal point : Default is “0”.

Set Value	Setting	Example
0	0 digits past decimal point	1234
1	1 digit past decimal point	123.4
2	2 digits past decimal point	12.34
3	3 digits past decimal point	1.234



See

- Related description
3.2 Setting Input Specifications (page 3-4)
- Related parameter
“Input type” (setup mode)

d-U

°C/°F selection

Conditions of Use

The input type must be set to temperature input (thermocouple or platinum resistance thermometer).



Function

- This parameter can be used when thermocouple or platinum resistance thermometer is selected as the input type.
- Set the temperature input unit to either of “°C” or “°F”.



Setting

Setting Range	Default
“ [] ”: °C / “ [] ”: °F	[]



See

- Related description
3.2 Setting Input Specifications (page 3-4)
- Related parameter
“Input type” (setup mode)

init

Parameter initialize



Function

- Returns parameter settings to their factory settings. However, note that the following parameters are not affected by execution of this parameter: “Input type”, “Scaling upper limit”, “Scaling lower limit”, “Decimal point” and “°C/°F selection”



Example of use

- When this parameter is selected, [no] (“no”) is first displayed. To initialize parameters, press the  key to specify [YES] (“yes”).

Setup Mode

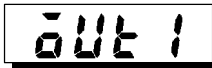

Control output 1 assignment

Conditions of use
The control must be standard control or heating and cooling control.



Control output 2 assignment



Function

- Assigns the output functions to either of control output 1 or 2.
- The following 11 output functions can be assigned as outputs: Control output (heat), Control output (cool), Alarms 1 to 3, HBA, LBA, Time signals 1 and 2, Program end and Stage output
- When the output function assigned to control output 1 or control output 2 is ON, the “OUT1” or “OUT2” LED lights. However, note that the “OUT1” or “OUT2” LEDs do not light if the output unit is E53-C□□ or E53-V□□ when control output (heat) or control output (cool) functions are assigned to control outputs.



Setting

Symbol	<i>HEAT</i>	<i>COOL</i>	<i>AL-1</i> to <i>AL-3</i>	<i>HbA</i>	<i>LbA</i>
Function	Control output (heat)	Control output (cool)	Alarms 1 to 3	HBA	LBA

Symbol	<i>tS-1</i> to <i>tS-2</i>	<i>PEnd</i>	<i>StG</i>
Function	Time signals 1 to 2	Program end	Stage output

Default :

“Control output 1” = [*HEAT*], “Control output 2” = [*AL-1*].



See

- Related description
3.3 Setting Output Specifications (page 3-7)
- Related parameters
 - Alarm-related parameters
 - Heating and cooling related parameter
“Time signal 1 enabled step” “Time signal 2 enabled step” “Time signal 1 to 2 ON time” “Time signal 1 to 2 OFF time” (program mode)
“LBA detection time” (level 2 mode)



Model

E5AK-TAA2

SUB1 Auxiliary output 1 assignment

SUB2 Auxiliary output 2 assignment



Function

- Assigns output functions to either of auxiliary output 1 or 2.
- The following 11 output functions can be assigned as outputs: Alarms 1 to 3, HBA, LBA, Time signals 1 to 2, Program end, Stage output, Error 1 (input error), Error 2 (A/D converter error)
- When the output function assigned to auxiliary output 1 or auxiliary output 2 is ON, the SUB1 or SUB2 LED lights.



Setting

Symbol	<i>AL-1</i> to <i>AL-3</i>	<i>HbA</i>	<i>LbA</i>	<i>tS-1</i> to <i>tS-2</i>
Function	Alarms 1 to 3	HBA	LBA	Time signals 1 to 2

Symbol	<i>PEnd</i>	<i>StG</i>	<i>SErr</i>	<i>E333</i>
Function	Program end	Stage output	Error 1	Error 2

Default :

“Auxiliary output 1” = [*AL-2*], “Auxiliary output 2” = [*AL-3*].



See

- Related description
3.3 Setting Output Specifications (page 3-7)
- Related parameters
- Alarm-related parameters
“Time signal 1 enabled step” “Time signal 2 enabled step” “Time signal 1 to 2 ON time” “Time signal 1 to 2 OFF time” (program mode)
“LBA detection time” (level 2 mode)

Setup Mode

AL1

Alarm 1 type

AL2

Alarm 2 type

AL3

Alarm 3 type

Conditions of Use

Alarms must be assigned as outputs.
For example, if alarm output 1 and 2 only are assigned as outputs, the “alarm 3 type” parameter cannot be used.



Function

- “Alarm 1 to 3 type” parameters specify the operation of the alarm by the one of the set values in the following table. For details of operation at an alarm, see page 3-10.



Setting

Set Value	Settings	Set Value	Settings
1	Upper- and lower-limit alarm	7	Lower-limit alarm with standby sequence
2	Upper-limit alarm	8	Absolute-value upper-limit alarm
3	Lower-limit alarm	9	Absolute-value lower-limit alarm
4	Upper- and lower-limit range alarm	10	Absolute-value upper-limit alarm with standby sequence
5	Upper- and lower-limit alarm with standby sequence	11	Absolute-value lower-limit alarm with standby sequence
6	Upper-limit alarm with standby sequence		

Default is “2 : upper limit”.



See

- Related description
3.4 Setting Alarm Type (page 3-10)
- Related parameters
“Alarm value 1” “Alarm value 2” “Alarm value 3” (Program mode)
“Alarm 1 hysteresis” “Alarm 2 hysteresis” “Alarm 3 hysteresis” (level 2 mode)
“Alarm 1 open in alarm” “Alarm 2 open in alarm” “Alarm 3 open in alarm” “Control output 1 assignment” “Control output 2 assignment” “Auxiliary output 1 assignment” “Auxiliary output 2 assignment” (setup mode)

AL1n Alarm 1 open in alarm

AL2n Alarm 2 open in alarm

AL3n Alarm 3 open in alarm

Conditions of Use
 Alarms must be assigned as outputs.
 For example, if alarm outputs 1 and 2 only are assigned as outputs, the “alarm 3 open in alarm” parameter cannot be used.



Function

- Sets the output states of alarms 1 to 3.
- When the controller is set to “close in alarm,” the status of the alarm output function is output as it is. When set to “open in alarm,” the status of the alarm output function is output inverted. The following table shows the relationship between alarm output functions, alarm output and output LEDs.

	Alarm Output Function	Alarm Output	Output LED
Close in alarm	ON	ON	Lit
	OFF	OFF	Not lit
Open in alarm	ON	OFF	Lit
	OFF	ON	Not lit



Setting

Setting Range	Default
“n - ā” : Close in alarm/ “n - ĩ” : Open in alarm	n - ā



See

- Related description
 3.4 Setting Alarm Type (page 3-10)
- Related parameters
 “Alarm value 1” “Alarm value 2” “Alarm value 3” (level 1 mode)
 “Alarm 1 hysteresis” “Alarm 2 hysteresis” “Alarm 3 hysteresis” (level 2 mode)
 “Alarm 1 open in alarm” “Alarm 2 open in alarm” “Alarm 3 open in alarm” “Control output 1 assignment” “Control output 2 assignment” “Auxiliary output 1 assignment” “Auxiliary output 2 assignment” (setup mode)

ōrEu Direct/Reverse operation



Function

- “Direct operation” (or normal operation) refers to control where the manipulated variable is increased according to the increase in the process value. Alternatively, “reverse operation” refers to control where the manipulated variable is increased according to the decrease in the process value.



Setting







Setting Range	Default
“ōr - r” : Reverse operation/ “ōr - d” : Direct operation	ōr - r



See

- Related description
 3.3 Setting Output Specifications/Direct/reverse operation (page 3-8)

Expansion Mode

- The parameters in this mode can be used only when the “security” parameter (protect mode) is set to “0” and “1”.
- This mode contains the parameters for setting expanded functions. These parameters include parameters for setting the SP setting limiter, selecting advanced PID and ON/OFF control, and setting the program time unit, step time/rate of rise programming, time unit of ramp rate and the automatic return of display mode.
- To select this mode, press the  key for 1 second minimum. The display changes to the menu display. If you select [E_UE] using the  and  keys, and then press the  key for 1 second minimum, the controller enters the expansion mode.
- To select parameters in this mode, press the  key. To change parameter settings, use the  or  keys.
- The following table shows the parameters supported in this mode and the page where the parameter is described.

Symbol	Parameter Name	Page
SL-H	Set point upper limit	5-39
SL-L	Set point lower limit	5-39
EntL	PID/ON/OFF	5-39
P-on	Operation at power ON	5-40
ESEt	End condition	5-40
t-U	Program time unit	5-41
t-Pt	Step time/Rate of rise programming	5-41
PtU	Time unit of ramp rate	5-42
PvSt	PV start	5-42
Wt-b	Wait width	5-43
rPAL	Alarm during ramp step enable	5-43
rUnA	Run all enable	5-43
ALFA	α	5-44
At-G	AT calculated gain	5-44
rEt	Automatic return of display mode	5-45
At-H	AT hysteresis	5-45
LbAb	LBA detection width	5-45

SL-H Set point upper limit

SL-L Set point lower limit



Function

- Limits the upper and lower limits when the SP is set. The SP can be set within the range defined by the upper and lower limit set values of the “set point upper limit” and “set point lower limit ” parameters. Note that as these parameters are reset, the SP of existing settings that are out of the range are forcibly changed to one of the upper or lower limit values.
- When the temperature input type and temperature unit have been changed, the set point upper limit and set point lower limit are forcibly changed to the upper and lower limits of the sensor.
- During temperature input, the decimal point position is dependent on the currently selected sensor, and during analog input on the results of scaling.



Setting

Parameter	Setting Range	Unit	Default
Set point upper limit	Set point lower limit +1 to scaling upper limit	EU	1300
Set point lower limit	Scaling lower limit to set point upper limit -1	EU	-200

During temperature input, the range becomes the range of use of the selected sensor instead of the range defined by the scaling upper and lower limit values.



See

- Related description
4.2 Operating Condition Restrictions (page 4-7)
- Related parameter
“Input type” “Scaling upper limit” “Scaling lower limit” “Decimal point” (setup mode)

ENTL PID/ON/OFF

Conditions of Use

The control must be standard control or heating and cooling control.



Function

- Selects advanced PID control or ON/OFF control.



Setting

Setting Range	Default
“P _{id} ”:Advance PID/“ōnōF”:ON/OFF	P _{id}



See

- Related description
4.1 Selecting the Control Method/ON/OFF control (page 4-5)
- Related parameters
“Hysteresis (heat)” “Hysteresis (cool)” (level 1 mode)



Model

E5AK-TAA2

Expansion Mode

P-on

Operation at power ON



Function

Selects one of the following operations when the power is turned ON:

- “Continue” : Starts operations from the state that was active when the power was interrupted.
- “Reset” : Resets the controller.
- “Run” : Starts normal program operation.
- “Manual” : Sets the controller to the manual mode.

“Manual” cannot be selected when Auto/Manual key operation is protected.



Setting

Setting Range	Default
“ P-on ”:Continue/ “ rSt ”:Reset/ “ rUn ” Run/ “ nMn ”:Manual	P-on



See

- Related description
4.7 Setting Running Conditions/Operation at power ON (page 4-14)

ESEt

End condition



Function

- Specifies a reset state or continued control on the SP of the final step after program operation ends.
- The program end state will not change when the “number of steps” parameter setting has been changed after program operation ends. However, when control on the SP is continued, the SP of the final step is selected after the number of steps has been changed.



Setting

Setting Range	Default
“ rSt ”:Reset/ “ SP ”:Continued control using final SP	rSt



See

- Related description
4.7 Setting Running Conditions/End condition (page 4-15)
- Related parameter
“Number of steps” (program mode)

E-U

Program time unit



Function

- Specifies the time unit of the following parameters:
 “Pattern elapsing time monitor”, “Step 0 to 15 time”/Soak time 0 to 7”, “Time signal 1 ON time” “Time signal 2 ON time” “Time signal 1 OFF time” “Time signal 2 OFF time”



Setting

Setting Range	Default
“HH $\bar{\bar{0}}$ ” :Hour, minute/ “ $\bar{\bar{0}}$ 55” :Minute, second	HH $\bar{\bar{0}}$



See

- Related parameters
 “Pattern elapsing time monitor” (level 1 mode)
 “Steps 0 to 15 time/Soak time 0 to 7” “Time signal 1 ON time” “Time signal 2 ON time” “Time signal 1 OFF time” “Time signal 2 OFF time” (program mode)

E-Pr

Step time/Rate of rise programming



Function

- Specifies the program method.



Setting

Setting Range	Default
“ $\bar{\bar{E}}$ ” :Set time/ “Pr” :Rate of rise programming	$\bar{\bar{E}}$



See

- Related description
 3.5 Setting Patterns (page 3-14)
 4.3 Ramp Rise Rate Setup Program (page 4-9)
- Related parameter
 “Step 0 to 15 SP/Target SP 0 to 7” “Ramp rate 0 to 7” “Step 0 to 15 time/Soak time 0 to 7” (program mode)

Expansion Mode

P-U

Time unit of ramp rate

Conditions of Use

Rate of rise programming must be set.



Function

- Specifies the unit time of “rate of rise 0 to 7.”



Setting

Setting Range	Default
“ \dot{h} ” : Minute/“ H ” : Hour	\dot{h}



See

- Related parameter
“Ramp rate 0 to 7” (program mode)

P-5t

PV start

Conditions of Use

The set time must be set.



Function

Specifies either of the following current SP at the start of program operation:

- PV : Process value at start of program operation (PV start)
- SP : SP of step 0 (normal program operation)

When “PV” is selected, program operation is started from the position where the current SP first matches the PV at the start of program operation. If the SP does not match the PV, program operation is started from the beginning of the program.



Setting

Setting Range	Default
“ P_U ” : PV/“ S_P ” : SP	S_P



See

- Related description
4.7 Setting Running Conditions/Starting the program run/PV start (page 4-20)

4E-6

Wait width



Function

- Specifies the wait width (deviation on SP) during a wait.
- When this parameter is set to “0”, wait is disabled.



Setting

Setting Range	Unit	Default
0 to 9999	EU	0



See

- Related description
4.5 Wait Operation (page 4-16)

rPAL

Alarm during ramp step enable



Function

- To enable alarms during the ramp step, set to [ON]. To disable alarm, set to [OFF].



Setting

Setting Range	Default
“ $\bar{0}n$ ” : / “ $\bar{0}FF$ ”	$\bar{0}n$

rUnA

Run all enable



Function

- To successively execute the program of all patterns from pattern 0, set to [ON].
- Patterns whose “pattern execution count” parameter (level 1 mode) is set to “0” are skipped.

Setting Range	Default
“ $\bar{0}n$ ” : / “ $\bar{0}FF$ ”	$\bar{0}FF$

Expansion Mode

ALFA α

Conditions of Use
The control must be advanced PID control.



Function

- Normally, use the default value.
- Sets advanced PID-control parameter α .



Setting

Setting Range	Unit	Default
0.00 to 1.00	None	0.65

AT-C AT calculated gain

Conditions of Use
The control must be advanced PID control.



Function

- Normally, use the default value.
- Sets the gain when adjusting the PID parameters by auto-tuning.
- To give priority to response, decrease the set value of this parameter. To give priority to stability, increase the set value of this parameter.



Setting

Setting Range	Unit	Default
0.1 to 10.0	None	1.0



See

- Related parameter
“AT Execute/Cancel” (level 1 mode)
“PID/ON/OFF” (expansion mode)
- Related parameter
“PID/ON/OFF” (expansion mode)

Expansion Mode

rEt

Automatic return of display mode



Function

- If you do not operate any of the controller keys for the time set in this parameter when in levels 0 to 2 and program modes, the display automatically returns to the PV/Present SP display.
- When this parameter is set to “0”, this function is disabled. (That is, the display does not automatically return to the PV/Present SP display.)
- This parameter is disabled while the menu display is displayed.



Setting

Setting Range	Unit	Default
0 to 99	Second	0

At-H

AT hysteresis

Conditions of Use

The control must be advanced PID control.



Function

- Normally, use the factory setting.
- The levels of limit cycle operations during AT execution are given hysteresis at event ON/OFF switching. This parameter sets this hysteresis width.



Setting

Setting Range	Unit	Default
0.1 to 9.9	%FS	0.2

LbAb

LBA detection width

Conditions of Use

The LBA (Loop Break Alarm) function must be assigned as an output.



Function







- This parameter can be used when LBA is assigned as an output.
- When the change width of the manipulated variable is below the width set in this parameter, the controller regards this as detection of an LBA.



Setting

Setting Range	Unit	Default
0.0 to 999.9	%FS	0.2

Option Mode

- The parameters in this mode can be used only when the “security” parameter (protect mode) is set to “0” and “1”.
- You can select this mode only on controllers that support optional functions. In this mode, you can set the communications conditions, transfer output and event input parameters to match the type of optional function supported on the controller. This mode also contains the parameters for the heater burnout alarm (HBA) function and position-proportional travel time.
- To select this mode, press the  key for 1 second minimum. The display changes to the menu display. If you select [ōPt] using the  and  keys, and then press the  key for 1 second minimum, the controller enters the option mode.
- To select parameters in this mode, press the  key. To change parameter settings, use the  or  keys.
- The following table shows the parameters supported in this mode and the page where the parameter is described.

Symbol	Parameter Name	Page
<i>Eu-1</i>	Event input assignment 1	5-47
<i>Eu-2</i>	Event input assignment 2	5-47
<i>Eu-3</i>	Event input assignment 3	5-47
<i>Eu-4</i>	Event input assignment 4	5-47
<i>Sbct</i>	Communication stop bit	5-48
<i>LEn</i>	Communication data length	5-48
<i>Prty</i>	Communication parity	5-48
<i>bPS</i>	Communication baud rate	5-48
<i>U-nō</i>	Communication unit No.	5-48
<i>tr-t</i>	Transfer output type	5-49
<i>tr-H</i>	Transfer output upper limit	5-49
<i>tr-L</i>	Transfer output lower limit	5-49
<i>HbL</i>	HBA latch	5-50
<i>CALb</i>	Motor calibration	5-50
<i>nōt</i>	Travel time	5-51
<i>P-db</i>	PV dead band	5-51

E_U-1 Event input assignment 1

E_U-3 Event input assignment 3

E_U-2 Event input assignment 2

E_U-4 Event input assignment 4



Function

- When one E53-AKB unit is mounted, only the “event input assignment 3” and “event input assignment 4” parameters can be used.
- The following functions are assigned as event inputs: “Run/Reset,” “Remote/Local,” “Auto/Manual,” “Hold/hold cancel,” “Advance,” “Pattern select 0 to 2”
- The remote/local function can be used on E53-AK01/02/03 option units.
- Weighting of the remote/local function is as follows:
Pattern select 0 = 2^0 , Pattern select 1 = 2^1 , Pattern select 2 = 2^2
- When event input is used as advance input, program steps are advanced at the rising edge of the event input signal. When event input is used as run/reset input, the program is reset at the rising edge of the event input signal, and the program runs at the following edge.



Setting

Settings	Function
$\bar{n}\bar{o}n$	Event input disabled
$r\bar{s}t$	OFF→ON : Reset /ON→OFF : Run
$r\bar{r}l$	ON : Remote /OFF : Local
$\bar{a}Mn$	ON : Manual /OFF : Auto
$H\bar{o}l d$	ON : Hold /OFF : Hold cancel
$A\bar{d}v$	OFF→ON : Execution
$P\bar{t}n0$ $P\bar{t}n1$ $P\bar{t}n2$	Specified by combination of three event inputs (*1)

*1 The following table shows the relationship between the pattern select signal and the pattern No.

Pattern No.	0	1	2	3	4	5	6	7
Pattern select 0		○		○		○		○
Pattern select 1			○	○			○	○
Pattern select 2					○	○	○	○

- Default is “ $\bar{n}\bar{o}n$ ”.
- Related description
4.8 How to Use Event input (page 4-23)
- Related parameters
“Remote/local” (level 2 mode)
“Hold” “Advance” (level 0 mode)
“Pattern No.” (level 0/program mode)
- Option units
E53-AKB



See



Model

Option Mode

5b2t

Communication stop bit

6P5

Communication baud rate

LEn

Communication data length

U-nō

Communication unit No.

PrtY

Communication parity

Conditions of Use

The communications function must be in use.



Function

- These parameters are enabled when the power is turned ON again.
- These parameters set the communications conditions. Make sure that the stop bit, data length, parity and baud rate of the host computer and the E5AK-T controller are matching.
- When connecting two or more E5AK-T controllers to the host computer, set unit Nos. that will not conflict with the unit Nos. of other controllers.



Setting

- “Communication stop bit” parameter

Setting Range	Unit	Default
1, 2	Bits	2

- “Communication data length” parameter

Setting Range	Unit	Default
7, 8	Bits	7

- “Communication parity” parameter

Setting	Default
“nōnē”: None/ “EυEη”: Even/ “ōdō”: Odd	EυEη

- “Communication baud rate” parameter

Setting Range	Unit	Default
1.2, 2.4, 4.8, 9.6, 19.2	kbps	9.6

- “Communication unit No.” parameter

Setting Range	Unit	Default
0 to 99	None	0



See

- Related description
Chapter 6 Using the Communications Functions
- Related parameter
“Remote/Local” (level 2 mode)



Model

- Option units
E53-AK01/02/03

Er-t

Transfer output type

Er-H

Transfer output upper limit

Er-L

Transfer output lower limit

Conditions of Use

The transfer output function must be in use.



Function

- These parameters set the transfer output conditions.
- The “transfer output type” parameter selects one of the following data items as the transfer output type, and assigns this to transfer output: Present SP, Process value, Manipulated variable (heat) (standard type), Manipulated variable (cool) (during heating and cooling control on a standard type controller), Valve opening (during position-proportional control)
- The “transfer output upper limit” and “transfer output lower limit” parameters are used for scaling of transfer output. The setting range varies according to this output data. Also, a lower limit value larger than the upper limit value may be set.
- Using temperature input, the decimal point position of the present SP or process value is dependent on the currently selected sensor, and using analog input on the results of scaling.
- Set the scaling of the present SP or process value within the sensor input indication range.



Setting

Transfer Output Type	Transfer Output Lower Limit to Transfer Output Upper Limit
“ SP ” Present SP	-1999 to 9999
“ PV ” Process Value	-1999 to 9999
“ Δ ” Manipulated variable (heat)	-5.0% to 105.0% (standard control), 0.0 to 105.0% (heating and cooling control)
“ Δ̄ ” Manipulated variable (cool)	0.0 to 105.0%
“ u-n ” Valve opening	-10.0 to 110.0%

- Default : [**SP**].



See

- Related description
4.11 How to Use Transfer Output (page 4-28)



Model

- Option units
E53-AKF

Option Mode

HbL

HBA latch

Conditions of Use

The HBA output function must be assigned as the output.



Function

- When this parameter is set to ON, the heater burnout alarm is held until either of the following conditions is satisfied:
 - a Set the heater burnout set value to “0.0”.
 - b Reset the controller. (Turn the controller’s power OFF then back ON again.)



Setting

Setting Range	Default
[0 n]: Enabled/[0 F F]: Disabled	0 F F



See

- Related description
 - 4.9 How to Use the Heater Burnout Alarm (page 4-23)
- Related parameters
 - “Control output assignments 1” “Control output assignments 2” “Auxiliary output assignments 1” “Auxiliary output assignments 2” (setup mode)



Model

E5AK-AA2

CaLb

Motor calibration

Conditions of Use

The control must be position-proportion control.



Function

- Executes motor calibration. Be sure to execute this parameter when monitoring the valve opening. (Displays cannot be switched while motor calibration is being executed.)
- The “travel time” parameter is also reset when this parameter is executed.



Example of use

- Default : [0 F F].
- Motor calibration is executed when [0 n] is selected.
- After motor calibration is completed, the setting automatically returns to [0 F F].
- When an error occurs during motor calibration, [E r r] is displayed on the No.2 display.



See

- Related description
 - 4.1 Selecting the Control Method/Position-proportional control (page 4-4)
- Related parameter
 - “Travel time” (option mode)



Model

E5AK-TPRR2

not

Travel time

Conditions of Use

The control must be position-proportion control.



Function

- Sets the time from valve fully opened to valve fully closed.
- The travel time is automatically set when the “motor calibration” parameter is executed.



Setting

Setting Range	Unit	Default
1 to 999	Second	30



See

- Related description
4.1 Selecting the Control Method/Position-proportional control (page 4-4)
- Related parameters
“Motor calibration” (option mode)



Model

E5AK-TPRR2

P-db

PV dead band

Conditions of Use

The control must be position-proportion control.



Function

- Sets a band centered at SP within which valve will not move.

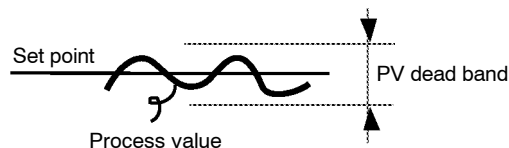

- This function is for special applications, and normally it need not be used. For details, contact your nearest branch of OMRON.
- The decimal is dependent on the results of scaling.



Setting

Setting Range	Unit	Default
0 to 9999	EU	0



See





- Related parameters
“Input type” “Scaling upper limit” “Scaling lower limit” “Decimal point” (setup mode)



Model

E5AK-TPRR2

Calibration Mode

- The parameters in this mode can be used only when the “security” parameter (protect mode) is set to “0”. When selecting this mode for the first time after the E5AK-T has left the factory, return the “security” parameter to “0”.
- This mode contains the parameters for user calibration of inputs and outputs. Only parameters relating to input types specified in the “input type” parameter (setup mode) can be used. Also, related output parameters can be used only when the communications unit (E53-AKF) is added on.
- To select this mode, press the  key for 1 second minimum. The display changes to the menu display. If you select [f t b] using the  and  keys, and then press the  key for 1 second minimum, the controller enters the calibration mode.
- For details on parameters in the calibration mode, see Chapter 7 Calibration.

K CHAPTER 6

USING THE COMMUNICATIONS FUNCTION

This chapter mainly describes communications with a host computer and communications commands.

6.1	Outline of the Communications Function .	6-2
	Outline	6-2
	Transfer procedure	6-2
	Interface	6-2
6.2	Preparing for Communications	6-3
	Cable connections	6-3
	Setting the communications specifications	6-4
6.3	Command Structure	6-5
6.4	Commands and Responses	6-7
	Reading/writing parameters	6-7
	Issuing special commands	6-10
	Reading/writing program parameters	6-12
6.5	How to Read Communications	
	Error Information	6-15
	End code	6-15
	Undefined error	6-16
6.6	Program Example	6-17
	How to use programs	6-17
	Program list	6-18
	Examples of use	6-19

6.1 Outline of the Communications Function

■ Outline

The communications function allows you to monitor and set E5AK-T parameters by a program prepared and running on a host computer connected to the E5AK-T controller. This chapter describes operations as viewed from the host computer.

When the communications function is used, the E53-AK01/02/03 communications unit must be added on.

The E5AK-T communications function allows you to carry out the following:

- Read/write parameters
- Instruct operations
- Select the setting level.

The communications function assumes the following conditions:

- Writing of parameters is possible only during remote operation. Also, parameters cannot be written during execution of auto-tuning.
- Writing of parameters is limited by setting level. Writing conditions are as follows depending on the setting level:
 - Setting level 1: No restrictions
 - Setting level 0: Writing of parameters in the setup, expansion and option modes only is prohibited.
- The “remote/local”, “AT execute/cancel”, “hold/hold cancel” and “advance” parameters are set aside from other parameters as special commands for instructing operations.

■ Transfer procedure

The host computer sends a “command frame” to the controller, and the controller returns a “response frame” corresponding to the content of the command sent by the host computer. In other words, a response frame is returned for each command frame sent.

The following diagram shows command frame/response frame operations.

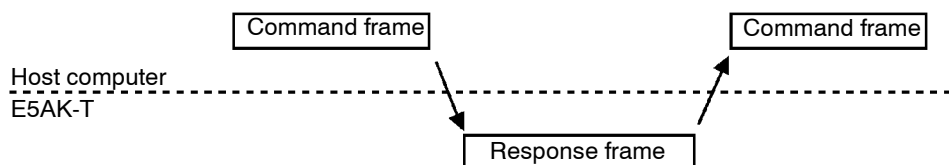

■ Interface

The host computer carries out communications conforming to the RS-232C, RS-422 or RS-485 interface specifications.

Controllers supporting the RS-232C, RS-422 and RS-485 specifications are as follows:

- Option units
 - E53-AK01: RS-232C
 - E53-AK02: RS-422
 - E53-AK03: RS-485

6.2 Preparing for Communications

For details on wiring when the communications function is used, see Chapter 2 Preparations.

■ Cable connections

● RS-232C

- Only one controller can be connected to the host computer. (1:1 connection)
- The cable length should not exceed 15 meters.
- Use shielded twisted-pair cables (AWG28 or more) for the cables.

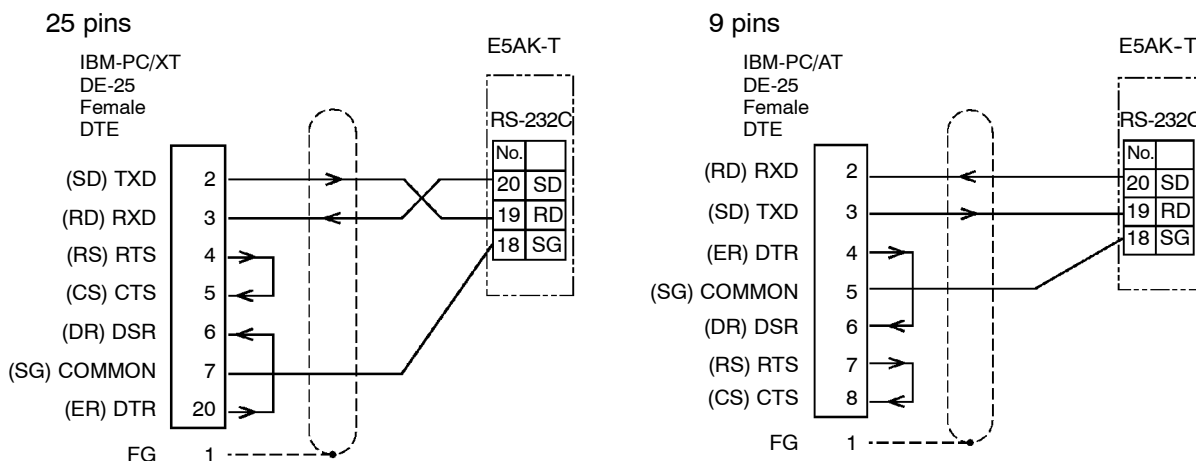

● RS-422

- 1:1 or 1:N connections are allowed. In a 1:N connection, up to 32 controllers including the host computer can be connected.
- The total cable length should not exceed 500 meters.
- Use shielded twisted-pair cables (AWG28 or more) for the cables.
- Attach terminators to the controllers at both ends of the series of controllers connected in an open configuration. For example, in the following configuration, connect the terminator to unit No.30, and do not connect terminators to unit Nos.0 to 29.
- Use terminators having a resistance of 240 Ω (1/2 W). The total resistance of both ends should be at least 100 Ω

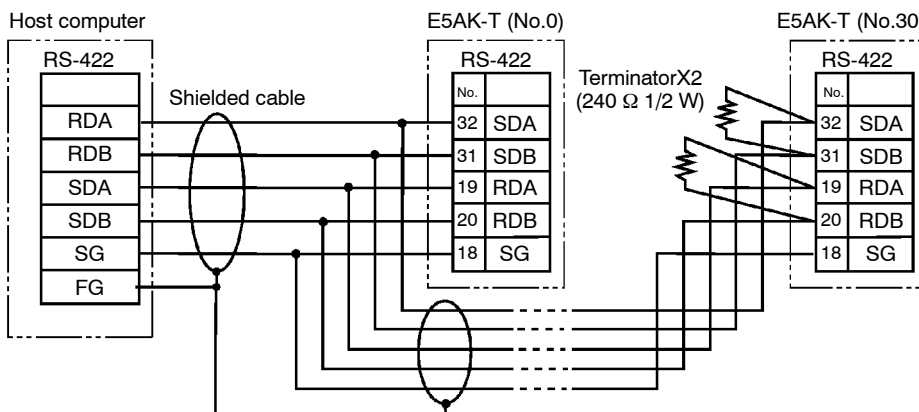

● **RS-485**

- 1:1 or 1:N connections are allowed. In a 1:N connection, up to 32 controllers including the host computer can be connected.
- The total cable length should not exceed 500 meters.
- Use shielded twisted-pair cables (AWG28 or more) for the cables.
- Attach terminators to the controllers at both ends of the series of controllers connected in an open configuration. For example, in the following configuration, connect the terminator to unit No.30, and do not connect terminators to unit Nos.0 to 29.
- Use terminators having a resistance of 120 Ω (1/2 W). The total resistance of both ends should be at least 54 Ω

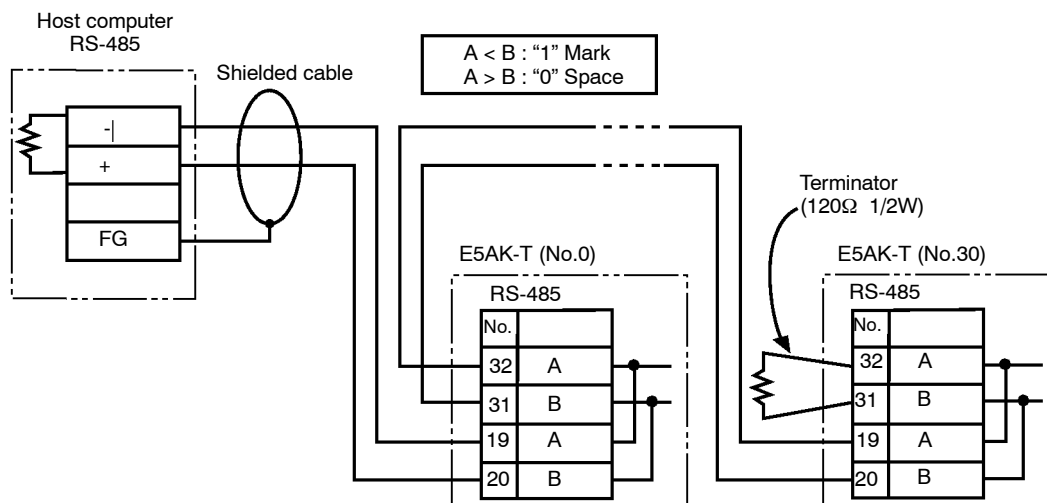

■ **Setting the communications specifications**

Match the communications specifications of the host computer and E5AK-T controller. When two or more controllers are connected to the host computer, make sure that the communications specifications of all controllers are the same.

This section describes how to set the communications specifications for the E5AK-T controller. For details on the host computer, see the relevant manual supplied with the host computer.

● **Communications parameters**

Set the communications specifications of the E5AK-T in the controller's communications parameters. The communications parameters are set on the front panel of the E5AK-T controller.

The following table shows the communications parameters (option mode) provided on the E5AK-T controller and their respective settings.

Parameter/Symbol	Setting	Set Value
Unit No.	<i>U - nō</i>	0 to 99
Baud rate	<i>bPS</i>	1.2/2.4/4.8/9.6/19.2 (kbps)
Bit length	<i>LEN</i>	7/8 (bit)
Parity	<i>Prty</i>	None/even/odd
Stop bit	<i>Stbt</i>	1/2

Inverted items are factory settings.

6.3 Command Structure

Command structure is as follows. Each command is paired with a response.

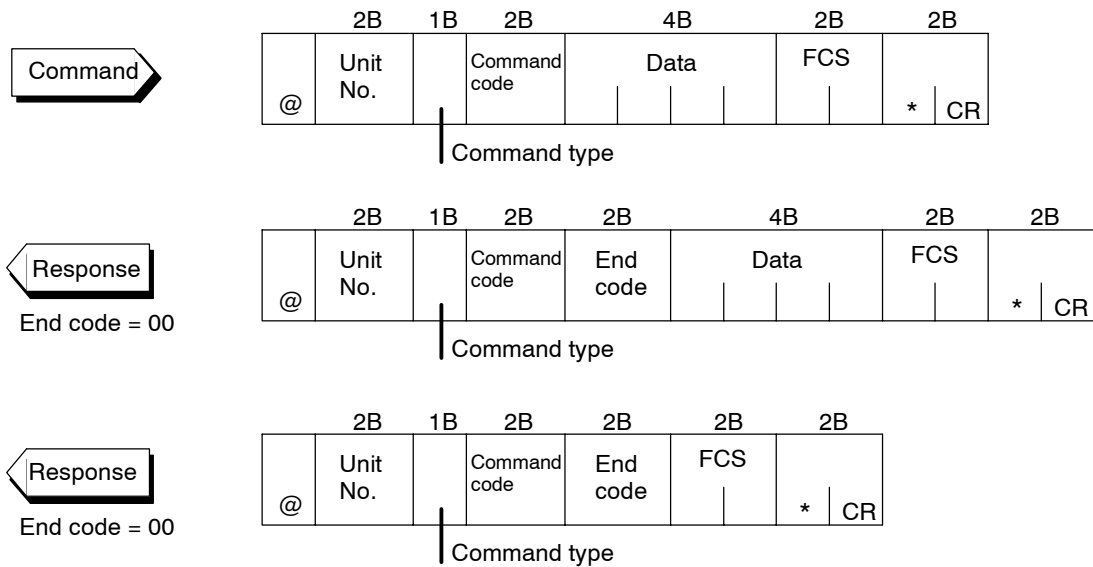

- “@”
The start character. This character must be inserted before the leading byte.
- Unit No.
Specifies the “unit No.” of the E5AK-T. If there are two or more transmission destinations, specify the desired destination using “unit No.”
- Command type

Code	Command type
1	Parameter read
2	Parameter write
3	Special command
4	Program parameter read
5	Program parameter write

- Command code
Specifies the command for each command type. With parameter read/write commands and program parameter read/write commands, this becomes the parameter No.
- Data
Specifies the set value or setting content. With the parameter read and program parameter read commands, set dummy data “0000”. In the response, this is inserted only when the end code is “00”.



About invalid parameters

Currently, if a command is used for invalid parameters (parameters that do not satisfy the conditions of use in Chapter 5), the “undefined” error (end code: IC) response is returned.

- **End code**
Sets the communication results. For details on the types and meanings of end codes, see 6.5 How to Read Communications Error Information (page 6-12).
- **FCS (Frame Check Sequence)**
Set the frame check results from the start character to the data area. For details on the frame check, see 6.6 Program Example (page 6-18).
- **“*” “CR (Carriage Return) code”**
Indicates the end (terminator) of the command or response block.



How to Calculate FCS

Calculate the exclusive OR from the start character to the data section. The following describes an example of how to calculate the FCS for “@00100000”.

- (1) Convert the ASCII codes of each character to Hexadecimal “40H, 30H, ..., 30H”.
- (2) Calculate the exclusive OR of all characters.
- (3) Convert to ASCII code. (→ “4B”)
- (4) Set the result as FCS.

● ASCII → Hex

ASCII	@	0	0	1	0	0	0	0	0	0
Hex	40H	30H	30H	31H	30H	30H	30H	30H	30H	30H

● Exclusive OR

$$40H \oplus 30H \oplus 30H \oplus 31H \oplus 30H \oplus 30H \oplus 30H \oplus 30H \oplus 30H \oplus 30H \oplus 30H = 71H$$

● Conversion to ASCII code at each digit of the calculation result and setting to FCS

ASCII	@	0	0	1	0	0	0	0	0	0	7	1
Hex	40H	30H	30H	31H	30H	30H	30H	30H	30H	30H	37H	31H

FCS

● Completed frame (with appended terminator)

ASCII	@	0	0	1	0	0	0	0	0	0	7	1	*	CR
Hex	40H	30H	30H	31H	30H	30H	30H	30H	30H	30H	37H	31H	2AH	0DH

FCS

Terminator

6.4 Commands and Responses

This section describes commands and response in detail. The conventions used in this section and data restrictions are as follows:

- Data is expressed in 1-byte units and in ASCII code.
- When the read or write data is a numerical value, the data to be set must conform to the following conditions:
 - (1) The decimal point “.” is not indicated in fractions.
 - (2) The leftmost bit of minus numerical data must be expressed as follows:
A: -1, F: - (minus)

[example]

10.0=[0100], -150.0=[A500], -15=[F015]

■ Reading/writing parameters

● Reading parameters

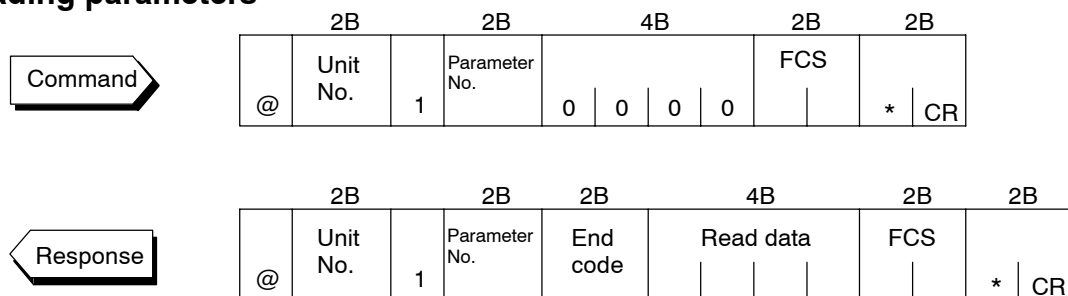

● Writing parameters

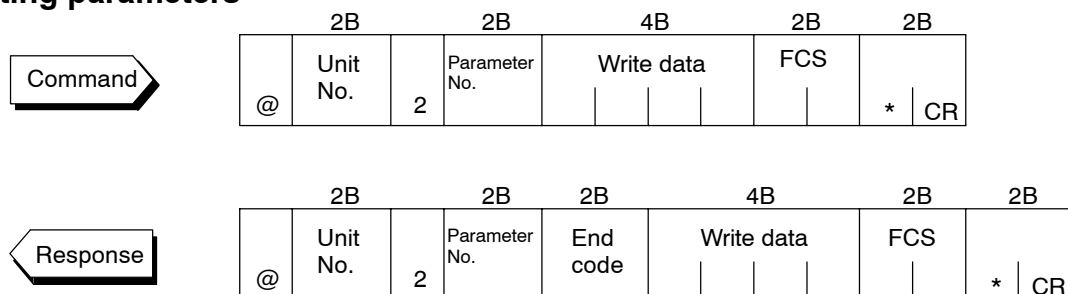

Parameters of a specified controller are read or written.

- Writing is possible only during remote operation.
- Reading is impossible during execution of auto-tuning.
- The following are set aside as special commands. For details, see page 6-10.
 - “Remote/local”, AT execute/cancel”, “Hold/Hold cancel” and “Advance”
- For details on parameters in each setting level, see the tables on page 6-8 and 6-9.

Parameter No.	Parameter	Data Setting and Monitor Range	Mode
00	PV monitor *1 *2	Scaling lower limit -10% to scaling upper limit +10%	Level 0
01	Set point *1	Set point lower limit to set point upper limit	
04	MV monitor (heat) *1	-5.0 to 105.0 *3	
42	MV monitor (cool) *1	0.0 to 105.0	
14	Valve opening monitor *1	-10.0 to 110.0	
02	Alarm value 1	-1999 to 9999	Program
03	Alarm value 2	-1999 to 9999	
41	Alarm value 3	-1999 to 9999	
19	Proportional band	0.1 to 999.9	Level 1
20	Integral time	0 to 3999 *5	
21	Derivative time	0 to 3999	
22	Cooling coefficient	0.01 to 99.99	
09	Dead band	-19.99 to 99.99	
87	Position-proportional dead band	0.1 to 10.0	
23	Manual reset value	0.0 to 100.0	
06	Hysteresis (heat)	0.01 to 99.99	
43	Hysteresis (cool)	0.01 to 99.99	
07	Control period (heat)	1 to 99	
08	Control period (cool)	1 to 99	
17	Heater current monitor *1	0.0 to 55.0	
18	Heater burnout alarm	0.0 to 50.0	
46	LBA detection time	0 to 9999	
47	MV at reset *6	-5.0 to 105.0	
48	MV at PV error *6	-5.0 to 105.0	
50	MV upper limit *3	MV lower limit +0.1 to 105.0	
49	MV lower limit *4	-5.0 to MV upper limit -0.1	
51	MV change rate limit	0.0 to 100.0	
56	Input digital filter	0 to 9999	
88	Open/close hysteresis	0.1 to 20.0	
25	Alarm 1 hysteresis	0.01 to 99.99	
26	Alarm 2 hysteresis	0.01 to 99.99	
52	Alarm 3 hysteresis	0.01 to 99.99	
53	Input shift upper limit	-199.9 to 999.9	
54	Input shift lower limit	-199.9 to 999.9	

*1 Possible only during reading

*2 During temperature input, the range becomes the range of use of the selected sensor.

*3 During heating and cooling control, the range becomes 0.0 to 105.0.

*4 During heating and cooling control, the range becomes -105.0 to 0.0.

*5 During position-proportional control, the range becomes 1 to 3999.

*6 During heating and cooling control, the range becomes -105.0 to 105.0.

During position-proportional control, you can select between 0: Hold/1: Open/2: Close. (Defaults is "0 : Hold".)

Parameter No.	Parameter	Data Setting Range	Mode	
57	Input type	0 to 21 *7	Set up	
59	Scaling upper limit	Scaling lower limit +1 to 9999		
58	Scaling lower limit	-1999 to scaling upper limit -1		
60	Decimal point	0 to 3		
30	°C/°F selection	0: °C, 1: °F		
61	Control output 1 assignment	0 to 6, 10 to 13 *8		
62	Control output 2 assignment	0 to 6, 10 to 13 *8		
63	Auxiliary output 1 assignment	2 to 8, 10 to 13 *8		
64	Auxiliary output 2 assignment	2 to 8, 10 to 13 *8		
65	Alarm 1 type	1 to 11		
66	Alarm 1 open in alarm	0: Closed in alarm, 1: Open in alarm *9		
67	Alarm 2 type	1 to 11		
68	Alarm 2 open in alarm	0: Closed in alarm, 1: Open in alarm *9		
69	Alarm 3 type	1 to 11		
70	Alarm 3 open in alarm	0: Closed in alarm, 1: Open in alarm *9		
71	Direct/Reverse operation	0: Reverse operation, 1: Direct operation		
28	Set point upper limit *1	Set point lower limit +1 to scaling upper limit		Expansion
27	Set point lower limit *1	Scaling lower limit to Set point upper limit -1		
72	PID / ON/OFF	0: Advanced PID, 1: ON/OFF		
35	α	0.00 to 1.00		
85	AT calculated gain	0.1 to 10.0		
36	Automatic return of display mode	0 to 99		
93	AT hysteresis	0.1 to 9.9		
55	LBA detection width	0.0 to 999.9	Option	
77	Event input assignment 3	-1 to 2, 4 to 8 *11		
78	Event input assignment 4	-1 to 2, 4 to 8 *11		
79	Transfer output type	0 to 5 *12		
81	Transfer output upper limit	*12		
80	Transfer output lower limit	*12		
82	HBA latch	0: OFF, 1: ON		
89	Travel time	1 to 999		
38	PV dead band	0 to 9999		

*7 See page 5-31.

*8 0: Control output (heat), 1: Control output (cool), 2 to 4: Alarms 1 to 3, 5: HBA, 6: LBA, 7 and 8: Errors 1 to 2, 10 to 11: Time signal 1 to 2, 12: Program end, 13: Stage output

*9 See page 5-37.

*10 During temperature input, the range becomes the range of use of the selected sensor instead of the scaling upper/lower limit values.

*11 -1: No specification, 0: Run/Reset, 1: Remote/Local, 2: Auto/Manual, 4: Hold/Hold cancel, 5: Advance, 6 to 8: Pattern select 0 to 2

*12 The following table shows the output ranges of the transfer output lower and upper limits.

Transfer Output Type	Transfer Output Lower Limit to Transfer Output Upper Limit
0: Present SP	-1999 to 9999
2: Process value	-1999 to 9999
3: Manipulated variable (heat)	-5.0 to 105.0% (standard control), 0.0 to 105.0% (heating and cooling control)
4: Manipulated variable (cool)	0.0 to 105.0%
5: Valve opening	-10.0 to 110.0%

■ Issuing special commands

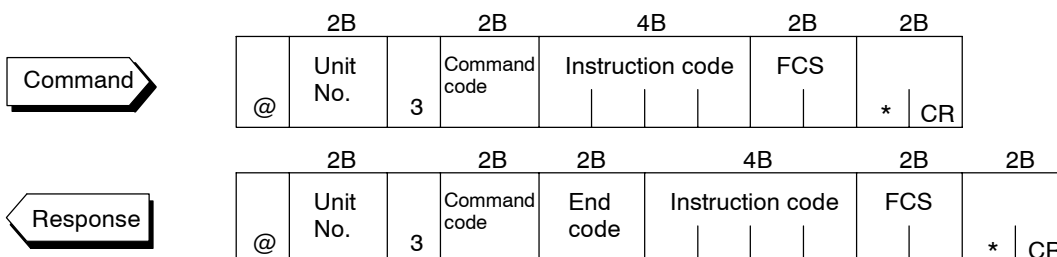

The following functions are issued as special commands.

- **Run/Reset**
Runs or stops programs. This command cannot be issued in setting level 1.
- **Remote/Local (maximum number of writes: 100,000)**
Selects remote operation or local operation.
- **AT Execute/Cancel**
Executes or cancels auto-tuning. This command cannot be issued in setting level 1.
- **Move to setting level 1**
Issue this command when writing parameters in the setup, expansion and option modes. On the E5AK-T, the parameter switches to the top parameter “ $\text{L} \cdot \text{r} \cdot \text{t}$: input type” of the setup mode, and control is stopped.
- **Software reset**
Resets E5AK-T operation (same as turning power ON) by communications. A response is not returned to this command. Also, communications with the E5AK-T cannot be carried out for five seconds after reset.
- **Status**
Monitors the status of the E5AK-T. Two command groups are available, A and B, depending on the instruction code. The response is returned in bit units to the instruction code (4B) of the response frame. For details on the monitoring details of each group, see page 6-11.
- **Hold**
Holds program execution or cancels hold. This command cannot be issued in setting level 1.
- **Advance**
Advances execution of steps in the program. This command cannot be issued in setting level 1.

00	Run/Reset	0000: Run, 0001: Reset
02	Remote/Local	0000: Local, 0001: Remote
07	AT Execute/Cancel	0000: Cancel, 0001: 40% AT execution, 0002: 100% AT execution
09	Move to setting level 1	0000
11	Software reset	0000
14	Status	0000: A group, 0001: B group
15	Hold	0000: Hold cancel, 0001: Hold
16	Advance	0000

In the case of the “Run/Reset” or “Advance” command, issue command when the response of the previous command was returned and passed for 0.5 seconds.

● A group

Bit	Description	[1]	[0]
0	Heating side output *3	ON	OFF *1
1	Cooling side output *4	ON	OFF *1
2	Alarm output 1	ON	OFF *2
3	Alarm output 2	ON	OFF *2
4	Alarm output 3	ON	OFF *2
5	LBA output	ON	OFF *2
6	HBA output	ON	OFF *2
7	Run/Reset	Reset	Run
8	Auto/Manual	Manual	Auto
9	Remote/Local	Remote	Local
10			
11	AT	AT execution	OFF
12	Hold	During hold	OFF
13	Wait	During wait	OFF
14	Event input 3	ON	OFF
15	Event input 4	ON	OFF

● B group

Bit	Description	[1]	[0]
0	Setting level	1	0
1			
2	Control output 1 type	Linear	Pulse
3	Control output 2 type	Linear	Pulse
4			
5	Input error	ON	OFF
6	A/D converter error	ON	OFF
7	CT overflow	ON	OFF
8	CT hold	ON	OFF *5
9	Potentiometer error	ON	OFF
10			
11	Time signal 1 output	ON	OFF *2
12	Time signal 2 output	ON	OFF *2
13	Ramp/soak	Ramp	Soak
14	Program end	ON	OFF *6
15	During standby	ON	OFF

*1 Always "OFF" at linear output

*2 Always "OFF" when output is not assigned

*3 During position-proportional control, output is Open.

*4 During position-proportional control, output is Close.

*5 When the ON time during control output is less than 190 ms, the heater current to which "1" is set and the previous current value is held.

*6 "ON" while the No.2 display indicates [PEnd]. For details on the [PEnd] indication, see page 4-15.

About Setting Levels

To return to setting level 0 from setting level 1, issue the "software reset" command. If the parameter write command is issued for the setup, expansion and option modes in setting level 0, an error occurs, and the end code (0D = Command cannot be executed) is returned.

Reading/writing program parameters

Reading parameters

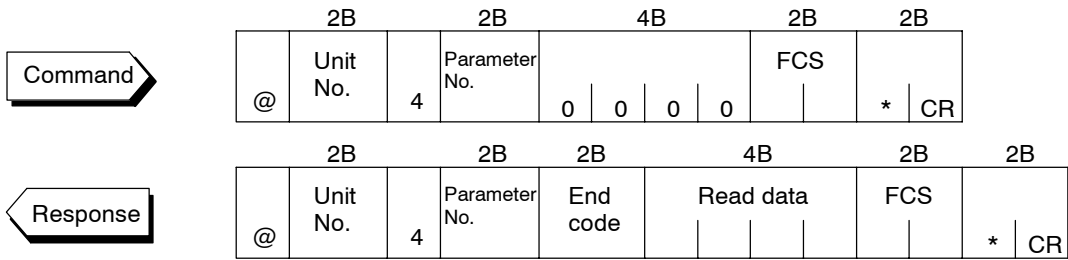

Writing parameters

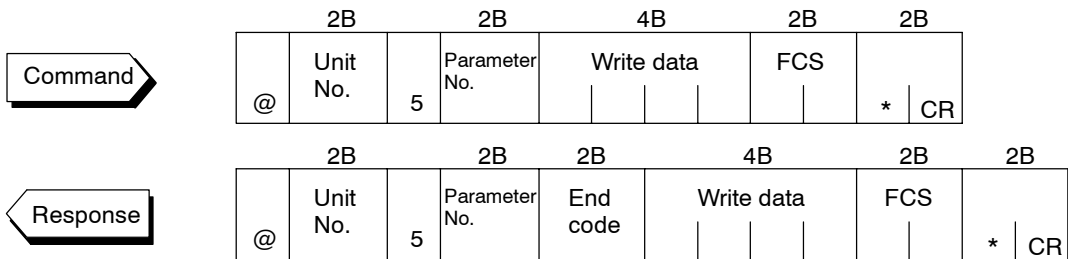

Parameters relating to the program of the specified unit are read or written.

- Writing is possible only during remote operation.
- Reading is impossible during execution of auto-tuning.
- For details on parameters in each setting level, see the lists for each setting level on pages 6-13 to 6-14.

Parameter No.	Parameter	Data Setting and Monitor Range	Mode
00	Pattern No. *2	0 to 7	*2
01	Step No. monitor *1	0 to number of steps -1	Level 0
63	Standby time monitor *1	0.00 to 99.59	
02	Pattern elapsing time monitor *1	0.00 to 99.59	
03	Pattern execution count monitor *1	0 to 9999	
60	Number of steps	1 to 16	Program
05	Step 0 SP/Target SP 0	SP lower limit to SP upper limit	
06	Ramp rate 0	0 to 9999	
07	Step 0 time/Soak time 0	0.00 to 99.59	
08	Step 1 SP/Target SP 1	SP lower limit to SP upper limit	
09	Ramp rate 1	0 to 9999	
10	Step 1 time/Soak time 1	0.00 to 99.59	
11	Step 2 SP/Target SP 2	SP lower limit to SP upper limit	
12	Ramp rate 2	0 to 9999	
13	Step 2 time/Soak time 2	0.00 to 99.59	
14	Step 3 SP/Target SP 3	SP lower limit to SP upper limit	
15	Ramp rate 3	0 to 9999	
16	Step 3 time/Soak time 3	0.00 to 99.59	
17	Step 4 SP/Target SP 4	SP lower limit to SP upper limit	
18	Ramp rate 4	0 to 9999	
19	Step 4 time/Soak time 4	0.00 to 99.59	
20	Step 5 SP/Target SP 5	SP lower limit to SP upper limit	
21	Ramp rate 5	0 to 9999	
22	Step 5 time/Soak time 5	0.00 to 99.59	
23	Step 6 SP/Target SP 6	SP lower limit to SP upper limit	
24	Ramp rate 6	0 to 9999	
25	Step 6 time/Soak time 6	0.00 to 99.59	
26	Step 7 SP/Target SP 7	SP lower limit to SP upper limit	
27	Ramp rate 7	0 to 9999	
28	Step 7 time/Soak time 7	0.00 to 99.59	
29	Step 8 SP	SP lower limit to SP upper limit	
30	Step 8 time	0.00 to 99.59	
31	Step 9 SP	SP lower limit to SP upper limit	
32	Step 9 time	0.00 to 99.59	
33	Step 10 SP	SP lower limit to SP upper limit	
34	Step 10 time	0.00 to 99.59	
35	Step 11 SP	SP lower limit to SP upper limit	
36	Step 11 time	0.00 to 99.59	
37	Step 12 SP	SP lower limit to SP upper limit	
38	Step 12 time	0.00 to 99.59	
39	Step 13 SP	SP lower limit to SP upper limit	
40	Step 13 time	0.00 to 99.59	

*1 Reading only is possible.

*2 Can be used in either the level 0 or program modes.
Read only during program run

Parameter No.	Parameter	Data Setting and Monitor Range	Mode
41	Step 14 SP	SP lower limit to SP upper limit	Program
42	Step 14 time	0.00 to 99.59	
43	Step 15 SP	SP lower limit to SP upper limit	
44	Step 15 time	0.00 to 99.59	
04	Pattern execution count	0 to 9999	
45	Time signal 1 enabled step	0 to 15	
46	Time signal 1 ON time	0.00 to 99.59	
47	Time signal 1 OFF time	0.00 to 99.59	
48	Time signal 2 enabled step	0 to 15	
49	Time signal 2 ON time	0.00 to 99.59	
50	Time signal 2 OFF time	0.00 to 99.59	
62	Standby time	0.00 to 99.59	
54	Operation at power ON	*3	Expansion
55	End condition	0: Reset, 1: Final step SP	
51	Program time unit	0: Hour, minute, 1: Minute, second	
56	Step time/Rate of rise programming	0: Step time, 1: Rate of rise programming	
57	Time unit of ramp rate	0: Minute, 1: Hour	
58	PV start	0: SP start, 1: PV start	
59	Wait width	0 to 9999	
52	Alarm during ramp step enable	0 : OFF, 1 : ON	
53	Run all enable	0 : OFF, 1 : ON	

*3 0: Continue, 1: Reset, 2: Run, 3: Manual

6.5 How to Read Communications Error Information

The result of communications on the E5AK-T can be checked by the end code or undefined error response in the response frame. Use this end code or undefined error response to remedy errors that may occur.

■ End code

Communications are normal when the end code in the response is “00”. If the end code is not “00”, this indicates that an error that is not an undefined error has occurred. The end code format is as follows and does not contain a data area.

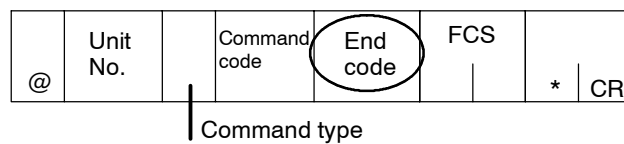

End code	0D	Code name	Command cannot be executed
----------	----	-----------	----------------------------

● Description

- Writing was carried out during local operation.
- Writing was carried out during execution of auto-tuning.
- An attempt was made to execute 40%AT during heating and cooling control or position-proportional control.
- An attempt was made to switch run/reset in setting level 1.
- An attempt was made to execute AT in setting level 1.

● Action

- Issue the parameter read or write commands in conditions other than above.

End code	10	Code name	Parity error
----------	----	-----------	--------------

● Description

Parity check error was detected in the received data.

● Action

Check the communications conditions. If the communications conditions of the host computer and E5AK-T controller match, then a probable cause is a problem in the communications circuit of one or both of the host computer and E5AK-T controller.

End code	11	Code name	Framing error
----------	----	-----------	---------------

● Description

Stop bit cannot be detected.

● Action

Check the communications conditions. If the communications conditions of the host computer and E5AK-T controller match, then a probable cause is a problem in the communications circuit of one or both of the host computer and E5AK-T controller.



About the Unit No.

Responses are not returned unless the target unit for communications and the unit No. defined in the command match.

End code	13	Code name	FCS error
----------	----	-----------	-----------

- **Description** The FCS (Frame Check Sequence) do not match.
- **Action** Check the FCS program.

End code	14	Code name	Format error
----------	----	-----------	--------------

- **Description** The received command length does not match the length defined in the frame format.
- **Action** Check the communications conditions. If the communications conditions of the host computer and E5AK-T controller match, then a probable cause is a problem in the communications circuit of one or both of the host computer and E5AK-T controller.

End code	15	Code name	Setting range error
----------	----	-----------	---------------------

- **Description** Numerical values or code values in the data are not within the setting range.
- **Action** Check the parameter and read or write data of special commands.

■ **Undefined error**

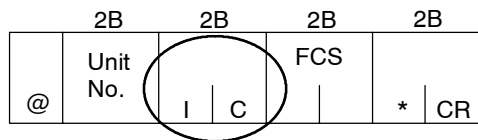

- **Description**
 - An undefined header code has been received.
 - A currently invalid parameter (e.g. the scaling command during temperature input) has been received.
- **Action**
 - Check the parameter No.

6.6 Program Example

■ How to use programs

The program described below obtains corresponding response frame data when some of the command frame data is input.

The input format is as follows. The FCS and terminator are automatically generated, and need not be input.

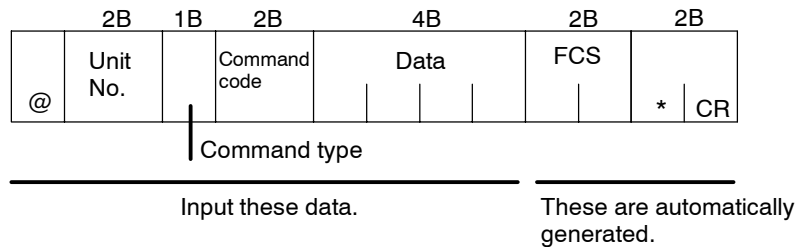

The output format is as follows. The content of the response frame is displayed as it is.

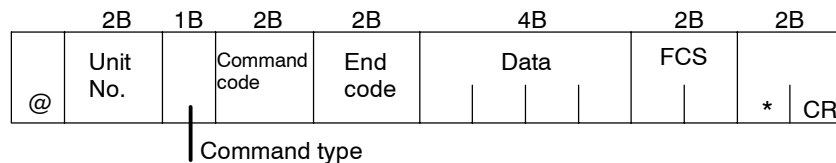

● Procedure

- (1) Read the program.
- (2) Enter "RUN".
- (3) When "send data:" is displayed, enter the command data (from @ to the command string).
- (4) The content of the response frame is displayed following "receive data:".

● Conditions when running a program

- Set the communications conditions as follows:
 - Baud rate : 9600 bps
 - Bit length : 7 bits
 - Parity : Even
 - Stop bit : 2
- Make sure that the communications cable is properly connected.

■ Program list (language: IBM PC Compatible Machine)

```

1000 ' -----
1010 ' PROGRAM : E5AK-T COMMUNICATION PROGRAM
1020 ' ----- FOR IBM PC COMPATBLE MACHINE
1050 ' -----
1060 ' ----- Default RS-232C SPEED: 9600BPS, PARITY: EVEN, DATA: 7, STOP: 2 ---
1070 OPEN "COM: E73" AS #1
1080 *REPEAT
1090 ' -----Enter send data -----
1100 INPUT "send data : ", SEND$
1110' ----- FCS calculation -----
1120 FCS=0
1130 FOR IFCS=1 TO LEN (SEND$)
1140 FCS=FCS XOR ASC (MID$ (SEND$, IFCS, 1))
1150 NEXT
1160 FCS$=RIGHT$ ("0"+HEX$ (FCS), 2)
1170 ' ----- Execute communications -----
1180 ZZZ$=SEND$+FCS$+"*" +CHR$ (13)
1190 PRINT #1, ZZZ$;
1120' ----- Check response -----
1210 RECCNT=0: TMP$=""
1220 *DRECLOOP:
1230 IF LOC (1) < > 0 THEN DREC1
1240 RECCNT=RECCNT+1
1250 IF RECCNT=5000 THEN *DRECERR ELSE DRECLOOP
1260 *DREC1
1270 TMP$=TMP$+INPUT$ (LOC (1), #1)
1280 IF RIGHT$ (TMP$, 1)=CHR$ (13) THEN *DRECEND
      ELSE RECCNT=0: GOTO *DRECLOOP
1290 *DRECERR
1300 TMP$="No response !!" +CHR$ (13)
1310 *DRECEND
1320 RECV$=TMP$
1330 PRINT "receive data : " ; RECV$
1340 ' ----- Repeat to make Command -----
1350' GOTO *REPEAT
1360 ' ----- END -----
1370 CLOSE #1
1380 END

```

Examples of use

- Set the unit No. to “00”.
- In the following examples, data is shown in individual blocks to make the examples easier to understand. However, when actually creating programs, do not leave spaces between frame items. Also, response are displayed without spaces between frame items.

● Set the set point to “300.0”

- Input data

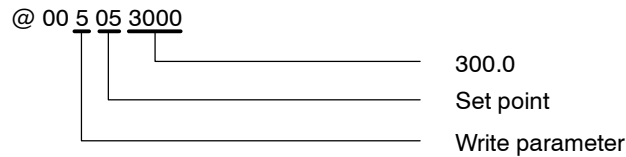

- Response

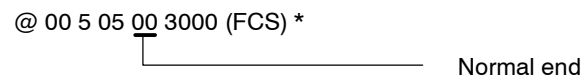

● Start running

- Input data

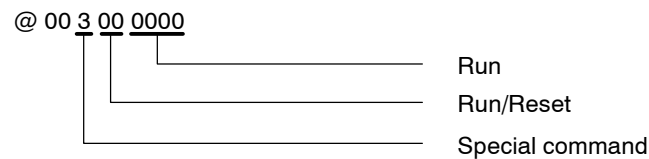

- Response

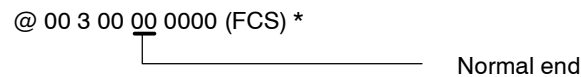

● Monitor process value

- Input data

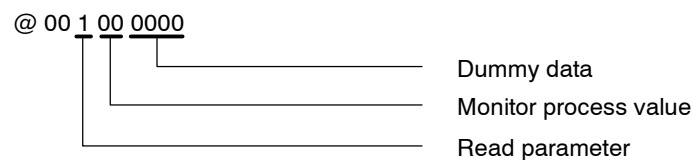

- Response

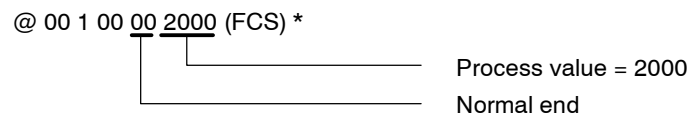

K CHAPTER 7

CALIBRATION

This chapter describes procedures for each calibration operation.
Read this chapter only when the controller must be calibrated.

7.1	Parameter Structure	7-2
7.2	Calibrating Thermocouples	7-4
7.3	Calibrating Platinum Resistance Thermometers	7-7
7.4	Calibrating Current Input	7-9
7.5	Calibrating Voltage Input	7-10
7.6	Checking Indication Accuracy	7-12

7.1 Parameter Structure

- To calibrate the E5AK-T controller, select [**Cal**] in the menu display to select the calibration mode. [**Adj**] is displayed.
- However, note that [**Cal**] may not be displayed on the menu display when, for example, the user is calibrating the E5AK-T controller for the first time. If this happens, [**Cal**] is displayed by changing the “security” parameter (protect mode) to “0”.
- The parameters in the calibration mode are structure as follows:

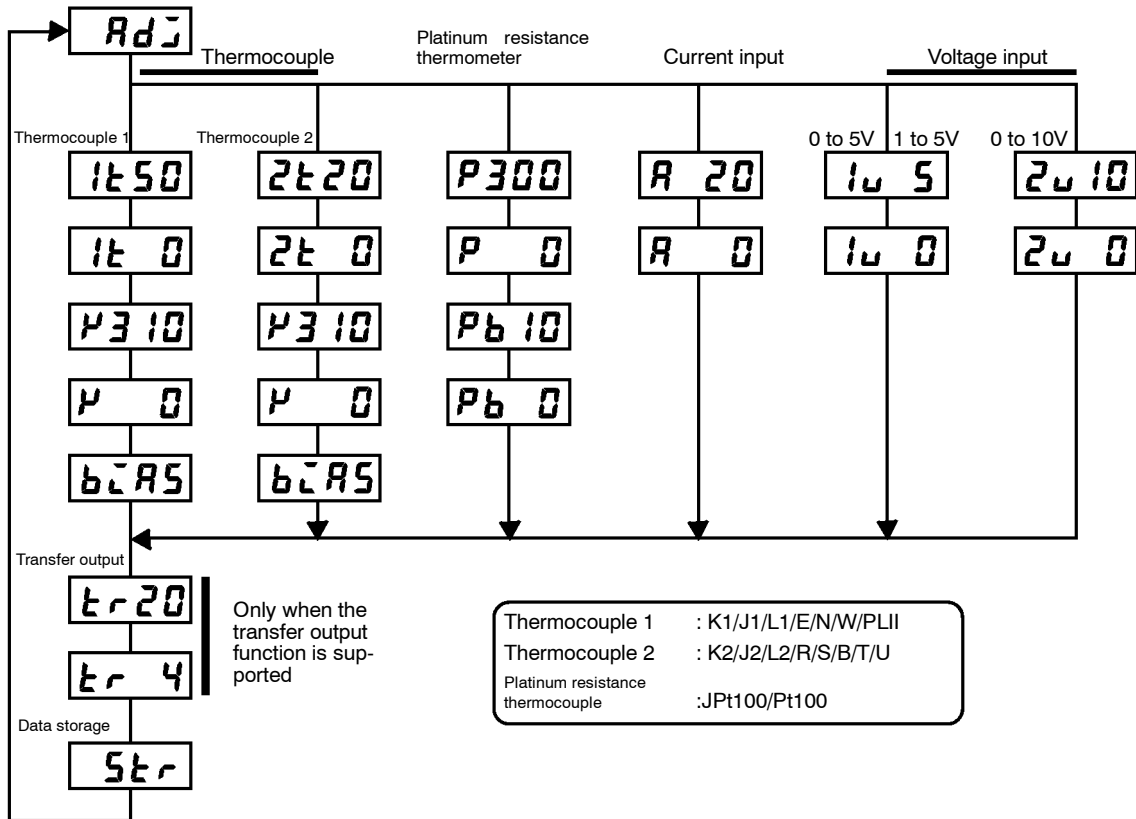

- To select the desired parameter, press the **↻** key. Parameters are displayed in the following order:
 Calibration of inputs → Calibration of transfer output → Storage of calibration data
 If the E5AK-T controller does not support the transfer output function, calibration of transfer output is automatically deleted from the calibration procedure as follows:
 Calibration of inputs → Storage of calibration data
- Only inputs that have been set in the “input type” parameter (setup mode) can be calibrated. To temporarily store data for each of the calibration parameters, press the **⏏** key for 1 second.
- Transfer output can be calibrated only when the Communications unit (E53-AKF) is set in the controller. To adjust data items, press the **⏏** or **⏏** keys.
- The data store menu is displayed only when all calibration items have temporarily been stored.
- After calibrating input, you must always check indication accuracy. For details, see page 7-12.

● Calibration item menu



Calibration item parameter

Process value

- Parameters are displayed on the No.1 display, and the process value is displayed in Hexadecimal on the No.2 display.
- Normally, the process value changes by several digits. The process value flashes, for example, when a sensor error causes the process value to stray from the calibration target range.
- When the process value display is flashing, the process value is not stored as data even if the  key is pressed.

● Calibration store mark



Calibration store mark

- Once the E5AK-T controller has been calibrated by the user, [Adj] is displayed preceded by the “.” mark when the calibration mode is next selected.

7.2 Calibrating Thermocouples

- Calibrate according to the type of thermocouple, thermocouple 1 group (K1, J1, L1, E, N, W, PLII) and thermocouple 2 group (K2, K2, L2, R, S, B, T, U).
- When calibrating, do not cover the bottom of the controller. Also, do not touch the input terminals (Nos.11 and 12) or compensating conductor on the E5AK-T controller.

● Preparations

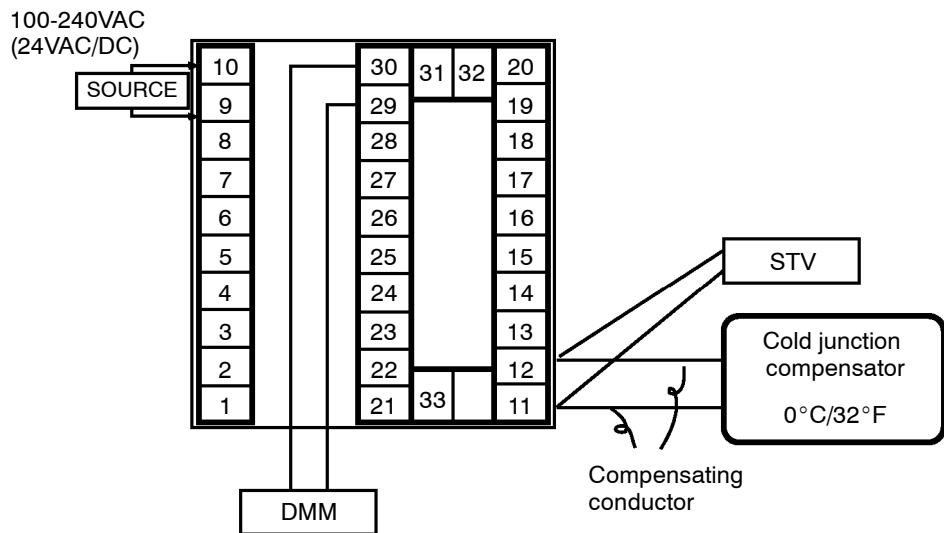

- Set the cold junction compensator designed for compensation of internal thermocouples to 0°C. However, make sure that internal thermocouples are disabled (tips are open).
- In the above figure, STV refers to a standard DC current/voltage source, and DMM refers to a precision digital multimeter. However, note that DMM is required only when the transfer output function is supported.
- Use the compensating conductor on the selected thermocouple. However, note that when thermocouple R, S, E, B, W and PLII is used, the cold junction compensator and the compensating conductor can be substituted with the cold junction compensator and the compensating conductor for thermocouple K.



Connecting the Cold Junction Compensator

Correct process values cannot be obtained if you touch the contact ends of the compensating conductor during calibration of a thermocouple. Accordingly, short (enable) or open (disable) the tip of the thermocouple inside the cold junction compensator as shown in the figure below to create a contact or non-contact state for the cold junction compensator.

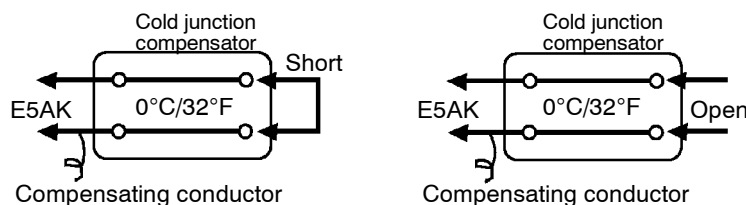

● Calibration: thermocouple 1

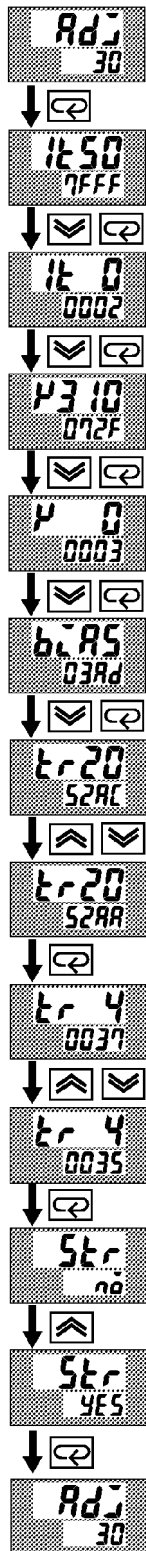

This example describes how to calibrate a thermocouple when the transfer output function is supported. If the transfer output function is not supported, skips steps (7) to (10).

- (1) When [Ad] is displayed, the 30-minute timer is displayed on the No.2 display and counts down. This timer serves as a guide for the aging time when aging is required.
- (2) First, calibrate the main input. Press the key to display [1E 50] (50 mV calibration display). Set STV output to 50 mV. When the value on the No.2 display has stabilized (changes of several digits max.), press the key to temporarily store the calibration data.
- (3) Press the key to display [1E 0] (0 mV calibration display). Set STV output to 0 mV. When the value on the No.2 display has stabilized (changes of several digits max.), press the key to temporarily store the calibration data.
- (4) Next, calibrate the cold junction compensator. Press the key to display [u3 10] (310 mV calibration display). Set STV output to 310 mV. When the value on the No.2 display has stabilized (changes of several digits max.), press the key to temporarily store the calibration data.
- (5) Press the key to display [u 0] (0 mV calibration display). Set STV output to 0 mV. When the value on the No.2 display has stabilized (changes of several digits max.), press the key to temporarily store the calibration data.
- (6) Finally, calibrate the bias compensation value. Disconnect the STV, and enable the thermocouple of the cold junction compensator. When carrying this out, make sure that the wiring on the STV is disconnected. Make sure that the cold junction compensator is set to 0°C and press the key. The display changes to [bC AS] (calibration display for the bias compensation value). When the value on the No.2 display has stabilized (changes of several digits max.), press the key to temporarily store the calibration data.
- (7) Next, calibrate the transfer output function. If the transfer output function is not supported, skip to step (11). Press the key. The display changes to [Er 20] (20 mA calibration display).
- (8) Set the output to 20 mA by the or keys while monitoring the voltage on the digital multimeter. In the example on the left, the display indicates that the value two digits smaller than before calibration is “20 mA”.
- (9) Press the key. The display changes to [Er 4] (4 mA calibration display).
- (10) Set the output to 4 mA by the or keys while monitoring the voltage on the digital multimeter. In the example on the left, the display indicates that the value two digits smaller than before calibration is “4 mA”:
- (11) Press the key until the display changes to the date save display. Press the key. The No.2 display changes to [4E 5], and two seconds later the calibration data is stored to internal memory. If you press the key when the No.2 display reads [n0], the calibration data is disabled.
- (12) This completes calibration of the thermocouple 1 group. Press the key to return the display to [Ad].

● Calibration: thermocouple 2



This example describes how to calibrate a thermocouple when the transfer output function is supported. If the transfer output function is not supported, skips steps (7) to (10).

- (1) When [Adj] is displayed, the 30-minute timer is displayed on the No.2 display and counts down. This timer serves as a guide for the aging time when aging is required.
- (2) First, calibrate the main input. Press the key to display [2t 20] (20 mV calibration display). Set STV output to 20 mV. When the value on the No.2 display has stabilized (changes of several digits max.), press the key to temporarily store the calibration data.
- (3) Press the key to display [2t 0] (0 mV calibration display). Set STV output to 0 mV. When the value on the No.2 display has stabilized (changes of several digits max.), press the key to temporarily store the calibration data.
- (4) Next, calibrate the cold junction compensator. Press the key to display [μ 3 10] (310 mV calibration display). Set STV output to 310 mV. When the value on the No.2 display has stabilized (changes of several digits max.), press the key to temporarily store the calibration data.
- (5) Press the key to display [μ 0] (0 mV calibration display). Set STV output to 0 mV. When the value on the No.2 display has stabilized (changes of several digits max.), press the key to temporarily store the calibration data.
- (6) Finally, calibrate the bias compensation value. Disconnect the STV, and enable the thermocouple of the cold junction compensator. When carrying this out, make sure that the wiring on the STV is disconnected. Make sure that the cold junction compensator is set to 0°C and press the key. The display changes to [b 2 85] (calibration display for the bias compensation value). When the value on the No.2 display has stabilized (changes of several digits max.), press the key to temporarily store the calibration data.
- (7) Next, calibrate the transfer output function. If the transfer output function is not supported, skip to step (11). Press the key. The display changes to [t r 20] (20 mA calibration display).
- (8) Set the output to 20 mA by the or keys while monitoring the voltage on the digital multimeter. In the example on the left, the display indicates that the value two digits smaller than before calibration is “20 mA”.
- (9) Press the key. The display changes to [t r 4] (4 mA calibration display).
- (10) Set the output to 4 mA by the or keys while monitoring the voltage on the digital multimeter. In the example on the left, the display indicates that the value two digits smaller than before calibration is “4 mA”.
- (11) Press the key until the display changes to the data store display. Press the key. The No.2 display changes to [y e 5], and two seconds later the calibration data is stored to internal memory. If you press the key when the No.2 display reads [n 0], the calibration data is disabled.
- (12) This completes calibration of the thermocouple 2 group. Press the key to return the display to [Adj].

7.3 Calibrating Platinum Resistance Thermometers

● Preparation

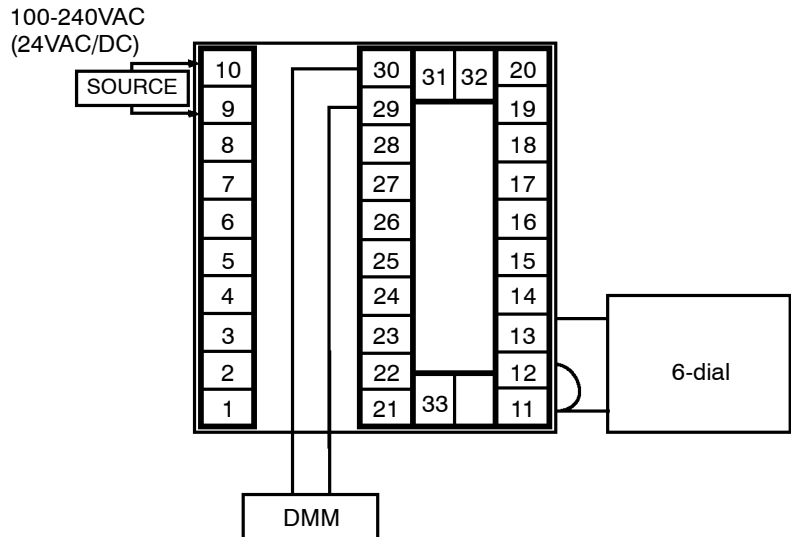

- Use leads of the same thickness when connecting to the platinum resistance thermometer.
- In the above figure, 6-dial refers to a precision resistance box, and DMM stands for a digital multimeter. However, note that the DMM is required only when the transfer output function is supported.
- Connect (short) the leads from terminal Nos.11 and 12.

● Calibration

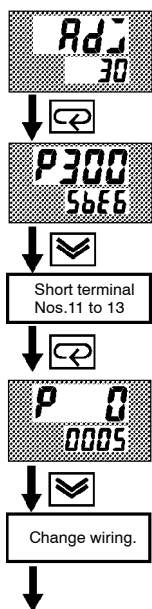

Cont'd on next page

This example describes how to calibrate a platinum resistance thermometer when the transfer output function is supported. If the transfer output function is not supported, skips steps (7) to (10).

- (1) When [R_d] is displayed, the 30-minute timer is displayed on the No.2 display and counts down. This timer serves as a guide for the aging time when aging is required.
- (2) First, calibrate the main input. Press the key to display [$P300$] (300Ω calibration display). Set the 6-dial to 300Ω when the value on the No.2 display has stabilized (changes of several digits max.), press the key to temporarily store the calibration data.
- (3) Press the key to display [$P 0$] (0Ω calibration display). Short terminal No.11 to 13. When the value on the No.2 display has stabilized (changes of several digits max.), press the key to temporarily store the calibration data.
- (4) Next, calibrate the B-B' input. Change the wiring as follows:

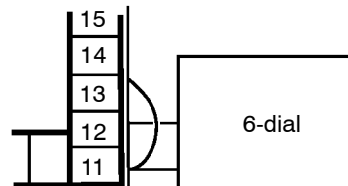

Make the connection across terminal Nos.11 and 12 and the 6-dial as short as possible. Short terminal Nos.11 and 13.

From previous page

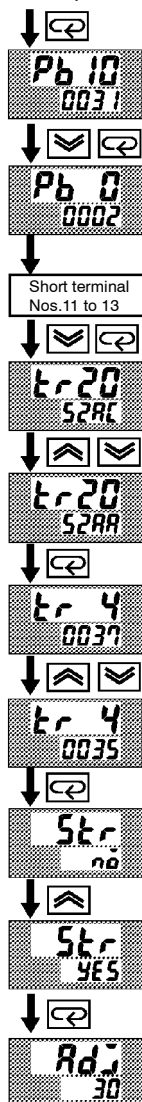

- Press the **[↶]** key to display **[Pb 10]** (10Ω calibration display). Set the 6-dial to 10Ω. When the value on the No.2 display has stabilized (changes of several digits max.), press the **[↵]** key to temporarily store the calibration data.
- Press the **[↶]** key to display **[Pb 0]** (0Ω calibration display). Short terminal Nos.11 to 13. When the value on the No.2 display has stabilized (changes of several digits max.), press the **[↵]** key to temporarily store the calibration data.
- Next, calibrate the transfer output function. If the transfer output function is not supported, skip to step (11). Press the **[↶]** key. The display changes to **[Ir 20]** (20 mA calibration display).
- Set the output to 20 mA by the **[↵]** or **[↶]** keys while monitoring the voltage on the digital multimeter. In the example on the left, the display indicates that the value two digits smaller than before calibration is “20 mA”.
- Press the **[↶]** key. The display changes to **[Ir 4]** (4 mA calibration display).
- Set the output to 4 mA by the **[↵]** or **[↶]** keys while monitoring the voltage on the digital multimeter. In the example on the left, the display indicates that the value two digits smaller than before calibration is “4 mA”.
- Press the **[↶]** key until the display changes to the data store display. Press the **[↶]** key. The No.2 display changes to **[525]**, and two seconds later the calibration data is stored to internal memory. If you press the **[↶]** key when the No.2 display reads **[no]**, the calibration data is disabled.
- This completes calibration of the platinum resistance thermometer. Press the **[↶]** key to return the display to **[Adj]**.

7.4 Calibrating Current Input

● Preparation

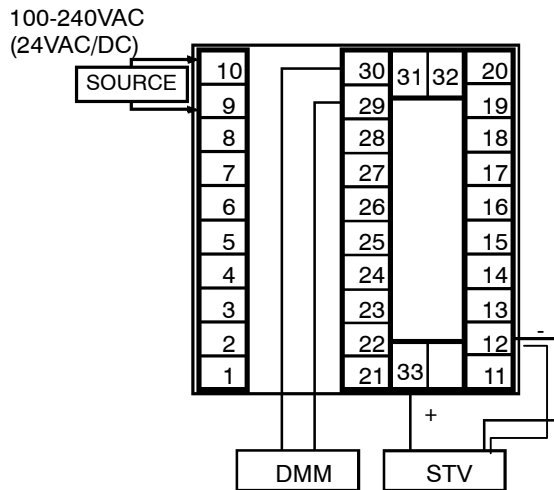

● Calibration

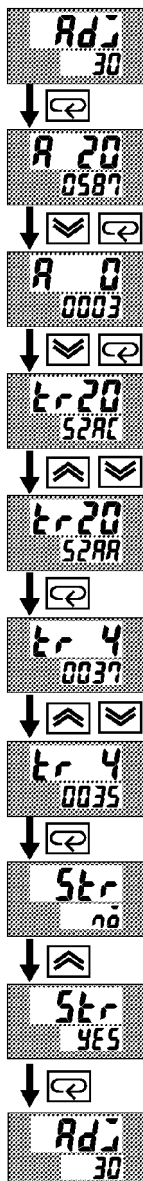

- In the above figure, STV refers to a standard DC current/voltage source, and DMM refers to a precision digital multimeter. However, note that the DMM is required only when the transfer output function is supported.

This example describes how to calibrate a platinum resistance thermometer when the transfer output function is supported. If the transfer output function is not supported, skips steps (4) to (7).

- (1) When [**Adj**] is displayed, the 30-minute timer is displayed on the No.2 display and counts down. This timer serves as a guide for the aging time when aging is required.
- (2) Press the **↻** key. The display changes to [**R 20**] (20 mA calibration display). Set the STV output to 20 mA. When the value on the No.2 display has stabilized (changes of several digits max.), press the **⏴** key to temporarily store the calibration data.
- (3) Press the **↻** key. The display changes to [**R 0**] (0 mA calibration display). Set the STV output to 0 mA. When the value on the No.2 display has stabilized (changes of several digits max.), press the **⏴** key to temporarily store the calibration data.
- (4) Next, calibrate the transfer output function. If the transfer output function is not supported, skip to step (8). Press the **↻** key. The display changes to [**Er 20**] (20 mA calibration display).
- (5) Set the output to 20 mA by the **⏴** or **⏵** keys while monitoring the voltage on the digital multimeter. In the example on the left, the display indicates that the value two digits smaller than before calibration is “20 mA”.
- (6) Press the **↻** key. The display changes to [**Er 4**] (4 mA calibration display).
- (7) Set the output to 4 mA by the **⏴** or **⏵** keys while monitoring the voltage on the digital multimeter. In the example on the left, the display indicates that the value two digits smaller than before calibration is “4 mA”.
- (8) Press the **↻** key until the display changes to the data store display. Press the **⏵** key. The No.2 display changes to [**YES**], and two seconds later the calibration data is stored to internal memory. If you press the **↻** key when the No.2 display reads [**no**], the calibration data is disabled.
- (9) This completes calibration of the current input. Press the **↻** key to return the display to [**Adj**].

7.5 Calibrating Voltage Input

● Preparation

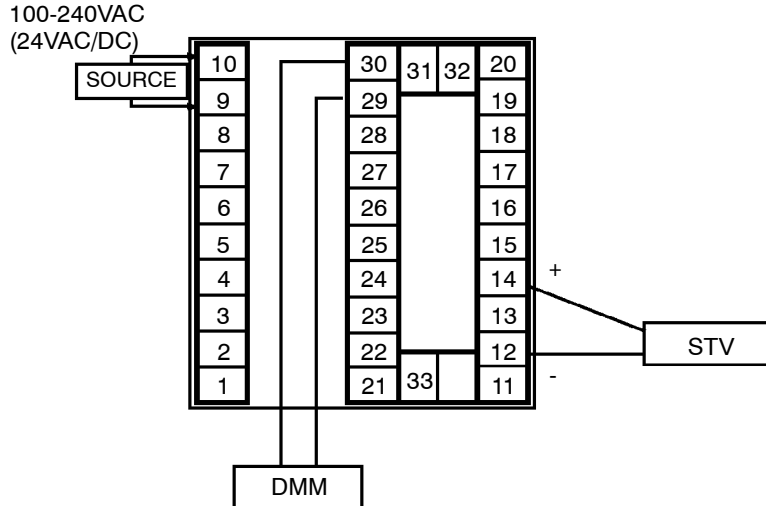

- In the above figure, STV refers to a standard DC current/voltage source, and DMM refers to a precision digital multimeter. However, note that the DMM is required only when the transfer output function is supported.

● Calibration: 0 to 5V, 1 to 5V

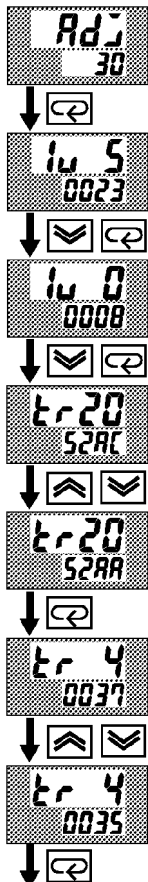

Cont'd on next page

This example describes how to calibrate a platinum resistance thermometer when the transfer output function is supported. If the transfer output function is not supported, skips steps (4) to (7).

- (1) When [$Rd\ 30$] is displayed, the 30-minute timer is displayed on the No.2 display and counts down. This timer serves as a guide for the aging time when aging is required.
- (2) Press the \square key. The display changes to [$1u\ 5$] (5 V calibration display). Set the STV output to 5 V. When the value on the No.2 display has stabilized (changes of several digits max.), press the \surd key to temporarily store the calibration data.
- (3) Press the \square key. The display changes to [$1u\ 0$] (0 V calibration display). Set the STV output to 0 V. When the value on the No.2 display has stabilized (changes of several digits max.), press the \surd key to temporarily store the calibration data.
- (4) Next, calibrate the transfer output function. If the transfer output function is not supported, skip to step (8). Press the \square key. The display changes to [$tr\ 20$] (20 mA calibration display).
- (5) Set the output to 20 mA by the \surd or \wedge keys while monitoring the voltage on the digital multimeter. In the example on the left, the display indicates that the value two digits smaller than before calibration is “20 mA”.
- (6) Press the \square key. The display changes to [$tr\ 4$] (4 mA calibration display).
- (7) Set the output to 4 mA by the \surd or \wedge keys while monitoring the voltage on the digital multimeter. In the example on the left, the display indicates that the value two digits smaller than before calibration is “4 mA”.

From previous page

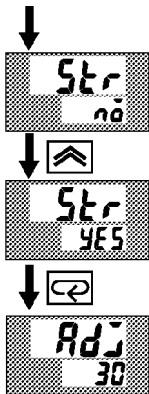

● Calibration: 0 to 10V

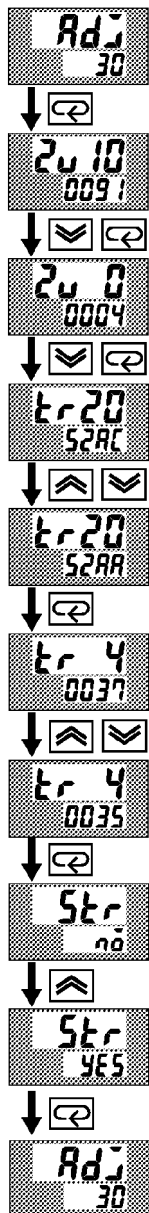

- (8) Press the key until the display changes to the data store display. Press the key. The No.2 display changes to [4E5], and two seconds later the calibration data is stored to internal memory. If you press the key when the No.2 display reads [no], the calibration data is disabled.
- (9) This completes calibration of the voltage input (0 to 5 V, 1 to 5 V). Press the key to return the display to [Adj].

This example describes how to calibrate a platinum resistance thermometer when the transfer output function is supported. If the transfer output function is not supported, skips steps (4) to (7).

- (1) When [Adj] is displayed, the 30-minute timer is displayed on the No.2 display and counts down. This timer serves as a guide for the aging time when aging is required.
- (2) Press the key. The display changes to [20 10] (10 V calibration display). Set the STV output to 10 V. When the value on the No.2 display has stabilized (changes of several digits max.), press the key to temporarily store the calibration data.
- (3) Press the key. The display changes to [20 0] (0 V calibration display). Set the STV output to 0 V. When the value on the No.2 display has stabilized (changes of several digits max.), press the key to temporarily store the calibration data.
- (4) Next, calibrate the transfer output function. If the transfer output function is not supported, skip to step (8). Press the key. The display changes to [tr 20] (20 mA calibration display).
- (5) Set the output to 20 mA by the or keys while monitoring the voltage on the digital multimeter. In the example on the left, the display indicates that the value two digits smaller than before calibration is “20 mA”.
- (6) Press the key. The display changes to [tr 4] (4 mA calibration display).
- (7) Set the output to 4 mA by the or keys while monitoring the voltage on the digital multimeter. In the example on the left, the display indicates that the value two digits smaller than before calibration is “4 mA”.
- (8) Press the key until the display changes to the data store display. Press the key. The No.2 display changes to [4E5], and two seconds later the calibration data is stored to internal memory. If you press the key when the No.2 display reads [no], the calibration data is disabled.
- (9) This completes calibration of the voltage input (0 to 10 V). Press the key to return the display to [Adj].

7.6 Checking Indication Accuracy

■ Checking indication accuracy

- After calibrating input, be sure to check indication accuracy to make sure that the E5AK-T controller has been correctly calibrated.
- Operate the E5AK-T controller in the PV/Present SP monitor (level 0 mode) mode.
- Check the indication accuracy at the upper and lower limits and mid-point.

● Thermocouple

• Preparation

The following figure shows the required device connection. Make sure that the E5AK-T controller and cold junction compensator are connected by a compensating conductor for the input type (thermocouple) that is to be used during actual operation.

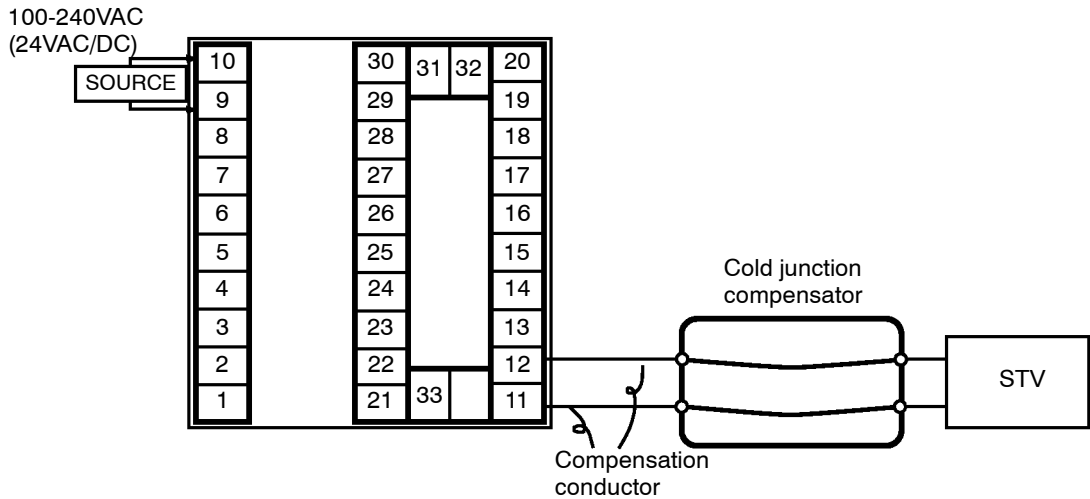

• Operation

Make sure that the cold junction compensator is at 0°C, and set STV output to the voltage equivalent to the starting power of the check value.

● Platinum resistance thermometer

• Preparation

The following figure shows the required device connection.

100-240VAC
(24VAC/DC)

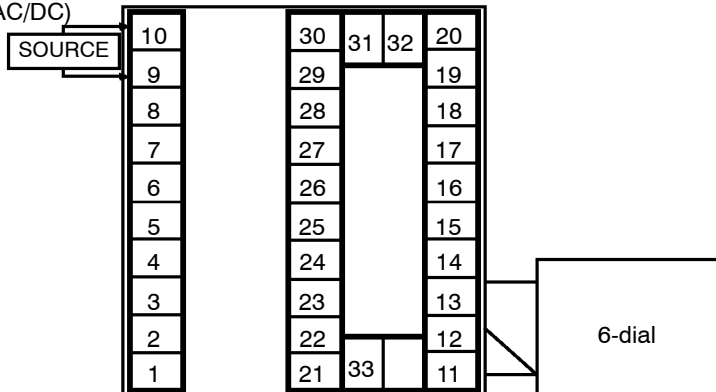

• Operation

Set the 6-dial to the resistance equivalent to the check value.

● Current input

• Preparation

The following figure shows the required device connection.

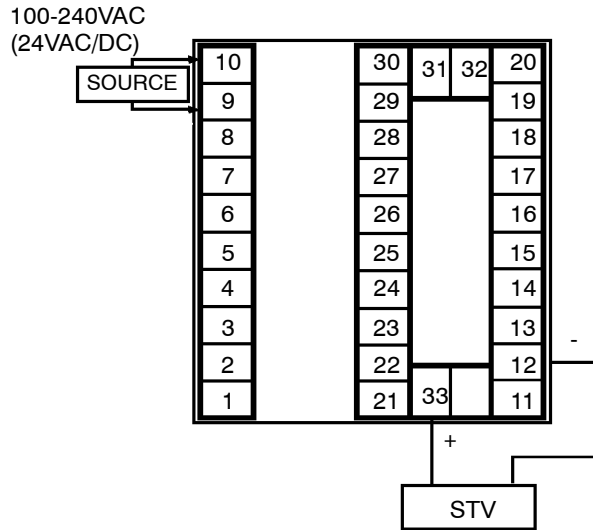

• Operation

Set the STV to the current value equivalent to the check value.

● Voltage input

• Preparation

The following figure show the required device connection.

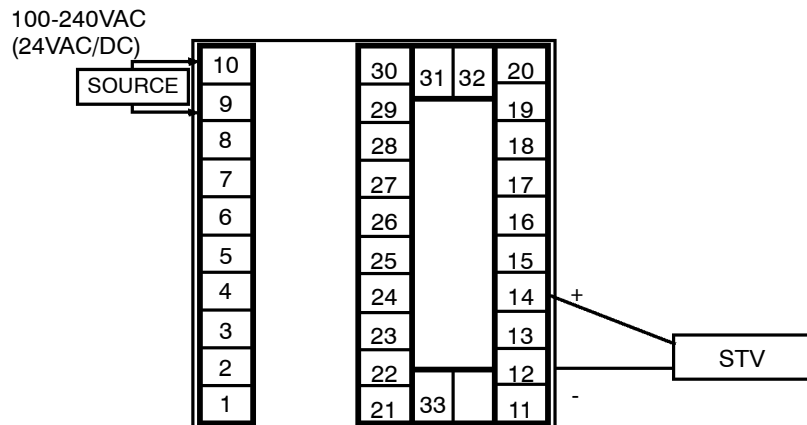

• Operation

Set the STV to the voltage value equivalent to the check value.

K CHAPTER 8

TROUBLESHOOTING

This chapter describes how to find out and remedy the cause if the E5AK-T does not function properly. Remedy E5AK-T trouble in the order of the descriptions in this chapter

8.1	Initial Checks	8-2
8.2	How to Use the Error Display	8-3
8.3	How to Use the Error Output	8-5
8.4	Checking Operation Restrictions	8-6

8.1 Initial Checks

If trouble occurs, first of all check the following:

(1) Power supply

Make sure that the power supply is ON. Also, make sure that the power supply is within the rated voltage range.

(2) Wiring

Make sure that all cables are properly connected.

(3) Communications conditions

When communicating via the RS-232C, RS-422 or RS-485 interfaces, make sure that the baud rate and other communications condition settings on the host computer and E5AK-T controller are matching, and are within the permissible ranges.

If there appears to be nothing wrong after checking the E5AK-T controller, and the same phenomenon continues, check the controller in more detail, for example, on the error display.

8.2 How to Use the Error Display

When an error has occurred, the No.1 display alternately indicates error codes together with the current display item.

This section describes how to check error codes on the display, and the actions you must take to remedy the problem.

E r r r

Input error

- **Meaning** Input is in error.
- **Action** Check the wiring of inputs, disconnections, and shorts, and check the input type.
- **Operation at error** For control output functions, the manipulated variable matched to the setting of the “MV at PV error” parameter (level 2 mode) is output. Alarm output functions are activated as if the upper limit is exceeded. Program operation is continued.

E 1 1 1

Memory error

- **Meaning** Internal memory operation is in error.
- **Action** First, turn the power OFF then back ON again. If the display remains the same, the E5AK-T controller must be repaired. If the display is restored to normal, then a probable cause can be external noise affecting the control system. Check for external noise.
- **Operation at error** Control output functions turn OFF (2 mA max. at 4 to 20 mA output, and output equivalent to 0% in case of other outputs). Alarm output functions turn OFF.

E 3 3 3

A/D converter error

- **Meaning** Internal circuits are in error.
- **Action** First, turn the power OFF then back ON again. If the display remains the same, the E5AK-T controller must be repaired. If the display is restored to normal, then a probable cause can be external noise affecting the control system. Check for external noise.
- **Operation at error** Control output functions turn OFF (2 mA max. at 4 to 20 mA output, and output equivalent to 0% in case of other outputs). Alarm output functions turn OFF. Program operation is stopped.

Calibration data error

This error is output only during temperature input, and is displayed for two seconds when the power is turned ON.

- **Meaning** Calibration data is in error.
- **Action** E5AK-T must be repaired.
- **Operation at error** Both control output functions and alarm output functions operate. However, note that readout accuracy is not assured.

Display range over

- **Meaning** Though not an error, this is displayed when the process value exceeds the display range when the control range (setting range \times 10%) is larger than the display range (-1999 to 9999).
 - When less than “-1999” [c c c c]
 - When greater than “9999” [c c c c]
- **Operation** Control continues, allowing normal operation.

**About Errors That Occur During Motor Calibration**

If an error occurs during motor calibration, [Err] is displayed on the No.2 display. The following causes of errors are possible:

- Control motor or potentiometer malfunction
- Incorrect control motor or potentiometer wiring
- Potentiometer is not connected

8.3 How to Use the Error Output

The E5AK-T controller allows you to assign error output to terminals as outputs.

For details on output assignments, see 3.3 Setting Output Specifications (page 3-7).

● LBA

- LBA (Loop Break Alarm) can be used as a means for detecting loop breaks when the control loop is not functioning normally. For details, see page 4-26.
- LBA allows you to detect the following errors:
 - (1) Heater burnout (HBA)
 - (2) Output error (contact weld, damaged transistors, etc.)
 - (3) Sensor error (constant input values, etc.)
- If you use the LBA function, set the loop break detection time matched to the control characteristics in the “LBA detection time” parameter (level 2 mode).

● Input errors

- If you assign error 1 as the output, an error can be output to auxiliary output 1 or auxiliary output 2 when input is in error. When this error occurs, remedy by following the description for “Input error”.

● A/D converter error

- If you assign error 2 as the output, an error can be output to auxiliary output 1 or auxiliary output 2 when the A/D converter is in error. When this error occurs, remedy by following the description for “A/D converter error”.

8.4 Checking Operation Restrictions

With the E5AK-T controller, auto-tuning or self-tuning sometimes do not operate depending on how functions are combined. The table below summarizes the main operating restrictions.

If the E5AK-T controller is not operating properly, first check whether operating conditions violate the restrictions in this table.

Restriction	Inoperable or Invalid Functions		
	AT Execution	Limiter Function	Other
At heating and cooling control	40%AT		
At position-proportional control	40% AT	Manipulated variable	ON/OFF control
At ON/OFF control	×	Manipulated variable MV change rate	
At AT execution		MV change rate	Parameter setting
At reset	×	Manipulated variable MV change rate	

Items marked by a “x” indicate combinations of conditions that are not acceptable during AT execution.

K APPENDIX

SPECIFICATIONS	A-2
ABOUT CURRENT TRANSFORMER (CT) ...	A-5
CONTROL BLOCK DIAGRAM	A-6
SETTING LIST	A-8
MODEL LIST	A-11
PARAMETER OPERATIONS LIST	A-12
ASCII CODE LIST	A-14

SPECIFICATIONS

■ Ratings

Supply voltage	100 to 240V AC, 50/60 Hz	24 VAC/DC, 50/60 Hz
Operating Voltage Range	85% to 110% of rated supply voltage	
Power Consumption	16VA	12 VA, 8 W
Sensor Input	Thermocouple: K, J, T, E, L, U, N, R, S, B, W, PLII *1, *2 *1, *2 Platinum resistance thermometer: JPt100, Pt100 Voltage input: 4 to 20 mA, 0 to 20 mA (input impedance 150Ω) Current input: 1 to 5 V, 0 to 5 V, 0 to 10 V (input impedance 1MΩ)	
Sub-Input	CT input: E54-CT1, E54-CT3 Potentiometer: 100Ω to 2.5 kΩ	
Control Output	According to output unit (see "Output Unit Ratings and Characteristics" (page A-4))	
Auxiliary Output	SPST-NO, 3 A at 250 VAC (resistive load)	
Control Method	Advanced PID or ON/OFF control	
Setting Method	Digital setting using front panel keys.	
Indication Method	7-segment digital display, bar graph and LEDs	
Other Functions	According to option unit (see "Option Unit Ratings and Characteristics" (page A-4))	
Ambient Temperature	-10°C to 55°C (without condensation and icing)/3-year warranty period: -10 to 50°C	
Ambient Humidity	35% to 85% (relative humidity)	
Storage Temperature	-25°C to 65°C (without condensation and icing)	

*1 Thermocouple W is W/Re5-26.

*2 For the setting ranges and indication ranges for each of inputs, see page A-4.

Characteristics

Indication Accuracy	Thermometer: ($\pm 0.3\%$ of indication value or $\pm 1^\circ\text{C}$, whichever greater) ± 1 digit max. (*1) Platinum resistance thermometer: ($\pm 0.2\%$ of indication value or $\pm 0.8^\circ\text{C}$ whichever greater) ± 1 digit max. Analog input: $\pm 0.2\%F \pm S1$ digit max. CT input: $5 \pm \%FS \pm 1$ digit max. Potentiometer: $\pm 5\%FS \pm 1$ digit max.	
Temperature variation influence (*2)	Platinum resistance thermometer: ($\pm 1\%$ of PV or $\pm 2^\circ\text{C}$, whichever greater) ± 1 digit max. Thermocouple (R, S, B, W): ($\pm 1\%$ of PV or $\pm 10^\circ\text{C}$, whichever greater) ± 1 digit max. Other thermocouples (K1, K2, J1, J2, E, N, T, L1, L2, U, PLII): ($\pm 1\%$ of PV or $\pm 4^\circ\text{C}$, whichever greater) ± 1 digit max. Analog input (current, voltage, or remote SP input): $\pm 1\%FS \pm 1$ digit max.	
Voltage variation influence (*2)		
Hysteresis	0.01 to 99.99%FS (in units of 0.1%FS)	
Proportional Band (P)	0.1 to 999.9%FS (in units of 0.1%FS)	
Integral Time (I)	0 to 3999s (in units of 1 second) (*3)	
Derivative Time (D)	0 to 3999s (in units of 1 second)	
Control Period	1 to 99s (in units of 1 second)	
Manual Reset Value	0.0 to 100.0% (in units of 0.1%)	
Alarm Setting Range	-1999 to 9999 (decimal point position dependent on input type)	
Sampling Period	Temperature input: 250 ms, Analog input: 100 ms, Sub-input: 1s	
Program Method	Set time or rate of rise programming	
Program Size	8 patterns, Max. 16 steps/pattern	
Program Time Accuracy	$\pm 0.2\% \pm 500$ ms of set value (even-numbered steps in the "rate of rise programming" setting are set to the time unit of ramp rate)	
Insulation Resistance	20 M Ω min. (at 500 VDC)	
Dielectric Strength	2000 VAC, 50/60 Hz for 1 min. (between electrically live terminals of different polarities)	
Vibration Resistance	Malfunction	10 to 55 Hz, 10m/s ² {approx. 1G} for 10 min. each in X, Y, and Z directions
	Destruction	10 to 55 Hz, 10m/s ² {approx. 2G} for 2 hrs. each in X, Y, and Z directions
Shock Resistance	Malfunction	200 m/s ² min. {approx. 20G}, 3 times each in 6 directions (100 m/s ² {approx. 10G} applied to the relay)
	Destruction	300 m/s ² min. {approx. 30G}, 3 times each in 6 directions
Weight	Approx. 450 g, mounting bracket: approx. 65 g	
Enclosure Ratings	Front panel: NEMA4 for indoor use (equivalent to IP66) Fear case: IP20 Terminals: IP00	
Memory Protection	Non-volatile memory (number of writes: 100,000) (*4)	

*1 The indication accuracy of the K1, T and N thermocouples at a temperature of -100°C or less is $\pm 2^\circ\text{C} \pm 1$ digit maximum. The indication accuracy of the U, L1 and L2 thermocouples at any temperature is $\pm 2^\circ\text{C} \pm 1$ digit maximum. The indication accuracy of the B thermocouple at a temperature of 400°C or less is unrestricted. The indication accuracy of the R and S thermocouples at a temperature of 200°C or less is $\pm 3^\circ\text{C} \pm 1$ digit maximum. The indication accuracy of the W thermocouple ± 1 digit max. of whichever is the greater of $\pm 0.3\%$ or $\pm 3^\circ\text{C}$ of the indicated value. The indication accuracy of the PLII thermocouple is ± 1 digit max. of whichever is the greater of $\pm 0.3\%$ or $\pm 2^\circ\text{C}$ of the indicated value.

*2 Ambient temperature: -10°C to 23°C to 55°C
 Voltage range: -15 to $+10\%$ of rated voltage

*3 On a position-proportional type controllers, 1 to 3999.

*4 Changes to parameters and switched remote/local settings are written.

Heater Burnout Alarm

Max. heater current	Single-phase 50 A VAC
Heater current value indication accuracy	$\pm 5\%FS \pm 1$ digit max.
Heater burnout alarm setting range	0.1 to 49.9 A (in units of 0.1 A) (*1)
Min. detection ON time	190 ms (*2)

*1 0.0 A: The heater burnout alarm turns OFF. 50.0 A: The heater burnout alarm turns ON.

*2 No heater burnout detection or heater current value measurement is possible if the control output is ON for less than 190 ms.

■ Sensor Input Setting Ranges and Indication Ranges

Input	Setting Range	Indication Range
JPt100	-199.9 to 650.0 (C°) / -199.9 to 999.9 (F°)	-199.9 to 735.0 (C°) / -199.9 to 999.9 (F°)
Pt100	-199.9 to 650.0 (C°) / -199.9 to 999.9 (F°)	-199.9 to 735.0 (C°) / -199.9 to 999.9 (F°)
K1	-200 to 1300 (C°) / -300 to 2300 (F°)	-350 to 1450 (C°) / -560 to 2560 (F°)
K2	-0.0 to 500.0 (C°) / -0.0 to 900.0 (F°)	-50.0 to 550.0 (C°) / -90.0 to 990.0 (F°)
J1	-100 to 850 (C°) / -100 to 1500 (F°)	-195 to 945 (C°) / -260 to 1660 (F°)
J2	-0.0 to 400.0 (C°) / -0.0 to 750.0 (F°)	-40.0 to 440.0 (C°) / -75.0 to 825.0 (F°)
T	-199.9 to 400.0 (C°) / -199.9 to 700.0 (F°)	-199.9 to 460.0 (C°) / -199.9 to 790.0 (F°)
E	0 to 600 (C°) / -0 to 1100 (F°)	-60 to 660.0 (C°) / -110 to 1210 (F°)
L1	-100 to 850 (C°) / -100 to 1500 (F°)	-195 to 945 (C°) / -260 to 1660 (F°)
L2	0.0 to 400.0 (C°) / 0.0 to 750.0 (F°)	-40.0 to 440.0 (C°) / -75.0 to 825.0 (F°)
U	-199.9 to 400.0 (C°) / -199.9 to 700.0 (F°)	-199.9 to 650.0 (C°) / -199.9 to 999.9 (F°)
N	-200.0 to 1300 (C°) / -300 to 2300 (F°)	-199.9 to 460.0 (C°) / -199.9 to 790.0 (F°)
R	0 to 1700 (C°) / 0 to 3000 (F°)	-350 to 1450 (C°) / -560 to 2560 (F°)
S	0 to 1700 (C°) / 0 to 3000 (F°)	-170 to 1870 (C°) / -300 to 3300 (F°)
B	100 to 1800 (C°) / 300 to 3200 (F°)	-170 to 1870 (C°) / -300 to 3300 (F°)
W	0 to 2300 (C°) / 0 to 4100 (F°)	-70 to 1970 (C°) / 10 to 3490 (F°)
PL	0 to 1300 (C°) / 0 to 2300 (F°)	-230 to 2530 (C°) / -410 to 4510 (F°)
4 to 20mA 0 to 20mA 1 to 5V 0 to 5V 0 to 10V	One of following ranges depending on results of scaling -1999 to 9999 -199.9 to 999.9 -19.99 to 99.99 -1.999 to 9.999	-10 to 110% of setting range. Note, however, that max. value is -1999 to 9999.

■ Output Unit Ratings and Characteristics

Ratings and characteristics conform to the output unit mounted on the controller. For details on the ratings of the output unit, see page 2-7.

The relay output unit is already mounted on the E5AK-TPRR[[]].

(When the output unit is replaced, use the E53-R.)

■ Option Unit Ratings and Characteristics

Event inputs	Contact input	ON: 1kΩ max., OFF: 100kΩ min.
	No-contact input	ON: residual voltage 1.5 V max., OFF: leakage current 0.1 mA max.
Communications	Interface	:RS-232C, RS-422 or RS-485
	Transmission method	:Half-duplex
	Synchronization method	:Start-stop synchronization (asynchronous method)
	Baud rate	:1.2/2.4/4.8/9.6/19.2 kbps
Transfer output	DC 4 to 20 mA, Permissible load impedance: 600Ω max., Resolution: Approx. 2600	

ABOUT CURRENT TRANSFORMER (CT)

● Specifications

Item	Specifications	
Type	E54-CT1	E54-CT3
Max. continuous heater current	50A	120A (*1)
Dielectric Strength	1000 VAC (1 min.)	
Vibration Resistance	50 Hz, 98 m/s ² {10G}	
Weight	Approx. 11.5g	Approx. 50g
Accessory	-	Armature (2), Plug (2)

*1 The maximum continuous current of the E5AK-T is 50 A.

● Dimensions

E54-CT1

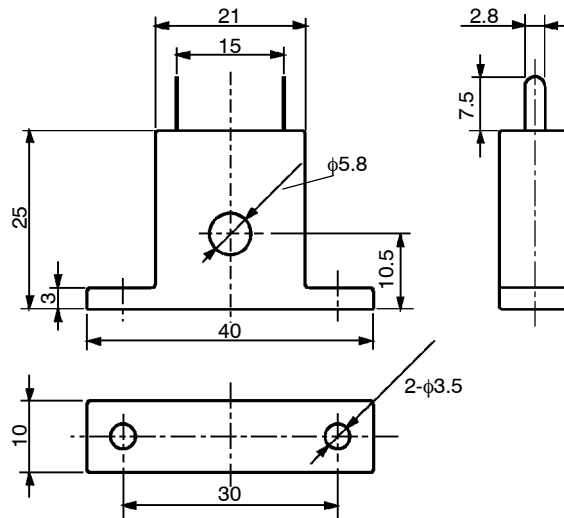

E54-CT3

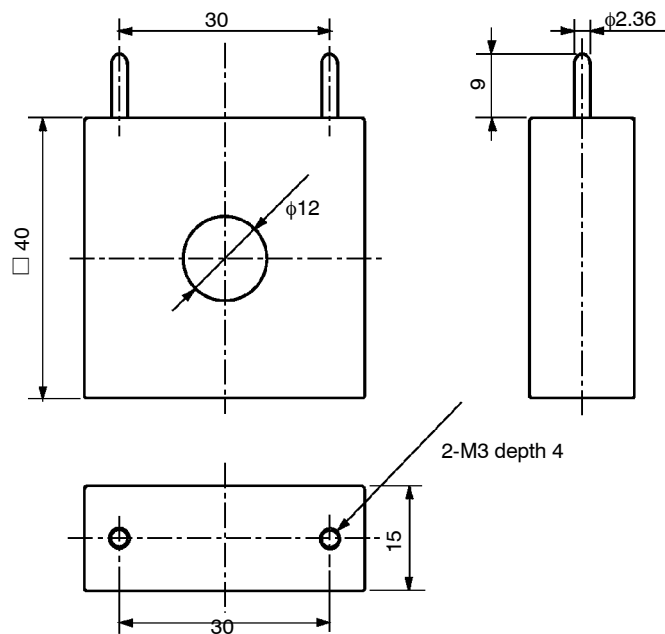

CONTROL BLOCK DIAGRAM

Standard type

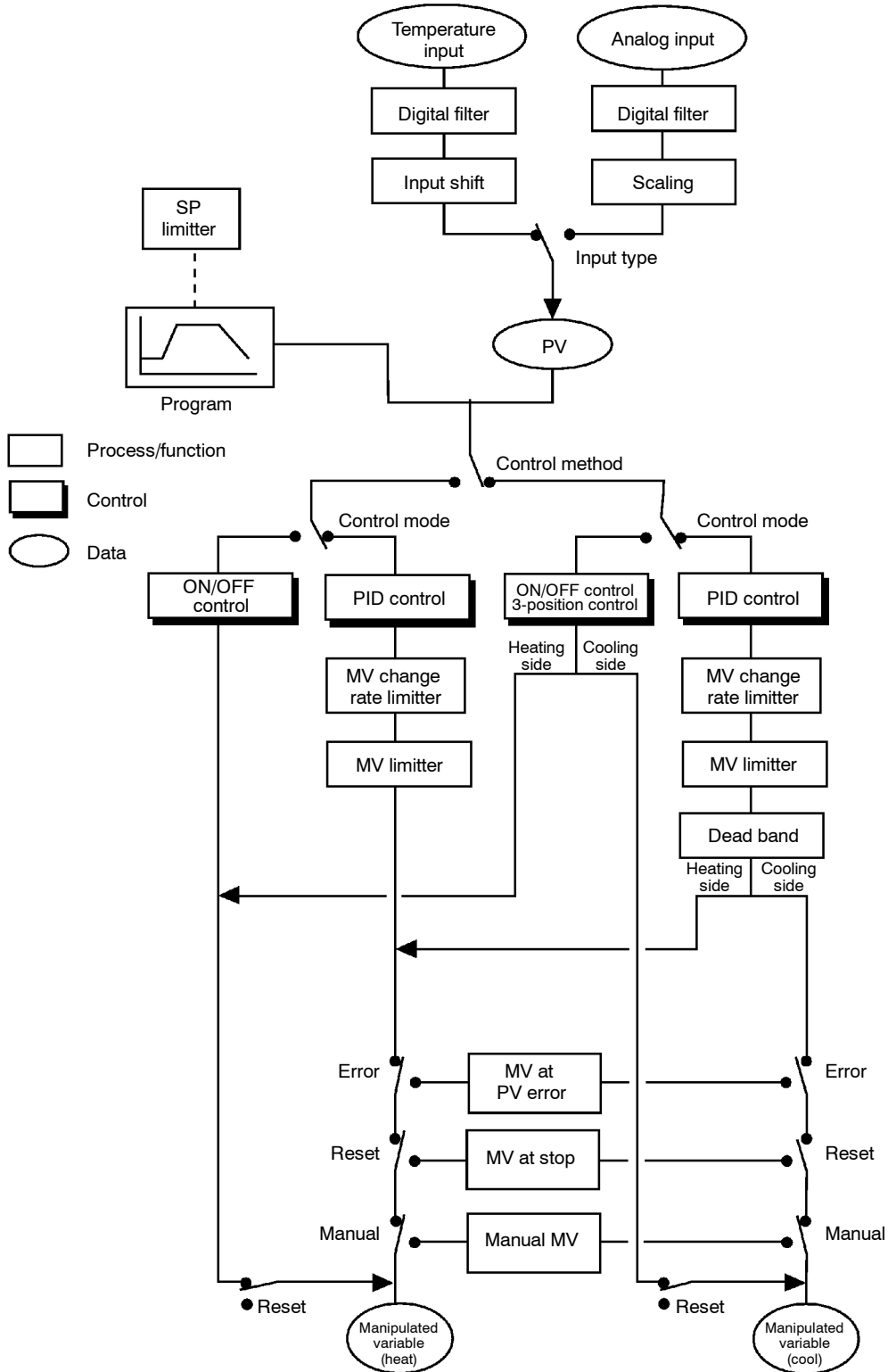

Position-proportional type

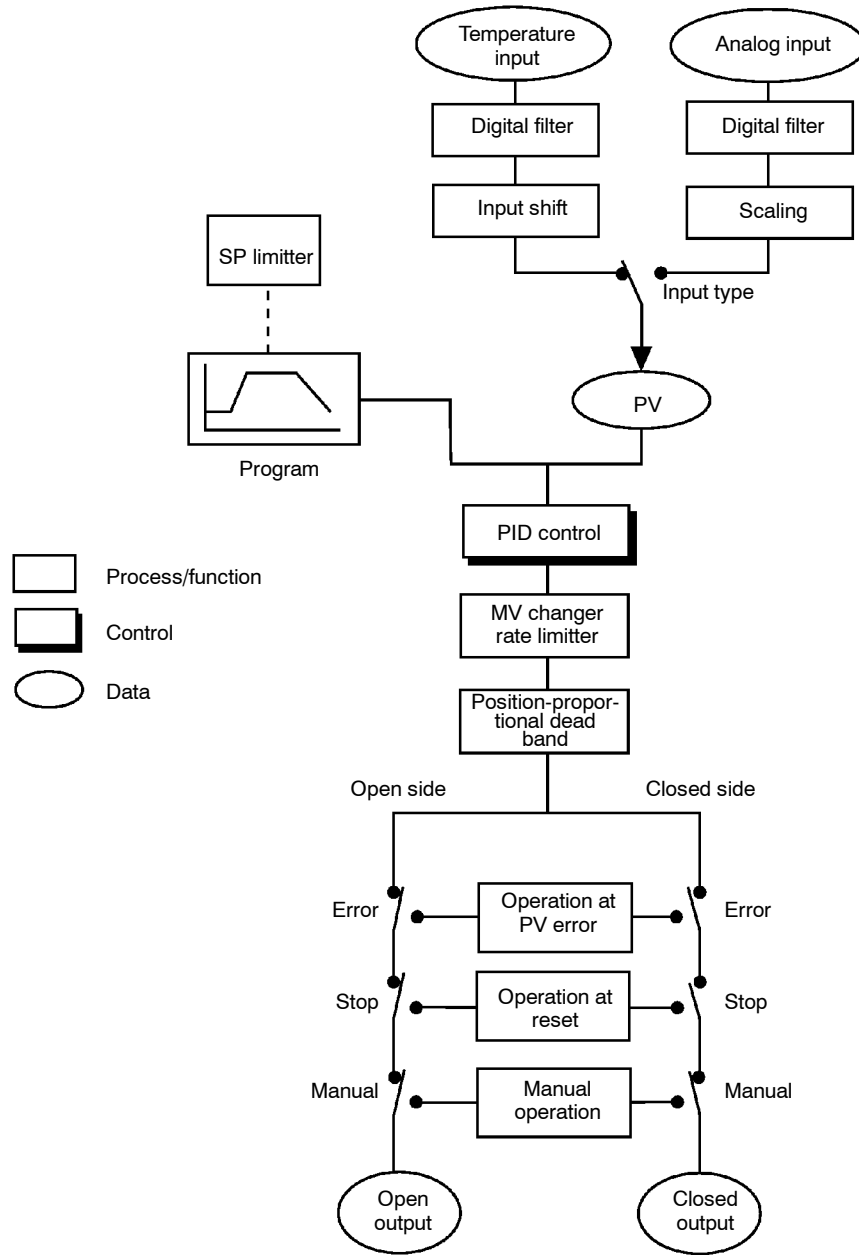

SETTING LIST

Mode	Parameter Name	Setting Range	Unit	Default	Remarks	Setting
Protect	SECr Security	0 to 6	None	1		
	KEYP Key protect	0/1/2/3	None	0		
Manual	Manual MV	-5.0 to 105.0*1 *1	%	0.0		
Level 0	PLrn Pattern No.	0 to 7	None	0		
	HOLD Hold	OFF/ON	None	OFF	At program operation	
	Adv Advance	OFF/ON	None	OFF	At program operation	
Program	PLrn Pattern No.	0 to 7	None	0		
	S-ns Number of steps	1 to 16	None	8		
	SP0 to 15 Steps 0 to 15 SP/ Target SP 0 to 7	SP lower limit to SP upper limit	EU	0		*2
	PR0 to 7 Ramp rate 0 to 7	0 to 9999	*3	0		*2
	EL0 to 15 Step 0 to 15 time/ Soak time 0 to 7	0.00 to 99.59	*4	0.00		*2
	rPt Pattern execution count	0 to 9999	Times	1		
	AL-1 Alarm value 1	-1999 to 9999	EU	0		
	AL-2 Alarm value 2	-1999 to 9999	EU	0		
	AL-3 Alarm value 3	-1999 to 9999	EU	0		
	ES15 Time signal 1 enabled step	0 to 15	None	0		
	on1 Time signal 1 ON time	0.00 to 99.59	*4	0.00		
	off1 Time signal 1 OFF time	0.00 to 99.59	*4	0.00		
	ES25 Time signal 2 enabled step	0 to 15	None	0		
	on2 Time signal 2 ON time	0.00 to 99.59	*4	0.00		
off2 Time signal 2 OFF time	0.00 to 99.59	*4	0.00			
Level 1	At AT Execute/Cancel	OFF/ AT-1/AT-2	None	OFF		
	P Proportional band	0.1 to 999.9	%FS	10.0		
	I Integral time	0 to 3999	sec	233		
	d Derivative time	0 to 3999	sec	40		
	C-SC Cooling coefficient	0.01 to 99.99	None	1.00	At heating and cooling control	
	C-db Dead band	-19.99 to 99.99	%FS	0.00	At heating and cooling control	
	db Position-proportional dead band	0.1 to 10.0	%	2.0	At position-proportional control	
	off-r Manual reset value	0.0 to 100.0	%	50.0		
	HYS Hysteresis (heat)	0.01 to 99.99	%FS	0.10		
	[HYS Hysteresis (cool)	0.01 to 99.99	%FS	0.10	At heating and cooling control	
	[P Control period (heat)	1 to 99	sec	20		
	[-CP Control period (cool)	1 to 99	sec	20	At heating and cooling control	
Hb Heater burnout	0.0 to 50.0	A	0.0	Heater burnout detection		

Mode	Parameter Name	Setting Range	Unit	Default	Remarks	Setting
Level 2	r-L Remote/Local	RMT/LCL	None	LCL		
	Stb Standby time	0.00 to 99.59	Hour, Min.	0.00		
	LbA LBA detection time	0 to 9999	Sec	0		
	ñu-r MV at reset	-5.0 to 105.0 *1	%	0.0		
	ñu-E MV at PV error	-5.0 to 105.0 *2	%	0.0		
	õL-H MV upper limit	MV lower limit +0.1 to 105.0 *5	%	105.0		
	õL-L MV lower limit	-5.0 to MV upper limit -0.1 *6	%	-5.0		
	õrL MV change rate limiter	0.0 to 100.0	%FS	0.0		
	õnF Input digital filter	0 to 9999	sec	0		
	õC-H Open/close hysteresis	0.1 to 20.0	%	0.8		
	ALH1 Alarm 1 hysteresis	0.01 to 99.99	%FS	0.02		
	ALH2 Alarm 2 hysteresis	0.01 to 99.99	%FS	0.02		
	ALH3 Alarm 3 hysteresis	0.01 to 99.99	%FS	0.02		
	õnSH Input shift upper limit	-199.9 to 999.9	°C/°F	0.0	Temperature input	
	õnSL Input shift lower limit	-199.9 to 999.9	°C/°F	0.0	Temperature input	
Setup	õn-E Input type	0 to 21	None	2		
	õn-H Scaling upper limit	Scaling lower limit +1 to 9999	None	100	Analog input	
	õn-L Scaling lower limit	-1999 to scaling upper limit -1	None	0	Analog input	
	dP Decimal point	0 to 3	None	0	Analog input	
	d-U °C/°F selection	°C/°F	None	°C	Temperature input	
	õnõE Parameter initialize	Yes/No	None	NO		
	õUõ1 Control output 1 assignment	*7	None	HEAT		
	õUõ2 Control output 2 assignment	*7	None	AL-1		
	SUõ1 Auxiliary output 1 assignment	*8	None	AL-2		
	SUõ2 Auxiliary output 2 assignment	*8	None	AL-3		
	ALõ1 Alarm 1 type	1 to 11	None	2	Output assignment needed	
	ALõn Alarm 1 open in alarm	N-O/N-C	None	N-O	Output assignment needed	
	ALõ2 Alarm 2 type	1 to 11	None	2	Output assignment needed	
	ALõn Alarm 2 open in alarm	N-O/N-C	None	N-O	Output assignment needed	
	ALõ3 Alarm 3 type	1 to 11	None	2	Output assignment needed	
ALõn Alarm 3 open in alarm	N-O/N-C	None	N-O	Output assignment needed		
õrõu Direct/Reverse operation	OR-R/OR-D	None	OR-R			

*1 During heating and cooling control, the lower limit becomes -105.0%

*2 Use "Program List" (page A-11) for the setting value of each step.

*3 EU/time unit of ramp rate

*4 Program time unit

*5 During heating and cooling control, the setting range becomes 0.0 to 105.0%.

*6 During heating and cooling control, the setting range becomes -105.0 to 0.0%.

*7 HEAT/COOL/AL-1/AL-2/AL-3/HBA/LBA/TS-1/TS-2/PEND/STG

*8 AL-1/AL-2/AL-3/HBA/LBA/TS-1/TS-2/PEND/STG/S.ERR/E333

Mode	Parameter Name	Setting Range	Unit	Default	Remarks	Setting	
Expansion	SL-H	Set point upper limit	Set point lower limit +1 to scaling upper limit	EU	1300	*9	
	SL-L	Set point lower limit	Scaling lower limit to Set point upper limit -1	EU	-200	*9	
	EntL	PID / ON/OFF	PID / ON/OFF	None	PID		
	P-on	Operation at power ON	CON/RST/RUN/MAN	None	CON		
	ESEt	End condition	RST/SP	None	RST		
	t-U	Program time unit	HHMM/MMSS	None	HHMM		
	t-Pr	Step time/Rate of rise programming	TIME/PR	None	OFF		
	Pr-U	Time unit of ramp rate	M/H	None	OFF		
	PnSt	PV start	PV/SP	None	SP		
	Wt-b	Wait width	0 to 9999	EU	0		
	rPAL	Alarm during ramp step enable	ON/OFF	None	ON		
	rUnA	Run all enable	ON/OFF	None	OFF		
	ALFA	α	0.00 to 1.00	None	0.65		
	At-C	AT calculated gain	0.1 to 10.0	None	1.0		
	rEt	Automatic return of display mode	0 to 99	Sec	0		
	At-H	AT hysteresis	0.1 to 9.9	%FS	0.2		
	LBAb	LB detection width	0.0 to 999.9	%FS	0.2		
Option	Ev-1	Event input assignment 1	NON/RST/MAN/HOLD/ADV/PTN0 to 2	None	NON		
	Ev-2	Event input assignment 2	NON/RST/MAN/HOLD/ADV/PTN0 to 2	None	NON		
	Ev-3	Event input assignment 3	NON/RST/RMT/MAN/HOLD/ADV/PTN0 to 2	None	NON		
	Ev-4	Event input assignment 4	NON/RST/RMT/MAN/HOLD/ADV/PTN0 to 2	None	NON		
	SbLt	Communication stop bit	1/2	bit	2		
	LEn	Communication data length	7/8	bit	7		
	Prty	Communication parity	NONE/EVEN/ODD	None	EVEN		
	bPS	Communication baud rate	1.2/2.4/4.8/9.6/19.2	kbps	9.6		
	U-nō	Communication unit No.	0 to 99	None	0		
	t-r-t	Transfer output type	SP/PV/O/C-O/V-M	None	SP		
	t-r-H	Transfer output upper limit	*11	*11	*10		
	t-r-L	Transfer output lower limit	*11	*11	*10		
	HbL	HBA latch	ON/OFF	None	OFF		
	CRlb	Motor calibration	ON/OFF	None	OFF		
	nōt	Travel time	1 to 999	Sec	30		
	P-db	PV dead band	0 to 9999	EU	0		

*9 When temperature input is selected, the range of the sensor selected in the “input type” parameter (setup mode) corresponds to the scaling upper and lower limit value.

*10 Set the transfer output type parameter according to the following table.

Transfer Output Type	Transfer Output Lower Limit to Transfer Output Upper Limit
SP :Present SP	-1999 to 9999
PV :Process value	-1999 to 9999
O :Manipulated variable (heat)	-5.0 to 105.0% (standard control), 0.0 to 105.0% (heating and cooling control)
C-O :Manipulated variable (cool)	0.0 to 105.0%
V-M :Valve opening	-10.0 to 110.0%

- Default : [SP]

Time Setup Program List

Program name

Pattern No. Pattern execution count Program time unit: Hour, minute/minute, second

Alarm value 1: /2: /3:

Pattern										
Step										
Set point										
Time										
Time signal 1	ON									
	OFF									
Time signal 2	ON									
	OFF									

MODEL LIST

Description	Type Name	Specification
Base unit	E5AK-TAA2 AC100-240	Standard model
	E5AK-TAA2-500 AC100-240	Standard model with terminal cover
	E5AK-TAA2 AC/DC24	Standard model
	E5AK-TAA2-500 AC/DC24	Standard model with terminal cover
	E5AK-TPRR2 AC100-240	Position-proportional model
	E5AK-TPRR2-500 AC100-240	Position-proportional model with terminal cover
	E5AK-TPRR2 AC/DC24	Position-proportional model
	E5AK-TPRR2-500 AC/DC24	Position-proportional model with terminal cover
Option unit	E53-AKB	Event input
	E53-AK01	Communication (RS-232C)
	E53-AK02	Communication (RS-422)
	E53-AK03	Communication (RS-485)
	E53-AKF	Transfer output
Output unit	E53-R	Relay
	E53-S	SSR
	E53-Q	Pulse (NPN) DC12V
	E53-Q3	Pulse (NPN) DC24V
	E53-Q4	Pulse (PNP) DC24V
	E53-C3	Linear (4 to 20mA)
	E53-C3D	Linear (0 to 20mA)
	E53-V34	Linear (0 to 10V)
	E53-V35	Linear (0 to 5V)
Terminal cover	E53-COV0809	for E5AK

PARAMETER OPERATIONS LIST

- Switching to modes other than the manual or protect mode is carried out by mode selection in the menu display.
- The figure below shows all parameters in the order that they are displayed. Some parameters are not displayed depending on the protect mode setting and conditions of use.

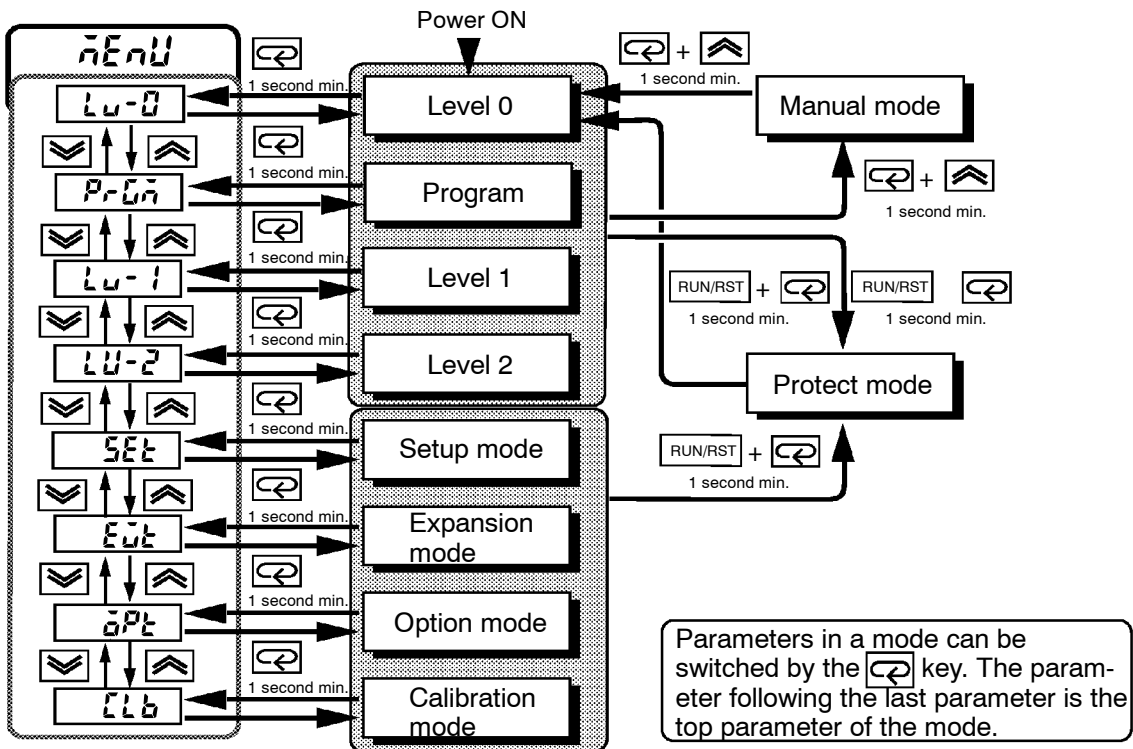

Level 0

[]	PV/Present SP
<i>Pt rn</i>	Pattern No.
<i>St EP</i>	Step No. monitor
<i>HöLd</i>	Hold
<i>Adv</i>	Advance
<i>St bñ</i>	Standby time monitor
<i>tLñE</i>	Pattern elapsing time monitor
<i>rPtñ</i>	Pattern execution count monitor
<i>ö</i>	MV monitor (heat)
<i>[-ö</i>	MV monitor (cool)
<i>n-ñ</i>	Valve opening monitor

Program

<i>Pt rn</i>	Pattern No.	
<i>S-nö</i>	Number of steps	
<i>SP0to7</i>	Step 0 to 7 SP	*1
<i>Pr0to7</i>	Ramp rate 0 to 7	*1
<i>tL0to7</i>	Step 0 to 7 time	
<i>SP8to15</i>	Step 8 to 15 SP	
<i>tL8to15</i>	Step 8 to 15 time	
<i>rPt</i>	Pattern execution count	
<i>AL-1</i>	Alarm value 1	
<i>AL-2</i>	Alarm value 2	
<i>AL-3</i>	Alarm value 3	
<i>tS1S</i>	Time signal 1 step selection	
<i>ön1</i>	Time signal 1 ON time	
<i>öF1</i>	Time signal 1 OFF time	
<i>tS2S</i>	Time signal 2 step selection	
<i>ön2</i>	Time signal 2 ON time	
<i>öF2</i>	Time signal 2 OFF time	

Level 1

<i>At</i>	AT Execute/Cancel
<i>P</i>	Proportional band
<i>I</i>	Integral time
<i>d</i>	Derivative time
<i>[-S[-</i>	Cooling coefficient
<i>[-db</i>	Dead band
<i>db</i>	Position-proportional dead band
<i>öF-r</i>	Manual reset value
<i>HYS</i>	Hysteresis (heat)
<i>[HYS</i>	Hysteresis (cool)
<i>[P</i>	Control period (heat)
<i>[-[P</i>	Control period (cool)
<i>[t</i>	Heater current monitor
<i>Hb</i>	Heater burnout

*1 In the rate of rise setting, Target SP 0 to 7 and Soak time 0 to 7.

Level 2	Setup	Expansion
<i>r-l</i> Remote/Local	<i>in-t</i> Input type	<i>SL-H</i> Set point upper limit
<i>Stb</i> Standby time	<i>in-H</i> Scaling upper limit	<i>SL-L</i> Set point lower limit
<i>LbA</i> LBA detection time	<i>in-L</i> Scaling lower limit	<i>OnL</i> PID / ON/OFF
<i>rv-r</i> MV at reset	<i>dp</i> Decimal point	<i>P-on</i> Operation at power ON
<i>rv-E</i> MV at PV error	<i>d-U</i> °C/°F selection	<i>ESEt</i> End condition
<i>ul-H</i> MV upper limit	<i>inL</i> Parameter initialize	<i>t-U</i> Program time unit
<i>ul-L</i> MV lower limit	<i>out 1</i> Control output 1 assignment	<i>t-Pr</i> Step time/Rate of rise programming
<i>orL</i> MV change rate limit	<i>out 2</i> Control output 2 assignment	<i>Pr-U</i> Time unit of ramp rate
<i>inF</i> Input digital filter	<i>Sub 1</i> Auxiliary output 1 assignment	<i>PnSt</i> PV start
<i>oC-H</i> Open/Close hysteresis	<i>Sub 2</i> Auxiliary output 2 assignment	<i>yt-b</i> Wait width
<i>ALH1</i> Alarm 1 hysteresis	<i>ALt 1</i> Alarm 1 type	<i>r-UnA</i> Alarm during ramp step enable
<i>ALH2</i> Alarm 2 hysteresis	<i>AL 1n</i> Alarm 1 open in alarm	<i>r-PAL</i> Run all enable
<i>ALH3</i> Alarm 3 hysteresis	<i>ALt 2</i> Alarm 2 type	<i>ALFA</i> α
<i>inSH</i> Input shift upper limit	<i>AL 2n</i> Alarm 2 open in alarm	<i>At-G</i> AT calculated gain
<i>inSL</i> Input shift lower limit	<i>ALt 3</i> Alarm 3 type	<i>r-Et</i> Automatic return of display mode
	<i>AL 3n</i> Alarm 3 open in alarm	<i>At-H</i> AT hysteresis
	<i>or-Eu</i> Direct/Reverse operation	<i>LbAb</i> LBA detection width

Option	Calibration
<i>Eu-1</i> Event input assignment 1	For details, refer to Chapter 7 Calibration/7.1 Structure of Parameters" (page 7-2).
<i>Eu-2</i> Event input assignment 2	
<i>Eu-3</i> Event input assignment 3	
<i>Eu-4</i> Event input assignment 4	
<i>SbL</i> Communication stop bit	Manual
<i>LEn</i> Communication data length	<input type="checkbox"/> Manual MV
<i>Prty</i> Communication parity	Protect
<i>bPS</i> Communication baud rate	<i>SECr</i> Security
<i>U-nō</i> Communication unit No.	<i>KEYP</i> Key protect
<i>tr-t</i> Transfer output type	
<i>tr-H</i> Transfer output upper limit	
<i>tr-L</i> Transfer output lower limit	
<i>HbL</i> HBA latch	
<i>CALb</i> Motor calibration	
<i>nōt</i> Travel time	
<i>P-db</i> PV dead band	

ASCII CODE LIST

Hex		0	1	2	3	4	5	6	7	Upper 4 bits
	Bin	0000	0001	0010	0011	0100	0101	0110	0111	
0	0000			SP	0	@	P		p	
1	0001			!	1	A	Q	a	q	
2	0010			"	2	B	R	b	r	
3	0011			#	3	C	S	c	s	
4	0100			\$	4	D	T	d	t	
5	0101			%	5	E	U	e	u	
6	0110			&	6	F	V	f	v	
7	0111			'	7	G	W	g	w	
8	1000			(8	H	X	h	x	
9	1001)	9	I	Y	i	y	
A	1010			*	:	J	Z	j	z	
B	1011			+	;	K	[k	{	
C	1100			,	<	L	¥	l		
D	1101			-	=	M]	m	}	
E	1110			.	>	N	^	n	~	
F	1111			/	?	O	_	o	DEL	

Lower 4 bits

Symbols

° C/° F selection 5-33

Numbers

100%AT 3-25

40%AT 3-25

A

A group 6-11

A/D converter error 8-3, 8-5

A/M key 1-4

About Calibration 1-13

About Changing the Number of Steps . 3-22

ABOUT CURRENT

TRANSFORMER (CT) A-5

About Errors That Occur During Motor

Calibration 8-4

About invalid parameters 6-5

About Isolation 2-10

About ON conditions 4-17

About parameter display 5-2

About Pattern Elapsing Time 4-17

About PID Parameters 3-26

About Reset 4-15

About the Alarm Value Decimal Point . 3-16

About the Communications Function . 1-12

About the displays 1-3

About the Order in Which Parameters
are Described in This Chapter 5-2

About the Unit No. 6-15

Advance 4-22, 5-8

Alarm 1 hysteresis 5-29

Alarm 1 open in alarm 5-37

Alarm 1 type 5-36

Alarm 2 hysteresis 5-29

Alarm 2 open in alarm 5-37

Alarm 2 type 5-36

Alarm 3 hysteresis 5-29

Alarm 3 open in alarm 5-37

Alarm 3 type 5-36

Alarm hysteresis 3-11

Alarm type 3-10

Alarm value 3-10, 3-16

Alarm value 1 5-14

Alarm value 2 5-14

Alarm value 3 5-14

Alfa 5-44

Analog input 3-5

ASCII CODE LIST A-15

AT Execute/Cancel 5-18

AT Execution Timing 3-26

Auto-tuning (A.T.) 3-25

Auto-tuning key 1-4

Auto/Manual 4-22

Auxiliary output 2-10

Auxiliary output 1 assignment 5-35

Auxiliary output 2 assignment 5-35

B

B group 6-11

Balance-less, Bump-less Operation .. 3-24

Bar graph 1-3

Basic Operation Flow 3-2

Before setup 2-3, 2-4

C

Cable connections 6-3

Calibrating Current Input 7-9

Calibrating inputs 1-13

Calibrating Platinum Resistance

Thermometers 7-7

Calibrating Thermocouples 7-4

Calibrating transfer output 1-13

Calibrating Voltage Input 7-10

Calibration 7-7, 7-9

Calibration data error 8-4

Calibration item menu 7-3

Calibration Mode 1-10

Calibration: 0 to 10V 7-11

Calibration: 0 to 5V, 1 to 5V 7-10

Calibration: thermocouple 1 7-5

Calibration: thermocouple 2 7-6

Changing currently running programs 3-22

Changing parameters 4-11

Changing the SP 3-22

Changing the time value 3-22

Characteristics A-3

Checking Indication Accuracy 7-12

Checking indication accuracy 7-12

Checking Operation Restrictions 8-6

Close in alarm/open in alarm 3-11

Command Structure 6-5

Commands and Responses 6-7

Communication baud rate 5-48

Communication data length 5-48

Communication parity 5-48

Communication stop bit 5-48

Communication unit No. 5-48

Communications 2-11

Communications parameters 6-4

Conditions when running a program .. 6-17

Connecting the Cold

Junction Compensator 7-4

- CONTROL BLOCK DIAGRAM A-6
- Control output 2-9
- Control output 1 assignment 5-34
- Control output 2 assignment 5-34
- Control period 3-8
- Control period (cool) 5-22
- Control period (heat) 5-22
- Convention Used in this Chapter 3-2
- Conventions Used in this Chapter 5-2
- Cooling coefficient 4-2, 5-19
- CT input/Potentiometer 1-5, 2-10
- Current input 1-5, 7-13
- D**
- Dead band 4-2, 5-19
- Decimal point 5-32
- Derivative time 5-18
- Detailed description of input functions 4-22
- Determining the LBA detection time .. 4-27
- Dimensions 2-5, A-5
- Direct/Reverse operation 3-8, 5-37
- Display range over 8-4
- Down key 1-4
- Draw-out 2-2
- E**
- End code 6-15
- End condition 4-20, 5-40
- Event input 1-6, 2-11
- Event input assignment 1 5-47
- Event input assignment 2 5-47
- Event input assignment 3 5-47
- Event input assignment 4 5-47
- Examples of use 4-25, 6-19
- Executing all patterns 4-14
- Expansion Mode 1-10, 5-38
- F**
- Fixing Screw for Front Panel 2-2
- Fixing settings 1-11
- Front panel 1-2
- H**
- HBA latch 5-50
- HBA latch/release 4-23
- Heater burnout 5-23
- Heater Burnout Alarm A-3
- Heater burnout detection 4-23
- Heater current monitor 5-23
- Heating and cooling control 4-2
- Hold 5-8
- Hold/advance 4-13
- Hold/Hold cancel 4-22
- How the program works 4-12
- How to Calculate FCS 6-6
- How to calculate the
heater burnout set value 4-24
- How to Read Communications
Error Information 6-15
- How to use keys 1-4
- How to use programs 6-17
- How to Use the Error Display 8-3
- How to Use the Error Output 8-5
- How to Use the
Heater Burnout Alarm 4-23
- How to Use Transfer Output 4-28
- Hysteresis 4-5
- Hysteresis (cool) 5-21
- Hysteresis (heat) 5-21
- I**
- Initial Checks 8-2
- Input and Output 1-5
- Input assignments 4-21
- Input digital filter 5-28
- Input error 8-3
- Input errors 8-5
- Input shift lower limit 5-29
- Input shift upper limit 5-29
- Input type 3-4, 5-31
- Installation 2-5
- Integral time 5-18
- Interface 6-2
- Issuing special commands 6-10
- K**
- Key protect 3-19, 5-4
- L**
- LBA 4-26, 8-5
- LBA detection example 4-26
- LBA detection time 4-26, 5-26
- LBA detection width 4-26
- Level 0 Mode 1-9, 5-6
- Level 1 Mode 1-9, 5-17
- Level 2 Mode 1-9, 5-24
- Limiter operation conditions 4-8
- M**
- Main parts 1-2
- Manipulated variable at reset 4-3
- Manipulated variable at reset/PV error . 4-4
- Manipulated variable at stop 3-21
- Manipulated variable restrictions 4-7

- Manual Mode 1-9, 5-5
Manual MV 5-5
Manual reset value 5-20
Memory error 8-3
MODEL LIST A-12
Monitor process value 6-19
Motor calibration 5-50
Mounting 2-6
MV at PV error 5-26
MV at reset 5-26
MV change rate limit 5-27
MV change rate limiter 4-7
MV limiter 4-7
MV lower limit 5-27
MV monitor (cool) 5-10
MV monitor (heat) 5-10
MV upper limit 5-27
- N**
- Names of parts 1-2
No.1 display 1-3
No.2 display 1-3
Number of steps 3-15, 5-12
- O**
- ON/OFF control 4-5
Open/close hysteresis 5-28
Operating Condition Restrictions 4-7
Operating conditions 4-23
Operation at Input Error 4-12
Operation at power ON 4-19, 5-40
Operation indicator LEDs 1-3
Option Mode 1-10, 5-46
Option Unit Ratings and
Characteristics A-4
Other functions 4-4
Outline 6-2
Outline of the Communications
Function 6-2
Output 1-6
Output assignments 1-6, 3-7
Output Unit Ratings and
Characteristics A-4
- P**
- Panel cutout 2-5
Parameter initialize 5-33
PARAMETER OPERATIONS LIST .. A-13
Parameter Structure 7-2
Parameter types 1-9
Parameters and Menus 1-9
- Pattern elapsing time 5-9
Pattern execution count 5-14
Pattern execution count monitor 5-9
Pattern No. 1-3, 3-15, 5-7
Pattern operation 4-14
Pattern select 4-22
PID/ON/OFF 5-39
Platinum resistance thermometer 7-12
Position-proportional control 4-4
Position-proportional type 3-8, 3-24
Position-proportional dead band 5-20
Position-proportional type A-7
Power supply 2-8
Precautions when wiring 2-8
Preparation 7-7, 7-9, 7-10
Preparations 7-4
Preparing for Communications 6-3
Procedure 2-3, 2-4, 6-17
Program 1-8
Program end 4-18
Program Example 6-17
Program example 4-12
Program list 6-18
Program Mode 5-11
Program mode 1-9
Program Operation 4-13
Program output 4-17, 4-18
Program status indicators 1-3
Program structure 4-12
Proportional band 5-18
Protect Mode 1-9, 3-19, 5-3
PV dead band 5-51
PV start 4-20, 5-42
PV/Present SP 5-6
- R**
- Ramp rate 0 5-13
Ramp rate 7 5-13
Ramp Rise Rate Setup Program 4-9
Reading parameters 6-7, 6-12
Reading/writing parameters 6-7
Reading/writing program parameters . 6-12
Registering calibration data 1-13
Relationship with the number of steps . 4-10
Remote/Local 4-22, 5-25
Repeating execution of the
same pattern 4-14
RS-232C 1-12, 6-3
RS-422 1-12, 6-3
RS-485 1-12, 6-4
Run/Reset 4-22

Running the ramp rise
rate setup program 4-11

S

Scaling lower limit 5-32
Scaling upper limit 5-32
Security 3-19, 5-3
Selecting modes 1-10
Selecting parameters 1-11
Selecting the Control Method 4-2
Sensor input 2-9
Sensor Input Setting Ranges
and Indication Ranges A-4
Set point limiter 4-8
Set point lower limit 5-39
Set point upper limit 5-39
Set the set point to "300.0" 6-19
Setting Alarm Type 3-10
Setting Input Specifications 3-4
SETTING LIST A-8
Setting Output Specifications 3-7
Setting Patterns 3-14
Setting Running Conditions 4-19
Setting the communications
specifications 6-4
Setting the LBA detection time 4-27
Setting up the option unit 2-4
Setting up the output unit 2-3
Setting up the terminal covers 2-7
Setup 2-2
Setup examples 3-3
Setup Mode 1-9, 5-30
SPECIFICATIONS A-2
Specifications A-5
Stage output 4-18
Standard type 3-7, 3-24, A-6
Standby operation 4-20
Standby sequence 3-11
Standby time 5-25
Standby time monitor 5-9
Start running 6-19
Starting and Stopping Operation 3-21
Starting the program run 4-20
Step 0 time (Step time) 5-12, 5-13
Step 15 SP (Step time) 5-12
Step 15 time (Step time) 5-13
Step 7 SP (Step time) 5-12
Step 7 time (Step time) 5-13

Step 8 SP (Step time) 5-12
Step 8 time (Step time) 5-13
Step No. monitor 5-7
Step operation 1-8
Step SP/Step time 3-15
Summary of alarm operations 3-12
Switching with Manual Operation 4-3

T

Temperature input 1-5, 3-5
Temperature input shift 3-5
Temperature unit 3-5
Terminal arrangement 2-8
The meaning of icons used
in this chapter 5-2
Thermocouple 7-12
Time signal 4-17
Time signal 1 enabled step 5-15
Time signal 1 OFF time 5-16
Time signal 1 ON time 5-15
Time signal 2 enabled step 5-15
Time signal 2 OFF time 5-16
Time signal 2 ON time 5-15
Time unit of ramp rate 5-42
Transfer output 1-7, 2-11
Transfer output lower limit 5-49
Transfer output scaling 4-28
Transfer output type 4-28, 5-49
Transfer output upper limit 5-49
Transfer procedure 6-2
Travel Time 4-4
Travel time 5-51

U

Undefined error 6-16
Up key 1-4
Using Event Input 3-21

V

Valve opening monitor 4-4, 5-10
Voltage input 1-5, 7-13

W

Wait Operation 4-16
Wait operation 1-8
When the rate of rise is set to "0" 4-10
Wiring 2-8
Wiring Terminals 2-8
Writing parameters 6-7, 6-12

Revision History

A manual revision code appears as a suffix to the catalog number on the front cover of the manual.

Cat. No. H088-E1-02

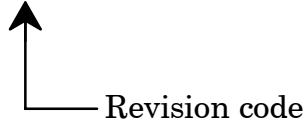

The following table outlines the changes made to the manual during each revision. Page numbers refer to previous version.

Revision code	Date	Revised content
1	September 1997	Original Production
01A	March 2005	Page A-3: Added information to table and accompanying notes
02	June 2010	Page A-9: Changed "%" or "%FS" for hysteresis parameters in the middle of table.

OMRON Corporation Industrial Automation Company

Tokyo, JAPAN

Contact: www.ia.omron.com

Regional Headquarters

OMRON EUROPE B.V.

Wegalaan 67-69-2132 JD Hoofddorp
The Netherlands

Tel: (31)2356-81-300/Fax: (31)2356-81-388

OMRON ELECTRONICS LLC

One Commerce Drive Schaumburg,
IL 60173-5302 U.S.A.

Tel: (1) 847-843-7900/Fax: (1) 847-843-7787

OMRON ASIA PACIFIC PTE. LTD.

No. 438A Alexandra Road # 05-05/08 (Lobby 2),
Alexandra Technopark,
Singapore 119967

Tel: (65) 6835-3011/Fax: (65) 6835-2711

OMRON (CHINA) CO., LTD.

Room 2211, Bank of China Tower,
200 Yin Cheng Zhong Road,
PuDong New Area, Shanghai, 200120, China

Tel: (86) 21-5037-2222/Fax: (86) 21-5037-2200

Authorized Distributor:

© OMRON Corporation 1997 All Rights Reserved.
In the interest of product improvement,
specifications are subject to change without notice.

Printed in Japan

Cat. No. H088-E1-02

0610