Pacific Goal Optronics Limited

SPECIFICATIONS 产品规格书

MODULE NO.(产品型号): PG4319NA-ZA1

Customer Name:

(客户名称)

Customer P/N:

(客户型号)

Data:

(日期)

2021-10-27

Version:

(版本)

V1.0

Customer Approval(客户承认)

Prepare(制作)	Check(审核)	Approval(核准)

Revision History(修订历史)

REV	REVISED DESCRIPTIONS (修订描述)	DATE (日期)
V1.0	Generation first version	2021-10-27

CONTENTS

1. LCD MODULE PHYSICAL DATA	2
2. OUTLINE DIMENSIONS	3
3. ABSOLUTE MAXIMUM RATINGS	4
4. ELECTRICAL CHARACTERISTICS	5
5. ELECTRO-OPTICAL CHARACTERISTICS	6
6. INTERFACE PIN CONNECTIONS	10
7. INITIALIZED CODE	11
8. SPECIFICATION OF QUALITY ASSURANCE	12
9. RELIABILITY	17
10. USING LCD MODULES	18

1 LCD MODULE PHYSICAL DATA

1.1 Features

Display Type	TFT
Viewing Direction	6 O’CLOCK
Connection Type	COG + FPC+BL
Driving IC	ST7282
MPU interface	RGB
Backlight	10 pcs LED

Table 1.

1.2 Mechanical Specification

Item	Standard Value	Unit
Screen size	4.3	inch
Number of dots	480RGB x 272 dots	pixel
LCM dimension	105.5(H) x67.2(V) x2.95(T)	mm
Active area	95.04(H) x53.86(V)	mm
Dot size	--	um
Approx. weight	TBD	g

Table 2.

2 OUTLINE DIMENSIONS

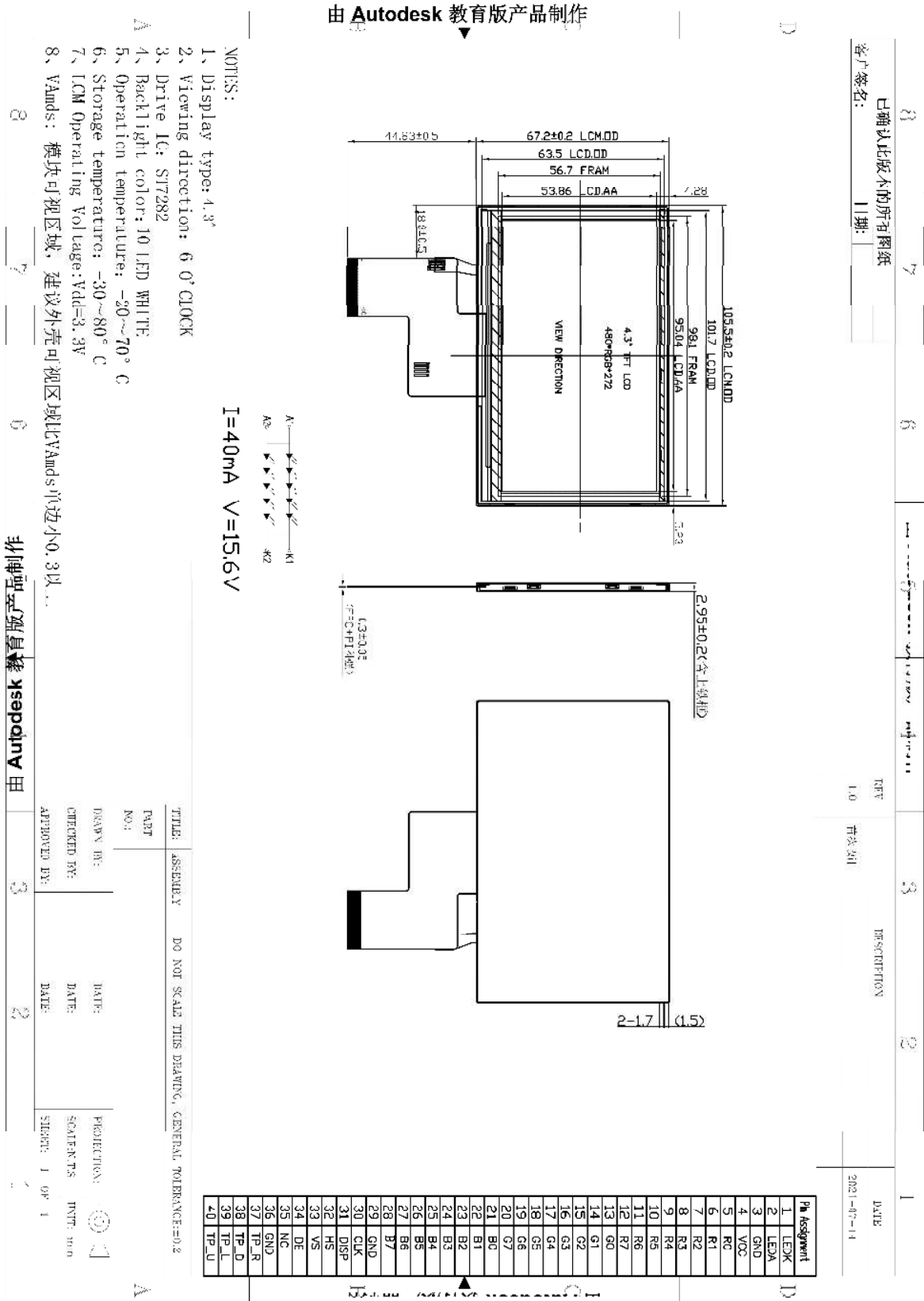

Figure 1.

3 ABSOLUTE MAXIMUM RATINGS

ITEM	SYMBOL	CONDITIO N	STANDARD VALUE			UNIT
			MIN	TYP	MAX	
System Voltage	VDD2.8	Ta= +25°C	-0.3	-	4.6	V
Input Voltage	Vin	Ta=+25°C	-0.3	-	VDD+0.3	V

Table 3.

NOTE:

(1). If the module is used above these absolute maximum ratings. It may become permanently damaged. Using the module within the following electrical characteristic conditions are also exceeded, the module will malfunction and cause poor reliability

(2). LCM should be grounded during handing LCM.

(3). VDD>GND must be maintained.

4 ELECTRICAL CHARACTERISTICS

4.1 DC Characteristics

ITEM	SYMBOL	CONDITIONS	STANDARD VALUE			UNIT
			MIN	TYP	MAX	
System Voltage	VDD	Ta= +25°C	3	3.3	3.6	V
Input High Voltage for LCD	VIH	—	0.7VDD	—	VDD	V
Input Low Voltage for LCD	VIL	—	Vss	—	0.3 VDD	V
Output High Voltage for LCD	VOH	—	VDD-0.4	—	VDD	V
Output Low Voltage for LCD	VOL	—	Vss	—	Vss-0.4	V

Table 4.

4.2 Back-Light unit

PARAMETER	SYMBOL	REMARK	STANDARD VALUE			UNIT
			MIN	TYP	MAX	
FORWARD VOLTAGE	VF	If =40mA	--	15.6	-	V
LUMINOUS INTENSITY	Iv	If =40mA	--	600		cd/m2
LUMINOUS UNIFORMITY	Iv-m	(min/max)/100	-	80	-	%
CHROMATICITY COORDINATES	X	If =40mA	0.260	-	<u>0.330</u>	
	Y		0.260	-	<u>0.330</u>	
OPERATING TEMPERATURE	-20°C ~ 70°C					
STORAGE TEMPERATURE	-30°C ~ 80°C					

Table 5.

4.3 AC Characteristics

Refer to IC data sheet

5 ELECTRO-OPTICAL CHARACTERISTICS

Paramete		Symbol	Condition	Min	Typ	Max	Unit	Remark
Threshold voltage		Vsat		2.7	3.3	3.3	V	Note 1
		Vth		1.2	1.5	1.8	V	
Viewing Angle range	Horizontal	Left(9')	CR > 10	-	70	-	Deg	Not 2
		Right(3')		-	70	-	Deg	
	Vertical	Up(12')		-	50	-	Deg	
		Down(6')		-	70	-	Deg	
Contrast ratio		C/R	$\Theta = 0^\circ$	-	700	-		Not 3
Transmittance		T(%)	$\Theta = 0^\circ$	-	5.2	-		Not 4
White Chromaticity		xw	$\Theta = 0^\circ$	-	0.313	-		Not 5 *Color Filter Glass
		yw		-	0.323	-		
Reproduction Of color	Red	xR	$\Theta = 0^\circ$	-	0.618	-		
		yR		-	0.343	-		
	Green	xG		-	0.306	-		
		yG		-	0.527	-		
	Blue	xB		-	0.139	-		
		yB		-	0.098	-		
Response Time		Tr+Tf	$\Theta = 0^\circ$		30		smec	Not 6

Table 6.

Note :

1. The definition of V_{th} & V_{sat}

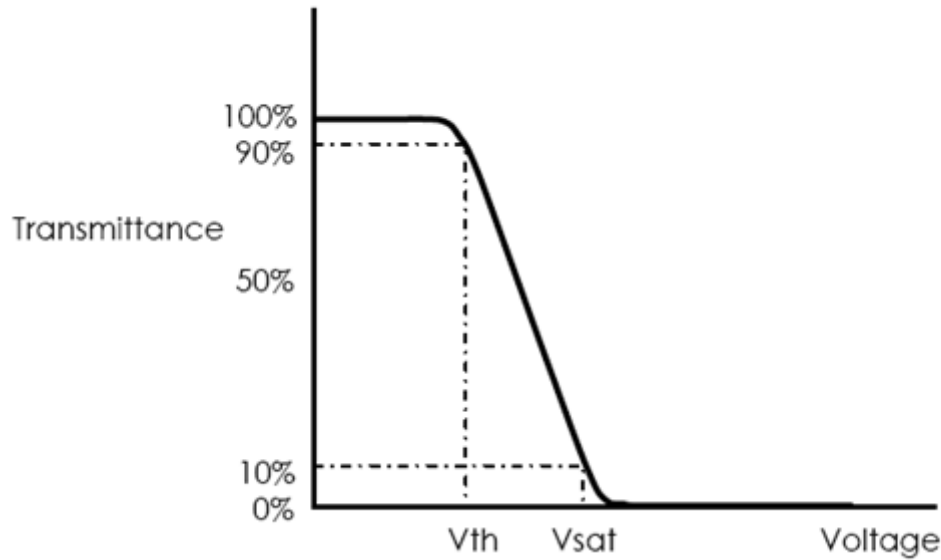

Figure 2. The definition of V_{th} & V_{sat}

6 2. Viewing angle is the angle at which the contrast ratio is greater than 10. The viewing are determined for the horizontal or 3, 9 o'clock direction and the vertical or 6, 12 o'clock direction with respect to the optical axis which is normal to the LCD surface.

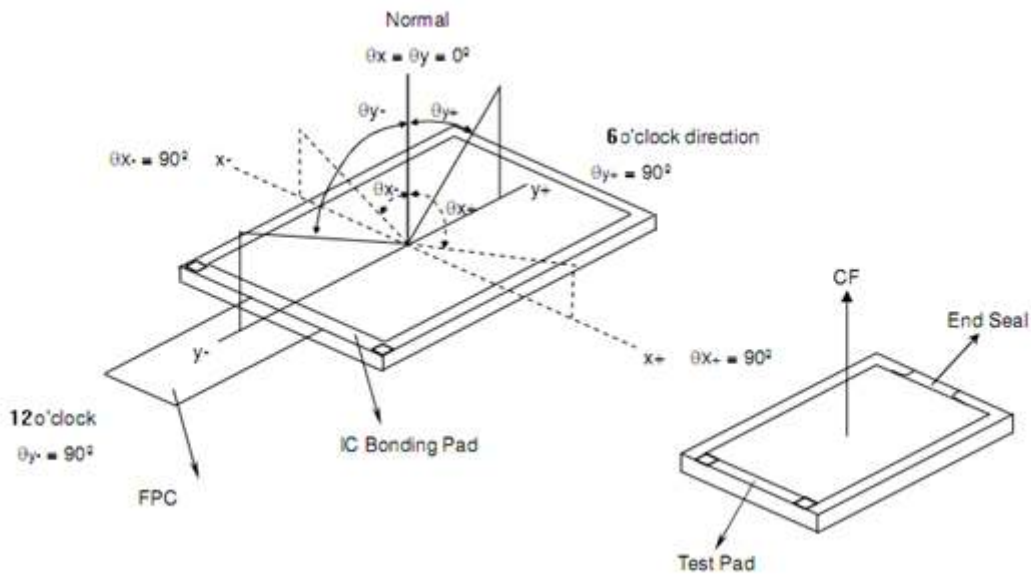

Figure 3. Definition of viewing angle

3. Contrast measurements shall be made at viewing angle of $\Theta = 0^\circ$ and at the center of the LCD surface. Luminance shall be measured with all pixels in the view field set first to white, then to the dark (black) state.

$$CR \square \frac{\text{Luminance when displaying a white raster}}{\text{Luminance when displaying a black raster}}$$

4. Transmittance is the value with Polarizer.

5. The color chromaticity coordinates specified in Table 6. shall be calculated from the spectral data measured with all pixels first in red, green, blue and white. Measurements shall be made at the center of the C/F. Measurement condition is C - light source & Halogen Lamp.

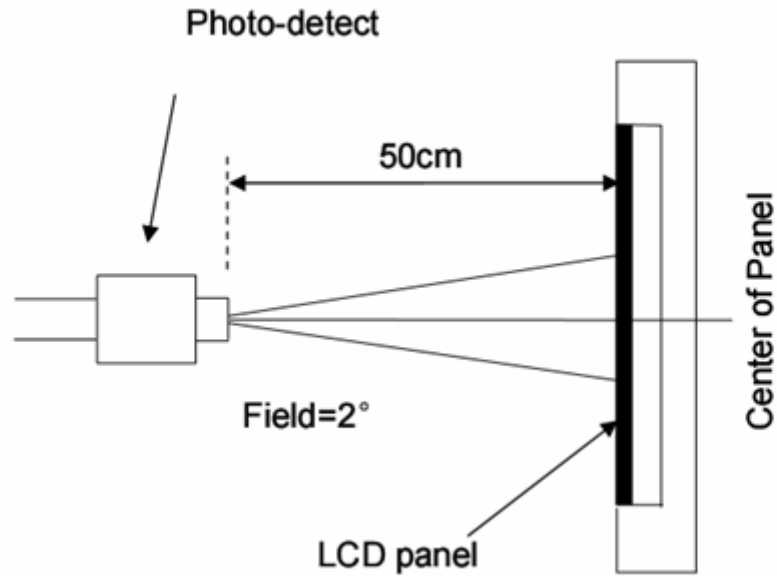

Figure 4 Optical test equipment.

6. The electro-optical response time measurements shall be made as FIGURE 3 shown in Appendix by switching the “data” input signal ON and OFF. The times needed for the luminance to change from 10% to 90% is T_r , and 90% to 10% is T_d

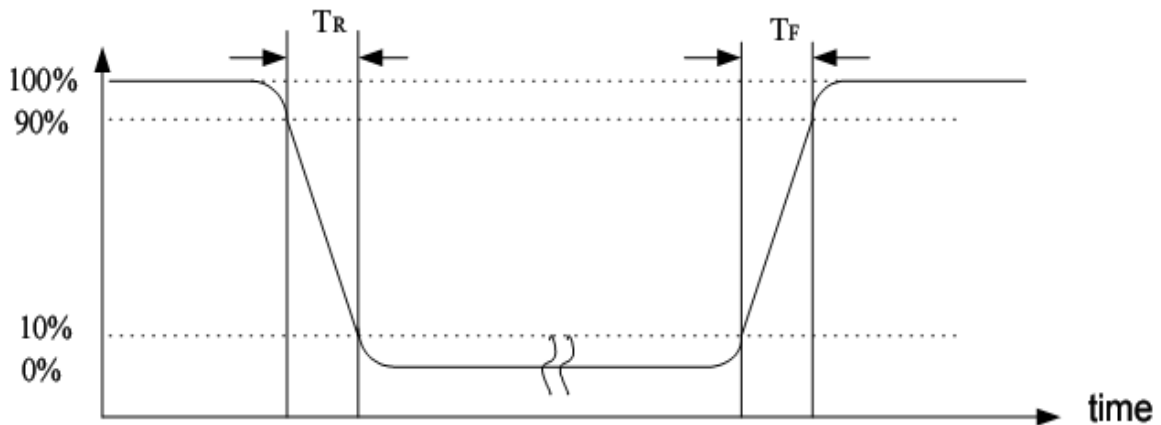

Figure 5. Definition of response time: T_r+T_f

7 INTERFACE PIN CONNECTIONS

PIN NO.	SYMBOL	FUNCTION DESCRIPTIONS
1	LEDK	Backlight negative
2	LEDA	Backlight positive
3	GND	System ground.
4	VDDIO	Power supply for liquid crystal power supply analog circuit.
5~12	R0~R7	Data bus
13~20	G0~G7	Data bus
21~28	B0~B7	Data bus
29	GND	System ground.
30	CLK	Dot clock signal
31	DISP	Display on/off mode control: Low: standby mode. High: normal display mode.
32	HS	Horizontal synchronizing signal.
33	VS	Vertical synchronizing signal.
34	DE	Data ENABLE signal
35	N.C	No Connection.
36	GND	System ground.
37	TP_R	Right electrode – differential analog
38	TP_D	Down electrode – differential analog
39	TP_L	Left electrode – differential analog
40	TP_U	Up electrode – differential analog

Table 7.

8 INITIALIZED CODE

Please contact us for details.

9 SPECIFICATION OF QUALITY ASSURANCE

9.1 Summary

The customer should check and accept the products of PGO within one month after reception. This standard for Quality Assurance should affirm the quality of LCD products to supply to purchaser by PGO. Entire process is controlled according to ISO9001 in factory.

9.2 Standard for quality test

(1) Inspection

Before delivering, the supplier should take the following tests, and affirm the quality of product.

(2) Electro-Optical Characteristics

According to the individual specification to test the product.

(3) Test of Appearance Characteristics:

According to the individual specification to test the product.

(4) Test of Reliability Characteristics

According to the definition of reliability on specification for test product.

(5) Delivery Test

Before delivering, the supplier should take the delivery test

(6) Sampling Method: GB/T2828.1-2003, Level II

(7) The defects classify of AQL as following

Major defect: AQL=0.65

Minor defect: AQL=1.5

9.3 Nonconforming Analysis & Deal With Manners

☆Nonconforming Analysis

(1) Purchaser should supply the detail data of nonconforming sample and the non-suitable state.

(2) After accepting the detail data from purchaser, the analysis of nonconforming should be finished in two weeks.

(3) If supplier can not finish analysis on time, must announce purchaser before two weeks.

☆Disposition of nonconforming

(1) If find any supplier defect during assembly line, supplier must change the good product for every defect after recognition.

(2) Both supplier and customer should analysis the reason and discuss the disposition of nonconforming when the reason of nonconforming is not sure.

9.4 Agreement items.

Both sides should discuss together when the following problems happen:

- (1) There is any problem of standard of quality assurance ,and both sides think that must be modifier.
- (2) There is any argument item which does not record in the quality assurance.
- (3) Any other special problem.

9.5 Standard of the Product Appearance Test

9.5.1 Manner of appearance test

- (1) The test must be under 20W*2 or 40W fluorescent light ,and the distance of view must be at 30 ± 5 cm.
- (2) When test the model of Transmissive product must add the reflective plate.
- (3) Definition of Area:

A Area: Active area

B Area: Viewing area

C Area: Out of viewing area

D Area: Seal area

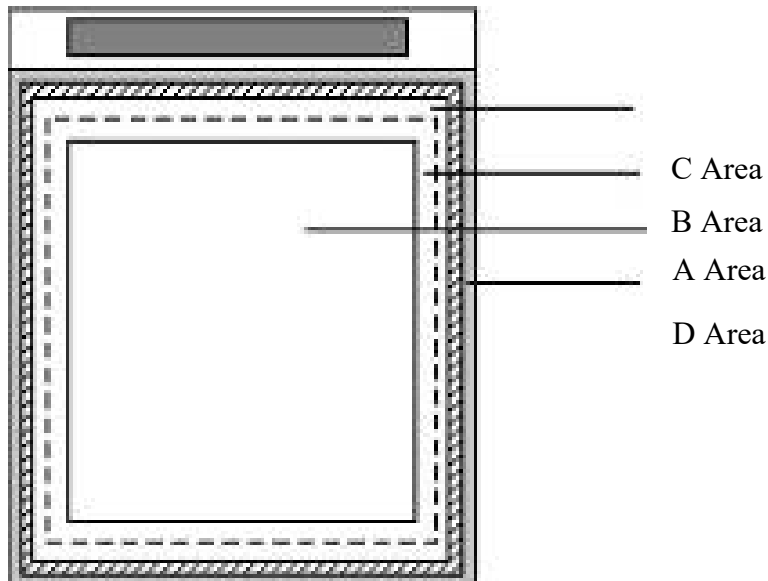

Figure7

9.5.2 Basic principle:

- (1) It will accord to the AQL when the standard can not be described.
- (2) The sample of the lowest acceptable quality level must be discussed by both supplier and customer when any dispute happened.

(3) Must add new item on time when it is necessary.

9.6 Inspection specification

NO	Item	Criterion	AQL
01	Electrical Testing	1.1 Missing vertical, horizontal segment, segment contrast defect. 1.2 Missing character, dot or icon. 1.3 Display malfunction. 1.4 No function or no display. 1.5 Current consumption exceeds product specifications. 1.6 LCD viewing angle defect. 1.7 Contrast defect	0.65

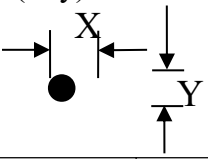
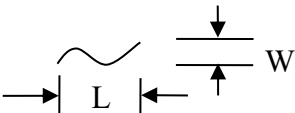
02	LCD black spots, white spots, color spots, contamination, scratches (display/non-display)	<p>2.1 Round type: As following drawing $\phi = (x+y)/2$</p>  <table border="1" data-bbox="526 414 1228 840"> <thead> <tr> <th rowspan="2">Size</th> <th colspan="2">Acceptable QTY</th> <th rowspan="2">Remark</th> </tr> <tr> <th>A.A</th> <th>V.A</th> </tr> </thead> <tbody> <tr> <td>$\phi \leq 0.10$</td> <td>Ignore</td> <td>Ignore</td> <td rowspan="5">No more than two spots within 5mm</td> </tr> <tr> <td>$0.10 < \phi \leq 0.15$</td> <td>2</td> <td>3</td> </tr> <tr> <td>$0.15 < \phi \leq 0.20$</td> <td>1</td> <td>2</td> </tr> <tr> <td>$0.20 < \phi$</td> <td>0</td> <td>0</td> </tr> <tr> <td>Total</td> <td>3</td> <td>5</td> </tr> </tbody> </table> <p>2.2 Line Type: (As following drawing)</p>  <table border="1" data-bbox="526 1052 1273 1366"> <thead> <tr> <th rowspan="2">Length</th> <th rowspan="2">Width</th> <th colspan="2">Acceptable QTY</th> <th rowspan="2">Remark</th> </tr> <tr> <th>A.A</th> <th>V.A</th> </tr> </thead> <tbody> <tr> <td>---</td> <td>$W \leq 0.03$</td> <td>Ignore</td> <td>Ignore</td> <td rowspan="3">No more than two lines within 5mm</td> </tr> <tr> <td>$L \leq 2.5$</td> <td>$0.03 < W \leq 0.05$</td> <td rowspan="2">2</td> <td rowspan="2">3</td> </tr> <tr> <td>$L \leq 1.5$</td> <td>$0.05 < W \leq 0.08$</td> </tr> <tr> <td>---</td> <td>$0.08 < W$</td> <td>0</td> <td>0</td> <td></td> </tr> </tbody> </table>	Size	Acceptable QTY		Remark	A.A	V.A	$\phi \leq 0.10$	Ignore	Ignore	No more than two spots within 5mm	$0.10 < \phi \leq 0.15$	2	3	$0.15 < \phi \leq 0.20$	1	2	$0.20 < \phi$	0	0	Total	3	5	Length	Width	Acceptable QTY		Remark	A.A	V.A	---	$W \leq 0.03$	Ignore	Ignore	No more than two lines within 5mm	$L \leq 2.5$	$0.03 < W \leq 0.05$	2	3	$L \leq 1.5$	$0.05 < W \leq 0.08$	---	$0.08 < W$	0	0		1.5
Size	Acceptable QTY			Remark																																												
	A.A	V.A																																														
$\phi \leq 0.10$	Ignore	Ignore	No more than two spots within 5mm																																													
$0.10 < \phi \leq 0.15$	2	3																																														
$0.15 < \phi \leq 0.20$	1	2																																														
$0.20 < \phi$	0	0																																														
Total	3	5																																														
Length	Width	Acceptable QTY		Remark																																												
		A.A	V.A																																													
---	$W \leq 0.03$	Ignore	Ignore	No more than two lines within 5mm																																												
$L \leq 2.5$	$0.03 < W \leq 0.05$	2	3																																													
$L \leq 1.5$	$0.05 < W \leq 0.08$																																															
---	$0.08 < W$	0	0																																													
03	Polarizer bubbles Ignore	<p>If bubbles are visible, judge using black spot specification, not easy to find, must check in specify direction.</p> <table border="1" data-bbox="526 1534 1181 1747"> <thead> <tr> <th rowspan="2">Size</th> <th colspan="2">Acceptable QTY</th> </tr> <tr> <th>A. A</th> <th>V. A</th> </tr> </thead> <tbody> <tr> <td>$\phi \leq 0.15$</td> <td>Ignore</td> <td>Ignore</td> </tr> <tr> <td>$0.15 < \phi \leq 0.2$</td> <td>2</td> <td>3</td> </tr> <tr> <td></td> <td>0</td> <td>0</td> </tr> </tbody> </table>	Size	Acceptable QTY		A. A	V. A	$\phi \leq 0.15$	Ignore	Ignore	$0.15 < \phi \leq 0.2$	2	3		0	0	1.5																															
Size	Acceptable QTY																																															
	A. A	V. A																																														
$\phi \leq 0.15$	Ignore	Ignore																																														
$0.15 < \phi \leq 0.2$	2	3																																														
	0	0																																														

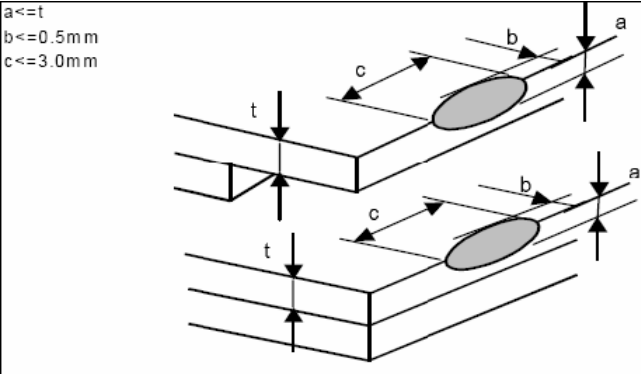
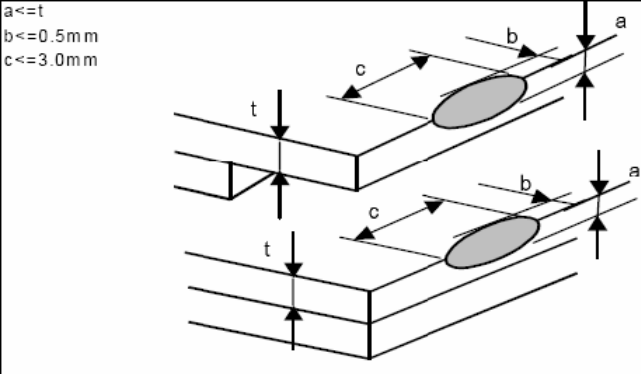
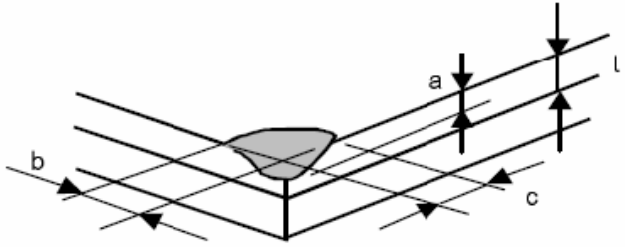
04	Chipped glass	<p>Symbols: a: Chip length b: Chip width c: Chip thickness t: Glass thickness</p> <p>4.1 ITO electrode</p>  <p>$a \leq t$ $b \leq 0.5\text{mm}$ $c \leq 3.0\text{mm}$</p> <p>*Effective width of seal area shall be more than 0.3mm.</p> <p>4.2 General ,corner portion</p>  <p>$a \leq t$ $b \leq 0.5\text{mm}$ $c \leq 3.0\text{mm}$</p> <p>*Effective width of seal area shall be more than 0.3mm.</p> 	1.5
----	---------------	---	-----

05	Cracked glass	The LCD with extensive crack is not acceptable.	0.65
06	Backlight elements	<p>6.1 Illumination source flickers when lit.</p> <p>6.2 Spots or scratches that appear when lit must be judged using LCD spot, lines and contamination standards.</p> <p>6.3 Backlight doesn't light or color is wrong</p>	<p>0.65</p> <p>1.5</p> <p>0.65</p>

07	Soldering	<p>7.1 No unmelted solder paste may be present on the PCB. 1.5</p> <p>7.2 No cold solder joints, missing solder connections, oxidation or icicle. 1.5</p> <p>7.3 No residue or solder balls on PCB. 1.5</p> <p>7.4 No short circuits in components on PCB. 0.65</p>	
08	General appearance	<p>8.1 No oxidation, contamination, curves or, bends on interface pin (OLB) of TCP. 1.5</p> <p>8.2 No cracks on interface pin(OLB) of TCP 0.65</p> <p>8.3 NO contamination, solder residue or solder balls on product. 1.5</p> <p>8.4 The IC on the TCP may not be damaged, circuits. 0.65</p> <p>8.5 The residual rosin or tin oil of soldering (component or chip component) is not burned into brown or black color. 8.6 1.5</p> <p>Sealant on top of the ITO circuit has not hardened 1.5</p> <p>8.7 Pin type must match type in specification sheet. 0.65</p> <p>8.8 LCD pin loose or missing pins. 0.65</p> <p>8.9 Product packaging must the same as specified on packaging specification sheet. 0.65</p> <p>8.10 Product dimension and structure must conform to product specification sheet. 0.65</p>	

Table 8.

NO..	Test Item	Description	Test Condition
1	High temperature storage	Endurance test applying the high storage temperature for a long time	80°C,24 H
2	Low temperature storage	Endurance test applying the low storage temperature for a long time	-30°C,24H
3	High temperature operation	Endurance test applying the electric stress under high temperature for a long time	70°C,24H
4	Low temperature operation	Endurance test applying the electric stress under low temperature for a long time	-20°C,24H
5	High temperature /humidity storage	Endurance test applying the high temperature and high humidity storage for a long time	60°C, 90% R.H 24H
6	High temperature /humidity operation	Endurance test applying electric stress under high temperature and high humidity for a long time	40°C 90% R.H 24H
7	Temperature Cycle	Endurance test applying the low and high temperature cycle -20°C → 25°C → 70°C →25°C 30min 5min 30min 5min one cycle	-20°C/70°C 10 cycles
8	Vibration test	Endurance test applying the vibration during transportation and using	10Hz~50Hz Swing:0.75mm time:30min
9	Fall test	Endurance test dropping the LCM from a high place	600mm height
10	Static electricity test	Endurance test applying static electric stress to terminal	Contact discharge: ±2KV~4KV Air discharge: ±2KV~8KV

Table 9.

NOTE: TEST CONDITION

- (1) Temperature and humidity: If no specification, temp. set at 25±2°C, humidity set at 60±5%RH.
- (2) Operating state: Samples subject to the test shall be in “operating” condition.

11 USING LCD MODULES

11.1 LIQUID CRYSTAL DISPLAY MODULES

LCD is composed of glass and polarizer. Pay attention to the following items when handling.

- (1) Please keep the temperature within specified range for use and storage. Polarization degradation, bubble generation or polarizer peel-off may occur with high temperature and high humidity.
- (2) Do not touch, push or rub the exposed polarizers with anything harder than an HB pencil lead (glass, tweezers, etc.).
- (3) N-hexane is recommended for cleaning the adhesives used to attach front/rear polarizers and reflectors made of organic substances which will be damaged by chemicals such as acetone, toluene, ethanol and isopropylalcohol.
- (4) When the display surface becomes dusty, wipe gently with absorbent cotton or other soft material like chamois soaked in petroleum benzine. Do not scrub hard to avoid damaging the display surface.
- (5) Wipe off saliva or water drops immediately, contact with water over a long period of time may cause deformation or color fading.
- (6) Avoid contacting oil and fats.
- (7) Condensation on the surface and contact with terminals due to cold will damage, stain or dirty the polarizers. After products are tested at low temperature they must be warmed up in a container before coming in contact with room temperature air.
- (8) Do not put or attach anything on the display area to avoid leaving marks on.
- (9) Do not touch the display with bare hands. This will stain the display area and degrade insulation between terminals (some cosmetics are determined to the polarizers).
- (10) As glass is fragile. It tends to become or chipped during handling especially on the edges. Please avoid dropping or rising.

11.2 PRECAUTION FOR HANDLING LCD MODULES

Since LCM has been assembled and adjusted with a high degree of precision, avoid applying excessive shocks to the module or making any alterations or modifications to it.

- (1) Do not alter, modify or change the the shape of the tab on the metal frame.
- (2) Do not make extra holes on the printed circuit board, modify its shape or change the positions of components to be attached.
- (3) Do not damage or modify the pattern writing on the printed circuit board.
- (4) Absolutely do not modify the zebra rubber strip (conductive rubber) or heat seal connector.
- (5) Except for soldering the interface, do not make any alterations or modifications with a soldering iron.

(6) Do not drop, bend or twist LCM.

(7) In order to avoid the cracking of the FPC, you should pay attention to the area of FPC(R50mm) where the FPC was bent. the edge of coverlay; the area of surface of Ni-Au plating, the area of soldering land, the area of through hole.

11.3 ELECTRO-STATIC DISCHARGE CONTROL

Since this module uses a CMOS LSI, the same careful attention should be paid to electrostatic discharge as for an ordinary CMOS IC.

(1) Make certain that you are grounded when handling LCM.

(2) Before remove LCM from its packing case or incorporating it into a set, be sure the module and your body have the same electric potential.

(3) When soldering the terminal of LCM, make certain the AC power source for the soldering iron does not leak.

(4) When using an electric screwdriver to attach LCM, the screwdriver should be of ground potentiality to minimize as much as possible any transmission of electromagnetic waves produced sparks coming from the commutator of the motor.

(5) As far as possible make the electric potential of your work clothes and that of the work bench the ground potential.

(6) To reduce the generation of static electricity be careful that the air in the work is not too dried. A relative humidity of 0%-60% is recommended.

11.4 PRECAUTIONS FOR OPERATION

(1) Viewing angle varies with the change of liquid crystal driving voltage (VO). Adjust VO to show the best contrast.

(2) Driving the LCD in the voltage above the limit shortens its life.

(3) Response time is greatly delayed at temperature below the operating temperature range. However, this does not mean the LCD will be out of the order. It will recover when it returns to the specified temperature range.

(4) If the display area is pushed hard during operation, the display will become abnormal. However, it will return to normal if it is turned off and then back on.

(5) Condensation on terminals can cause an electrochemical reaction disrupting the terminal circuit. Therefore, it must be used under the relative condition of 40°C , 50% RH.

(6) When turning the power on, input each signal after the positive/negative voltage becomes stable.

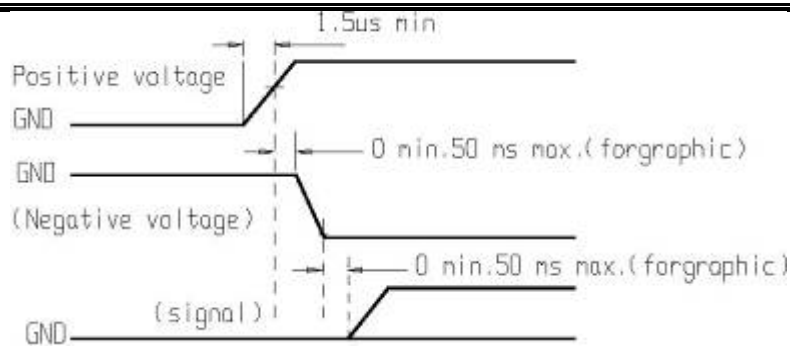

Figure 8.

11.5 STORAGE

When storing LCDs as spares for some years, the following precaution are necessary.

- (1) Store them in a sealed polyethylene bag. If properly sealed, there is no need for dessicant.
- (2) Store them in a dark place. Do not expose to sunlight or fluorescent light, keep the temperature between 0°C and 35°C.
- (3) The polarizer surface should not come in contact with any other objects. (We advise you to store them in the container in which they were shipped.)
- (4) Environmental conditions :
 - Do not leave them for more than 160hrs. at 70°C.
 - Should not be left for more than 48hrs. at -20°C.

11.6 SAFETY

- (1) It is recommended to crush damaged or unnecessary LCDs into pieces and wash them off with solvents such as acetone and ethanol, which should later be burned.
- (2) If any liquid leaks out of a damaged glass cell and comes in contact with the hands, wash off thoroughly with soap and ater.

11.7 LIMITED WARRANTY

Unless agreed between PGO and customer, PGO will replace or repair any of its LCD modules which are found to be functionally defective when inspected in accordance with PGO LCD modules acceptance standards (copies available upon request) for a period of one year from date of shipments. Cosmetic/visual defects must be returned to PGO within 90 days of shipment. Confirmation of such date shall be based on freight documents. The warranty liability of PGO limited to repair and/or replacement on the terms set forth above. PGO will not be responsible for any subsequent or consequential events.

11.8 RETURN LCM UNDER WARRANTY

No warranty can be granted if the precautions stated above have been disregarded. The typical examples of violations are :

- Broken LCD glass.
- Circuit modified in any way, including addition of components.

Module repairs will be invoiced to the customer upon mutual agreement. Modules must be returned with sufficient description of the failures or defects. Any connectors or cable installed by the customer must be removed completely without damaging the PCB's eyelet, conductors and terminals.

12. 包装方式 (PACKING MODE) 仅供参考详情下单后再定

1 包装规范

1.1 装箱办法见《包装方法示意图》。装箱数量则由每一个吸塑盘所装的数量决定。每箱装一叠吸塑，

每叠 11 个吸塑盘，上面一个吸塑盘不装产品，交叉层叠放置，上下需用纸板、胶纸固定。

1.2 小箱：材料为 K3K，外腔尺寸为 485*355*130mm。

1.3 吸塑盘：PET 透防静电或着 PS 黑防静电材料，厚度为 0.6MIN，外形尺寸（根据背光供应商提供吸塑盘尺寸为准），用量为每箱 11Pcs。

1.4 纸板：材料为 A-A 瓦楞纸板，用量为每箱 2Pcs。

1.5 装箱数量的计算：

每个吸塑盒所装数量*10（层）

每个吸塑盘装产品数量 10，每箱的装箱数量为：10*10=100（Pcs）产品。

小箱包装示意图：

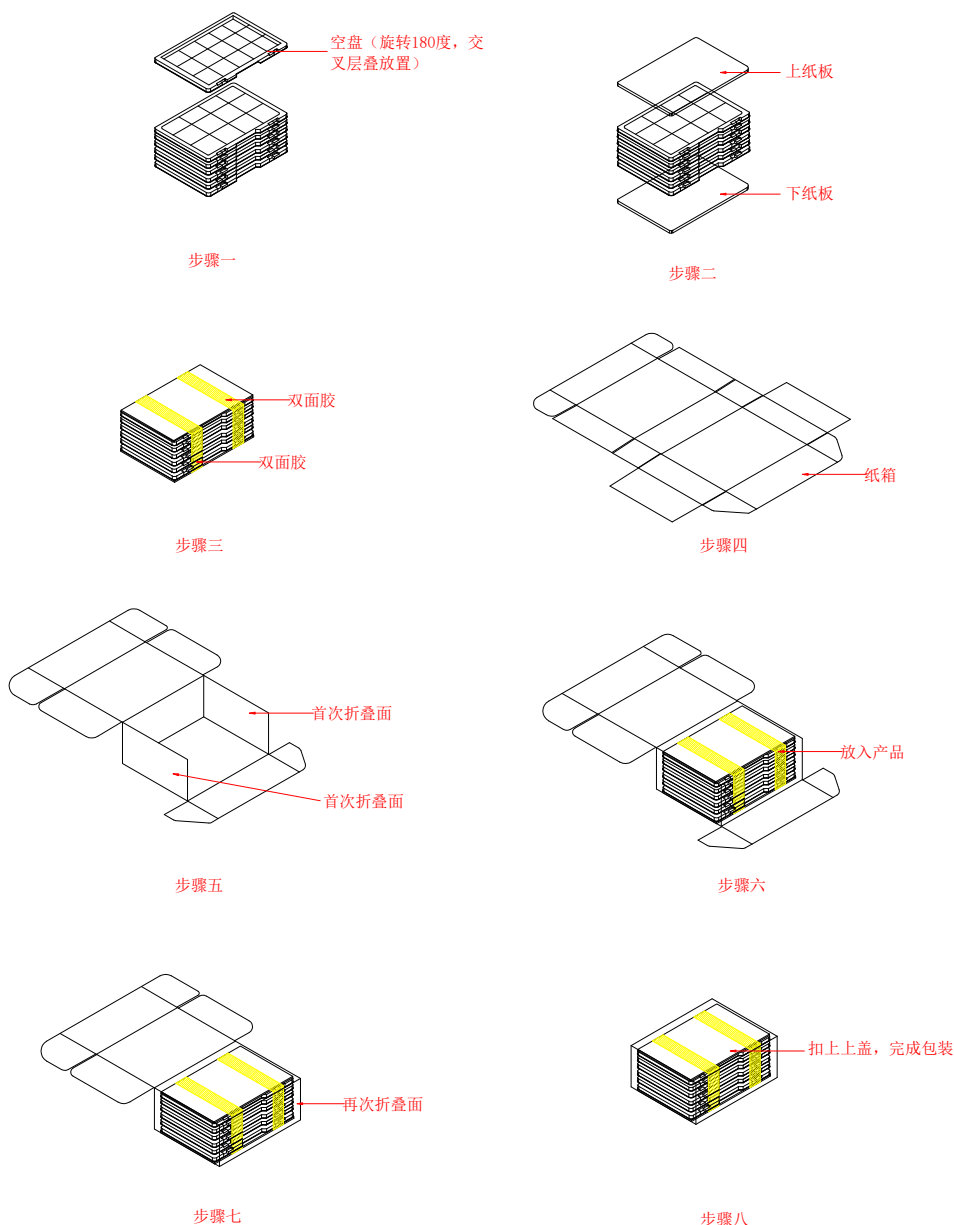

2 按产品型号及物料编号贴上标签及盖上 PASS 章

正常情况下,使用统一的标签。部分产品有写上客户的型号或物料编号按“产品型号及客户物料对应表”进行填写。特殊专用的产品标签及出港或走快递的产品，包装标签按跟单人员提供的进行标明。

3 出港及走快递的产品，需要外箱

出港及走快递的产品建议用大小箱包装，即两个小箱加外箱。（如图）

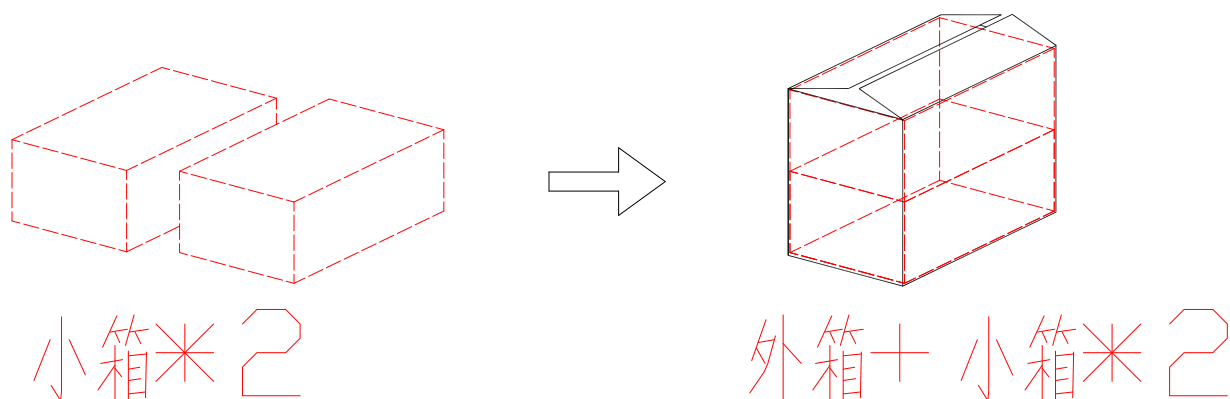

NO.	Item	Dimensions	Quantity	Remark
1	TRAY	One tray	10	
2	SMALL CARTON	One carton/11 tray	100	
3	LARGE CARTON	One carton/2 small carton	200	

4 打包作业流程图

