

FEATURES

- Fully compliant with SCSI-1, Fast SCSI and Ultra SCSI
- Backward compatible to the DS2107, DS2107A, and DS21S07
- Provides active termination for nine signal lines
- Laser-trimmed 110 ohms termination resistors have 2% tolerance
- Low dropout voltage regulator
- Power-down mode isolates termination resistors from the bus
- SCSI bus hot-plug compatible
- Fully supports actively negated SCSI signals
- Onboard thermal shutdown circuitry
- 16-pin plastic SOIC (DS21T07S) and 20-pin plastic TSSOP (Thin Shrink Small Outline Package) (DS21T07E)

PIN ASSIGNMENT

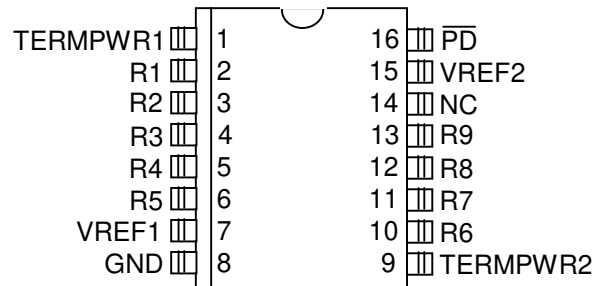

DS21T07S 16-pin SOIC (300-mil)

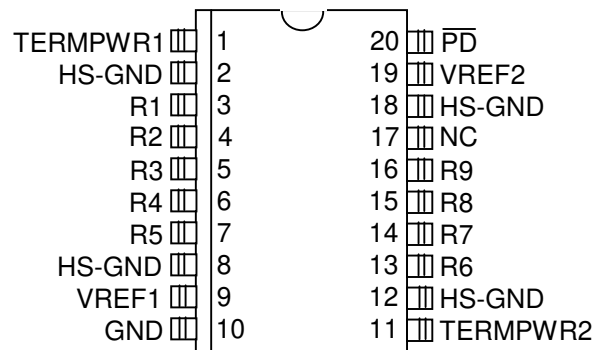

DS21T07E 20-pin TSSOP (173-mil)

ACTUAL FOOTPRINT SIZE

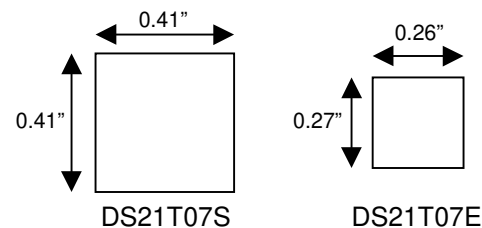

DESCRIPTION

Fast SCSI and Ultra SCSI require the use of active terminations at both ends of every cable segment in a SCSI system with single-ended drivers and receivers. The DS21T07 SCSI Terminator, which is fully compliant with these standards, enables the designer to gain the benefits of active termination: greater immunity to voltage drops on the TERMPWR (TERMination PoWeR) line, enhanced high-level noise immunity, intrinsic TERMPWR decoupling, and very low quiescent current consumption. The DS21T07 integrates a regulator and nine precise switched 110 ohms termination resistors into a monolithic IC. The DS21T07 can be electrically isolated from the SCSI bus without physical removal from the SCSI device.

FUNCTIONAL DESCRIPTION

The DS21T07 consists of a bandgap reference, buffer amplifier, and nine termination resistors (Figure 1). The bandgap reference circuit produces a precise 2.55V level which is fed to a buffer amplifier. The buffer produces a 2.85V level and is capable of sourcing at least 24 mA into each of the termination resistors when the signal line is low (active). When the driver for a given signal line turns off, the terminator will pull the signal line to 2.85V (quiescent state). To handle actively negated SCSI signals, the buffer can sink at least 200 mA, and V_{REF} will move less than 60 mV. When all lines settle in the quiescent state, the regulator will consume about 5 mA. When the DS21T07 is put into power-down mode by bringing \overline{PD} low, the power-down circuitry will turn off the transistors on each signal line. This will isolate the DS21T07 from the signal lines and effectively remove it from the circuit. The power-down pin (\overline{PD}) has an internal 50K Ω pullup resistor. To place the DS21T07 into an active state, the \overline{PD} pin should be left open circuited. When installed on disk drives or RAID system components, the DS21T07 will not affect the SCSI bus during a hot plug operation.

To ensure proper operation, both the TERMPWR1 and TERMPWR2 pins must be connected to the SCSI bus TERMPWR line and both the VREF1 and VREF2 pins must be tied together externally. Each DS21T07 requires a 4.7 μ F capacitor connected between the VREF pins and ground. Figure 2 details a typical SCSI bus configuration. In an 8-bit wide SCSI bus arrangement, two DS21T07's would be needed at each end of the SCSI cable in order to terminate the 18 active signal lines. In a 16-bit wide SCSI bus arrangement, three DS21T07's would be needed at each end of the SCSI cable in order to terminate the 27 active signal lines.

DS21T16 BLOCK DIAGRAM Figure 1

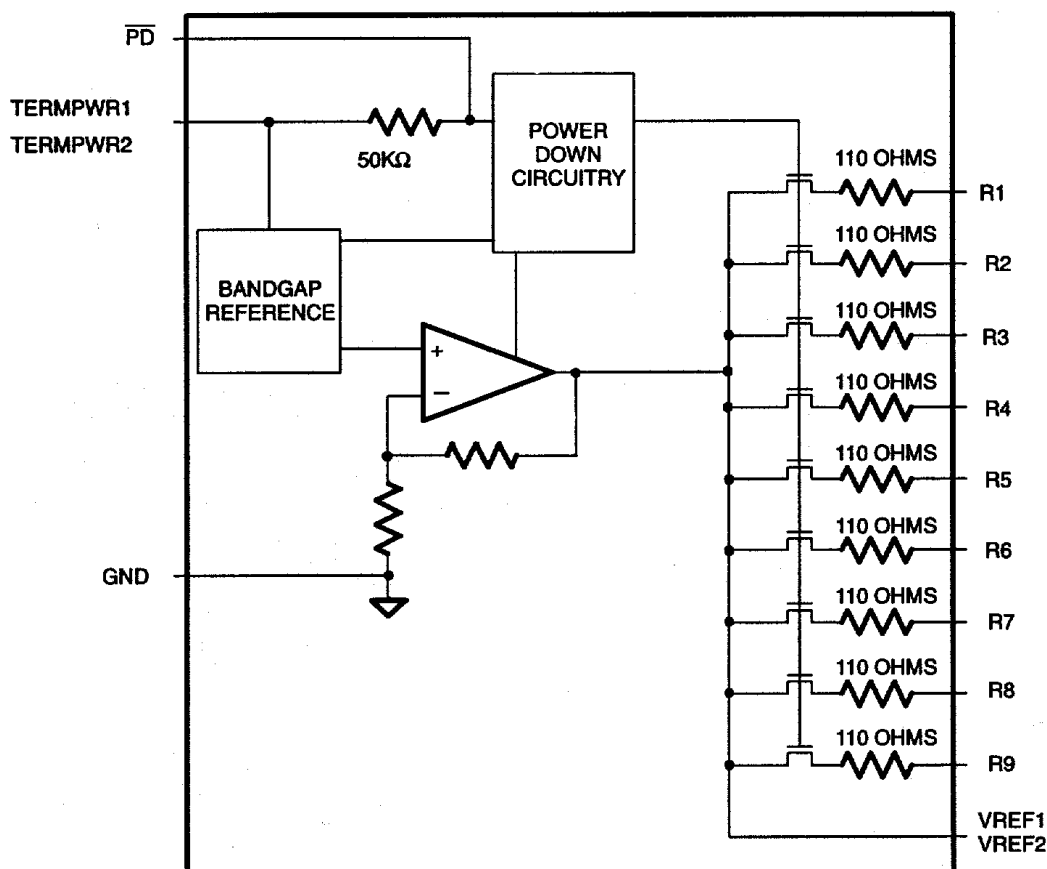

TYPICAL SCSI BUS CONFIGURATION Figure 2

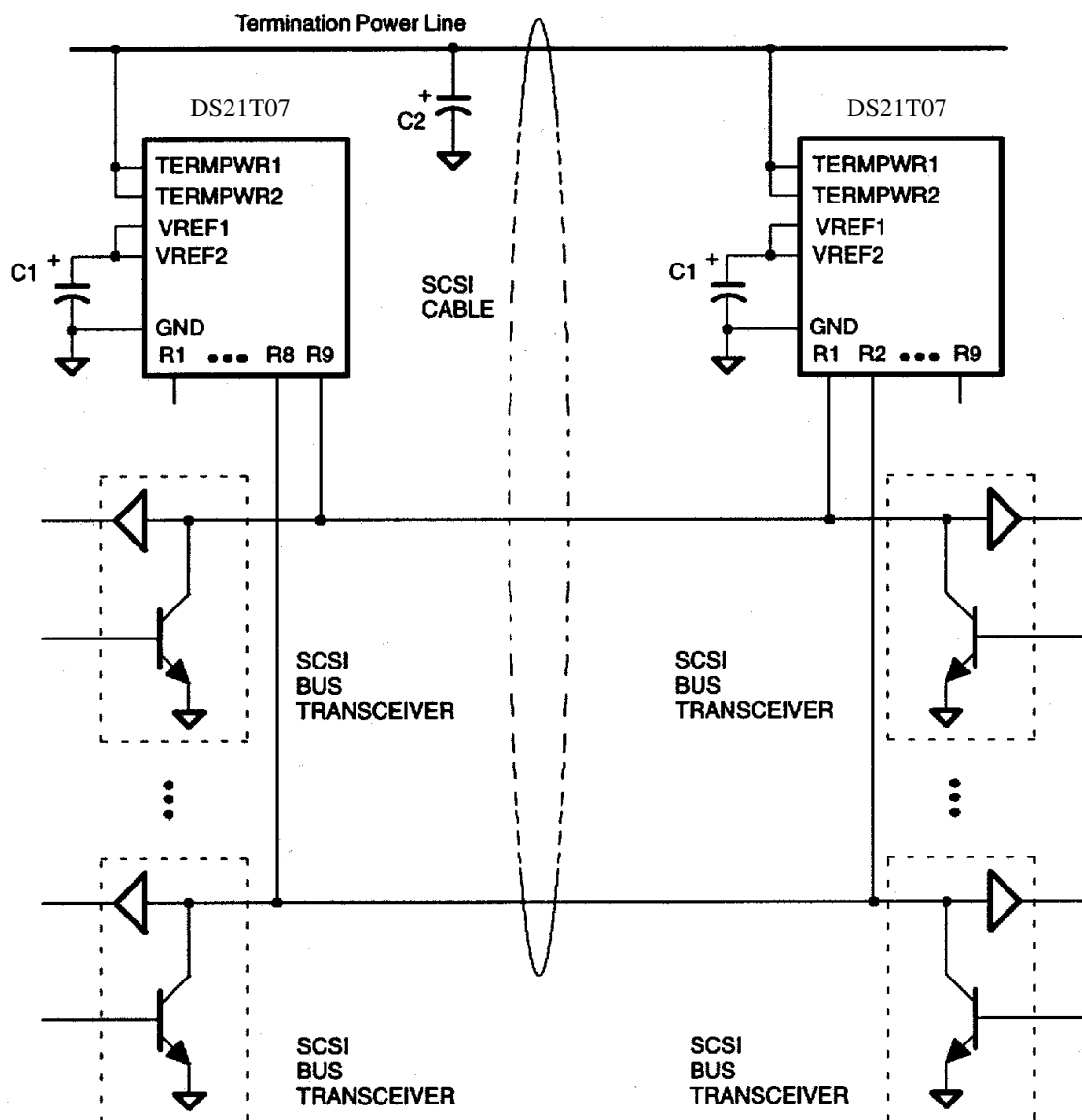

NOTES:

1. C1 = 4.7 μF tantalum
C2 = 2.2 μF tantalum or 4.7 μF aluminum
2. If the DS21T07 is to be embedded into a peripheral that will act as a target on a SCSI bus, it is that recommended TERMPWR be derived from the SCSI cable, not generated locally. In this configuration, if a power failure occurs in the peripheral, it will not affect the bus.
3. A high frequency bypass capacitor (0.1 μF recommended) can be added in parallel to C1 for applications using fast rise/fall time drivers.

PIN DESCRIPTION Table 1

| DS21T16E PIN | DS21T16S PIN | SYMBOL | DESCRIPTION |
|-----------------|-----------------|------------------------|---------------------------------------------------------------------------------------------------------------------------------------------------------------------------------------------|
| 1 | 1 | TERMPWR1 | Termination Power 1. Should be connected to the SCSI TERMPWR line. Must be decoupled with either a 2.2 μ F or 4.7 μ F. See Figure 2. |
| 3 | 2 | R1 | Signal Termination 1. 110 ohms termination. |
| 4 | 3 | R2 | Signal Termination 2. 110 ohms termination. |
| 5 | 4 | R3 | Signal Termination 3. 110 ohms termination. |
| 6 | 5 | R4 | Signal Termination 4. 110 ohms termination. |
| 7 | 6 | R5 | Signal Termination 5. 110 ohms termination. |
| 9 | 7 | VREF1 | Reference Voltage 1. Must be externally connected directly to the VREF2 pin. Must be decoupled with a 4.7 μ F capacitor as shown in Figure 2. |
| 10 | 8 | GND | Ground. Signal ground; 0.0V. |
| 11 | 9 | TERMPWR2 | Termination Power 2. Should be connected to the SCSI TERMPWR line. Must be decoupled with either a 2.2 μ F or 4.7 μ F. See Figure 2. |
| 13 | 10 | R6 | Signal Termination 6. 110 ohms termination. |
| 14 | 11 | R7 | Signal Termination 7. 110 ohms termination. |
| 15 | 12 | R8 | Signal Termination 8. 110 ohms termination. |
| 16 | 13 | R9 | Signal Termination 9. 110 ohms termination. |
| 17 | 14 | NC | No Connect. Do not connect any signal to this pin. |
| 19 | 15 | VREF2 | Reference Voltage 2. Must be externally connected directly to the VREF1 pin. Must be decoupled with a 4.7 μ F capacitor as shown in Figure 2. |
| 20 | 16 | $\overline{\text{PD}}$ | Power Down. When tied low, the DS21T07 enters a power-down mode. Contains an internal 50K pullup. Strap low to deactivate the DS21T07, leave open circuited to activate the DS21T07. |
| 2, 8, 12, 18 | N/A | HS-GND | Heat Sink Ground. Internally connected to the mounting pad. Should be either grounded or electrically isolated from other circuitry. |

ABSOLUTE MAXIMUM RATINGS*

| | |
|---------------------------------------|----------------------|
| Voltage on Any Pin Relative to Ground | -1.0V to +7.0V |
| Operating Temperature | 0°C to 70°C |
| Storage Temperature | -55°C to +125°C |
| Soldering Temperature | 260°C for 10 seconds |

* This is a stress rating only and functional operation of the device at these or any other conditions above those indicated in the operation sections of this specification is not implied. Exposure to absolute maximum rating conditions for extended periods of time may affect reliability.

The Dallas Semiconductor DS21T07 is built to the highest quality standards and manufactured for long-term reliability. All Dallas Semiconductor devices are made using the same quality materials and manufacturing methods. However, the DS21T07 is not exposed to environmental stresses, such as burn-in, that some industrial applications require. For specific reliability information on this product, please contact the factory in Dallas at (972) 371-4448.

RECOMMENDED OPERATING CONDITIONS (0°C to 70°C)

| PARAMETER | SYM | MIN | TYP | MAX | UNITS | NOTES |
|---------------------------------|-----------|------|-----|----------------|-------|-------|
| TERMPWR Voltage | V_{TP} | 4.00 | | 5.50 | V | |
| $\overline{\text{PD}}$ Active | V_{PDA} | -0.3 | | +0.8 | V | |
| $\overline{\text{PD}}$ Inactive | V_{PDI} | 2.0 | | $V_{TP} + 0.3$ | V | |

DC CHARACTERISTICS (0°C to 70°C)

| PARAMETER | SYMBOL | MIN | TYP | MAX | UNITS | NOTES |
|------------------------------------|------------|------|-----|-----|---------------|------------|
| TERMPWR Current | I_{TP} | | | 250 | mA | 1, 3 |
| | I_{TP} | | 5 | 8 | mA | 1, 4 |
| Power-Down Current | I_{PD} | | 100 | 150 | μA | 1, 2, 5 |
| Termination Resistance | R_{TERM} | 108 | 110 | 112 | ohms | 1, 2 |
| Die Thermal Shutdown | T_{SD} | 150 | 150 | | °C | 1, 6 |
| Power-Down Termination Capacitance | C_{PD} | | | 3.0 | pF | 1, 2, 5, 6 |
| Input Leakage High | I_{IH} | -1.0 | | | μA | 1, 8 |
| Input Leakage Low | I_{IL} | | | 1.0 | μA | 1, 7 |

REGULATOR CHARACTERISTICS (0°C to 70°C)

| PARAMETER | SYMBOL | MIN | TYP | MAX | UNITS | NOTES |
|------------------|------------|------|------|------|-------|-------|
| Output Voltage | V_{REF} | 2.79 | 2.85 | 2.93 | V | 1, 2 |
| Drop Out Voltage | V_{DROP} | | 0.50 | 0.75 | V | 3, 6 |
| Output Current | I_{OUT} | | | 25.2 | mA | 9 |
| Line Regulation | LI_{REG} | | 1.0 | 2.0 | % | 1, 4 |
| Load Regulation | LO_{REG} | | 1.3 | 3.0 | % | 1, 3 |
| Current Limit | I_{LIM} | | 350 | | mA | 1 |
| Sink Current | I_{SINK} | 200 | | | mA | 1 |

NOTES:

1. $4.00V < \text{TERMPWR} < 5.50V$.
2. $0.0V < \text{signal lines} < 3.0V$.
3. All signal lines = $0.0V$.
4. All signal lines open.
5. $\overline{\text{PD}} = 0.0V$.
6. Guaranteed by design; not production tested.
7. R_1 through R_9 only.
8. R_1 through R_9 and $\overline{\text{PD}}$.
9. $V_{\text{SIGNAL}} = 0.2V$.

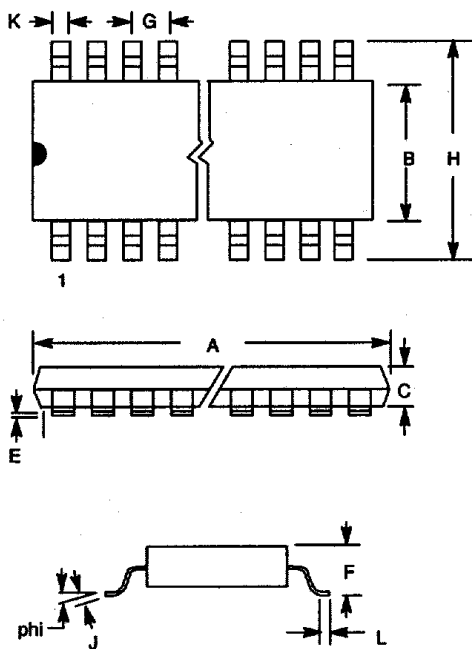
DS21T07S SCSI TERMINATOR 16-PIN SOIC (300-mil)

| PKG | 16-PIN | |
|-------|-----------|-----------|
| DIM | MIN | MAX |
| A IN. | 0.402 | 0.412 |
| MM | 10.21 | 10.46 |
| B IN. | 0.290 | 0.300 |
| MM | 7.37 | 7.65 |
| C IN. | 0.089 | 0.095 |
| MM | 2.26 | 2.41 |
| E IN. | 0.004 | 0.012 |
| MM | 0.102 | 0.30 |
| F IN. | 0.094 | 0.105 |
| MM | 2.38 | 2.68 |
| G IN. | 0.050 BSC | |
| MM | 1.27 BSC | |
| H IN. | 0.398 | 0.416 |
| MM | 10.11 | 10.57 |
| J IN. | 0.009 | 0.013 |
| MM | 0.229 | 0.33 |
| K IN. | 0.013 | 0.019 |
| MM | 0.33 | 0.48 |
| L IN. | 0.016 | 0.040 |
| MM | 0.40 | 1.02 |
| phi | 0° | 8° |

DS21T07E SCSI TERMINATOR 20-PIN TSSOP

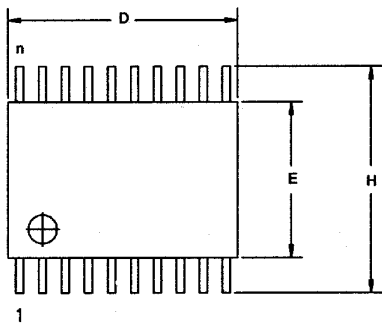

1

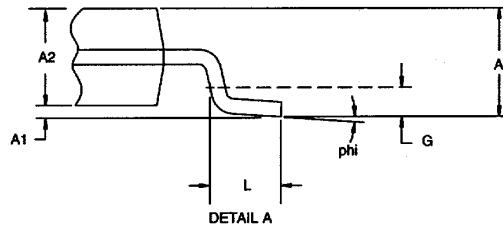
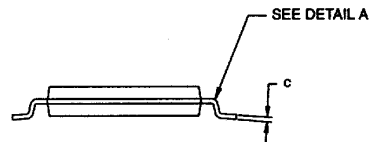
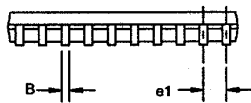

| DIM | MIN | MAX |
|-------|----------|------|
| A MM | - | 1.10 |
| A1 MM | 0.05 | - |
| A2 MM | 0.75 | 1.05 |
| C MM | 0.09 | 0.18 |
| L MM | 0.50 | 0.70 |
| e1 MM | 0.65 BSC | |
| B MM | 0.18 | 0.30 |
| D MM | 6.40 | 6.90 |
| E MM | 4.40 NOM | |
| G MM | 0.25 REF | |
| H MM | 6.25 | 6.55 |
| phi | 0° | 8° |