



Quartz Crystal Specification

IQD Part No. + Packaging: LFX TAL063075Reel

Würth Part No. 830063075



Description

- Industry standard SMD crystal
Resistance welded, hermetically sealed in an inert atmosphere, glass to metal seals on leads
Lead wires are mounted onto a plastic former to create a gull wing mount
- Model HC49/4HSMX
- Model Issue number 17

Frequency Parameters

- Frequency 17.20320MHz
- Frequency Tolerance ± 30.00 ppm
- Tolerance Condition @ 25°C $\pm 2^\circ\text{C}$
- Frequency Stability ± 50.00 ppm
- Operating Temperature Range -40.00 to 85.00°C
- Overtone Order Fundamental
- Ageing ± 5 ppm typ per year @ 25°C

Electrical Parameters

- Load Capacitance (CL) 22.00pF
- Shunt Capacitance (C0) 7pF max
- Drive Level 500 μ W max
- ESR 40.00 Ω max

Environmental Parameters

- Shock: 981m/s², 6ms, 3 times in each of 3 mutually perpendicular planes
- Vibration: 10Hz-60Hz, 0.75mm amplitude, 60Hz-500Hz, 98.1m/s², 30mins in 3 mutually perpendicular planes
- Storage Temperature Range: -55 to 125°C

Manufacturing Details

- RoHS Terminations SnAgCu or Sn
- RoHS Reflow Temp 260degC 10s

Compliance

- RoHS Status (2011/65/EU) Compliant
- REACH Status Compliant
- MSL Rating (JDEC-STD-033): Not Applicable

Packaging Details

- Pack Style: Reel Tape & reel in accordance with EIA-481-D
Pack Size: 1,000
- Alternative packing option available

USEFUL LINKS

Toolbox:

www.we-online.com/toolbox

Product Catalog:

www.we-online.com/products



Outline (mm)

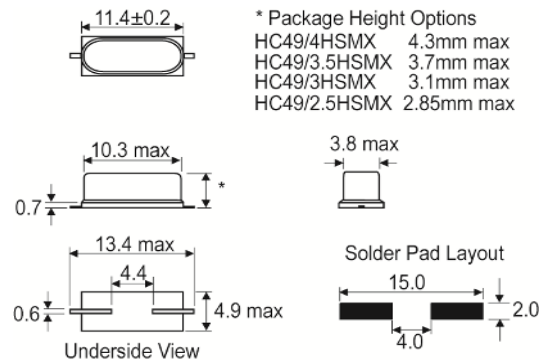

Typical Frequency vs Temperature Curves



CONTACT INFORMATION:

Würth Elektronik eiSos GmbH & Co. KG
 Max-Eyth-Str. 1, 74638 Waldenburg, Germany
 Tel: +49(0) 7942 945-0

Email: eiSos@we-online.de
 Web: www.we-online.com