



PART NAME

PTH MOUNTING PLATE (PLASTIC)

PART No.

PTX-22510-P

REVISION DATE

10-20-17

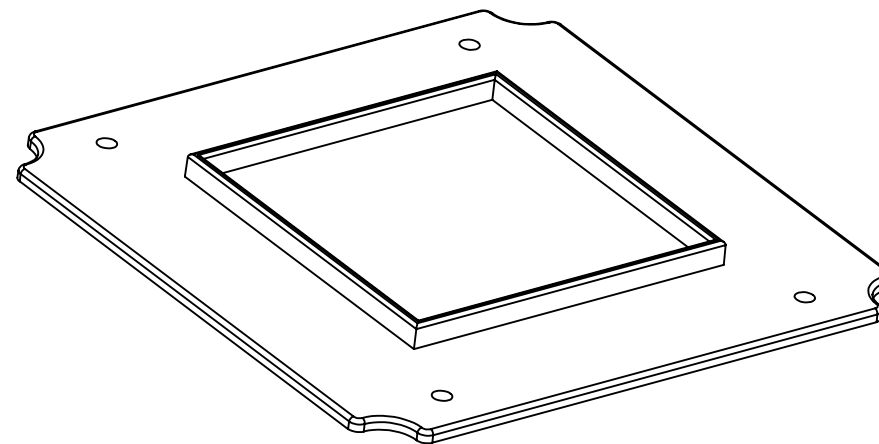
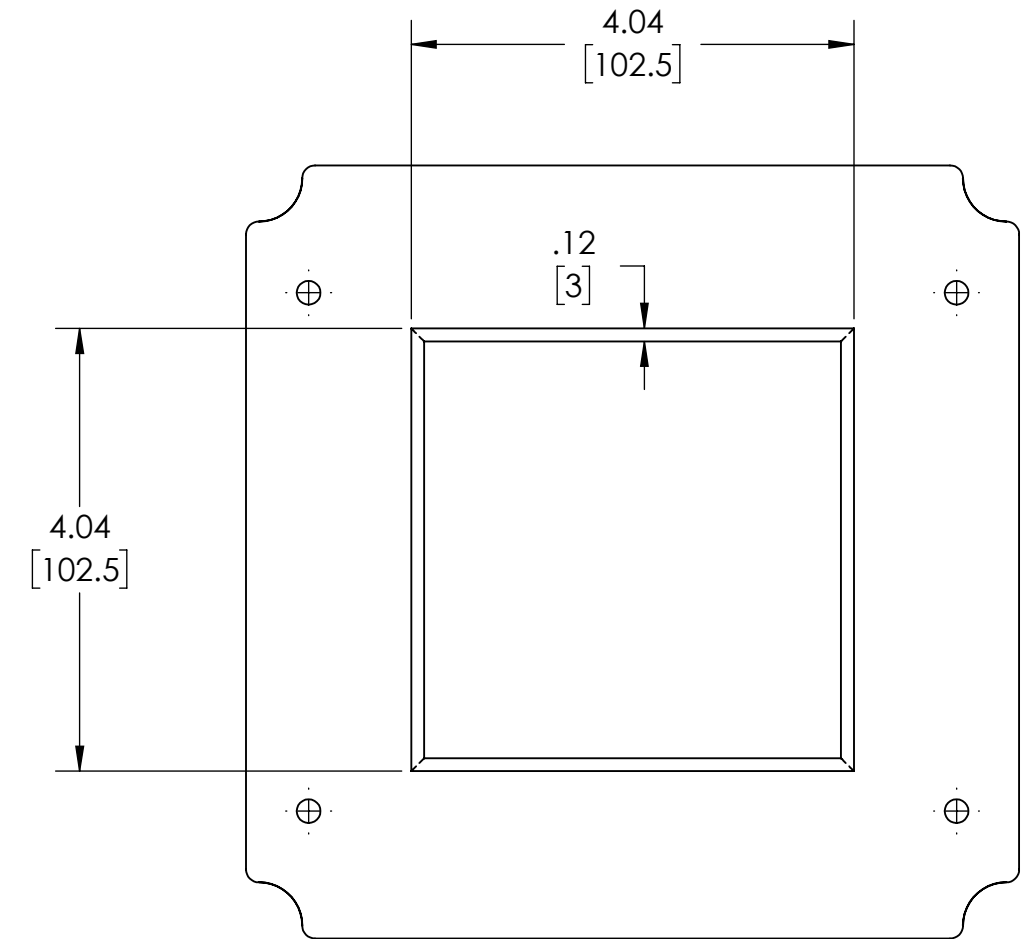
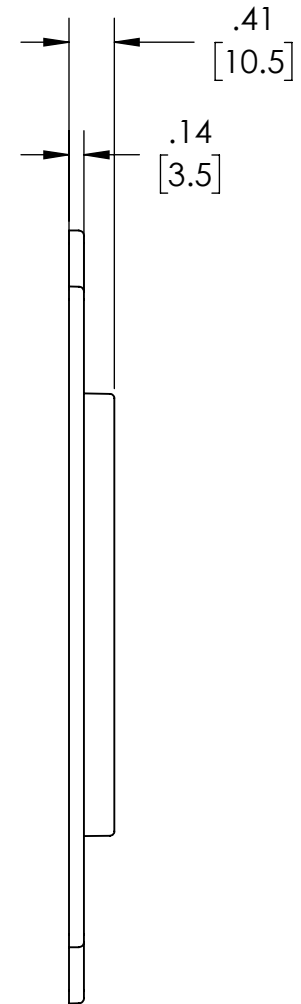
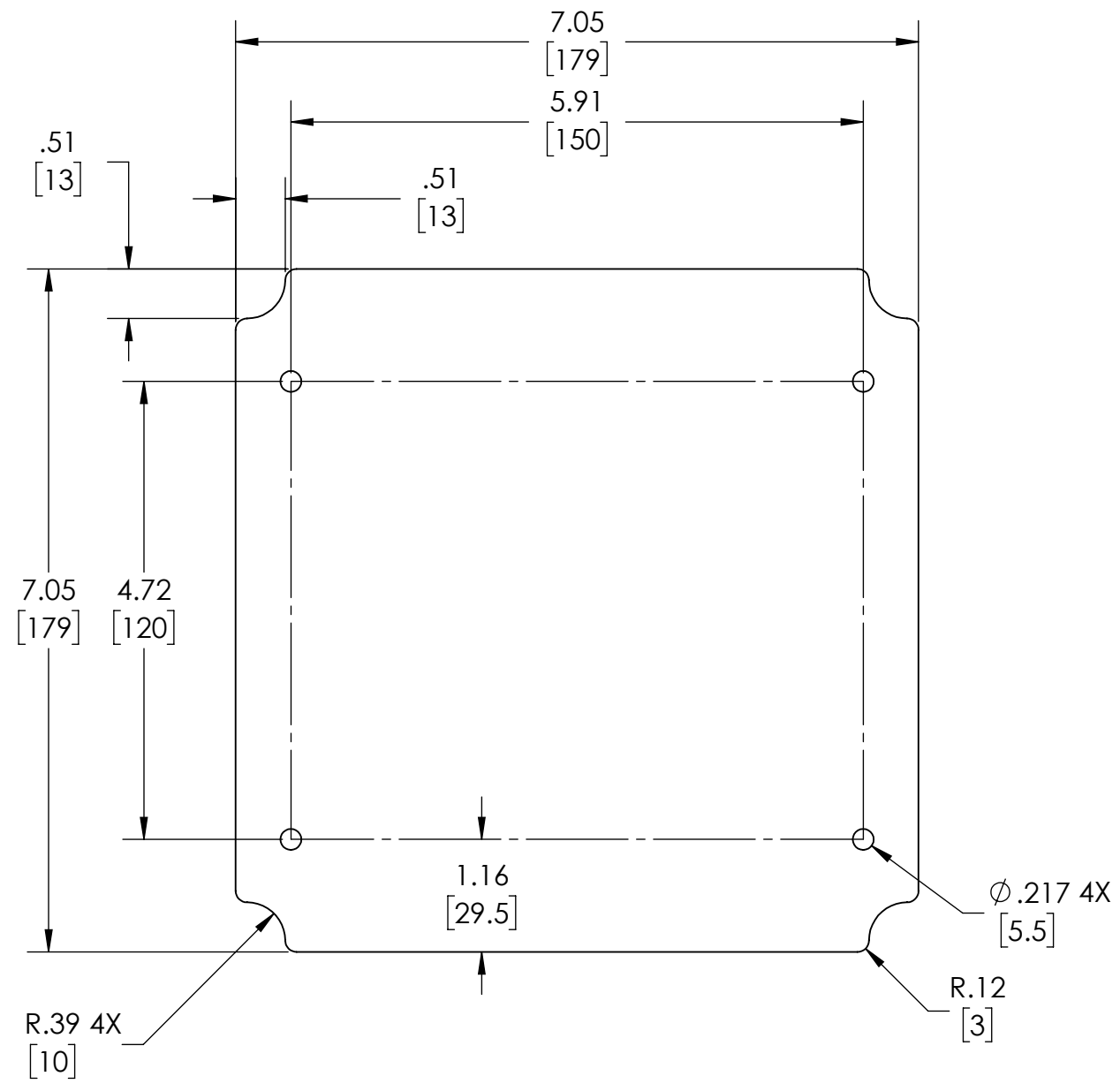

DRAWING FOR REFERENCE
 WE RESERVE THE RIGHT TO MAKE CHANGES TO OUR
 STANDARD PRODUCTS. PLEASE CONSULT WITH BUD INDUSTRIES
 PRIOR TO USING THIS DRAWING FOR DESIGN PURPOSE.

MATERIAL - ABS PLASTIC

FINISH - LIGHT GRAY

DIMENSIONS IN INCH[MM]

PANEL FITS THE FOLLOWING ENCLOSURES:
PTH-22510 & PTH-22510-C