

42437-5 ✓ ACTIVE

FASTON | FASTON 250

TE Internal #: 42437-5

Quick Disconnects, Receptacle, 14 – 10 AWG Wire Size, 2.08 – 5.26 mm² Wire Size, Mating Tab Width 6.35 mm [.25 in], Straight, FASTON 250

[View on TE.com >](#)



Terminals & Splices > Quick Disconnects

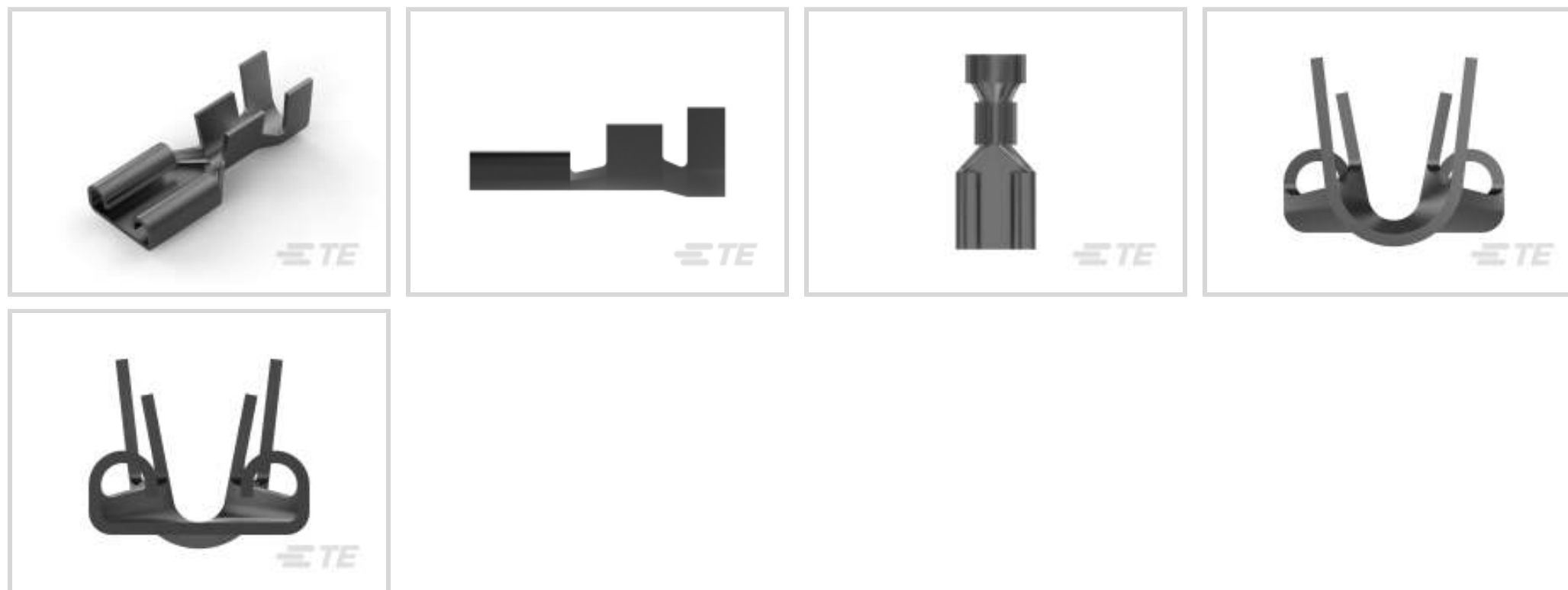

Quick Disconnect Terminal Type: **Receptacle**

Wire Size: **2.08 – 5.26 mm²**

Mating Tab Width: **6.35 mm [.25 in]**

Mating Tab Thickness: **.81 mm [.032 in]**

Features

Product Type Features

Insertion Force	Low
-----------------	-----

Configuration Features

Connection Capacity	Single
---------------------	--------

Compatible With Wire & Cable Type	Discrete Wire
-----------------------------------	---------------

Contact Features

Quick Disconnect Terminal Type	Receptacle
--------------------------------	------------

Mating Tab Width	6.35 mm [.25 in]
------------------	------------------

Mating Tab Thickness	.81 mm [.032 in]
----------------------	------------------

Terminal Orientation	Straight
----------------------	----------

Contact Base Material	Phosphor Bronze
-----------------------	-----------------

Terminal Plating Material	Tin
---------------------------	-----

Crimp Type	F-Crimp
------------	---------

Barrel Type	Open
-------------	------

Termination Features



Product Terminates To	Wire & Cable
-----------------------	--------------

Mechanical Attachment

Wire Insulation Support	With
-------------------------	------

Mating Retention Type	Dimple
-----------------------	--------

Dimensions

Terminal Material Thickness	.46 mm[.018 in]
-----------------------------	-----------------

Product Length	19.56 mm[.77 in]
----------------	------------------

Compatible Insulation Diameter Range	3.81 – 5.08 mm[.15 – .2 in]
--------------------------------------	-----------------------------

Wire Size	2.08 – 5.26 mm ²
-----------	-----------------------------

Usage Conditions

Insulation Option	Uninsulated
-------------------	-------------

Operating Temperature Range	-40 – 110 °C[-40 – 230 °F]
-----------------------------	----------------------------

Industry Standards

Agency/Standard	CSA, UL
-----------------	---------

Packaging Features

Packaging Quantity	8000
--------------------	------

Packaging Method	Strip/Reel
------------------	------------

Other

Line	Premier
------	---------

Product Compliance

[For compliance documentation, visit the product page on TE.com>](#)

EU RoHS Directive 2011/65/EU	Compliant
------------------------------	-----------

EU ELV Directive 2000/53/EC	Compliant
-----------------------------	-----------

China RoHS 2 Directive MIIT Order No 32, 2016	No Restricted Materials Above Threshold
---	---

EU REACH Regulation (EC) No. 1907/2006	Current ECHA Candidate List: JUNE 2023 (235) Candidate List Declared Against: JAN 2023 (233) Does not contain REACH SVHC
--	--

Halogen Content	Low Halogen - Br, Cl, F, I < 900 ppm per homogenous material. Also BFR/CFR/PVC Free
-----------------	---

Solder Process Capability	Not applicable for solder process capability
---------------------------	--

Product Compliance Disclaimer

This information is provided based on reasonable inquiry of our suppliers and represents our current actual knowledge based on the information they provided. This information is subject to change. The part numbers that TE has identified as EU RoHS compliant have a maximum concentration of 0.1% by weight in homogenous materials for lead, hexavalent chromium, mercury, PBB, PBDE, DBP, BBP, DEHP, DIBP, and 0.01% for cadmium, or qualify for an exemption to these limits as defined in the Annexes of Directive 2011/65/EU (RoHS2). Finished electrical and electronic equipment products will be CE marked as required by Directive 2011/65/EU. Components may not be CE marked. Additionally, the part numbers that TE has identified as EU ELV compliant have a maximum concentration of 0.1% by weight in homogenous materials for lead, hexavalent chromium, and mercury, and 0.01% for cadmium, or qualify for an exemption to these limits as defined in the Annexes of Directive 2000/53/EC (ELV). Regarding the REACH Regulation, the information TE provides on SVHC in articles for this part number is based on the latest European Chemicals Agency (ECHA) 'Guidance on requirements for substances in articles' posted at this URL: <https://echa.europa.eu/guidance-documents/guidance-on-reach>

Compatible Parts

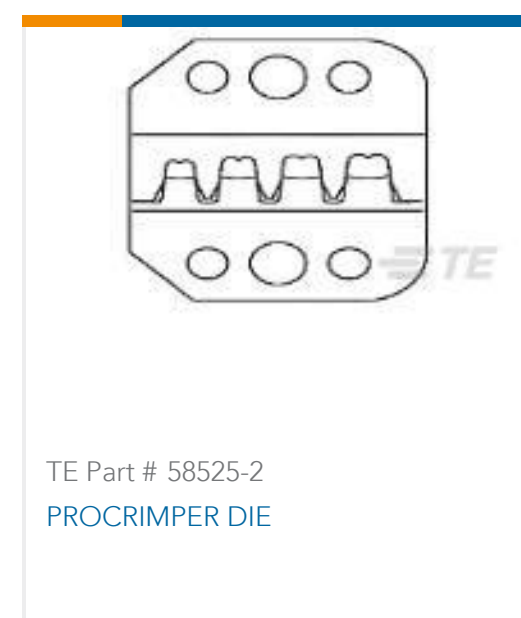

Also in the Series | **FASTON 250**



Compression Connectors(4)

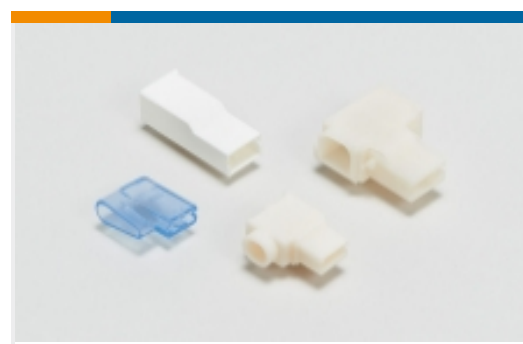

Crimp Terminal Housings(142)



Insertion & Extraction Tools(6)



Magnet Wire Terminals(1)



PCB Terminals(135)

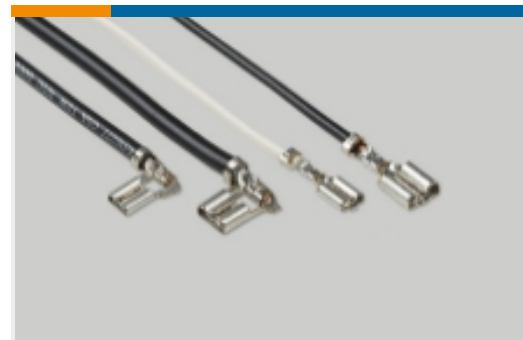

Quick Disconnects(445)



Splices(4)

Customers Also Bought

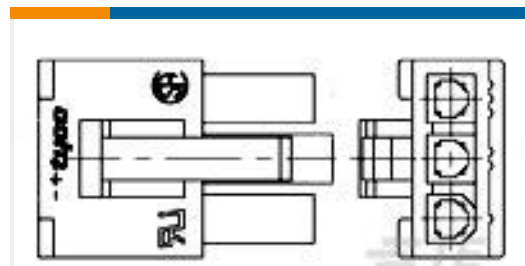

TE Part #2029112-3
3P RCPT SR VAL-U-LOK GW



TE Part #41800
250 FASTON FLAG REC 18-12 AWG TPBZ

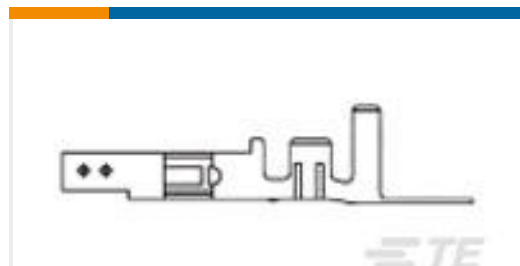

TE Part #794958-3
VAL-U-LOK SKT PHBZ SN 22-26AWG



TE Part #35111
TERMINAL,PIDG R 12-10 5/16

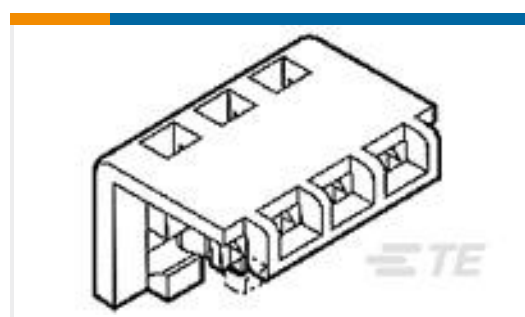

TE Part #1-643067-0
10P MTA156 MOLDED COVER



TE Part #60294-1
FF 250 TAB 22-18AWG BR

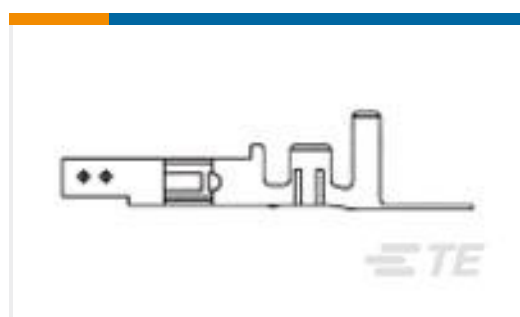

TE Part #2238017-1
VAL-U-LOK SKT BR SN 18-22AWG



TE Part #1586055-3
VAL-U-LOK SKT PHBZ SN 16AWG

Documents

Product Drawings

[250 FASTON REC 14-10 AWG TPBZ](#)

English

CAD Files

[3D PDF](#)

[3D](#)

[Customer View Model](#)

[ENG_CVM_CVM_42437-5_AU.2d_dxf.zip](#)



English

Customer View Model

[ENG_CVM_CVM_42437-5_AU.3d_igs.zip](#)

English

Customer View Model

[ENG_CVM_CVM_42437-5_AU.3d_stp.zip](#)

English

By downloading the CAD file I accept and agree to the [Terms and Conditions](#) of use.

Datasheets & Catalog Pages

[82004 FASTON Terminals \(Insulated and Uninsulated\) Catalog - FASTON Receptacles Section](#)

English

Product Specifications

[Application Specification](#)

English

[Application Specification](#)

English

[Wire Preparation And Crimp Inspection Guide](#)

English

Product Environmental Compliance

[MD_42437-5_042020172329_dmtec](#)

English

[MD_42437-5_042020172329_dmtec](#)

English