

926476-4 ✓ ACTIVE

AMPMODU | AMPMODU IV/V

TE Internal #: 926476-4

Housing, Receptacle, Wire-to-Board, 8 Position, .1 in [2.54 mm]

Centerline, Crimp, 2 Row, Black, Wire & Cable, Signal, AMPMODU IV/V

[View on TE.com >](#)



Connectors > PCB Connectors > Wire-to-Board Connectors > Wire-to-Board Connector Assemblies & Housings

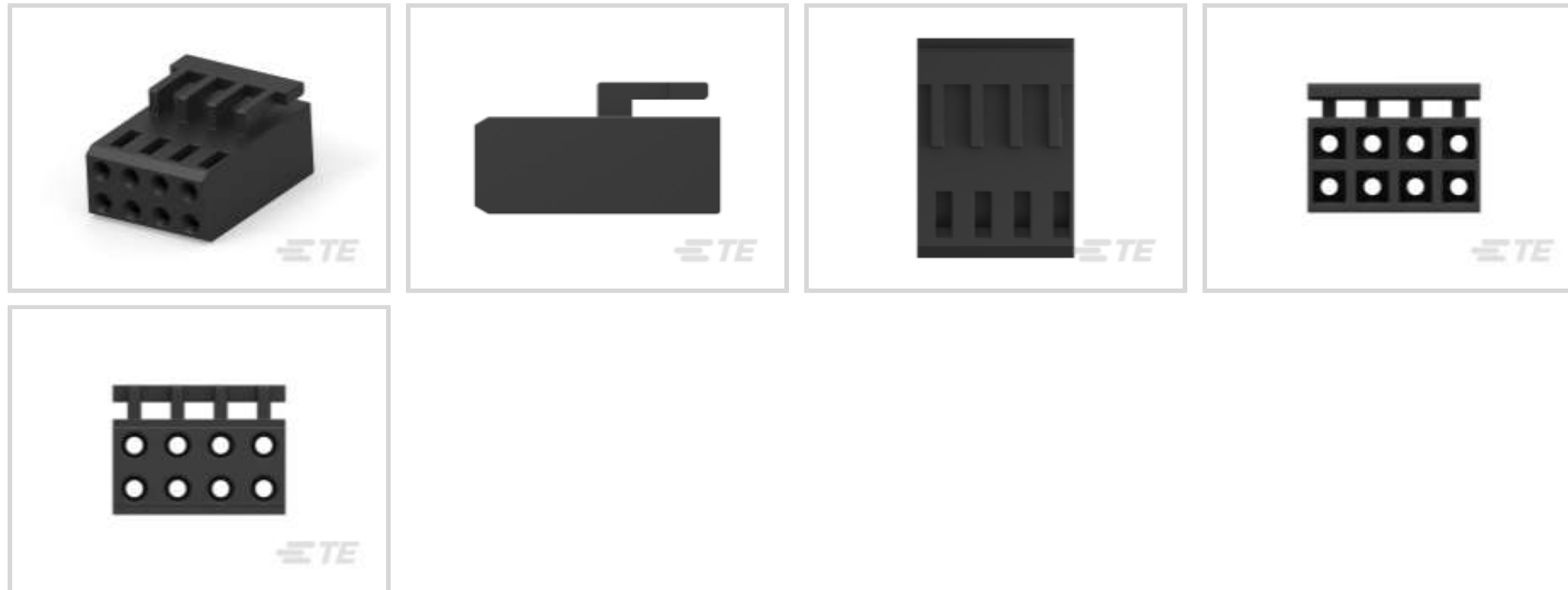

Connector Product Type: **Housing**

Connector & Housing Type: **Receptacle**

Connector System: **Wire-to-Board**

Number of Positions: **8**

Centerline (Pitch): **2.54 mm [.1 in]**

## Features

### Product Type Features

Connector Product Type	Housing
Connector & Housing Type	Receptacle
Connector System	Wire-to-Board
Connector & Contact Terminates To	Wire & Cable

### Configuration Features

Number of Positions	8
Number of Rows	2

### Electrical Characteristics

Operating Voltage	250 VAC
-------------------	---------

### Body Features

Primary Product Color	Black
-----------------------	-------

### Contact Features

Contact Type	Socket
--------------	--------



Contact Current Rating (Max)	3 A
------------------------------	-----

### Termination Features

Termination Method to Wire & Cable	Crimp
------------------------------------	-------

### Mechanical Attachment

Strain Relief	Without
---------------	---------

PCB Mount Retention	With
---------------------	------

Mating Retention	Without
------------------	---------

Connector Mounting Type	Cable Mount (Free-Hanging)
-------------------------	----------------------------

### Housing Features

Housing Entry Configuration	Both Ends Closed
-----------------------------	------------------

Housing Material	Crastin SK642FR
------------------	-----------------

Centerline (Pitch)	2.54 mm[.1 in]
--------------------	----------------

### Dimensions

Connector Length	10.16 mm[.39 in]
------------------	------------------

Row-to-Row Spacing	2.54 mm[.1 in]
--------------------	----------------

### Usage Conditions

Operating Temperature Range	-65 – 105 °C[-85 – 221 °F]
-----------------------------	----------------------------

### Operation/Application

Circuit Application	Signal
---------------------	--------

### Industry Standards

UL Flammability Rating	UL 94V-0
------------------------	----------

### Packaging Features

Packaging Quantity	1000
--------------------	------

Packaging Method	Bag
------------------	-----

### Product Compliance

[For compliance documentation, visit the product page on TE.com>](#)

EU RoHS Directive 2011/65/EU	Compliant
------------------------------	-----------

EU ELV Directive 2000/53/EC	Compliant
-----------------------------	-----------

China RoHS 2 Directive MIIT Order No 32, 2016	No Restricted Materials Above Threshold
---	---

EU REACH Regulation (EC) No. 1907/2006	Current ECHA Candidate List: JUNE 2023 (235)
--	--











Candidate List Declared Against: JUNE 2023 (235)  
Does not contain REACH SVHC

Halogen Content	Not Low Halogen - contains Br or Cl > 900 ppm.
Solder Process Capability	Not applicable for solder process capability

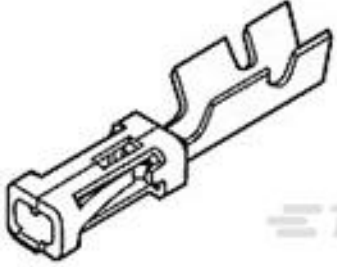
Product Compliance Disclaimer

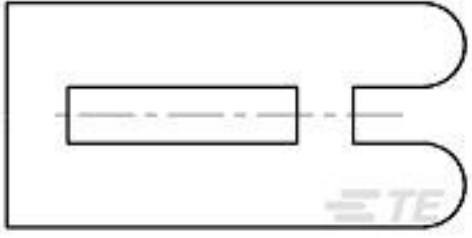
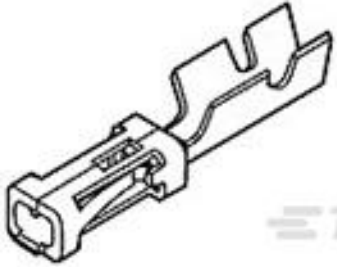
This information is provided based on reasonable inquiry of our suppliers and represents our current actual knowledge based on the information they provided. This information is subject to change. The part numbers that TE has identified as EU RoHS compliant have a maximum concentration of 0.1% by weight in homogenous materials for lead, hexavalent chromium, mercury, PBB, PBDE, DBP, BBP, DEHP, DIBP, and 0.01% for cadmium, or qualify for an exemption to these limits as defined in the Annexes of Directive 2011/65/EU (RoHS2). Finished electrical and electronic equipment products will be CE marked as required by Directive 2011/65/EU. Components may not be CE marked. Additionally, the part numbers that TE has identified as EU ELV compliant have a maximum concentration of 0.1% by weight in homogenous materials for lead, hexavalent chromium, and mercury, and 0.01% for cadmium, or qualify for an exemption to these limits as defined in the Annexes of Directive 2000/53/EC (ELV). Regarding the REACH Regulation, the information TE provides on SVHC in articles for this part number is based on the latest European Chemicals Agency (ECHA) 'Guidance on requirements for substances in articles' posted at this URL: <https://echa.europa.eu/guidance-documents/guidance-on-reach>

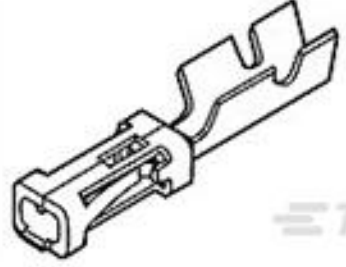
### Compatible Parts

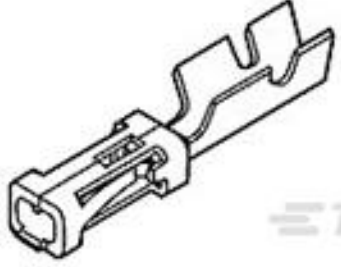
 <p>TE Part # 826469-4 2X4P MOD II SHROUDED HEADER, ST</p>	 <p>TE Part # 826470-4 2X4P MOD II SHROUDED HEADER, RT ANG.</p>	 <p>TE Part # 1-141708-1 MOD IV RECEPTACLE, CRIMP SNAP IN, LP</p>	 <p>TE Part # 141708-1 MOD-4 REC.CONT.SCP.</p>
 <p>TE Part # 926477-1 RETENTION FORK</p>	 <p>TE Part # 926498-3 MOD2 KODIERSTUECK</p>	 <p>TE Part # 167021-2 MOD-4 REC.CONT.SCP.</p>	 <p>TE Part # 167301-4 MOD-4 REC.CONT.SCP</p>
 <p>TE Part # 2-167301-4 MOD-4 REC.CONT.SCP</p>	 <p>TE Part # 2-167301-2 MOD-4 REC.CONT.SCP</p>	 <p>TE Part # 166309-2 MOD-5 REC.CONTACT</p>	 <p>TE Part # 167024-1 MOD-4 REC.CONT.SCP.</p>

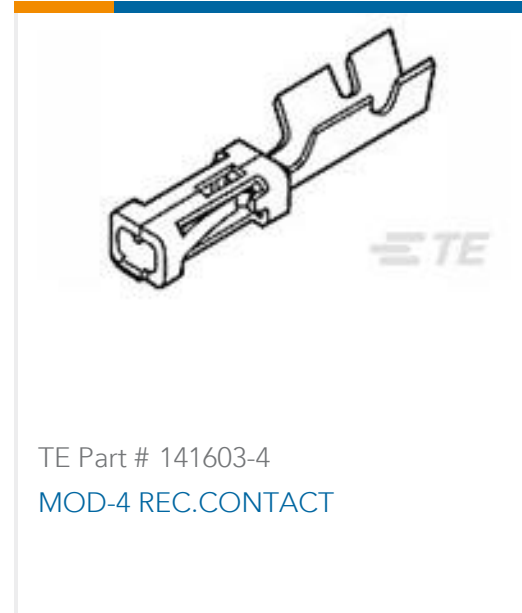
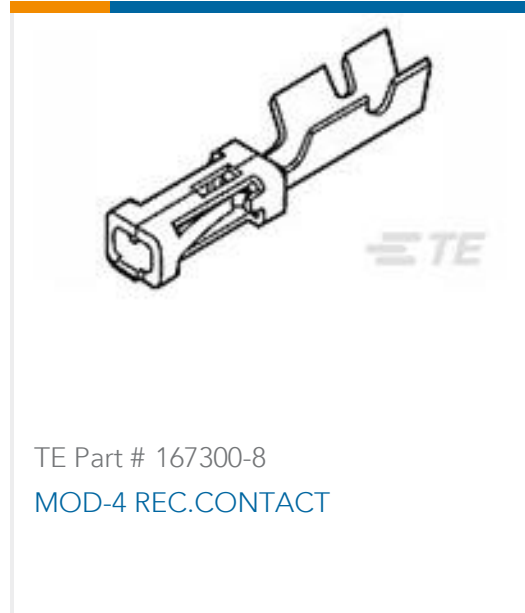
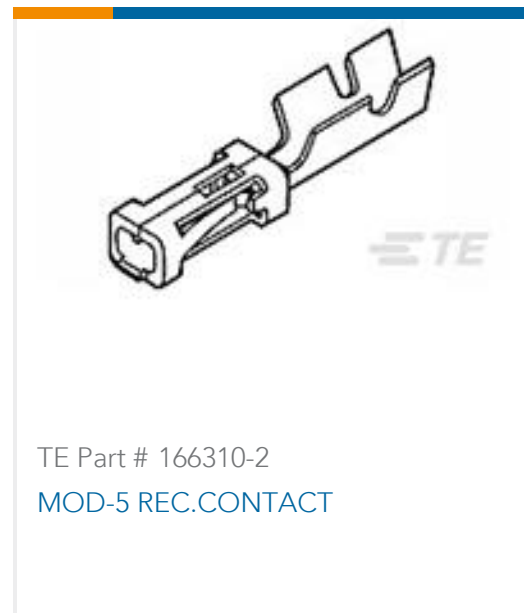
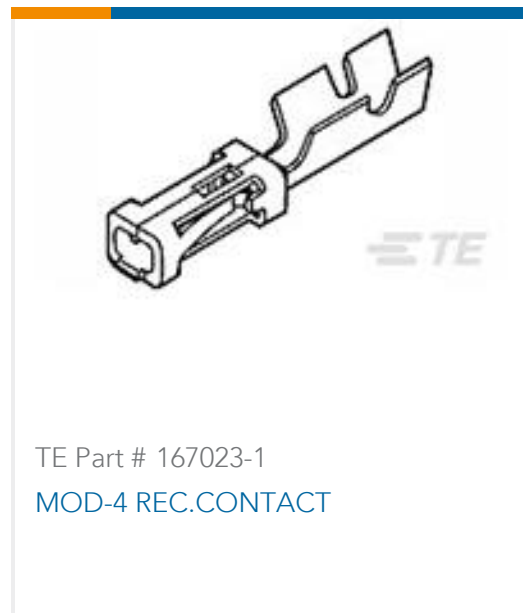
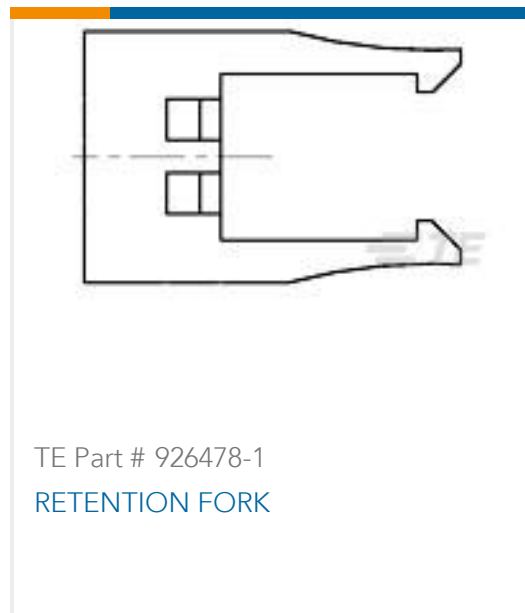

Also in the Series | AMPMODU IV/V

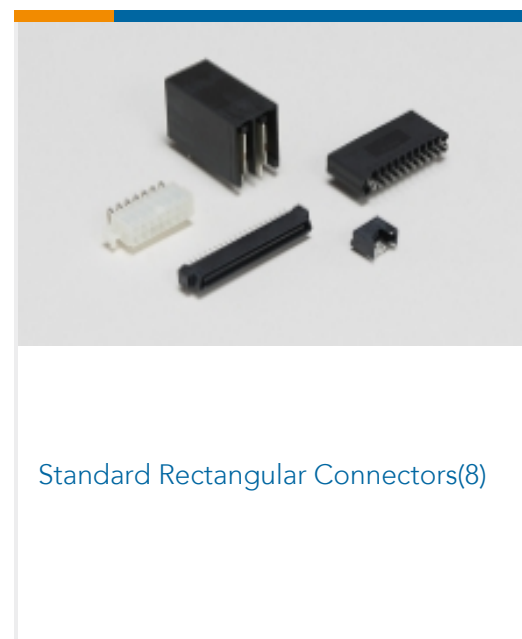
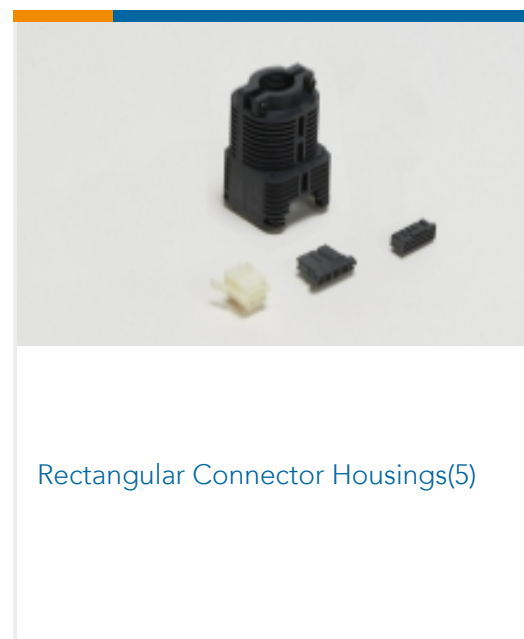
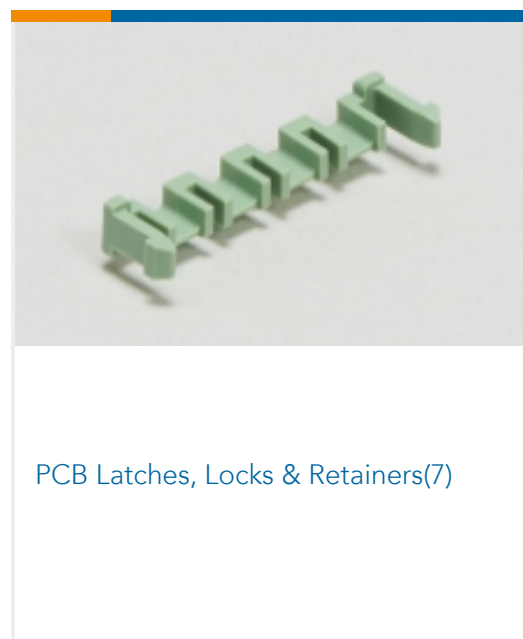
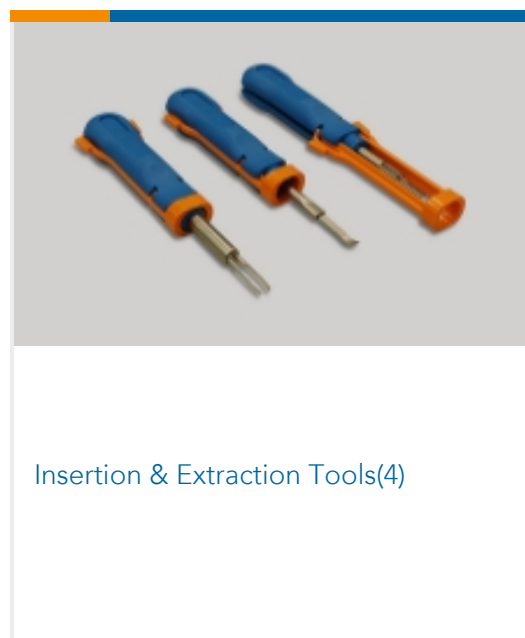
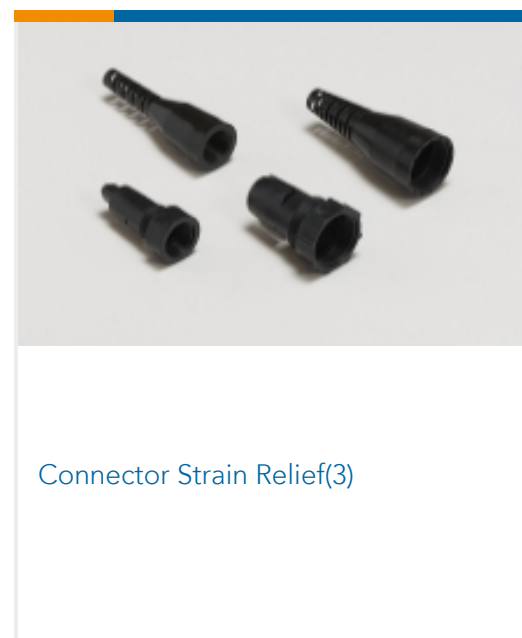
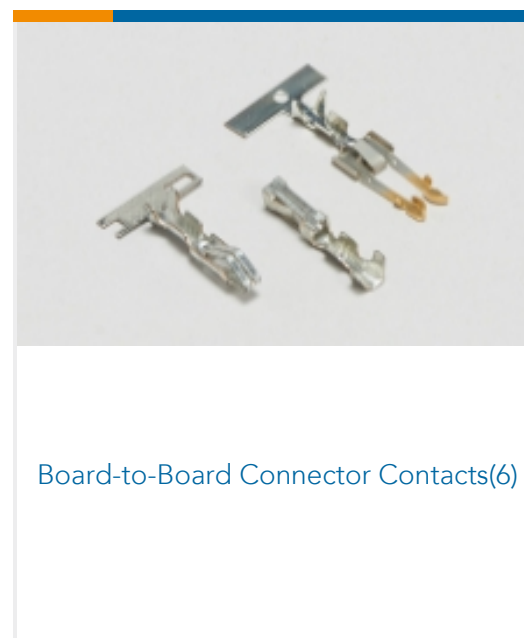
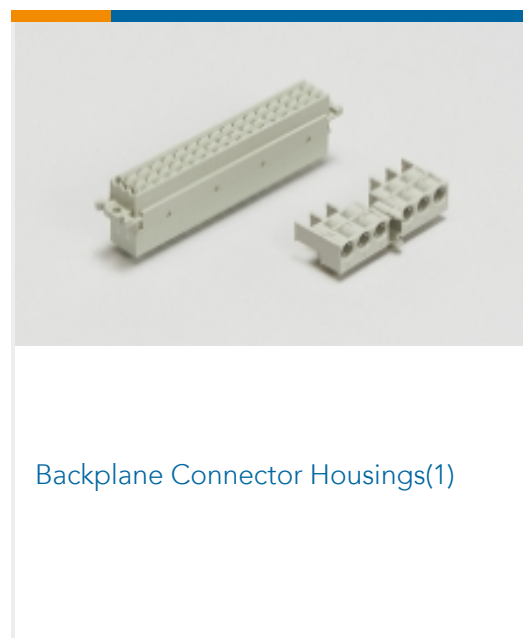
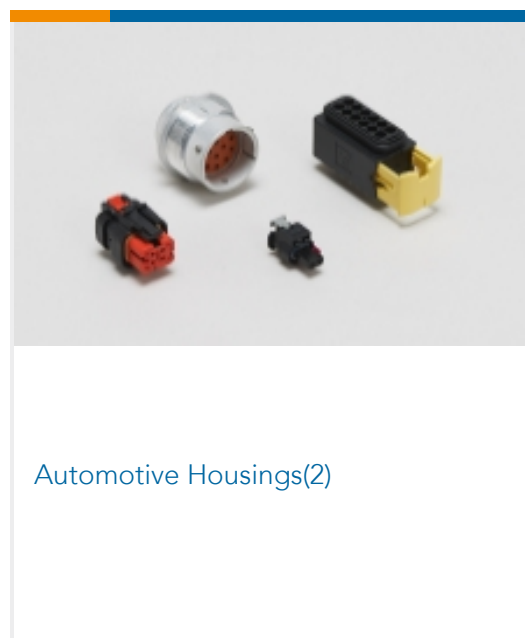



Wire-to-Board Connector Assemblies & Housings(447)



Wire-to-Board Connector Contacts (322)

## Customers Also Bought



TE Part #926475-4  
MOD 4 HSG



TE Part #926885-3  
UNIV.M-N-L.PIN



TE Part #926476-6  
MOD 4 HSG



TE Part #1393236-7  
V23092-A1012-A301

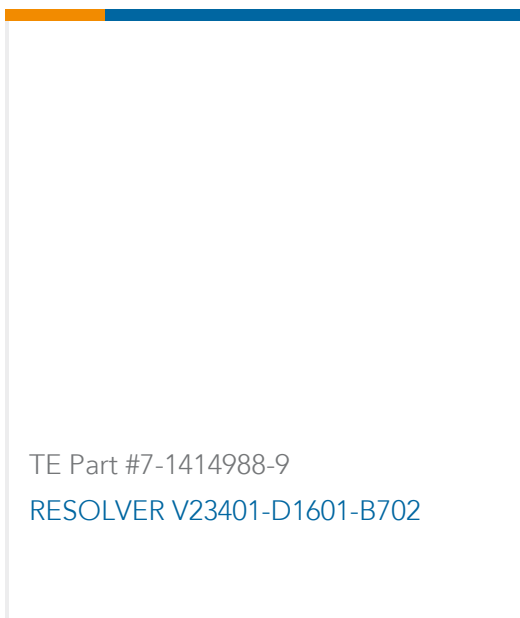

TE Part #7-1414988-9  
RESOLVER V23401-D1601-B702

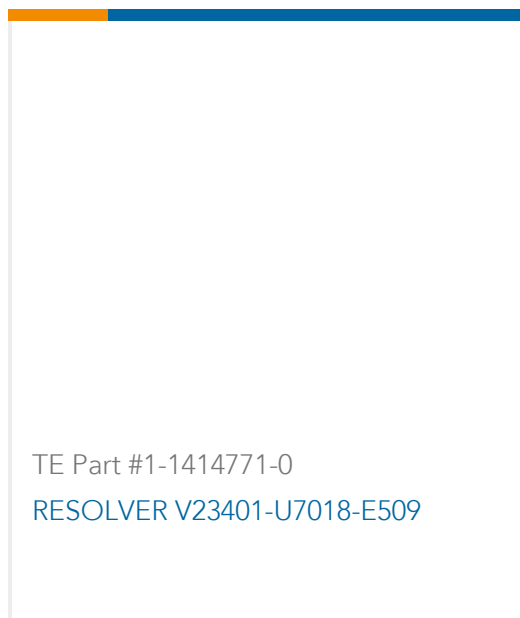

TE Part #1-1414771-0  
RESOLVER V23401-U7018-E509

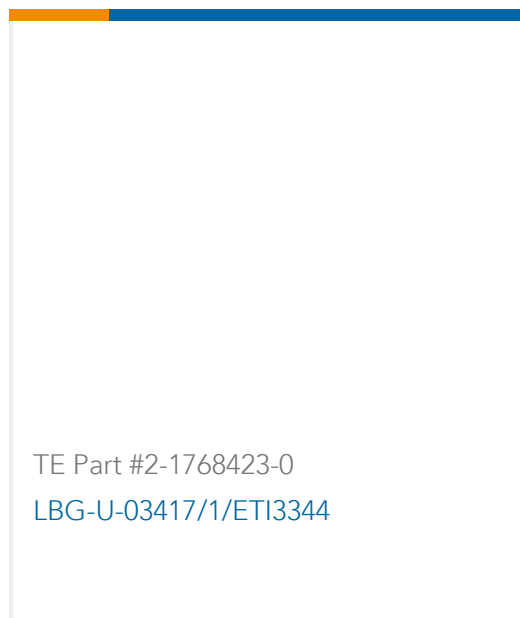

TE Part #2-1768423-0  
LBG-U-03417/1/ETI3344

## Documents

### Product Drawings

[2X4P MODU 4 HSG.](#)

English

### CAD Files

[3D PDF](#)

English

Customer View Model

[ENG\\_CVM\\_926476-4\\_O.3d\\_igs.zip](#)

English

Customer View Model

[ENG\\_CVM\\_926476-4\\_O.3d\\_stp.zip](#)

English

Customer View Model

[ENG\\_CVM\\_926476-4\\_O.2d\\_dxf.zip](#)

English

By downloading the CAD file I accept and agree to the [Terms and Conditions](#) of use.



---

## Product Specifications

### Product Specification

English

---

## Agency Approvals

### UL Report

English