

LM4982 Boomer™ Audio Power Amplifier Series Ground-Referenced, Ultra Low Noise, 80mW Stereo Headphone Amplifier with IntelliSense and I2C Volume Control

Check for Samples: [LM4982](#)

FEATURES

- Ground Referenced Outputs
- I²C Volume and Mode Controls
- Available in Space-Saving DSBGA Package
- Ultra Low Current Shutdown Mode
- Advanced Pop & Click Circuitry Eliminates Noises During Turn-On and Turn-Off Transitions
- 1.6 – 4.0V Operation
- No Output Coupling Capacitors, Snubber Networks, Bootstrap Capacitors or Gain-Setting Resistors Required
- Mono/Stereo Headphone Detect

APPLICATIONS

- Notebook PCs
- Desktop PCs
- Mobile Phones
- PDAs
- Portable Electronic Devices
- MP3 Players

KEY SPECIFICATIONS

- Improved PSRR at 217Hz, 66dB
- Stereo Output Power at $V_{DD} = 3V$, $R_L = 32\Omega$, THD+N = 1%, 51mW (Typ)
- Shutdown Current, 0.1 μ A (Typ)

DESCRIPTION

The LM4982 is a ground referenced, variable gain audio power amplifier capable of delivering 80mW of continuous average power into a 16 Ω single-ended load with less than 1% THD+N from a 3V power supply. The I²C volume control allows +18 to -76 dB gain settings.

The LM4982 utilizes advanced charge pump technology to generate the LM4982's negative supply voltage. This eliminates the need for output-coupling capacitors typically used with single-ended loads.

IntelliSense is a new circuit technology that allows the LM4982 to detect whether a mono or stereo headphone plug has been inserted into the output jack.

Boomer audio power amplifiers were designed specifically to provide high quality output power with a minimal amount of external components. The LM4982 does not require output coupling capacitors or bootstrap capacitors, and therefore is ideally suited for mobile phone and other low voltage applications where minimal power consumption is a primary requirement.

The LM4982 incorporates selectable low-power consumption shutdown and channel select modes.

The LM4982 contains advanced pop & click circuitry that eliminates noises which would otherwise occur during turn-on and turn-off transitions.



Please be aware that an important notice concerning availability, standard warranty, and use in critical applications of Texas Instruments semiconductor products and disclaimers thereto appears at the end of this data sheet.

Boomer is a trademark of Texas Instruments.

All other trademarks are the property of their respective owners.

Typical Application

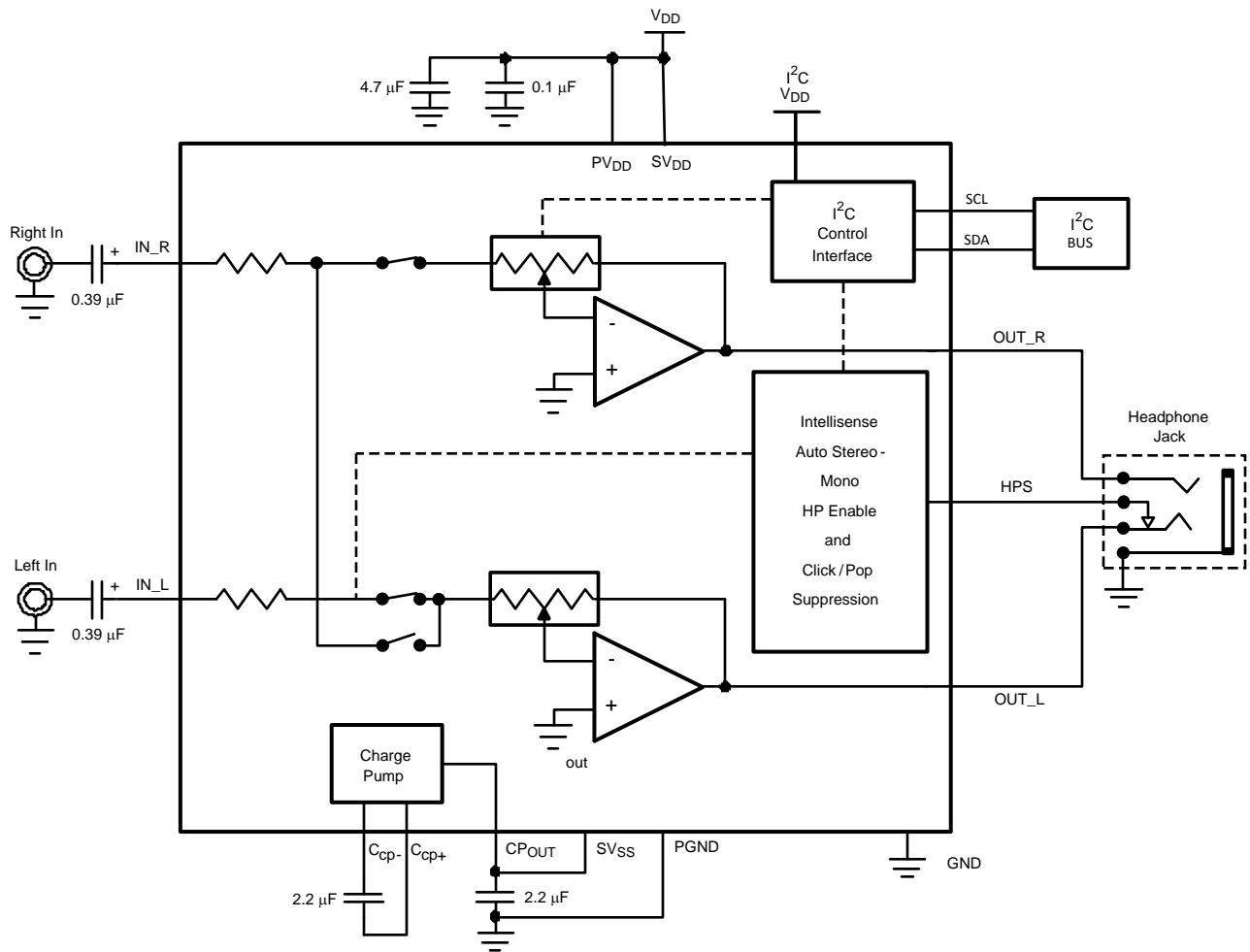
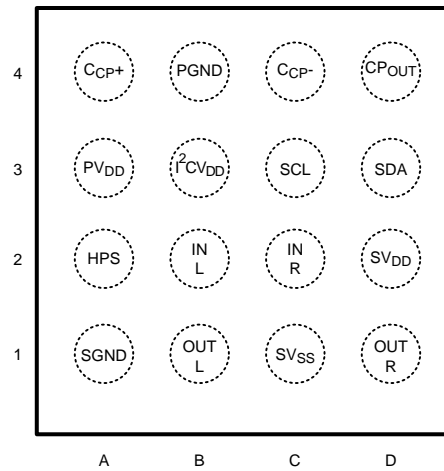

Figure 1. Typical Audio Amplifier Application Circuit

Connection Diagram



**Figure 2. DSBGA Package
Top View**

PIN DESCRIPTIONS

Pin Designator	Pin Name	Pin Function
A1	SGND	Amplifier ground
A2	HPE	Headphone sende input
A3	PV _{DD}	Charge pump / digital power supply
A4	C _{CP+}	Charge pump fly capacitor positive side
B1	OUT_L	Left channel output
B2	IN_L	Left channel input
B3	I ² C_V _{DD}	I ² C power supply
B4	PGND	Charge pump / digital ground
C1	SV _{SS}	Amplifier negative supply
C2	IN_R	Right channel input
C3	SCL	I ² C SCL line
C4	C _{CP-}	Charge pump fly capacitor negative side
D1	OUT_R	Right channel output
D2	SV _{DD}	Amplifier positive supply
D3	SDA	I ² C SDA line
D4	CP _{OUT}	Charge pump power output



These devices have limited built-in ESD protection. The leads should be shorted together or the device placed in conductive foam during storage or handling to prevent electrostatic damage to the MOS gates.

Absolute Maximum Ratings⁽¹⁾

Supply Voltage	4.5V
Storage Temperature	-65°C to +150°C
Input Voltage	-0.3V to V _{DD} + 0.3V
Power Dissipation ⁽²⁾	Internally Limited
ESD Susceptibility ⁽³⁾	2000V
ESD Susceptibility ⁽⁴⁾	200V
Junction Temperature	150°C
Thermal Resistance	θ_{JA} (typ) - (YZR0016)
	105°C/W (note X)

- (1) Absolute Maximum Ratings indicate limits beyond which damage to the device may occur. Operating Ratings indicate conditions for which the device is functional but do not ensure specific performance limits. Electrical Characteristics state DC and AC electrical specifications under particular test conditions which ensure specific performance limits. This assumes that the device is within the Operating Ratings. Specifications are not ensured for parameters where no limit is given, however, the typical value is a good indication of device performance.
- (2) The maximum power dissipation must be derated at elevated temperatures and is dictated by T_{JMAX}, θ_{JA} , and the ambient temperature, T_A. The maximum allowable power dissipation is P_{DMAX} = (T_{JMAX} - T_A) / θ_{JA} or the number given in Absolute Maximum Ratings, whichever is lower. For the LM4982, see power derating currents for more information.
- (3) Human body model, 100pF discharged through a 1.5k Ω resistor.
- (4) Machine Model, 220pF - 240pF discharged through all pins.

Operating Ratings

Temperature Range	T _{MIN} ≤ T _A ≤ T _{MAX}	-40°C ≤ T _A ≤ +85°C
Supply Voltage		1.6V ≤ V _{DD} ≤ 4.0V

Audio Amplifier Electrical Characteristics V_{DD} = 3V⁽¹⁾⁽²⁾

The following specifications apply for V_{DD} = 3V, R_L = 16 Ω , A_v = 0dB, unless otherwise specified. Limits apply for T_A = 25°C.

Symbol	Parameter	Conditions	LM4982		Units (Limits)
			Typical ⁽³⁾	Limits ⁽⁴⁾⁽⁵⁾	
I _{DD}	Quiescent Power Supply Current Full Power Mode	V _{IN} = 0V, inputs terminated, both channels enabled	8.1	11.5	mA (max)
		V _{IN} = 0V, inputs terminated, one channel enabled	5.1	7.3	mA
		V _{IN} = 0V, inputs terminated, No headphone inserted	2.15		mA
I _{SD}	Shutdown Current	With SD enabled	0.1	1.5	μ A (max)
V _{OS}	Output Offset Voltage	R _L = 32 Ω	0.7	4.5	mV (max)
A _v	Gain Max and Min settings	[B0:B4] = 00000	-70		dB
		[B0:B4] = 11111	+18		dB
R _{IN}	Input Resistance	gain setting 18dB	22	15 29	k Ω (min) k Ω (max)
		gain setting -76dB	200		k Ω
P _{OUT}	Stereo Output Power	THD+N = 1% (max); f = 1kHz, R _L = 16 Ω , per channel	47	40	mW (min)
		THD+N = 1% (max); f = 1kHz, R _L = 32 Ω , per channel	51		mW

- (1) All voltages are measured with respect to the GND pin unless otherwise specified.
- (2) Absolute Maximum Ratings indicate limits beyond which damage to the device may occur. Operating Ratings indicate conditions for which the device is functional but do not ensure specific performance limits. Electrical Characteristics state DC and AC electrical specifications under particular test conditions which ensure specific performance limits. This assumes that the device is within the Operating Ratings. Specifications are not ensured for parameters where no limit is given, however, the typical value is a good indication of device performance.
- (3) Typicals are measured at +25°C and represent the parametric norm.
- (4) Limits are specified to Texas Instruments' AOQL (Average Outgoing Quality Level).
- (5) Datasheet min/max specification limits are specified by design, test, or statistical analysis.

Audio Amplifier Electrical Characteristics $V_{DD} = 3V^{(1)(2)}$ (continued)

The following specifications apply for $V_{DD} = 3V$, $R_L = 16\Omega$, $A_V = 0dB$, unless otherwise specified. Limits apply for $T_A = 25^\circ C$.

Symbol	Parameter	Conditions	LM4982		Units (Limits)
			Typical ⁽³⁾	Limits ⁽⁴⁾⁽⁵⁾	
THD+N	Total Harmonic Distortion + Noise	$P_O = 50mW$, $f = 1kHz$ $R_L = 16\Omega$, single channel	0.05		%
		$P_O = 50mW$, $f = 1kHz$ $R_L = 32\Omega$, single channel	0.025		
PSRR	Power Supply Rejection Ratio Full Power Mode	$V_{RIPPLE} = 200mV_{P-P}$, input referred			dB
		$f = 217Hz$	66	56	
		$f = 1kHz$	55		
		$f = 20kHz$	40		
SNR	Signal-to-Noise-Ratio	$R_L = 32\Omega$, $P_{OUT} = 20mW$, $f = 1kHz$, BW = 20Hz to 22kHz	100		dB
T_{WU}	Wake Up Time From Shutdown	Charge Pump Wake-Up Time	300		μs
T_{WU}	Wake Up Time	Headphone Sense Debounce Time	200		ms
X_{TALK}	Crosstalk	$R_L = 16\Omega$, $P_{OUT} = 1.6mW$, $f = 1kHz$, A-weighted filter	70		dB
Z_{OUT}	Output Impedance	In Shutdown Mode	180		k Ω
I_L	Input Leakage		± 0.1		nA
V_{IH}	HPS in threshold			$0.9 \times V_{DD}$ [min]	V
V_{IL}	HPS in threshold			$0.7 \times V_{DD}$ [max]	V
R_{INT}	Intellisense Threshold Resistance		6	3 9	Ω (min) Ω (max)

Control Interface Electrical Characteristics⁽¹⁾⁽²⁾

The following specifications apply for $1.6V < V_{DD} < 4.0V$, unless otherwise specified. Limits apply for $T_A = 25^\circ C$.

Symbol	Parameter	Conditions	LM4982		Units (Limits)
			Typical ⁽³⁾	Limits ⁽⁴⁾⁽⁵⁾	
t_1	SCL period			2.5	μs (min)
t_2	SDA Setup Time			100	ns (min)
t_3	SDA Stable Time			0	ns (min)
t_4	Start Condition Time			100	ns (min)
t_5	Stop Condition Time			100	ns (min)
V_{IH}				$0.7 \times I^2CV_{DD}$	V (min)
V_{IL}				$0.3 \times I^2CV_{DD}$	V (max)

- (1) All voltages are measured with respect to the GND pin unless otherwise specified.
- (2) Absolute Maximum Ratings indicate limits beyond which damage to the device may occur. Operating Ratings indicate conditions for which the device is functional but do not ensure specific performance limits. Electrical Characteristics state DC and AC electrical specifications under particular test conditions which ensure specific performance limits. This assumes that the device is within the Operating Ratings. Specifications are not ensured for parameters where no limit is given, however, the typical value is a good indication of device performance.
- (3) Typicals are measured at $+25^\circ C$ and represent the parametric norm.
- (4) Limits are specified to Texas Instruments' AOQL (Average Outgoing Quality Level).
- (5) Datasheet min/max specification limits are specified by design, test, or statistical analysis.

Typical Performance Characteristics

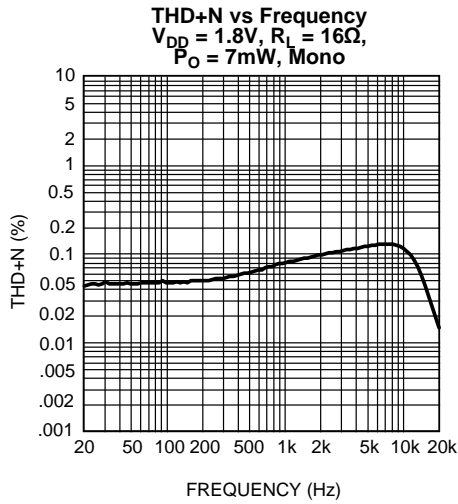

Figure 3.

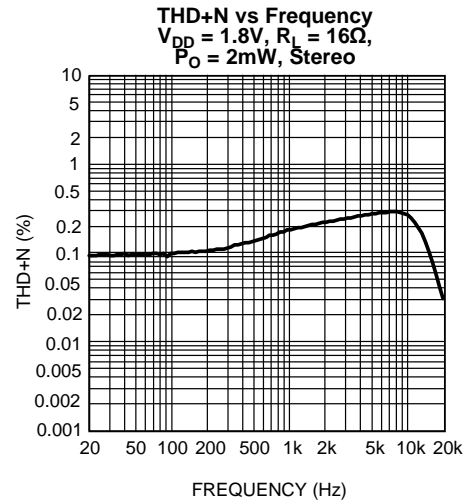

Figure 4.

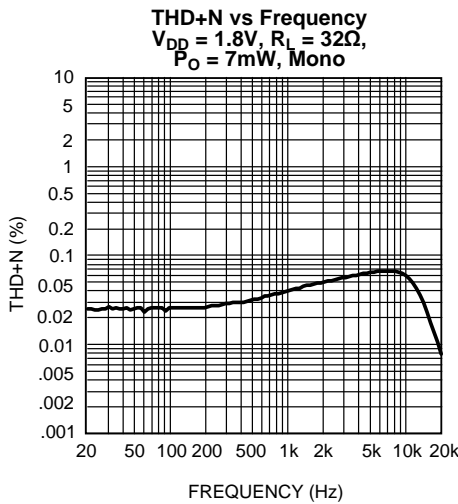

Figure 5.

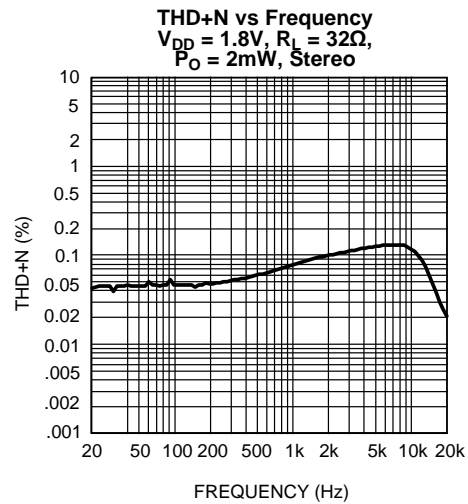

Figure 6.

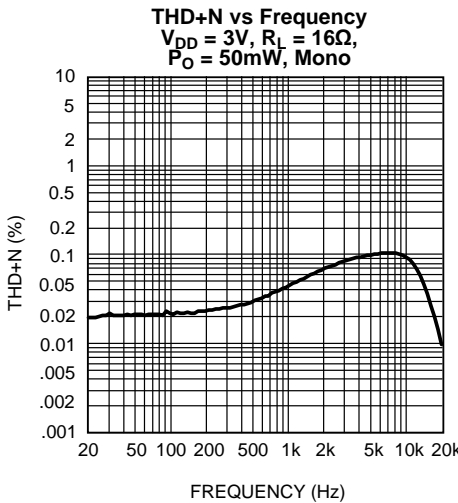

Figure 7.

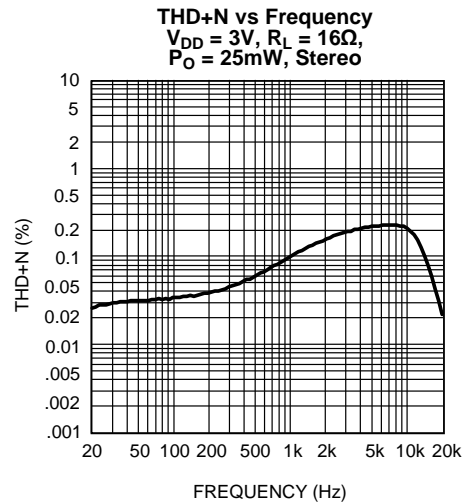

Figure 8.

Typical Performance Characteristics (continued)

THD+N vs Frequency
 $V_{DD} = 3V, R_L = 32\Omega,$
 $P_O = 50mW, \text{Mono}$

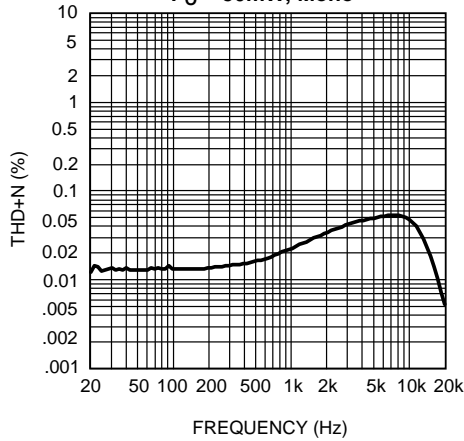

Figure 9.

THD+N vs Frequency
 $V_{DD} = 3V, R_L = 32\Omega,$
 $P_O = 25mW, \text{Stereo}$

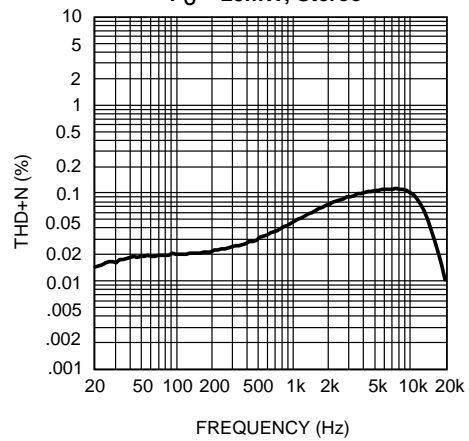

Figure 10.

THD+N vs Frequency
 $V_{DD} = 3.6V, R_L = 16\Omega,$
 $P_O = 100mW, \text{Mono}$

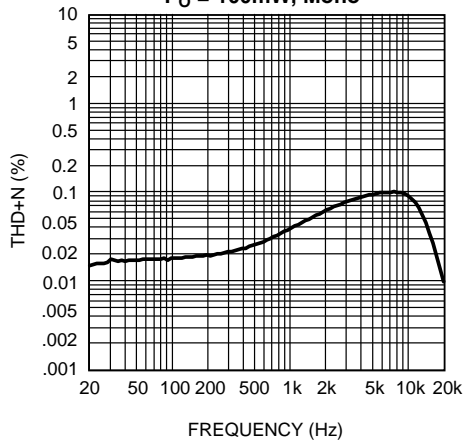

Figure 11.

THD+N vs Frequency
 $V_{DD} = 3.6V, R_L = 16\Omega,$
 $P_O = 60mW, \text{Stereo}$

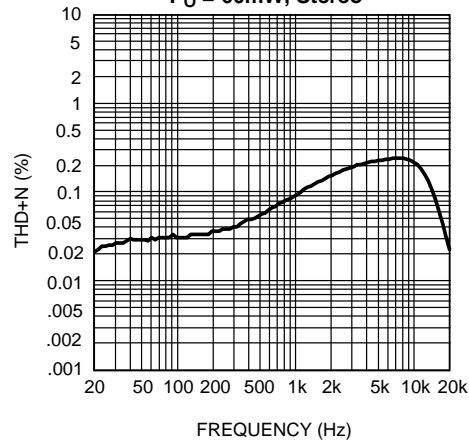

Figure 12.

THD+N vs Frequency
 $V_{DD} = 3.6V, R_L = 32\Omega,$
 $P_O = 100mW, \text{Mono}$

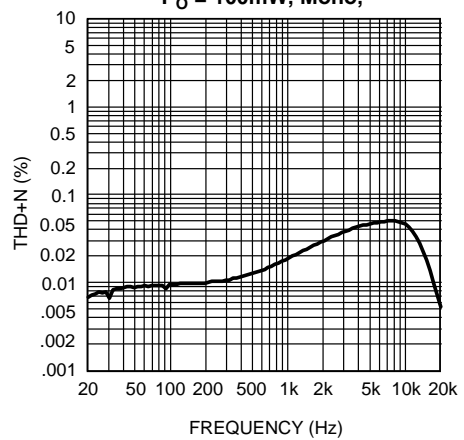

Figure 13.

THD+N vs Frequency
 $V_{DD} = 3.6V, R_L = 32\Omega,$
 $P_O = 60mW, \text{Stereo}$

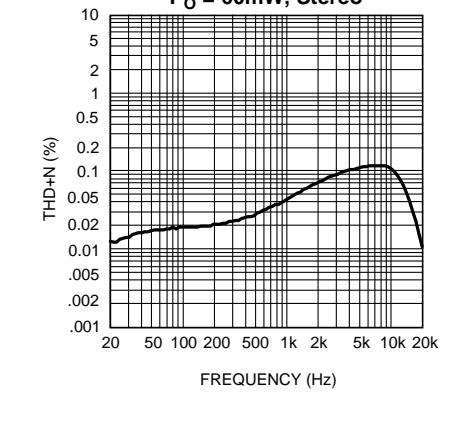

Figure 14.

Typical Performance Characteristics (continued)

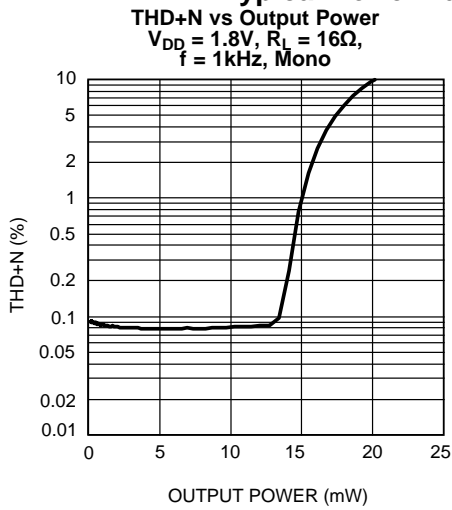

Figure 15.

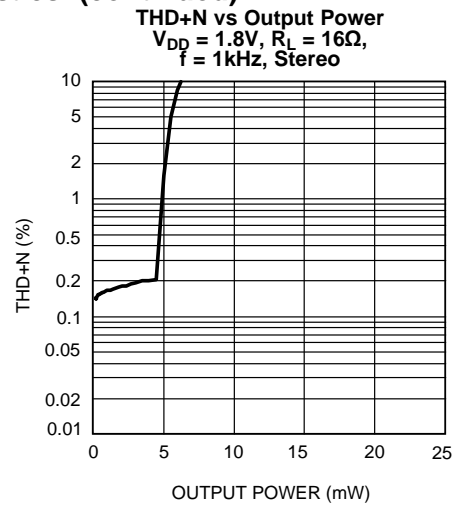

Figure 16.

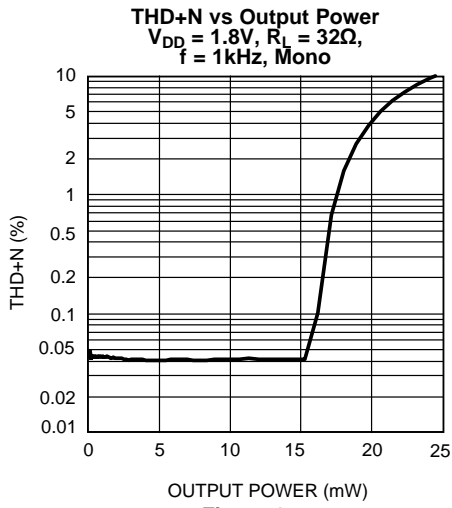

Figure 17.

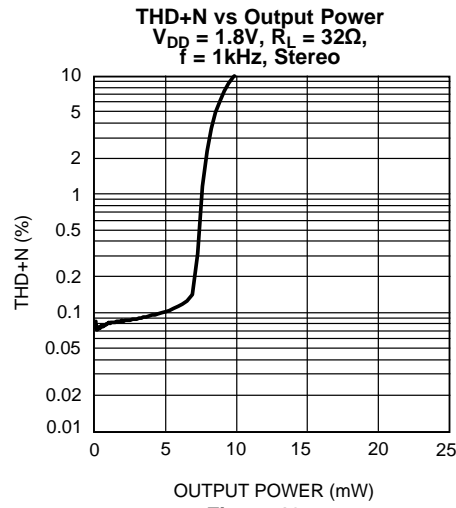

Figure 18.

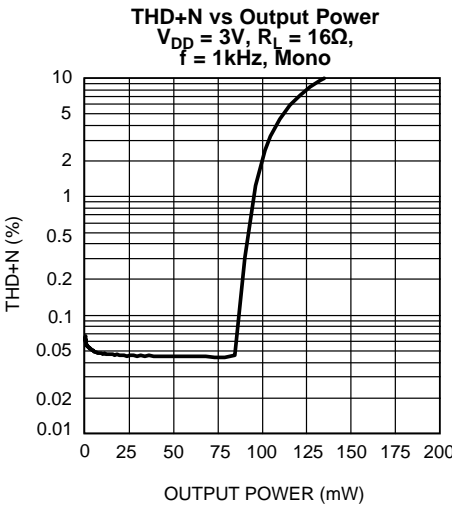

Figure 19.

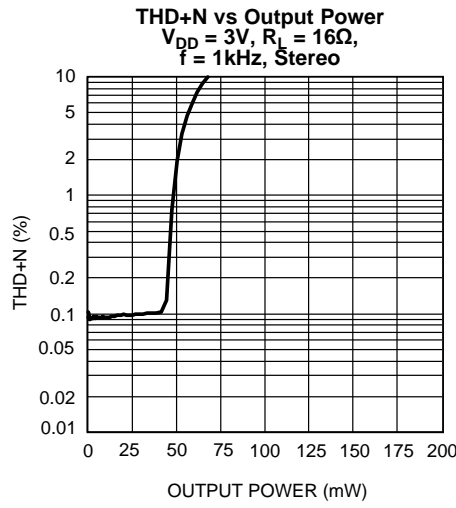

Figure 20.

Typical Performance Characteristics (continued)

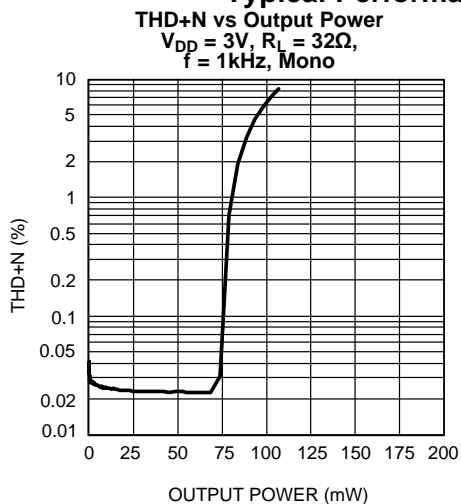

Figure 21.

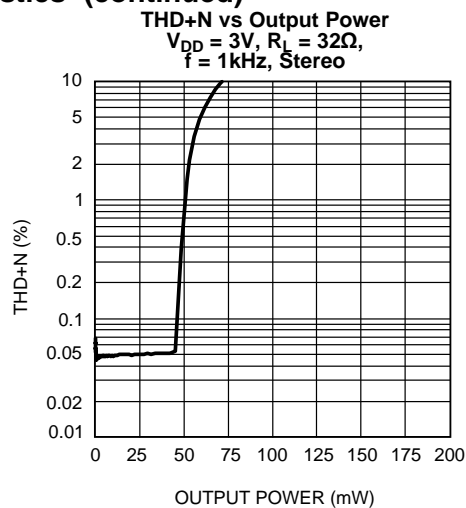

Figure 22.

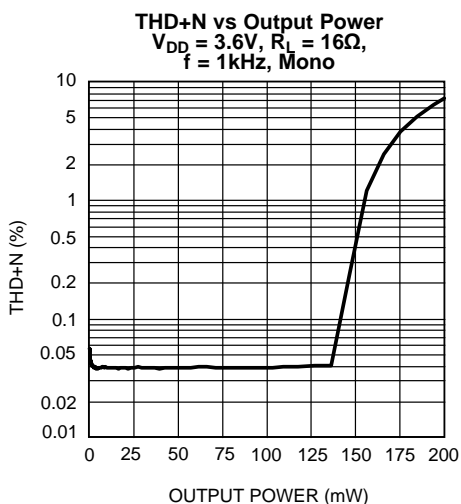

Figure 23.

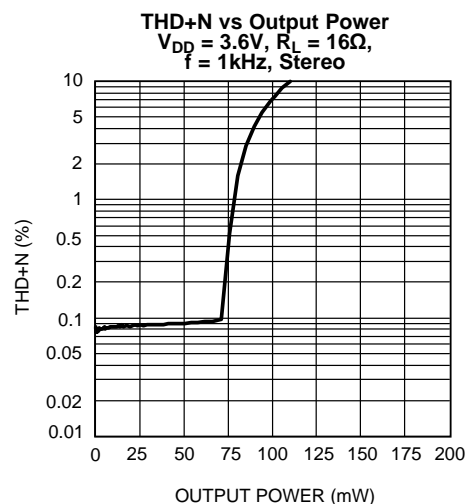

Figure 24.

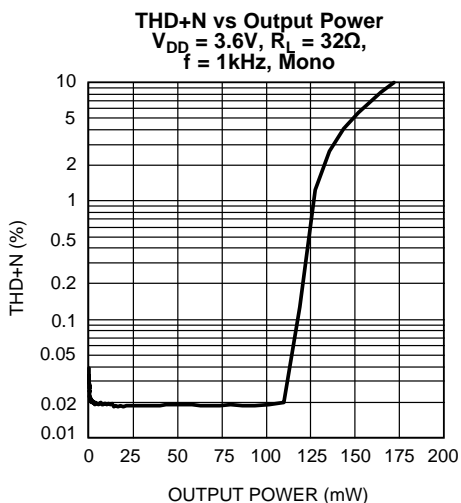

Figure 25.

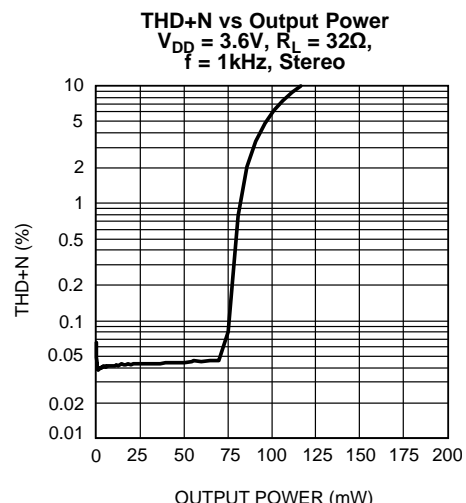

Figure 26.

Typical Performance Characteristics (continued)

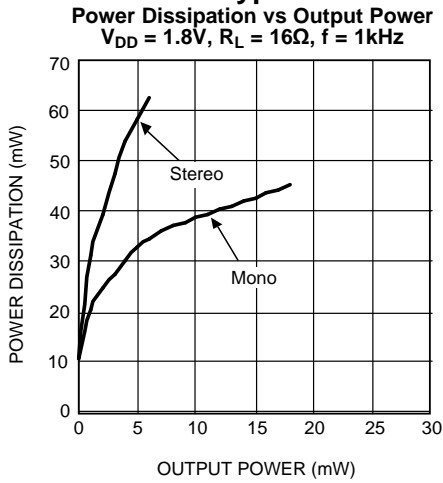

Figure 27.

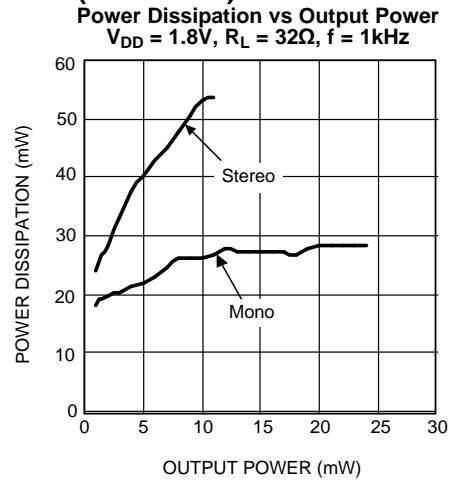

Figure 28.

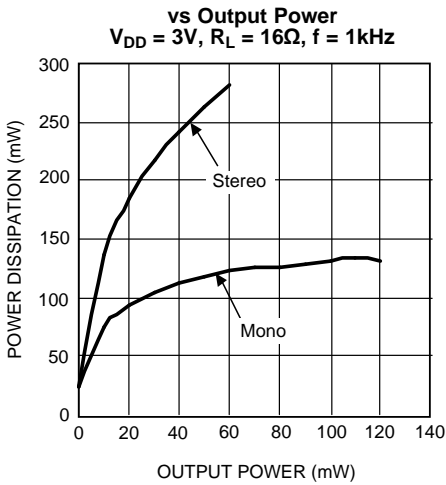

Figure 29.

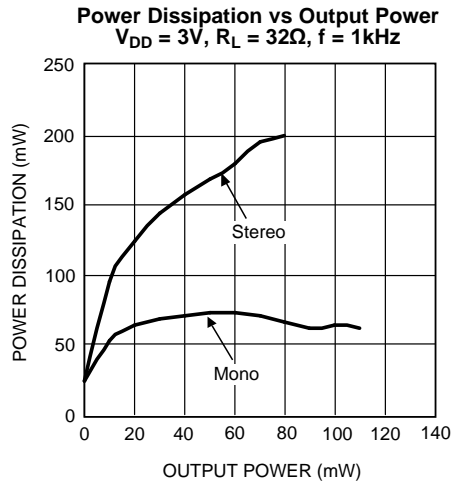

Figure 30.

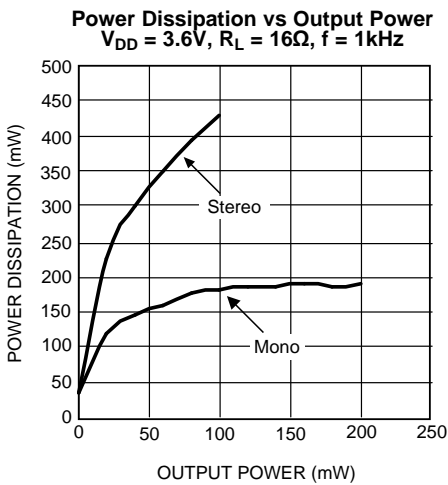

Figure 31.

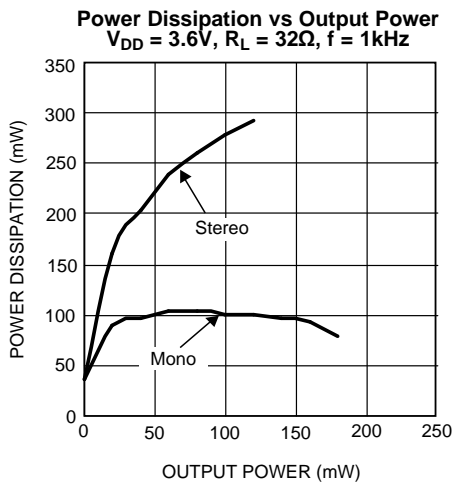

Figure 32.

Typical Performance Characteristics (continued)

Output Power vs Power Supply Voltage
 $R_L = 16\Omega, f = 1\text{kHz}, \text{Mono}$

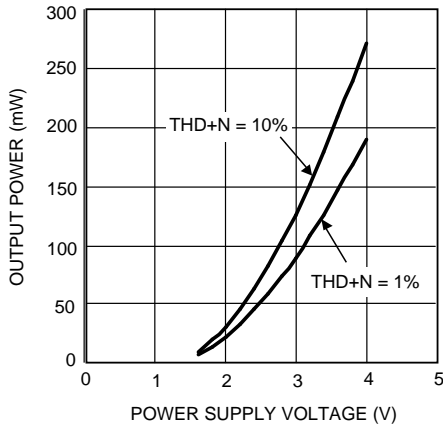

Figure 33.

Output Power vs Power Supply Voltage
 $R_L = 16\Omega, f = 1\text{kHz}, \text{Stereo}$

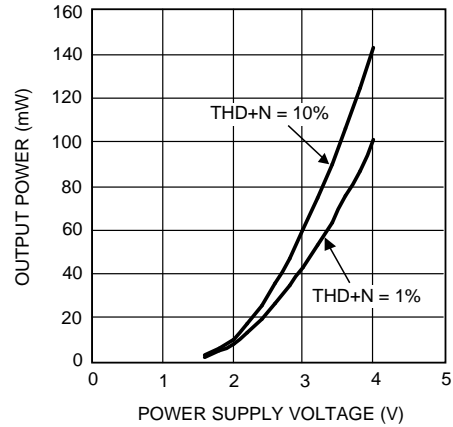

Figure 34.

Output Power vs Power Supply Voltage
 $R_L = 32\Omega, f = 1\text{kHz}, \text{Mono}$

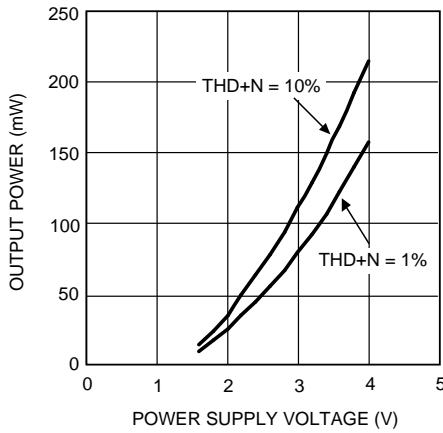

Figure 35.

Output Power vs Power Supply Voltage
 $R_L = 32\Omega, f = 1\text{kHz}, \text{Stereo}$

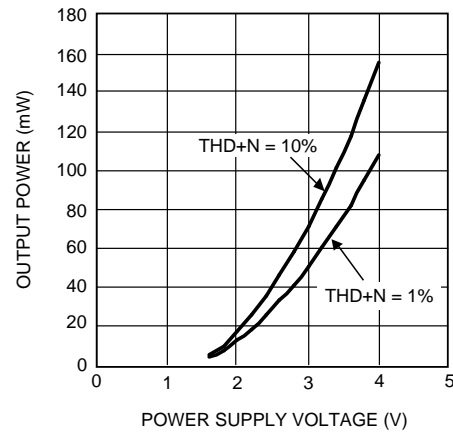

Figure 36.

Power Supply Current vs Power Supply Voltage
 $V_{IN} = 0\text{V}, \text{Mono}$

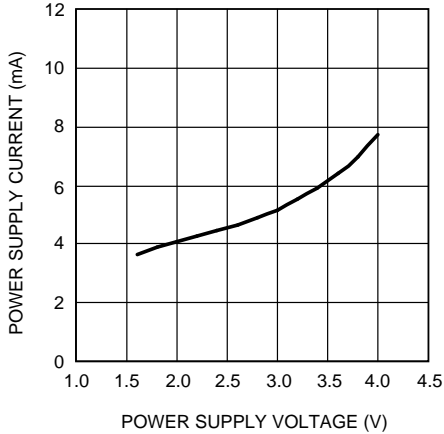

Figure 37.

Power Supply Current vs Power Supply Voltage
 $V_{IN} = 0\text{V}, \text{Stereo}$

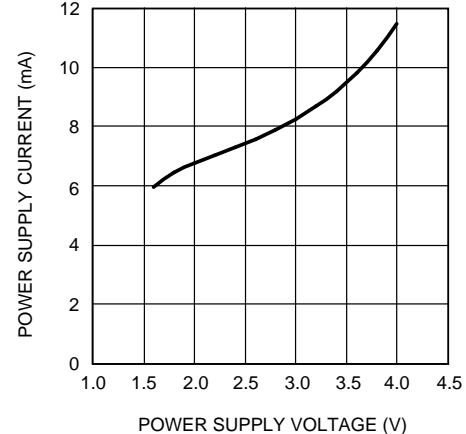

Figure 38.

Typical Performance Characteristics (continued)

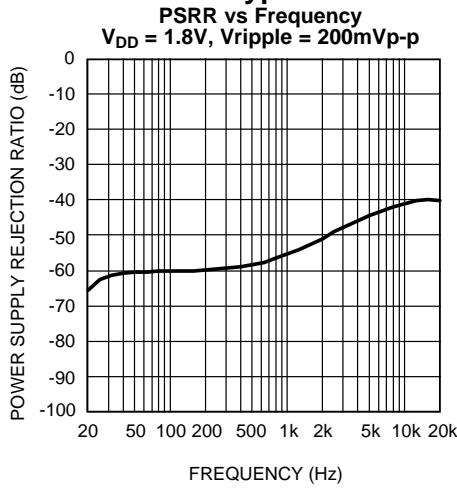

Figure 39.

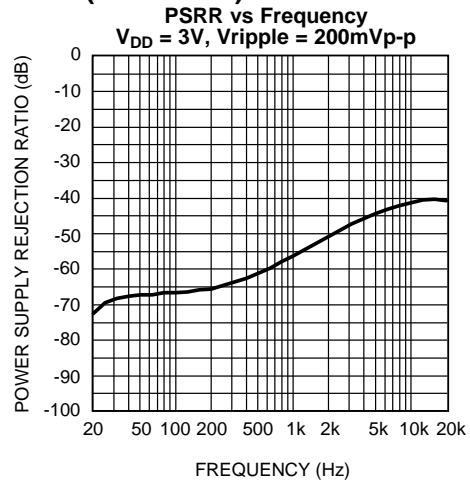

Figure 40.

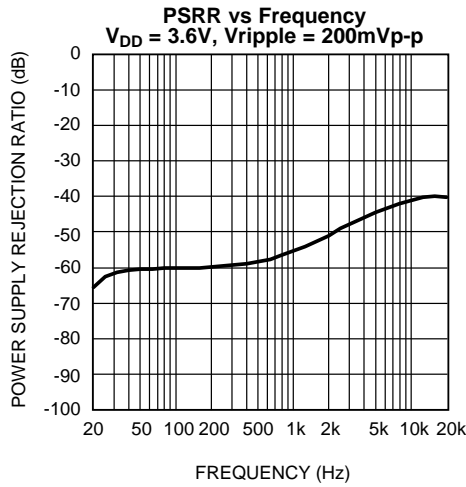

Figure 41.

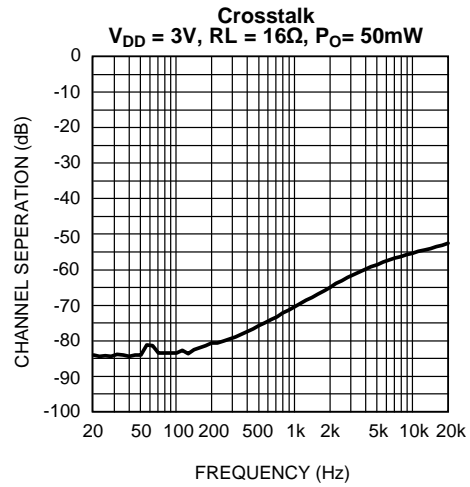

Figure 42.

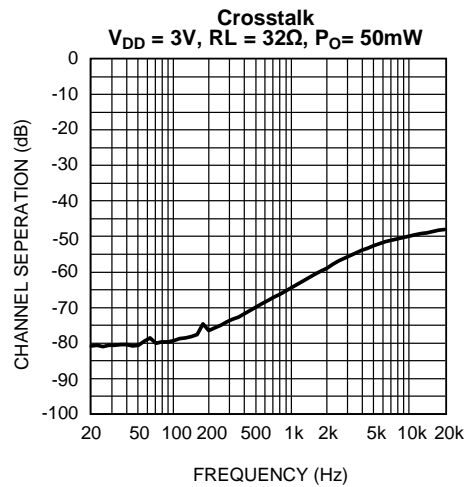

Figure 43.

APPLICATION INFORMATION

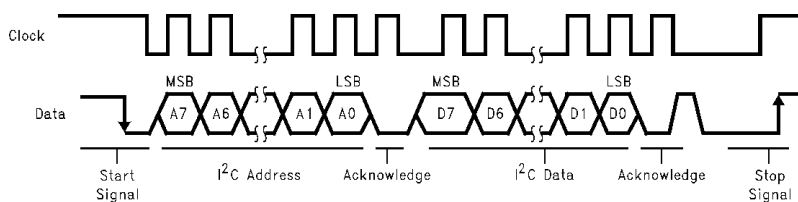

Figure 44. I²C Bus Format

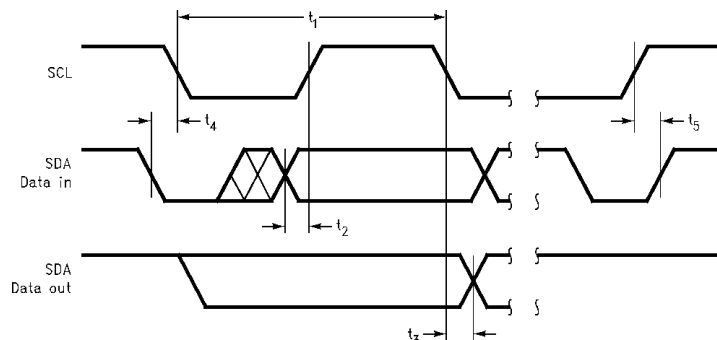

Figure 45. I²C Timing Diagram

Table 1. Chip Address

	D7	D6	D5	D4	D3	D2	D1	D0
Chip Address	1	1	1	0	1	1	0	0

Table 2. Control Registers

	D7	D6	D5	D4	D3	D2	D1	D0
Mode Control	0	0	0	0	CD3	CD2	CD1	CD0
Volume Control	1	0	0	VD4	VD3	VD2	VD1	VD0

Table 3. Mode Control

CD3	1	Intellisense Enabled
	0	Intellisense Disabled
CD2	1	Mute Enabled
	0	Mute Disabled
CD1	1	Stereo
	0	Mono *
CD0	1	Normal Operation
	0	Shutdown Enabled

I²C VOLUME CONTROL

The LM4982 can be configured in 32 different gain steps by forcing I²C volume control bits to a desired gain according to the table below:

Table 4. Volume Control

VD4	VD3	VD2	VD1	VD0	Gain (dB)
0	0	0	0	0	-70
0	0	0	0	1	-60
0	0	0	1	0	-52
0	0	0	1	1	-44
0	0	1	0	0	-38
0	0	1	0	1	-34
0	0	1	1	0	-30
0	0	1	1	1	-27
0	1	0	0	0	-24
0	1	0	0	1	-21
0	1	0	1	0	-18
0	1	0	1	1	-16
0	1	1	0	0	-14
0	1	1	0	1	-12
0	1	1	1	0	-10
0	1	1	1	1	-8
1	0	0	0	0	-6
1	0	0	0	1	-4
1	0	0	1	0	-2
1	0	0	1	1	0
1	0	1	0	0	2
1	0	1	0	1	4
1	0	1	1	0	6
1	0	1	1	1	8
1	1	0	0	0	10
1	1	0	0	1	12
1	1	0	1	0	13
1	1	0	1	1	14
1	1	1	0	0	15
1	1	1	0	1	16
1	1	1	1	0	17
1	1	1	1	1	18

HP SENSE FUNCTION

Connecting headphones to the headphone jack disconnects the headphone jack contact pin from OUT_L and allows R_{pu} to pull the HP Sense pin up to V_{DD}. This enables the device. A microprocessor or a switch can replace the headphone jack contact pin.

Shutdown (Bit CD0)	HPS pin	Operational Mode
Logic High	Logic Low	Standby Mode
Logic High	Logic High	Full Power Mode
Logic Low	Logic Low	Micro-Power Shutdown
Logic Low	Logic High	Micro-Power Shutdown

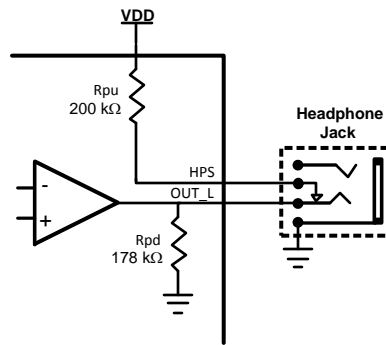

INTELLISENSE

Texas Instruments' Intellisense technology allows the LM4982 to detect whether a mono or stereo headphone has been inserted into the headphone jack. If a mono headphone is inserted into a device that is designed for a stereo headphone, one of the amplifiers will be shorted to ground. Without Intellisense, this may damage the device or, best case, the device will draw excessive current, shortening battery life.

Intellisense works by first waiting for one of the following events:

- When the device powers up, if a headphone is already inserted
- When a headphone is inserted, if the device is already powered up
- After the thermal shutdown circuitry is activated.

The occurrence of one of these events triggers the Intellisense circuitry to apply a small voltage on both left and right outputs and sense the resulting current through the load. If the load connected to the amplifier is greater than 9Ω , the amplifier driving it will be in full power mode. If the load is less than 3Ω , the LM4982 will assume a short to ground and shutdown the driving amplifier. Intellisense puts the LM4982 in mono mode when the right channel is shorted. For extra protection both amplifiers will be shutdown when the left channel is shorted to ground. The Intellisense feature can be enabled and disabled through an I2C command.

This Intellisense feature is designed for headphones with a nominal impedance of 16Ω or greater, using lower impedance loads may cause this feature to operate incorrectly.

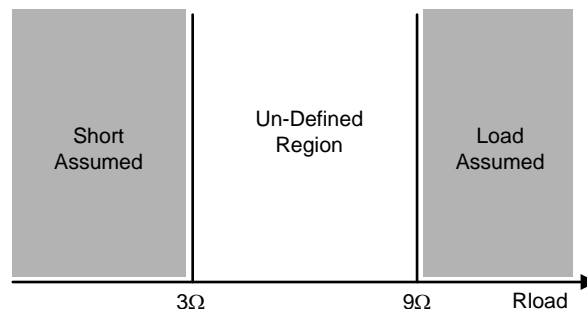

MONO/STEREO OPERATION

When Intellisense is disabled the value of the CD1 bit of the mode control determines if the LM4982 is in mono or stereo mode. When the LM4982 is in mono mode the left and right input signals are mixed to the left channel amplifier and attenuated by -6dB . The right channel amplifier is put in shutdown to save power. The mixing function allows full reproduction of a stereo input signal in a mono headphone and optimum headroom is kept by attenuating by a factor of two.

I²C COMPATIBLE INTERFACE

The LM4982 uses a serial bus, which conforms to the I²C protocol, to control the chip's functions with two wires: clock (SCL) and data (SDA). The clock line is uni-directional. The data line is bi-directional (open-collector). The maximum clock frequency specified by the I²C standard is 400kHz. In this discussion, the master is the controlling microcontroller and the slave is the LM4982.

The bus format for the I²C interface is shown in [Figure 44](#). The bus format diagram is broken up into six major sections:

The "start" signal is generated by lowering the data signal while the clock signal is high. The start signal will alert all devices attached to the I²C bus to check the incoming address against their own address.

The 8-bit chip address is sent next, most significant bit first. The data is latched in on the rising edge of the clock. Each address bit must be stable while the clock level is high.

After the last bit of the address bit is sent, the master releases the data line high (through a pull-up resistor). Then the master sends an acknowledge clock pulse. If the LM4982 has received the address correctly, then it holds the data line low during the clock pulse. If the data line is not held low during the acknowledge clock pulse, then the master should abort the rest of the data transfer to the LM4982.

The 8 bits of data are sent next, most significant bit first. Each data bit should be valid while the clock level is stable high.

After the data byte is sent, the master must check for another acknowledge to see if the LM4982 received the data.

If the master has more data bytes to send to the LM4982, then the master can repeat the previous two steps until all data bytes have been sent.

The "stop" signal ends the transfer. To signal "stop", the data signal goes high while the clock signal is high. The data line should be held high when not in use.

I²C INTERFACE POWER SUPPLY PIN (I²CV_{DD})

The LM4982's I²C interface is powered up through the I²CV_{DD} pin. The LM4982's I²C interface operates at a voltage level set by the I²CV_{DD} pin which can be set independent to that of the main power supply pin V_{DD}. This is ideal whenever logic levels for the I²C interface are dictated by a microcontroller or microprocessor that is operating at a lower supply voltage than the main battery of a portable system.

POWER SUPPLY BYPASSING

As with any power amplifier, proper supply bypassing is critical for low noise performance and high power supply rejection. Applications that employ a 5V regulator typically use a 10 μ F in parallel with a 0.1 μ F filter capacitors to stabilize the regulator's output, reduce noise on the supply line, and improve the supply's transient response. However, their presence does not eliminate the need for a local 1.0 μ F tantalum bypass capacitance connected between the LM4982's supply pins and ground. Keep the length of leads and traces that connect capacitors between the LM4982's power supply pins and ground as short as possible.

ELIMINATING THE OUTPUT COUPLING CAPACITOR

The LM4982 features a low noise inverting charge pump that generates an internal negative supply voltage. This allows the outputs of the LM4982 to be biased about GND instead of a nominal DC voltage, like traditional headphone amplifiers. Because there is no DC component, the large DC blocking capacitors (typically 220 μ F) are not necessary. The coupling capacitors are replaced by two, small ceramic charge pump capacitors, saving board space and cost.

Eliminating the output coupling capacitors also improves low frequency response. In traditional headphone amplifiers, the headphone impedance and the output capacitor form a high pass filter that not only blocks the DC component of the output, but also attenuates low frequencies, impacting the bass response. Because the LM4982 does not require the output coupling capacitors, the low frequency response of the device is not degraded by external components.

In addition to eliminating the output coupling capacitors, the ground referenced output nearly doubles the available dynamic range of the LM4982 when compared to a traditional headphone amplifier operating from the same supply voltage.

OUTPUT TRANSIENT ('CLICK AND POPS') ELIMINATED

The LM4982 contains advanced circuitry that virtually eliminates output transients ('clicks and pops'). This circuitry prevents all traces of transients when the supply voltage is first applied or when the part resumes operation after coming out of shutdown mode.

POWER DISSIPATION

Power dissipation is a major concern when using any power amplifier and must be thoroughly understood to ensure a successful design. Equation 1 states the maximum power dissipation point for a single-ended amplifier operating at a given supply voltage and driving a specified output load.

$$P_{\text{DMAX}} = (2V_{\text{DD}})^2 / (2\pi^2 R_L) \quad (1)$$

Since the LM4982 has two operational amplifiers in one package, the maximum internal power dissipation point is twice that of the number which results from Equation 1. Even with large internal power dissipation, the LM4982 does not require heat sinking over a large range of ambient temperatures. The maximum power dissipation point obtained must not be greater than the power dissipation that results from Equation 2:

$$P_{\text{DMAX}} = (T_{\text{JMAX}} - T_A) / (\theta_{\text{JA}}) \quad (2)$$

For the DSBGA package, $\theta_{\text{JA}} = 105^\circ\text{C/W}$. $T_{\text{JMAX}} = 150^\circ\text{C}$ for the LM4982. Depending on the ambient temperature, T_A , of the system surroundings, Equation 2 can be used to find the maximum internal power dissipation supported by the IC packaging. If the result of Equation 1 is greater than that of Equation 2, then either the supply voltage must be decreased, the load impedance increased or T_A reduced. Power dissipation is a function of output power and thus, if typical operation is not around the maximum power dissipation point, the ambient temperature may be increased accordingly.

SELECTING PROPER EXTERNAL COMPONENTS

Optimizing the LM4982's performance requires properly selecting external components. Though the LM4982 operates well when using external components with wide tolerances, best performance is achieved by optimizing component values.

Charge Pump Capacitor Selection

Use low ESR (equivalent series resistance) (<100mΩ) ceramic capacitors with an X7R dielectric for best performance. Low ESR capacitors keep the charge pump output impedance to a minimum, extending the headroom on the negative supply. Higher ESR capacitors result in reduced output power from the audio amplifiers.

Charge pump load regulation and output impedance are affected by the value of the flying capacitor (C1). A larger valued C1 (up to 3.3uF) improves load regulation and minimizes charge pump output resistance. Beyond 3.3uF, the switch-on resistance dominates the output impedance for capacitor values above 2.2uF.

The output ripple is affected by the value and ESR of the output capacitor (C2). Larger capacitors reduce output ripple on the negative power supply. Lower ESR capacitors minimize the output ripple and reduce the output impedance of the charge pump.

The LM4982 charge pump design is optimized for 2.2uF, low ESR, ceramic, flying, and output capacitors.

Input Capacitor Value Selection

Amplifying the lowest audio frequencies requires high value input coupling capacitors (C_i in Figure 1). A high value capacitor can be expensive and may compromise space efficiency in portable designs. In many cases, however, the speakers used in portable systems, whether internal or external, have little ability to reproduce signals below 150Hz. Applications using speakers with this limited frequency response reap little improvement by using high value input and output capacitors.

Besides affecting system cost and size, C_i has an effect on the LM4982's click and pop performance. The magnitude of the pop is directly proportional to the input capacitor's size. Thus, pops can be minimized by selecting an input capacitor value that is no higher than necessary to meet the desired -3dB frequency.

As shown in Figure 1, the internal input resistor, R_i and the input capacitor, C_i , produce a -3dB high pass filter cutoff frequency that is found using Equation 3. Conventional headphone amplifiers require output capacitors; Equation 3 can be used, along with the value of R_L , to determine towards the value of output capacitor needed to produce a -3dB high pass filter cutoff frequency.

$$f_{i-3\text{dB}} = 1 / 2\pi R_i C_i \quad (3)$$

Also, careful consideration must be taken in selecting a certain type of capacitor to be used in the system. Different types of capacitors (tantalum, electrolytic, ceramic) have unique performance characteristics and may affect overall system performance. (See the section entitled Charge Pump Capacitor Selection.)

Demo Board Artwork

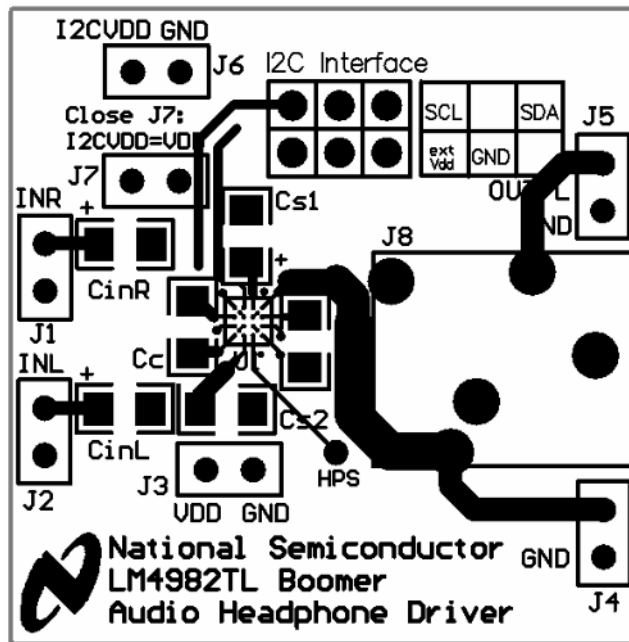

Figure 46. Top Layer

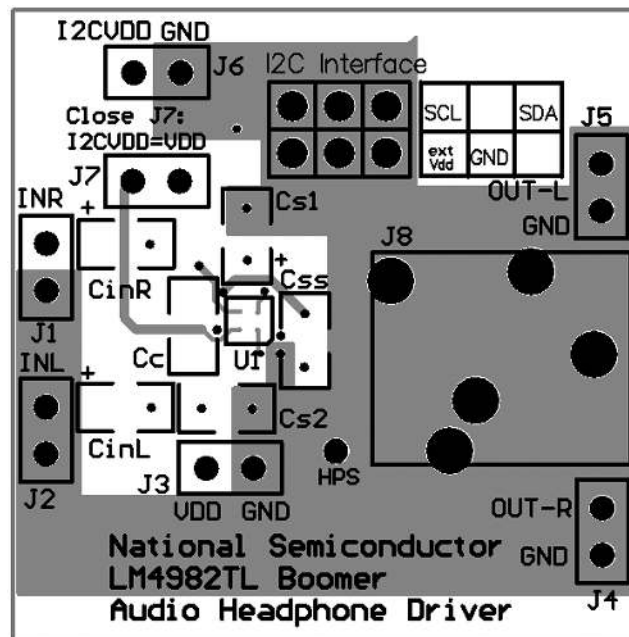

Figure 47. Mid Layer 1

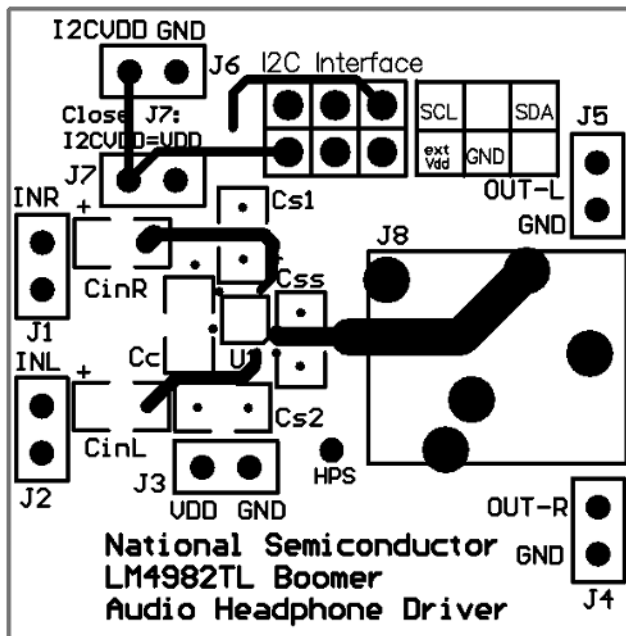

Figure 48. Mid Layer 2

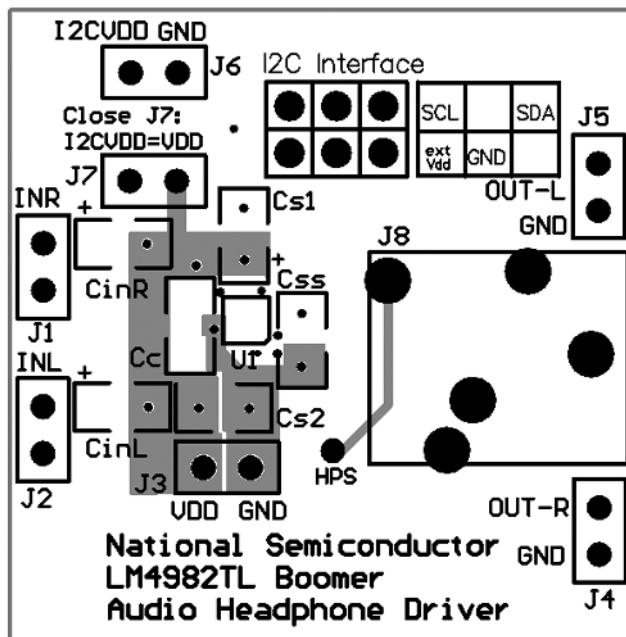

Figure 49. Bottom Layer

REVISION HISTORY

Rev	Date	Description
1.0	2/09/06	Initial WEB release.
1.1	7/27/06	Edited the mktg outline descriptions (X1, X2, and X3), then re-released the D/S to the WEB per Nisha P.

Changes from Revision A (April 2013) to Revision B

Page

- Changed layout of National Data Sheet to TI format [19](#)

PACKAGING INFORMATION

Orderable Device	Status (1)	Package Type	Package Drawing	Pins	Package Qty	Eco Plan (2)	Lead/Ball Finish	MSL Peak Temp (3)	Op Temp (°C)	Top-Side Markings (4)	Samples
LM4982TL/NOPB	ACTIVE	DSBGA	YZR	16	250	Green (RoHS & no Sb/Br)	SNAGCU	Level-1-260C-UNLIM	-40 to 85	GG3	Samples
LM4982TLX/NOPB	ACTIVE	DSBGA	YZR	16	3000	Green (RoHS & no Sb/Br)	SNAGCU	Level-1-260C-UNLIM	-40 to 85	GG3	Samples

(1) The marketing status values are defined as follows:

ACTIVE: Product device recommended for new designs.

LIFEBUY: TI has announced that the device will be discontinued, and a lifetime-buy period is in effect.

NRND: Not recommended for new designs. Device is in production to support existing customers, but TI does not recommend using this part in a new design.

PREVIEW: Device has been announced but is not in production. Samples may or may not be available.

OBSOLETE: TI has discontinued the production of the device.

(2) Eco Plan - The planned eco-friendly classification: Pb-Free (RoHS), Pb-Free (RoHS Exempt), or Green (RoHS & no Sb/Br) - please check <http://www.ti.com/productcontent> for the latest availability information and additional product content details.

TBD: The Pb-Free/Green conversion plan has not been defined.

Pb-Free (RoHS): TI's terms "Lead-Free" or "Pb-Free" mean semiconductor products that are compatible with the current RoHS requirements for all 6 substances, including the requirement that lead not exceed 0.1% by weight in homogeneous materials. Where designed to be soldered at high temperatures, TI Pb-Free products are suitable for use in specified lead-free processes.

Pb-Free (RoHS Exempt): This component has a RoHS exemption for either 1) lead-based flip-chip solder bumps used between the die and package, or 2) lead-based die adhesive used between the die and leadframe. The component is otherwise considered Pb-Free (RoHS compatible) as defined above.

Green (RoHS & no Sb/Br): TI defines "Green" to mean Pb-Free (RoHS compatible), and free of Bromine (Br) and Antimony (Sb) based flame retardants (Br or Sb do not exceed 0.1% by weight in homogeneous material)

(3) MSL, Peak Temp. -- The Moisture Sensitivity Level rating according to the JEDEC industry standard classifications, and peak solder temperature.

(4) Multiple Top-Side Markings will be inside parentheses. Only one Top-Side Marking contained in parentheses and separated by a "~" will appear on a device. If a line is indented then it is a continuation of the previous line and the two combined represent the entire Top-Side Marking for that device.

Important Information and Disclaimer: The information provided on this page represents TI's knowledge and belief as of the date that it is provided. TI bases its knowledge and belief on information provided by third parties, and makes no representation or warranty as to the accuracy of such information. Efforts are underway to better integrate information from third parties. TI has taken and continues to take reasonable steps to provide representative and accurate information but may not have conducted destructive testing or chemical analysis on incoming materials and chemicals. TI and TI suppliers consider certain information to be proprietary, and thus CAS numbers and other limited information may not be available for release.

In no event shall TI's liability arising out of such information exceed the total purchase price of the TI part(s) at issue in this document sold by TI to Customer on an annual basis.

TAPE AND REEL INFORMATION

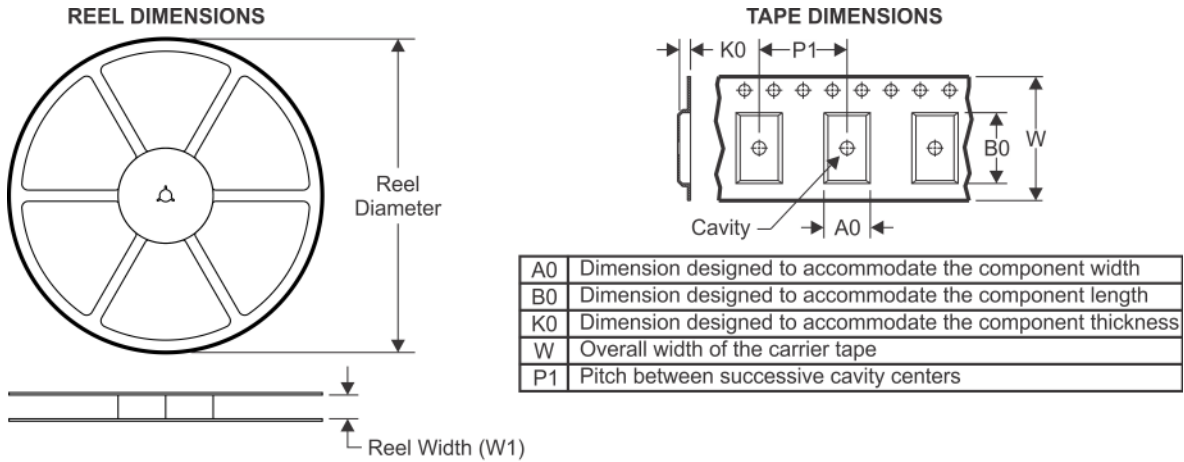

QUADRANT ASSIGNMENTS FOR PIN 1 ORIENTATION IN TAPE

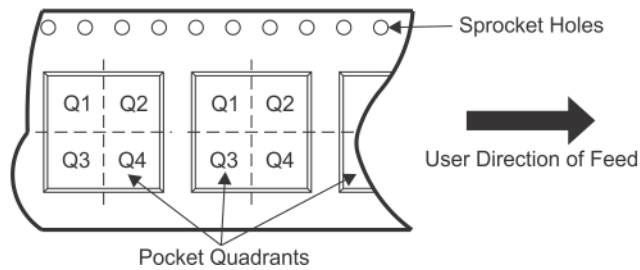

*All dimensions are nominal

Device	Package Type	Package Drawing	Pins	SPQ	Reel Diameter (mm)	Reel Width W1 (mm)	A0 (mm)	B0 (mm)	K0 (mm)	P1 (mm)	W (mm)	Pin1 Quadrant
LM4982TL/NOPB	DSBGA	YZR	16	250	178.0	8.4	2.08	2.08	0.76	4.0	8.0	Q1
LM4982TLX/NOPB	DSBGA	YZR	16	3000	178.0	8.4	2.08	2.08	0.76	4.0	8.0	Q1

TAPE AND REEL BOX DIMENSIONS

*All dimensions are nominal

Device	Package Type	Package Drawing	Pins	SPQ	Length (mm)	Width (mm)	Height (mm)
LM4982TL/NOPB	DSBGA	YZR	16	250	210.0	185.0	35.0
LM4982TLX/NOPB	DSBGA	YZR	16	3000	210.0	185.0	35.0

YZR0016

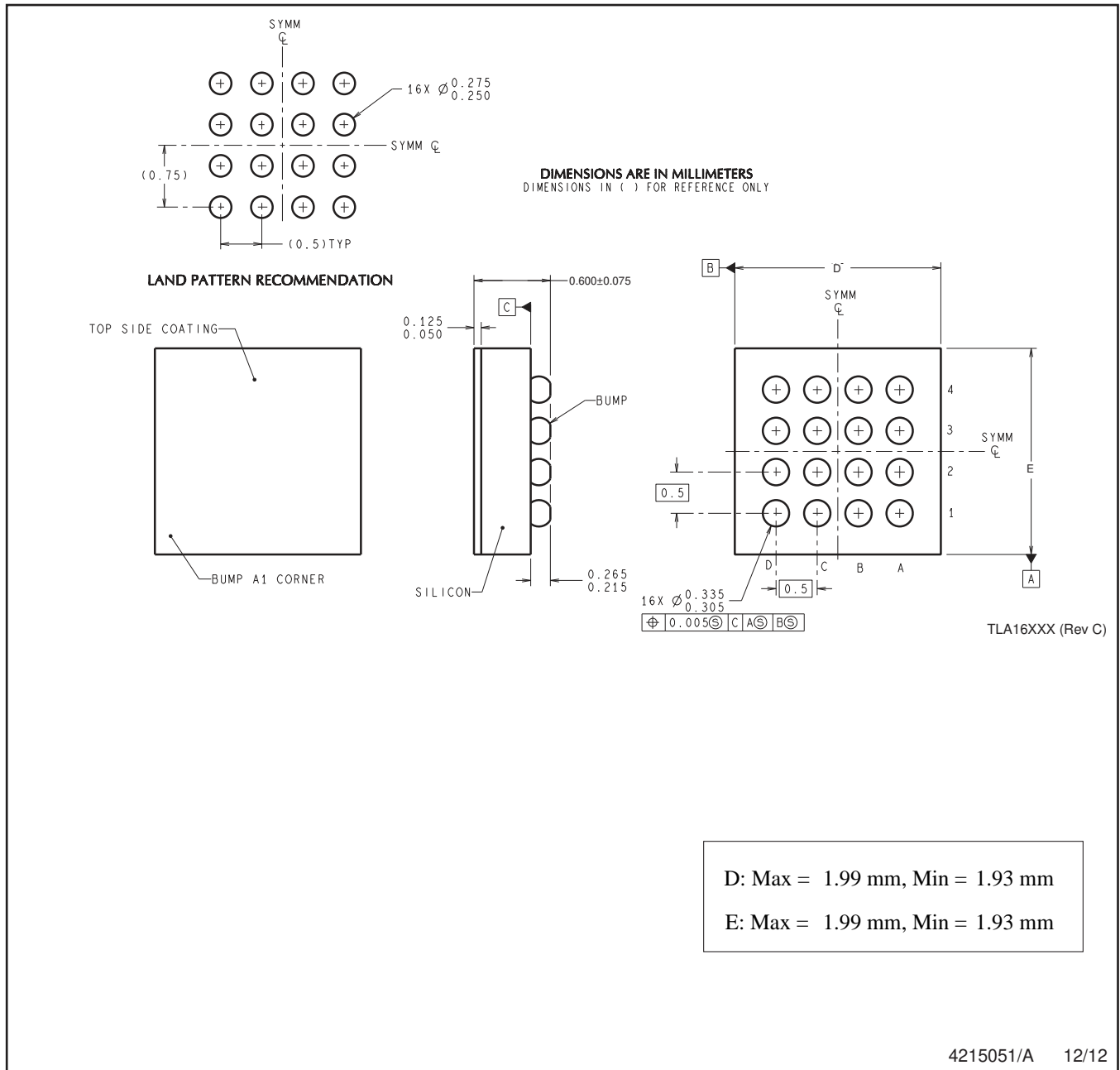

4215051/A 12/12

NOTES: A. All linear dimensions are in millimeters. Dimensioning and tolerancing per ASME Y14.5M-1994.
B. This drawing is subject to change without notice.

IMPORTANT NOTICE

Texas Instruments Incorporated and its subsidiaries (TI) reserve the right to make corrections, enhancements, improvements and other changes to its semiconductor products and services per JESD46, latest issue, and to discontinue any product or service per JESD48, latest issue. Buyers should obtain the latest relevant information before placing orders and should verify that such information is current and complete. All semiconductor products (also referred to herein as "components") are sold subject to TI's terms and conditions of sale supplied at the time of order acknowledgment.

TI warrants performance of its components to the specifications applicable at the time of sale, in accordance with the warranty in TI's terms and conditions of sale of semiconductor products. Testing and other quality control techniques are used to the extent TI deems necessary to support this warranty. Except where mandated by applicable law, testing of all parameters of each component is not necessarily performed.

TI assumes no liability for applications assistance or the design of Buyers' products. Buyers are responsible for their products and applications using TI components. To minimize the risks associated with Buyers' products and applications, Buyers should provide adequate design and operating safeguards.

TI does not warrant or represent that any license, either express or implied, is granted under any patent right, copyright, mask work right, or other intellectual property right relating to any combination, machine, or process in which TI components or services are used. Information published by TI regarding third-party products or services does not constitute a license to use such products or services or a warranty or endorsement thereof. Use of such information may require a license from a third party under the patents or other intellectual property of the third party, or a license from TI under the patents or other intellectual property of TI.

Reproduction of significant portions of TI information in TI data books or data sheets is permissible only if reproduction is without alteration and is accompanied by all associated warranties, conditions, limitations, and notices. TI is not responsible or liable for such altered documentation. Information of third parties may be subject to additional restrictions.

Resale of TI components or services with statements different from or beyond the parameters stated by TI for that component or service voids all express and any implied warranties for the associated TI component or service and is an unfair and deceptive business practice. TI is not responsible or liable for any such statements.

Buyer acknowledges and agrees that it is solely responsible for compliance with all legal, regulatory and safety-related requirements concerning its products, and any use of TI components in its applications, notwithstanding any applications-related information or support that may be provided by TI. Buyer represents and agrees that it has all the necessary expertise to create and implement safeguards which anticipate dangerous consequences of failures, monitor failures and their consequences, lessen the likelihood of failures that might cause harm and take appropriate remedial actions. Buyer will fully indemnify TI and its representatives against any damages arising out of the use of any TI components in safety-critical applications.

In some cases, TI components may be promoted specifically to facilitate safety-related applications. With such components, TI's goal is to help enable customers to design and create their own end-product solutions that meet applicable functional safety standards and requirements. Nonetheless, such components are subject to these terms.

No TI components are authorized for use in FDA Class III (or similar life-critical medical equipment) unless authorized officers of the parties have executed a special agreement specifically governing such use.

Only those TI components which TI has specifically designated as military grade or "enhanced plastic" are designed and intended for use in military/aerospace applications or environments. Buyer acknowledges and agrees that any military or aerospace use of TI components which have **not** been so designated is solely at the Buyer's risk, and that Buyer is solely responsible for compliance with all legal and regulatory requirements in connection with such use.

TI has specifically designated certain components as meeting ISO/TS16949 requirements, mainly for automotive use. In any case of use of non-designated products, TI will not be responsible for any failure to meet ISO/TS16949.

Products

Audio	www.ti.com/audio
Amplifiers	amplifier.ti.com
Data Converters	dataconverter.ti.com
DLP® Products	www.dlp.com
DSP	dsp.ti.com
Clocks and Timers	www.ti.com/clocks
Interface	interface.ti.com
Logic	logic.ti.com
Power Mgmt	power.ti.com
Microcontrollers	microcontroller.ti.com
RFID	www.ti-rfid.com
OMAP Applications Processors	www.ti.com/omap
Wireless Connectivity	www.ti.com/wirelessconnectivity

Applications

Automotive and Transportation	www.ti.com/automotive
Communications and Telecom	www.ti.com/communications
Computers and Peripherals	www.ti.com/computers
Consumer Electronics	www.ti.com/consumer-apps
Energy and Lighting	www.ti.com/energy
Industrial	www.ti.com/industrial
Medical	www.ti.com/medical
Security	www.ti.com/security
Space, Avionics and Defense	www.ti.com/space-avionics-defense
Video and Imaging	www.ti.com/video

TI E2E Community

e2e.ti.com