

## LARISA-O-CLIP8

~40° x 20° oval beam. Clip fastening for 0.8 mm thick PCB.

### SPECIFICATION:

Dimensions	9.9 x 9.9 mm
Height	7.5 mm
Fastening	clips
ROHS compliant	yes ⓘ



### MATERIALS:

Component	Type	Material	Colour	Finish
LARISA-O	Single lens	PMMA	clear	
LARISA-HOLDER-CLIP8	Holder	PC	black	

### ORDERING INFORMATION:

Component		Qty in box	MOQ	MPQ	Box weight (kg)
CP12942_LARISA-O-CLIP8	Single lens	10000	300	100	6.8
» Box size: 300 x 250 x 250 mm					

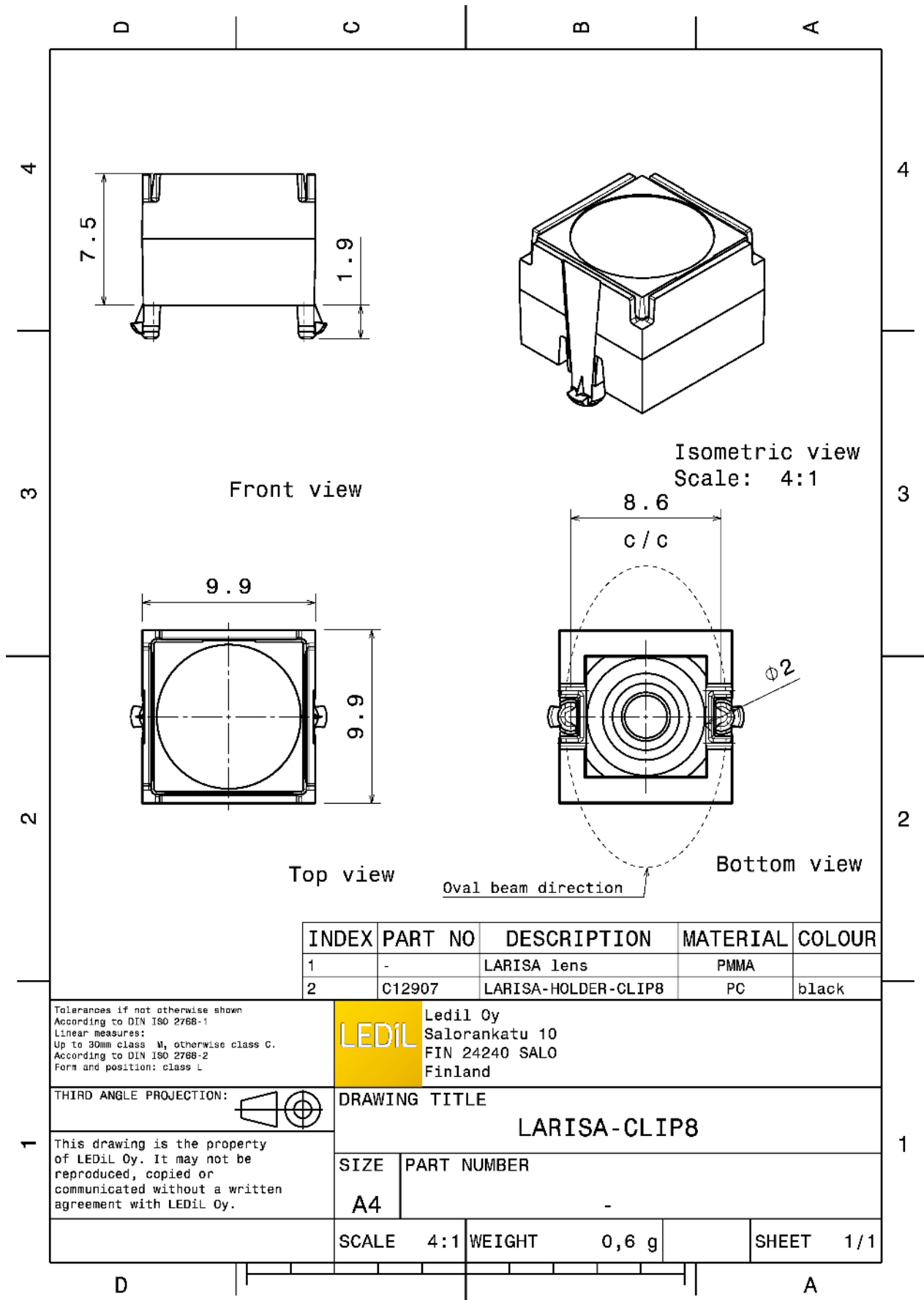

See also our general installation guide: [www.ledil.com/installation\\_guide](http://www.ledil.com/installation_guide)

#### OPTICAL RESULTS (MEASURED):

##### CREE ⇄ LED

LED XB-D  
 FWHM / FWTM 39.0 + 21.0° / 73.0 + 49.0°  
 Efficiency 79 %  
 Peak intensity 2.2 cd/lm  
 LEDs/each optic 1  
 Light colour White  
 Required components:

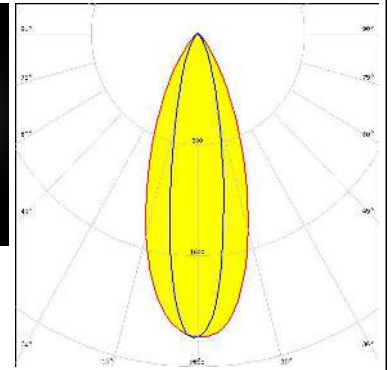
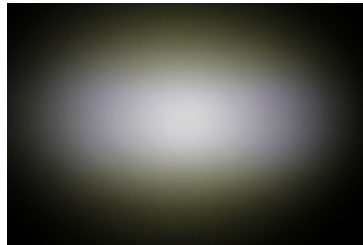

##### CREE ⇄ LED

LED XD16  
 FWHM / FWTM 40.0 + 20.0° / 72.0 + 51.0°  
 Efficiency 75 %  
 Peak intensity 2.1 cd/lm  
 LEDs/each optic 1  
 Light colour White  
 Required components:

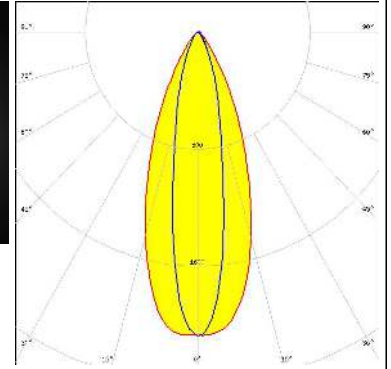

##### CREE ⇄ LED

LED XP-G  
 FWHM / FWTM 39.0 + 25.0° / 76.0 + 51.0°  
 Efficiency 83 %  
 Peak intensity 2.1 cd/lm  
 LEDs/each optic 1  
 Light colour White  
 Required components:

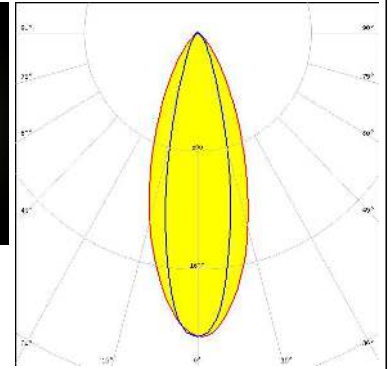



##### CREE ⇄ LED

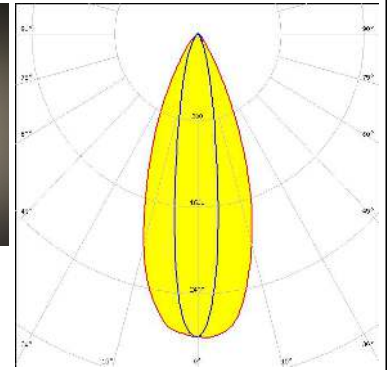
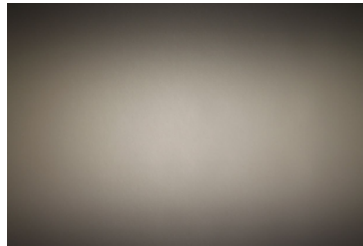

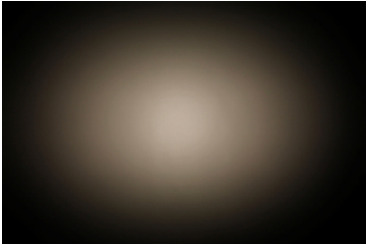
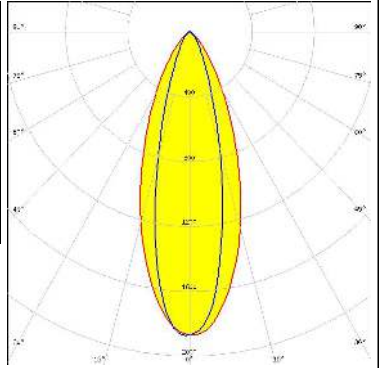

LED XQ-E HD  
 FWHM / FWTM 40.0 + 17.0° / 68.0 + 42.0°  
 Efficiency 82 %  
 Peak intensity 2.8 cd/lm  
 LEDs/each optic 1  
 Light colour White  
 Required components:

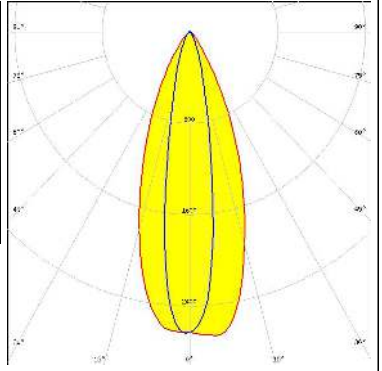
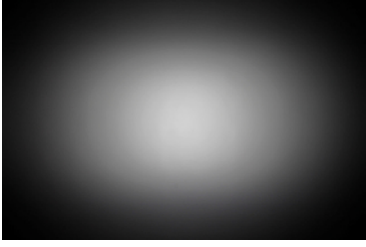
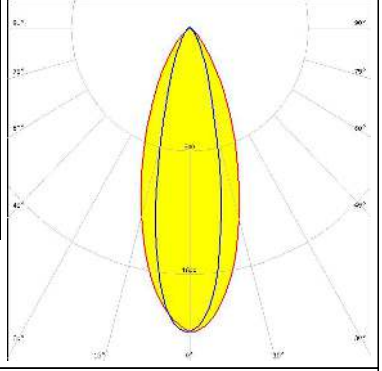
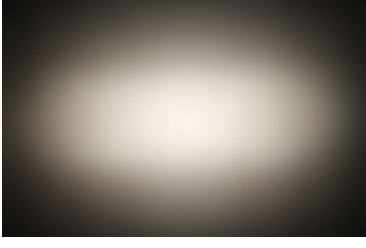
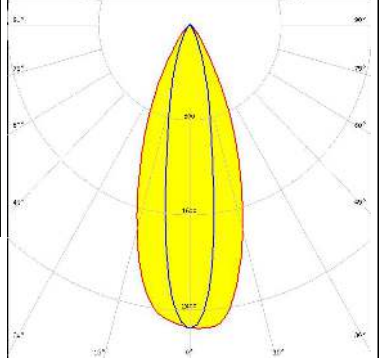

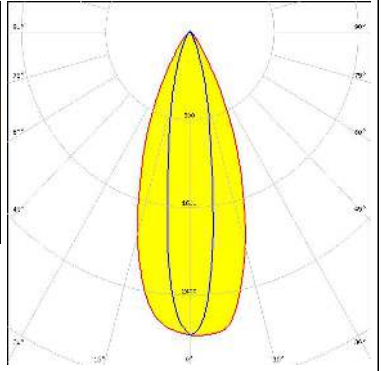

#### OPTICAL RESULTS (MEASURED):

<p><b>LUMILEDS</b></p> <p>LED LUXEON A</p> <p>FWHM / FWTM 39.0 + 26.0° / 78.0 + 55.0°</p> <p>Efficiency 81 %</p> <p>Peak intensity 1.9 cd/lm</p> <p>LEDs/each optic 1</p> <p>Light colour White</p> <p>Required components:</p>		
<p><b>LUMILEDS</b></p> <p>LED LUXEON Rebel</p> <p>FWHM / FWTM 40.0 + 18.0° / 70.0 + 42.0°</p> <p>Efficiency 84 %</p> <p>Peak intensity 2.7 cd/lm</p> <p>LEDs/each optic 1</p> <p>Light colour White</p> <p>Required components:</p>		
<p><b>LUMILEDS</b></p> <p>LED LUXEON Rebel ES</p> <p>FWHM / FWTM 39.0 + 25.0° / 77.0 + 54.0°</p> <p>Efficiency 82 %</p> <p>Peak intensity 2 cd/lm</p> <p>LEDs/each optic 1</p> <p>Light colour White</p> <p>Required components:</p>		
<p><b>LUMILEDS</b></p> <p>LED LUXEON Rebel Plus</p> <p>FWHM / FWTM 40.0 + 19.0° / 69.0 + 46.0°</p> <p>Efficiency 83 %</p> <p>Peak intensity 2.6 cd/lm</p> <p>LEDs/each optic 1</p> <p>Light colour White</p> <p>Required components:</p>		

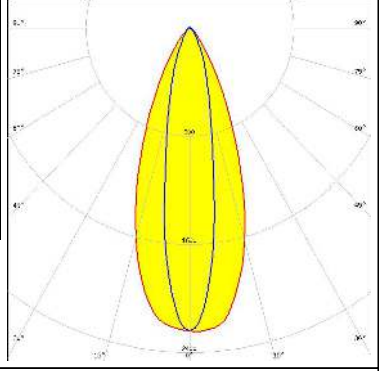
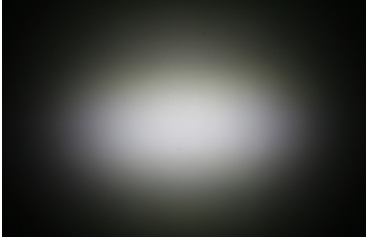

#### OPTICAL RESULTS (MEASURED):

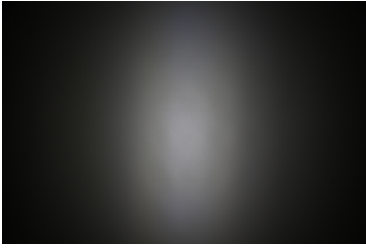
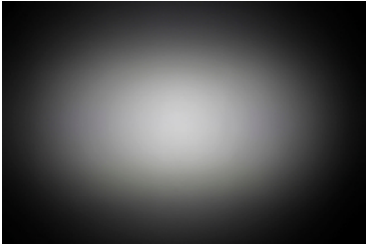
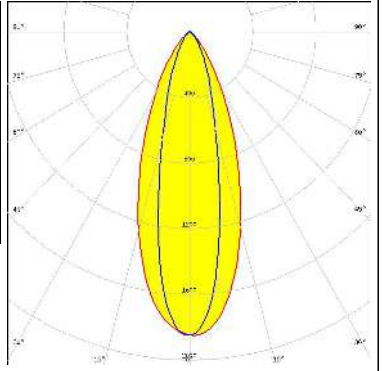
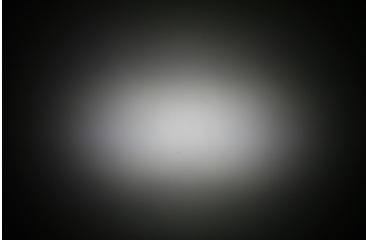
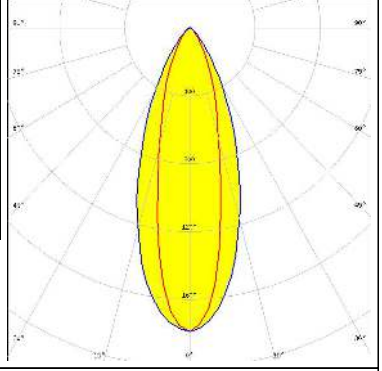
<p><b>LUMILEDS</b></p> <p>LED LUXEON Z</p> <p>FWHM / FWTM 41.0 + 14.0° / 62.0 + 36.0°</p> <p>Efficiency 81 %</p> <p>Peak intensity 3.5 cd/lm</p> <p>LEDs/each optic 1</p> <p>Light colour White</p> <p>Required components:</p>		
<p><b>LUMILEDS</b></p> <p>LED LUXEON Z ES</p> <p>FWHM / FWTM 40.0 + 18.0° / 68.0 + 44.0°</p> <p>Efficiency 86 %</p> <p>Peak intensity 2.8 cd/lm</p> <p>LEDs/each optic 1</p> <p>Light colour White</p> <p>Required components:</p>		
<p><b>NICHIA</b></p> <p>LED NCSxx19A</p> <p>FWHM / FWTM 41.0 + 19.0° / 71.0 + 50.0°</p> <p>Efficiency 81 %</p> <p>Peak intensity 2.3 cd/lm</p> <p>LEDs/each optic 1</p> <p>Light colour White</p> <p>Required components:</p>		
<p><b>NICHIA</b></p> <p>LED NF2x757A</p> <p>FWHM / FWTM 41.0 + 33.0° / 75.0 + 60.0°</p> <p>Efficiency 78 %</p> <p>Peak intensity 2 cd/lm</p> <p>LEDs/each optic 1</p> <p>Light colour White</p> <p>Required components:</p>		

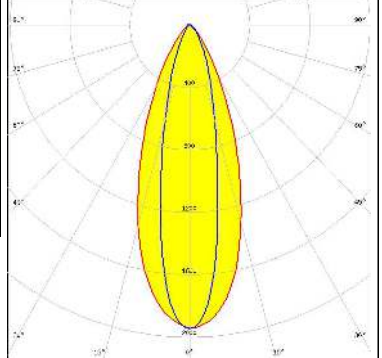
#### OPTICAL RESULTS (MEASURED):

<p><b>NICHIA</b></p> <p>LED NF2x757G</p> <p>FWHM / FWTM 42.0 + 25.0° / 80.0 + 70.0°</p> <p>Efficiency 76 %</p> <p>Peak intensity 1.5 cd/lm</p> <p>LEDs/each optic 1</p> <p>Light colour White</p> <p>Required components:</p>		
<p><b>NICHIA</b></p> <p>LED NVSxx19A</p> <p>FWHM / FWTM 40.0 + 24.0° / 77.0 + 57.0°</p> <p>Efficiency 79 %</p> <p>Peak intensity 1.9 cd/lm</p> <p>LEDs/each optic 1</p> <p>Light colour White</p> <p>Required components:</p>		
<p><b>OSRAM</b> Opto Semiconductors</p> <p>LED Duris S5 (2 chip)</p> <p>FWHM / FWTM 26.0 + 41.0° / 63.0 + 77.0°</p> <p>Efficiency 85 %</p> <p>Peak intensity 1.8 cd/lm</p> <p>LEDs/each optic 1</p> <p>Light colour White</p> <p>Required components:</p>		
<p><b>OSRAM</b> Opto Semiconductors</p> <p>LED OSLON Square EC</p> <p>FWHM / FWTM 40.0 + 22.0° / 74.0 + 55.0°</p> <p>Efficiency 78 %</p> <p>Peak intensity 2 cd/lm</p> <p>LEDs/each optic 1</p> <p>Light colour White</p> <p>Required components:</p>		

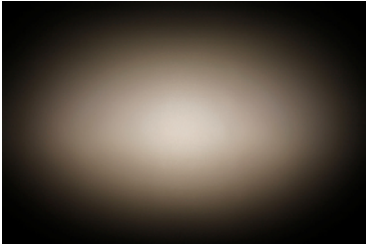
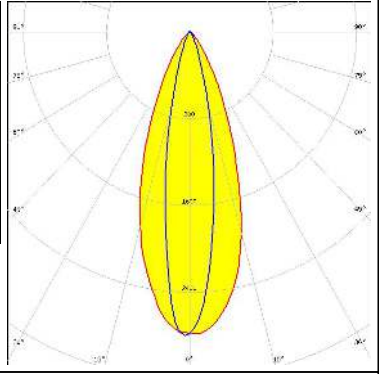
#### OPTICAL RESULTS (MEASURED):

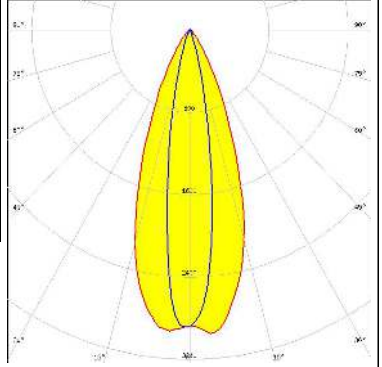
<p><b>OSRAM</b> Opto Semiconductors</p> <p>LED OSLON SSL 150</p> <p>FWHM / FWTM 39.0 + 19.0° / 70.0 + 40.0°</p> <p>Efficiency 84 %</p> <p>Peak intensity 2.9 cd/lm</p> <p>LEDs/each optic 1</p> <p>Light colour White</p> <p>Required components:</p>		
<p><b>OSRAM</b> Opto Semiconductors</p> <p>LED OSLON SSL 80</p> <p>FWHM / FWTM 40.0 + 17.0° / 70.0 + 48.0°</p> <p>Efficiency 77 %</p> <p>Peak intensity 2.5 cd/lm</p> <p>LEDs/each optic 1</p> <p>Light colour White</p> <p>Required components:</p>		

#### OPTICAL RESULTS (SIMULATED):

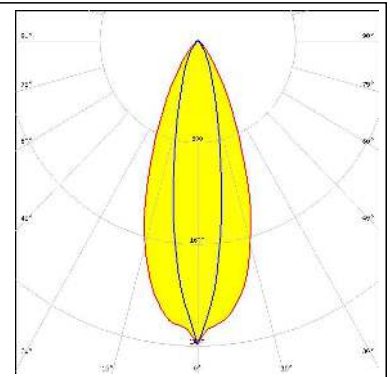
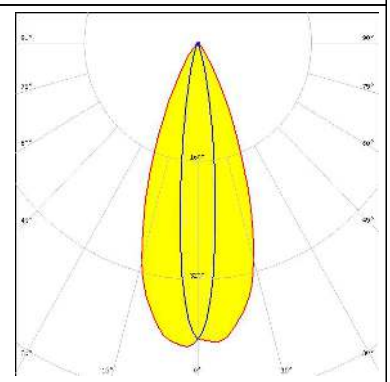
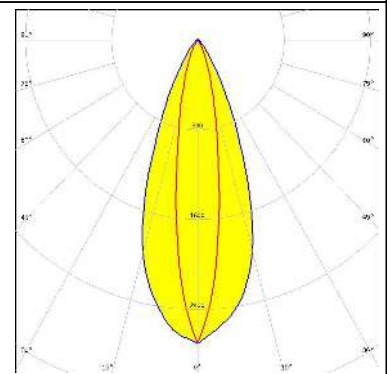
<p><b>CREE</b> LED</p> <p>LED: J Series 2835            FWHM / FWTM: 40.0 + 19.0° / 72.0 + 50.0°            Efficiency: 82 %            Peak intensity: 2.4 cd/lm            LEDs/each optic: 1            Light colour: White            Required components:</p>	
<p><b>CREE</b> LED</p> <p>LED: XQ-E HI            FWHM / FWTM: 40.0 + 14.0° / 64.0 + 29.0°            Efficiency: 89 %            Peak intensity: 4.1 cd/lm            LEDs/each optic: 1            Light colour: White            Required components:</p>	
<p><b>NICHIA</b></p> <p>LED: NCSxE17A            FWHM / FWTM: 18.0 + 40.0° / 42.0 + 68.0°            Efficiency: 79 %            Peak intensity: 2.7 cd/lm            LEDs/each optic: 1            Light colour: White            Required components:</p>	



### GENERAL INFORMATION:

NOTE: The typical beam angle will be changed by different color, chip size and chip position tolerance. The typical total beam angle is the full angle measured where the luminous intensity is half of the peak value.

### MATERIALS:

As part of our continuous research and improvement processes, and to ensure the best possible quality and availability of our products, LEDiL reserves the right to change material grades without notice.

### PRODUCT DATA USER AGREEMENT AND DISCLAIMER:

The measured data in the provided downloadable LEDiL Product Datasheets and Mechanical 2D-Drawings is rounded and provided as reference for planning. LEDiL Oy's optical specifications have been verified by conducting performance testing of the products in accordance with the company's quality system. The reported data are averaged results of multiple measurements with typical variation. LEDiL Oy reserves the right to without prior notification make changes and improvements to its products.

LEDiL Oy assumes neither warranty, nor guarantee nor any other liability of any kind for the contents and correctness of the provided data. The provided data has been generated with highest diligence but the provided data may in reality not represent the complete possible variation range of all intrinsic parameters. Therefore, in certain cases a deviation from the provided data could occur.

LEDiL Oy reserves the right to undertake technical changes of its products without further notification which could lead to changes in the provided data. LEDiL Oy assumes no liability of any kind for the possible deviation from any provided data or any other damage resulting from the usage of the provided data.

The user agrees to this disclaimer and user agreement with the download or usage of the provided files.

#### LEDiL Oy

Joensuunkatu 13  
FI-24240 SALO  
Finland

#### LEDiL Inc.

228 West Page Street  
Suite D  
Sycamore IL 60178  
USA

#### Ledil Optics Technology (Shenzhen) Co., Ltd.

# 405 , Block B  
Casic Motor Building  
Shenzhen 518057  
P.R.CHINA

#### Local sales and technical support

[www.ledil.com/  
where\\_to\\_buy](http://www.ledil.com/where_to_buy)

#### Shipping locations

Salo, Finland  
Hong Kong, China

#### Distribution Partners

[www.ledil.com/  
where\\_to\\_buy](http://www.ledil.com/where_to_buy)